

**Gosmilo**

*SURFING ON WHEEL*



## WELCOME TO THE Gosmilo'S WORLD

### WELCOME TO JOIN THE Gosmilo family

Congratulations on the purchase of your new Gosmilo one wheel surfing scooter and welcome to become the Gosmilo rider. We want to keep you safe while you experience a new sport.

You control it with your body weight via the footpad sensors. Once you get the hang of it, it's very easy to control. It almost feels like an extension of yourself, which is a cool feeling.

In the user's manual, we'll share important safety performance and service information with you.

Please read it before your first ride.

( USER'S MANUAL )



00 PREFACE	03 .....12
01 SAFETY OVERVIEW	13 .....14
02 GETTING TO KNOW YOUR Gosmilo one wheel	15 .....20
03 RIDING YOUR Gosmilo one wheel	21 .....40
04 MORE WAYS TO RIDE SAFETY	41 .....48
05 MAINTENANCE AND WARRANTY	49 .....62



## TABLE OF CONTENTS

## STRUCTURE

MAIN STRUCTURE:

- a . Power Switch
- b . LED Lights
- c . Charging Port
- d . Foot Pad

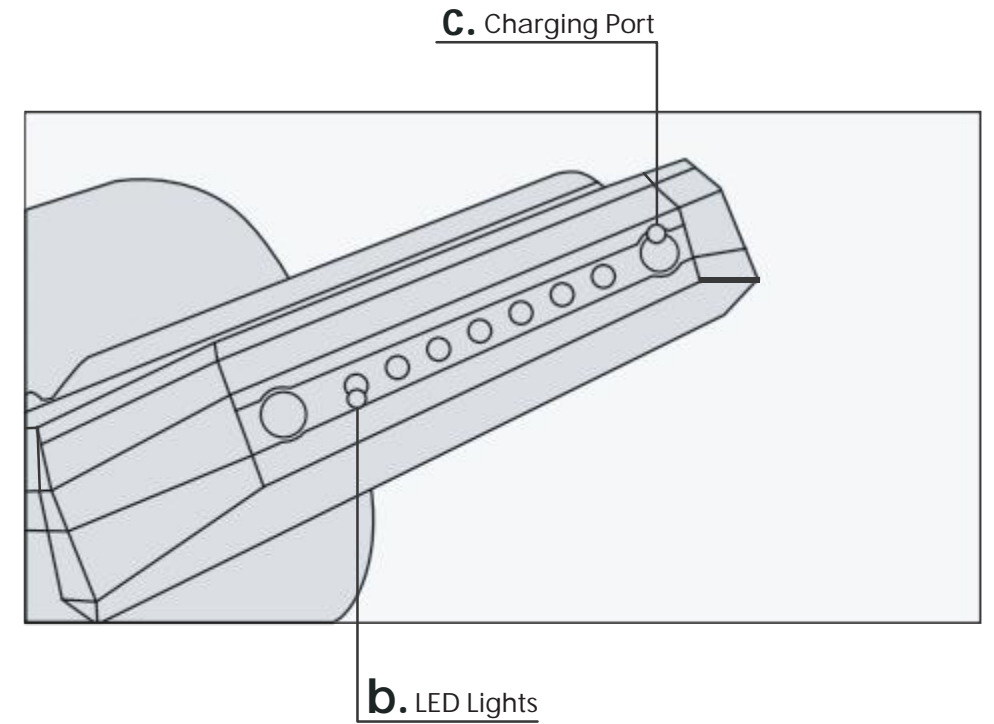
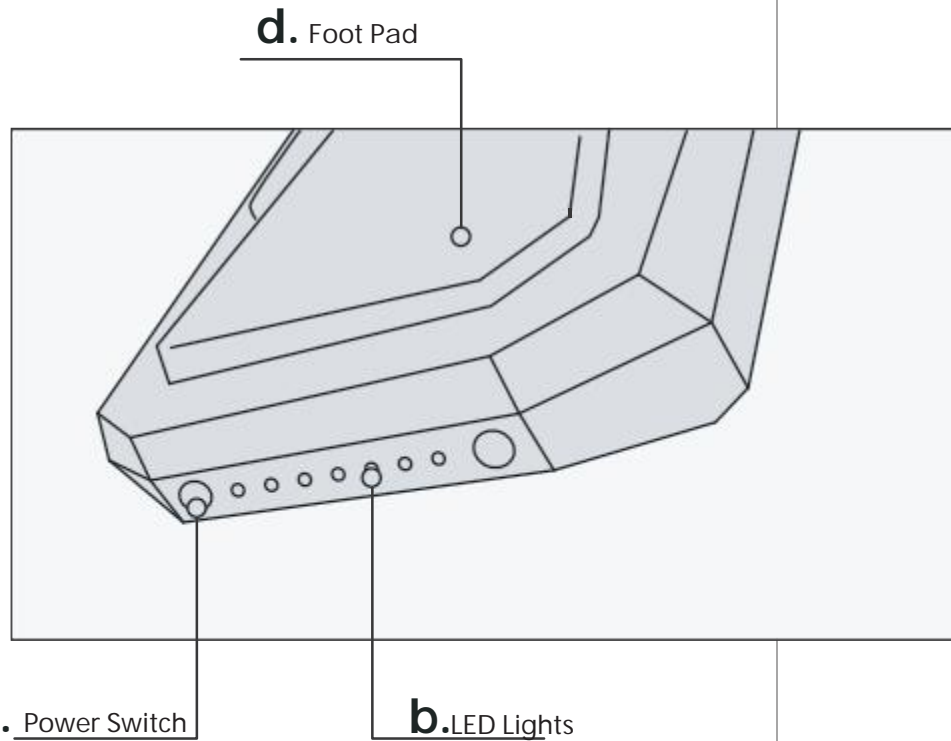

 **Warning:** Max Load: 125kg!





## ⚠️ WARNING ⚠️

RISK OF DEATH OR SERIOUS INJURY

---

Whenever you ride Gosmilo one wheel board, you risk death or serious injury from loss of control, falls or collision. For safety reasons, you must read and comply with all instructions and warnings in the user manual.

## DOWNLOAD THE APP

The Gosmilo focstrot controller is based upon the VESC® -Project . VESC is a registered TM, owned by Benjamin Vedder.

Sync to your Gosmilo one wheel board by app (VESC Tool)to enjoy your riding.

TIP: Search"VESC Tool"on Google Play or Apple App Store.



### Note:

The focstrot controllers are pre-programmed and plug and play. Please don't modify the configures which may cause the board failure.Any modification please contact and guide by Gosmilo.

## GENERAL WARNING

---

Like any sport, there is a risk of injury when using Gosmilo one wheel. By choosing Gosmilo, you have chosen to assume this risk.

It is important for you to understand and practice safety rules, as well as the use and maintenance of Gosmilo, to reduce the risk of injury.

Regarding the importance of safe use and proper maintenance and inspection of your Gosmilo one wheel.

This manual contains many 'Warnings' and 'Cautions'. Any boardsports has unpredictable or unavoidable risks, These risks are responsibility of the players.



**Warning:** Indicates a potential hazardous situation that, if not avoided result in serious injury or death.



**Cautions:** Refers to potential hazardous situations or unsafe practices that, If not avoided, may result in minor or moderate injury, serious damage to your Gosmilo one wheel and void your warranty.



**Tips:** Indicates information to help you use your Gosimlo one wheel better.

Protective gear and a helmet should always be worn when riding! Follow all local laws and ordinances, and pay attention to your surroundings at all times. The manufacturer and seller bear no responsibility for any property loss, personal casualty, accident, or legal dispute caused by use or misuse of this product. In riding the Gosmilo one wheel, the user assumes all related risks involved.

### SPECIAL NOTE TO PARENTS AND GUARDIANS

As a parent or guardian, you are responsible for the activities and safety of your minor or child (while he or she is operating a Gosmilo). Please ensure that their Gosmilo one wheel is in good repair and safe operating condition and that your child understands its proper use. It is also important that both you and your child learn, understand, and obey all applicable local motor vehicle and traffic laws. Always make sure your child is wearing proper protective equipment, including a helmet and wrist guards. Gosmilo IS NOT RECOMMENDED FOR CHILDREN UNDER THE AGE OF 18. FOR CHILDREN 18 YEARS OF AGE AND OLDER, ADULT SUPERVISION IS REQUIRED.



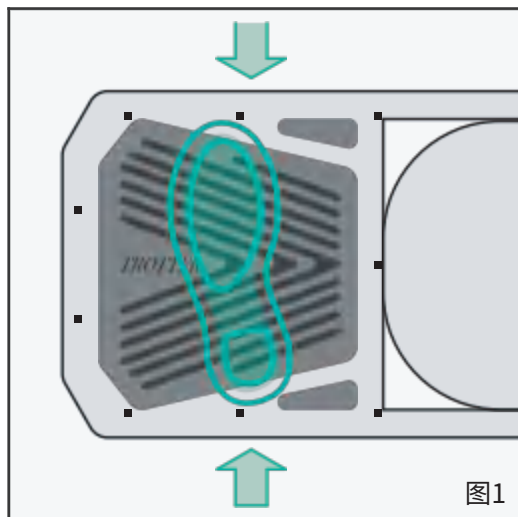

## 01

Turn on the power switch located on the side. Stand up with your foot fully, with the foot located in the center of the foot pad.

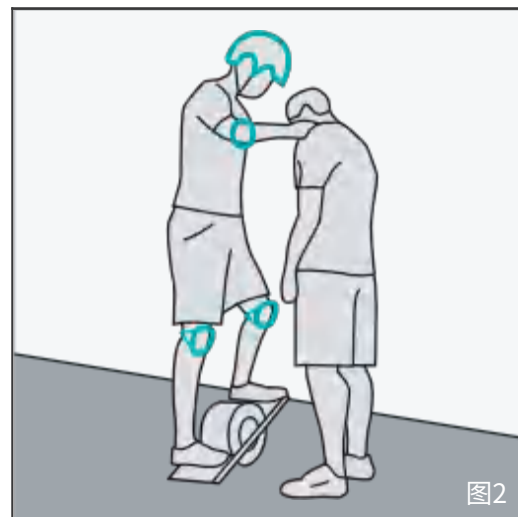

## 02

Helmet protection must be worn before use. Let friend help you for first ride. Try to achieve balance slowly.

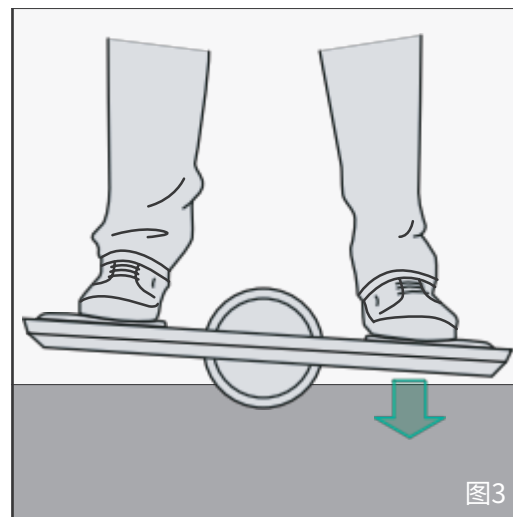

## 03

When both feet come into contact with the foot pads, Gosmilo will engage when you reach a horizontal orientation. Lean forward to accelerate, Lean back to slow down, and lean left or right to turn.

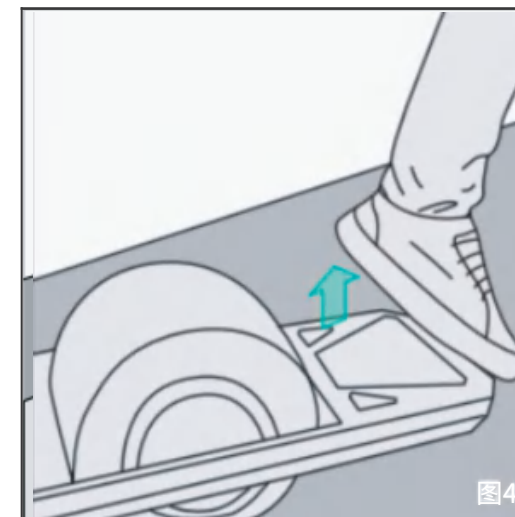

## 04

When decelerating to  $<1.5\text{km/h}$ , step on the frame of the footpad with your toes, and lift the sole and heel off the foot pad. You can also jump off with both feet, but don't just move one foot.



# 01 SAFETY OVERVIEW

## SAFETY RIDING

Whether you are a professional or a new rider, safe use is always important. Here are some suggestions to ensure the safety of you and your Gosmilo one wheel.

## Helmet

When using Gosmilo, always wear a helmet that meets GB 24429-2009, ASTM F1492-08, CPSC, and/or CE EN1078 certification standards.

## Shoes

Be sure to wear proper and anti-skid sports shoes, and never ride barefoot or wear flip-flops.

## Other protective equipment

Be sure to wear wrist elbow, and knee protectors to make riding safer. Refer to Section 04 "More Ways to Ride Safety"





**Warning:** It is your responsibility to familiarize yourself with and comply with local traffic laws and regulations. Do not use Gosmilo one wheel on public roads and wear safety gear at all times.

## POWER SWITCH

---

The Gosmilo one wheel is powered ON or OFF by a switch button on one side. Please ensure that your Gosmilo remains in the correct position on the ground- before turning on the switch button. Be sure to turn off the power switch when charging, storing, or carrying.

 **Warning:** Do not pick up Gosmilo one wheel when the power is turned on, as the wheels may rotate and cause you to be injured.

 **Cautions:** When charging Gosmilo, do not press the sensing area of the foot pad, otherwise it will not work.

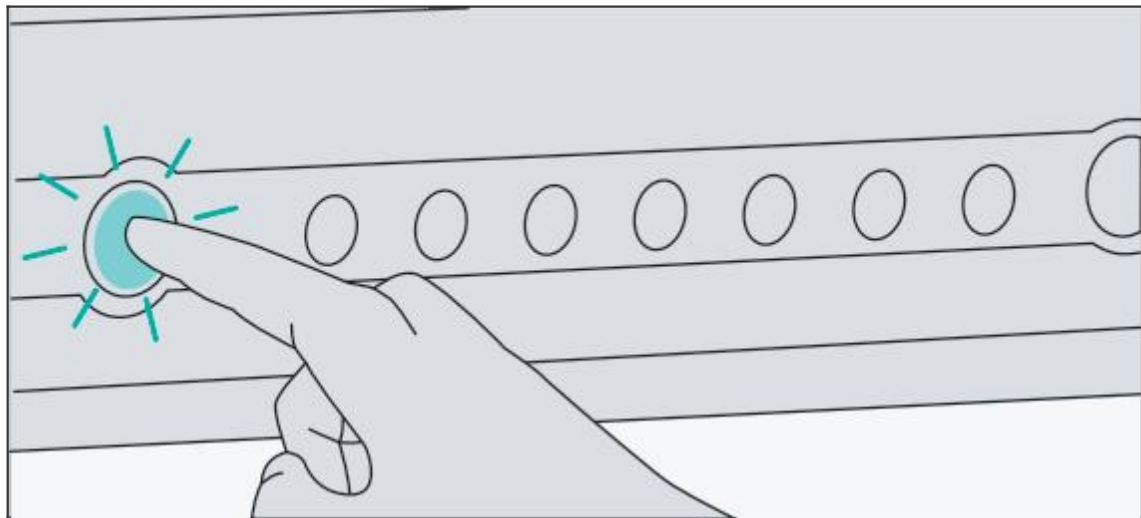

## STATUS INDICATOR

---

### NORMAL OPERATION

When turn on, the front LED lights is white and the other side are red, no blink and alarming .

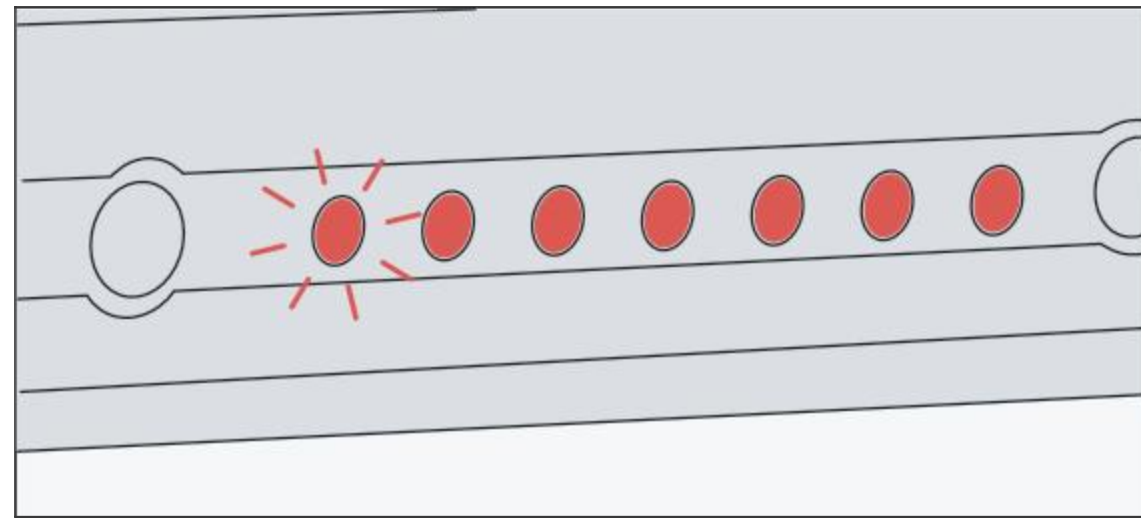

## Gosmilo SPECIFICATIONS

MODEL:	X1
MOTOR:	700W HUB MOTOR
BATTERY:	LITHIUM 48V 5.2Ah 13S2P
SENSORS:	DUAL OPTOELECTRONIC SENSOR
TIRE:	11IN*6.0-5.5
MAX LEAN ANGLE:	45°
TOP SPEED:	20Km/h
TYPICAL RANGE:	18-25Km
DIMENSIONS:	736*259*280mm
WEIGHT:	13.9kg
RECHARGE TIME:	2-3hours
MAX LOADING:	120KGS
INPUT:	AC100 - 240V 50/60Hz
OUTPUT:	+54.6V DC 2A
OPERATING TEMPERATURERANGE:	0-40°C
OPERATING HUMIDITY RANGE:	0~100% RH

## CHARGER SPECIFICATIONS

MODEL:	X1+
MOTOR:	700W HUB MOTOR
BATTERY:	LITHIUM 10Ah 13S3P
SENSORS:	DUAL OPTOELECTRONIC SENSOR
TIRE:	11IN*6.0-5.5
MAX LEAN ANGLE:	45°
TOP SPEED:	20Km/h
TYPICAL RANGE:	40-45Km
DIMENSIONS:	736*259*280mm
WEIGHT:	14.5kg
RECHARGE TIME:	4-6hours
MAX LOADING:	120KGS
INPUT:	AC100 - 240V 50/60Hz
OUTPUT:	+54.6V DC 2A
OPERATING TEMPERATURERANGE:	0-40°C
OPERATING HUMIDITY RANGE:	0~100% RH

## Gosmilo SPECIFICATIONS

MODEL:	X3
MOTOR:	1000W HUB MOTOR
BATTERY:	LITHIUM 60V 7Ah 16S2P
SENSORS:	DUAL OPTOELECTRONIC SENSOR
TIRE:	11IN*6.0-5.5
MAX LEAN ANGLE:	45°
TOP SPEED:	28Km/h
TYPICAL RANGE:	30-40Km
DIMENSIONS:	736*259*280mm
WEIGHT:	14.9kg
RECHARGE TIME:	3-4hours
MAX LOADING:	120KGS
INPUT:	AC100 - 240V 50/60Hz
OUTPUT:	+67.2V DC 2A
OPERATING TEMPERATURERANGE:	0-40°C
OPERATING HUMIDITY RANGE	0~100%RH

## CHARGER SPECIFICATIONS

MODEL:	X5
MOTOR:	1500W HUB MOTOR
BATTERY:	LITHIUM 60V 7Ah 16S2P
SENSORS:	DUAL OPTOELECTRONIC SENSOR
TIRE:	12IN*6.0-7
MAX LEAN ANGLE:	45°
TOP SPEED:	35Km/h
TYPICAL RANGE:	30-40Km
DIMENSIONS:	771*259*310mm
WEIGHT:	16.5kg
RECHARGE TIME:	3-4hours
MAX LOADING:	125KGS
INPUT:	AC100-240V 50/60Hz
OUTPUT:	+67.2V DC 2A
OPERATING TEMPERATURERANGE:	0-40°C
OPERATING HUMIDITY RANGE	0~100% RH



## 03 RIDING Gosmilo one wheel

### BRAND NEW CHALLENGE

Whether you're a professional player or a beginner, Gosmilo help you get a lot of fun .

Gosmilo is desgined to be intuitive .Anyone can learn the basics in just a few minutes. Once you start riding regularly, there is plenty of room to challenge yourself.

Always do a safety check before each ride  
Read all safety instructions .  
Wear a helmet and other protective gear .

Choose a safe,controlled and calm environment away from cars,crowds,obstacles and other potential hazards .

## BASIC BALANCE

Remember Gosmilo one wheel is self-balancing so there's no need to muscle your way onto the board. Instead, use slow, small movements

- ✓ **Tips:** Have a friend's shoulders handy to help you the first few times you get on your board.
- ✓ **Tips:** Look where you want to go. Don't look down
- ✓ **Tips:** use light, constant pressure to control your Gosmilo
- ✓ **Tips:** Don't bend your knees, rather stand tall on your first rides.



Place a Gosmilo on the ground, step one foot on a pad, put another foot on another pad, now the board powered on, keep your legs straight (as standing on the ground), bending your knees slightly.

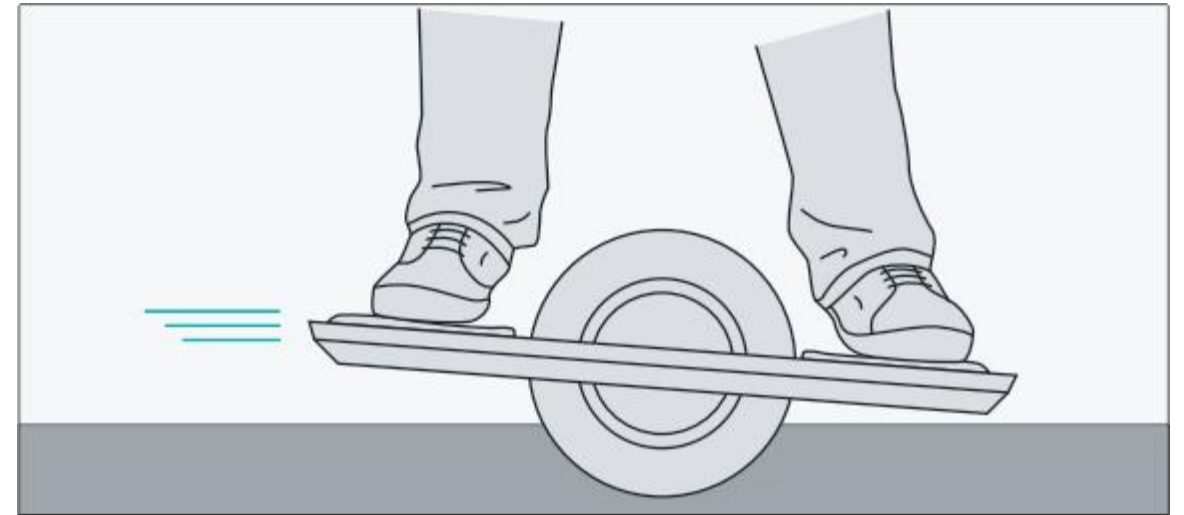



## UNDERSTANDING THE FOOTPAD

---

Gosmilo pads are pressure sensitive, two feet on pads both, power on. Slow it down, remove one foot from the sensitive zone, it stops.

✓ **Tips:** Avoid moving your foot while riding.

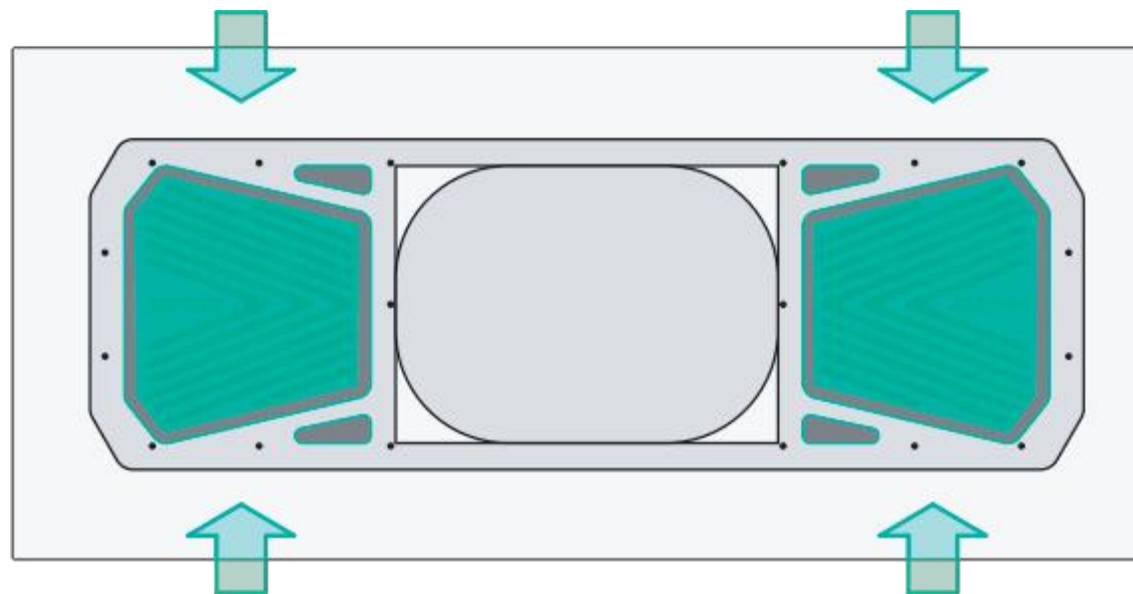

## DIRECTION AND SPEED

---

Lean forward to move forward, and lean back to slow down or to move backwards. The more you lean, the faster you'll go.

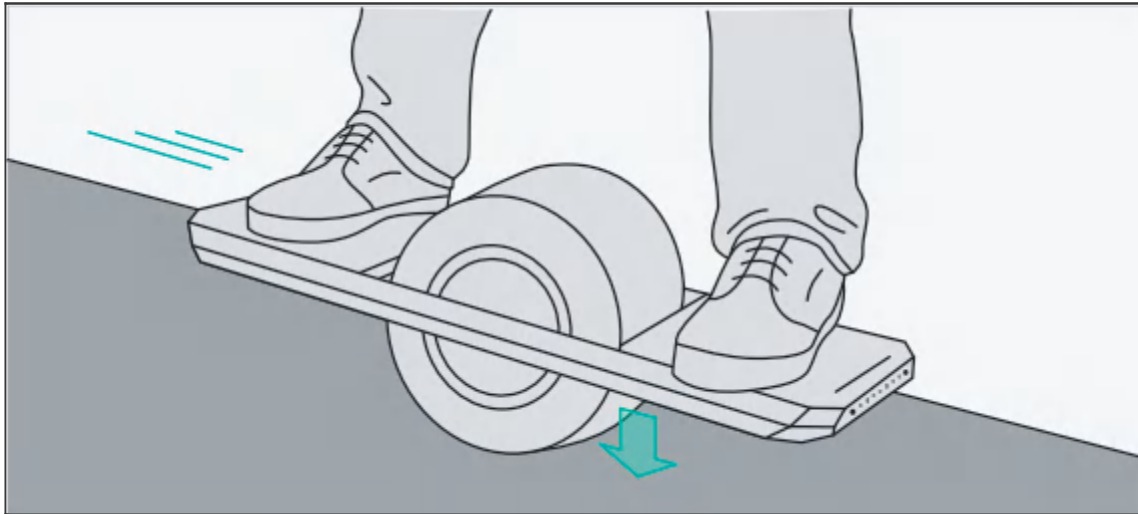

## TURNING

---

Use subtle heel- toe pressure for turning left or right. You will begin to turn in the direction you lean. The more you lean, the sharper the turn.

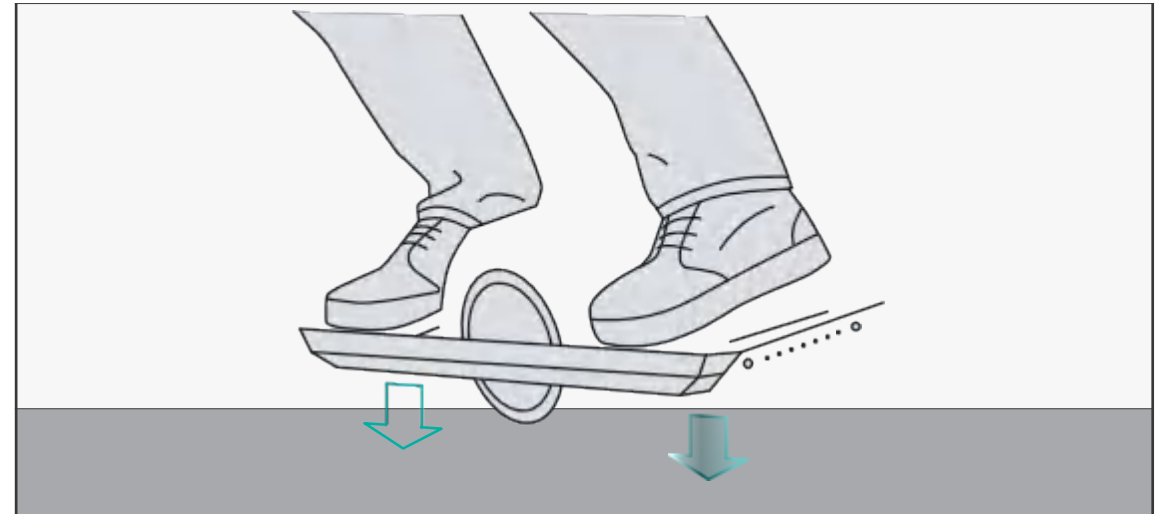



## RANGE

---

Range varies on an assortment of factors including rider weight and riding style, terrain, inclines and declines and tire pressure. For optimal range, we recommend the following tips:

- ✓ **Tips:** Fully charge your Gosmilo.
- ✓ **Tips:** Ensure the tire pressure 35-40psi \* (Tire to the frame 5mm)
- ✓ **Tips:** In winter, the range will be reduced because lithium-ion batteries degrade faster at low temperatures. Please notice.

\* Gosmilo tire is explosion - proof, no need to worry about blowouts .  
\* Tire pressure makes a significant difference to Gosmilo range, top speed and ride quality . Even a few PSI change can alter the ride.

## DISMOUNT

---

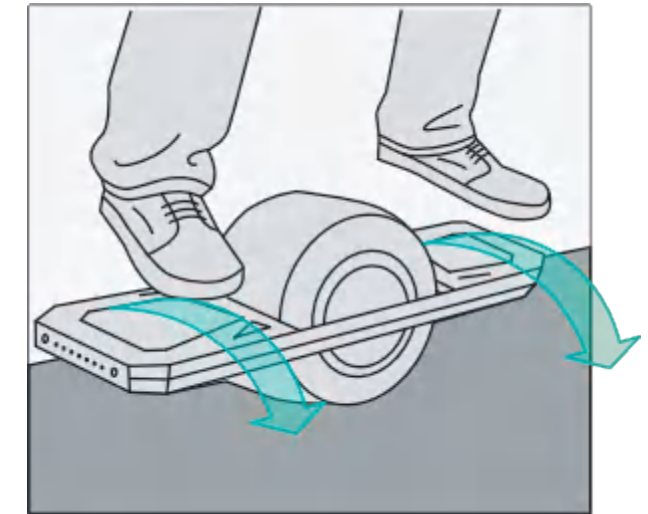
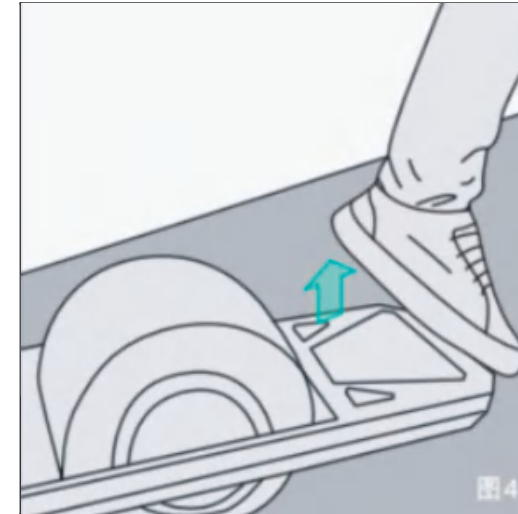

When you're done riding, slow down by leaning back. After maintaining balance, lift your heel off the sensing area or jump off with both feet.

- ✓ **Tips:** TIP: Both feet must be stepped on the foot pads at the same time to start riding. Gosmilo will stop if you slow down and move one foot away from the sensing area on one side.



## SPEED LIMIT PROTECTION

If at any time you attempt to go too fast, descend a steep hill or ride with low battery, The front of Gosmilo will lift up and pushback to remind players to slow down. The only way to avoid this situation is to slow down by leaning back.

-  **Warning:** Ignoring safety warnings, including deceleration warnings, may lead to loss of control, serious injury, or death.
-  **Warning:** Do not attempt to ride down a long or steep hill with fully charged Gosmilo as it may lose control or damage.
-  **Warning:** Continuing to ride with low battery may cause Gosmilo to suddenly shut down or damage.

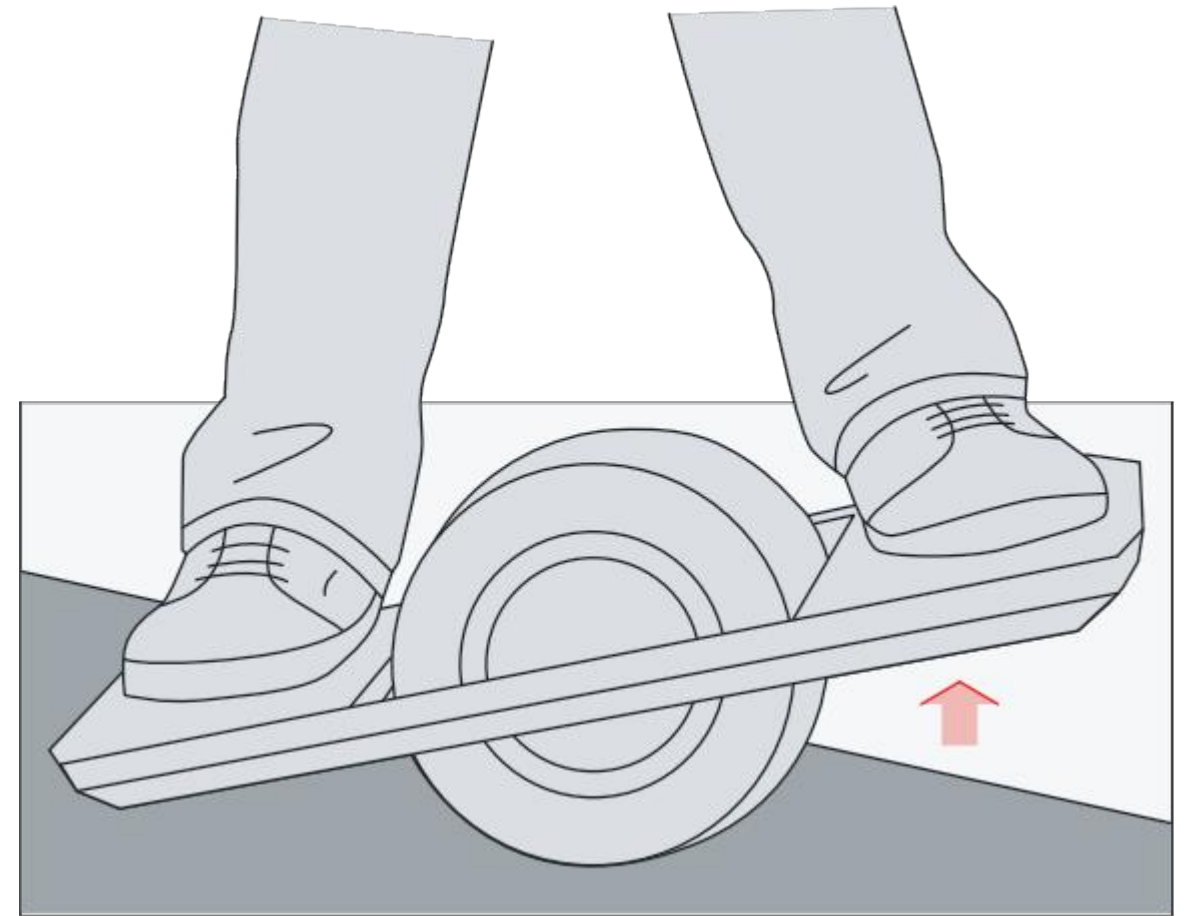

## DECELERATION WARNING

Deceleration warning is very important, ignoring or continuing to accelerate is very dangerous



**Cautions:**

Deceleration warning  
The front of the board is lifting up, remind the rider to slow down.

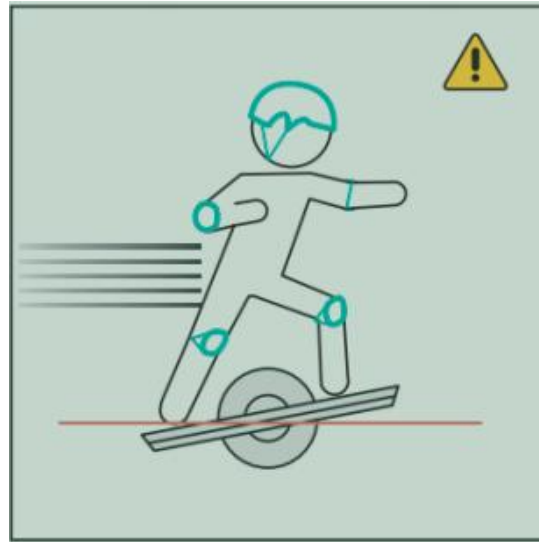

**Cautions:**

Deceleration warning  
The rider is aware of the warning and plans to make adjustments.

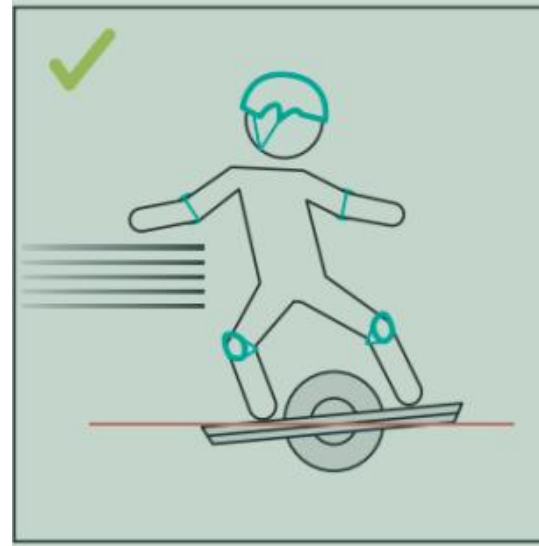

**Tips:**

The rider shifts the weight to back foot in order to slow down.

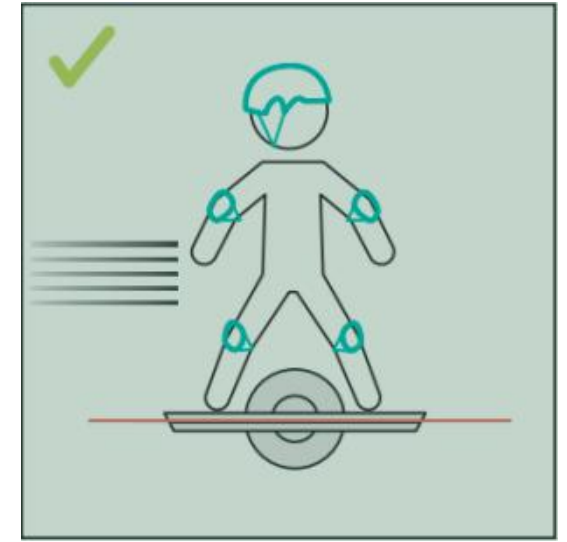

**Tips:**

The rider has slowed down, the board returns to normal riding.

## DECELERATION WARNING

Deceleration warning is very important, ignoring or continuing to accelerate is very dangerous



 **Cautions:**  
Front end lifting  
The front of the board is lifting up, remind the rider to slow down.

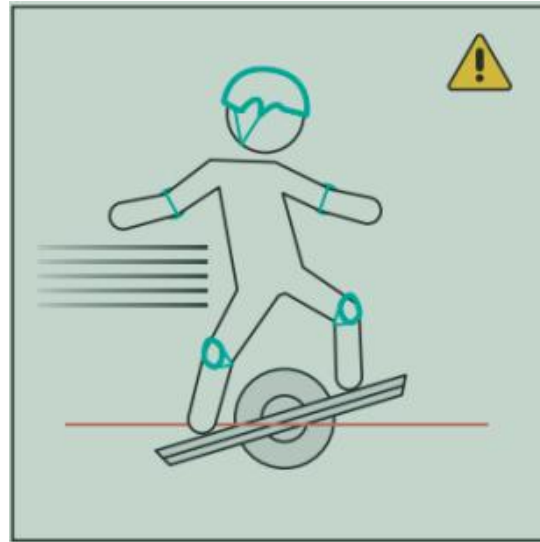

 **Warning:**  
Never ignore warning  
If the rider keep leaning front, the board will continue to lifting up.



 **Warning:**  
Never ignore warning  
The rider keep leaning front, the board continue to lifting up.

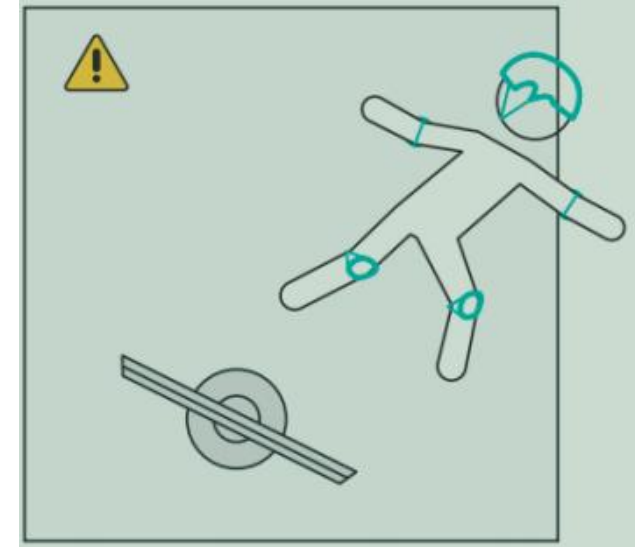

 **Warning:**  
Never ignore warning  
Ignore safety warnings can lead to loss of control, serious injury, or death.



## BATTERY CHARGER

Use only the official charger provided to charge your Gosmilo. The charger connected to the board for several days will not cause damage. But for long-term storage it needs to be stored according to the long-term storage instructions.

1. The charger connected to the board for several days will not cause damage.
2. Do not connect the charger to the board for several months of storage

 **Cautions:** Use only the official charger provided to charge your Gosmilo. Use of any other charger will void your warranty and may damage your Gosmilo.

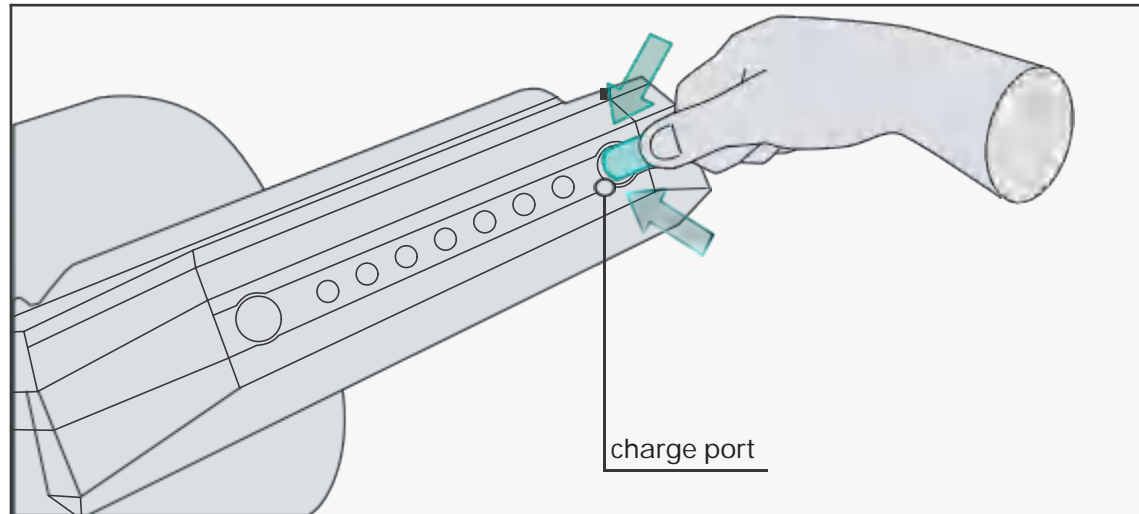

## HOW TO CHARGE YOUR BATTERY

01. Connect the charger to an "AC" supply, the charger will display light.
02. When the battery is fully charged, green light will appear.
03. Disconnect the charger to stop charge.

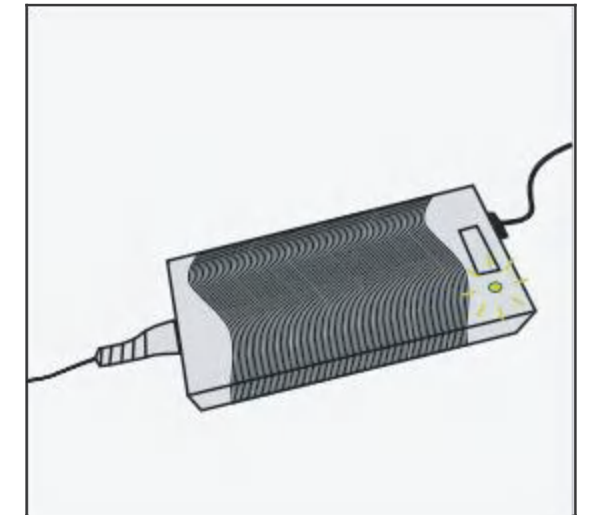
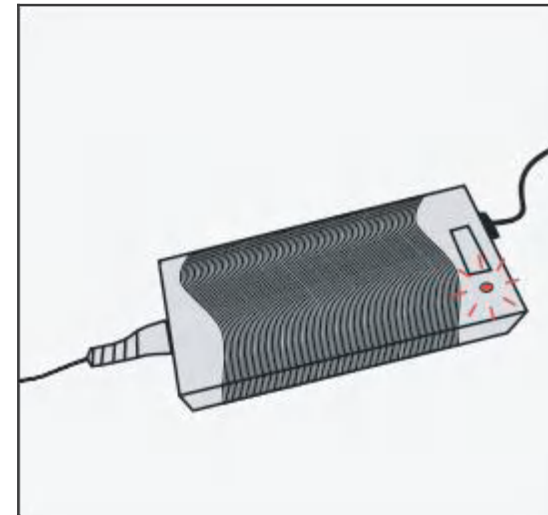

## CHANGE

**!** **Cautions:** Put the charger plug into the charging hole before the AC power on, otherwise the charger will not start, which can avoid potential risks and make charging safer.

**!** **Cautions:** Under normal circumstances, it only takes about 120 minutes to complete the charge, and it takes 60 minutes to charge to 50%. When the indicator light is red, it means that it is charging, and when it turns green, it means charge finished.

**!** **Cautions:** If not urgent, please wait for the end of charging before removing the charger, because the battery protection board will maintain the voltage balance of the battery in the later charging period.

**!** **Cautions:** For long-term storage, charge it 40-50% and check it once a month.

**!** **Cautions:** All electronic and drive components can only be repaired through Gosmilo's authorized service centers. Any other adjustments will void your warranty.

**!** **Cautions:** Do not make any repairs or adjustments to your Gosmilo unless you know how to operate it very well. Improper adjustments or repairs may cause damage to your Gosmilo or cause injury. Complex maintenance and repairs need to be done by professionals who are fully equipped.

**!** **Cautions:** Indicator light on the charger is red, it means it is charging.

**!** **Cautions:** Indicator light on the charger is green, it means the end.

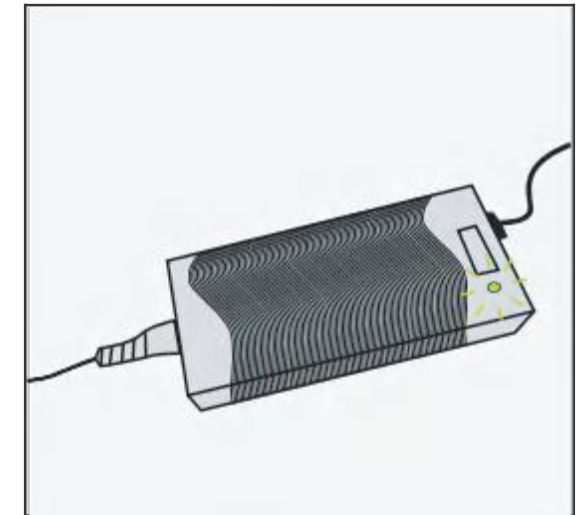
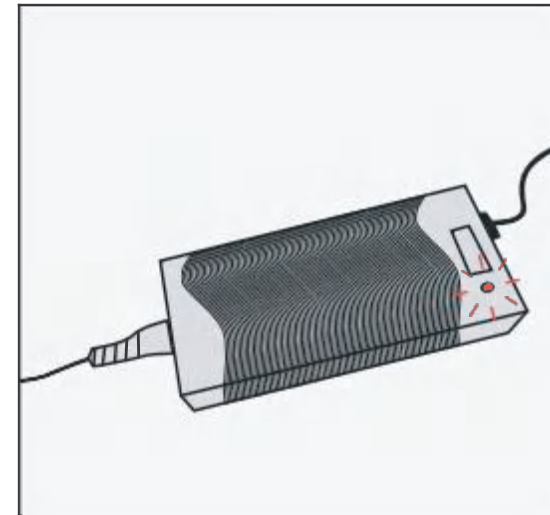

# O4 MORE WAYS TO RIDE SAFELY

Be sure not to modify your Gosmilo  
Gosmilo is pretty much perfect as is. So there is no need to add any extra bells  
and whistles.

Modifying or changing the appearance or performance of your Gosmilo is  
not advised and could potentially increase your risk of injury.

If you have specific questions, please contact Gosmilo customer service:  
[service@smilomotors.com](mailto:service@smilomotors.com)



**Warning:** Failure to confirm the compatibility of, or to properly install, operate or  
maintain any component or accessory on your Gosmilo can result in serious  
injury or death and will void your warranty.





**Cautions:** Changing or modifying any Gosmilo one wheel factory component will void  
your warranty.

## MORE WAYS TO RIDESAFELY(ONE)

---

Observe all local traffic laws and regulations regarding riding on side walks and trails. It is your responsibility to know and obey the laws in your riding area. Share the road and respect the rights and safety of other motorists, pedestrians and cyclists.

 **Warning:** Never ride your Gosmilo on inclines or declines with grades steeper than 20%. This may cause the motor and battery to overheat and will also void your warranty.

 **Cautions:** Jumping and stunt riding will void your warranty.

LOOKAHEAD, AND BE READY TO AVOID OR YIELD TO:

Vehicles slowing or turning, entering your lane ahead of you or coming up behind you

Parked cars or opening car doors

Pedestrians

Children or pets

Pot holes, sewer grating, railroad tracks, expansion joints, road or sidewalk construction, debris and other obstructions that could cause you to swerve into traffic, catch your wheel or fall.

## MORE WAYS TO RIDESAFELY(TWO)

---

### ALWAYSWEAR:

Shoes that stay on your feet and will grip the board. Never ride barefoot or while wearing sandals or flip-flops.

Bright clothing that makes you clearly visible to drivers, riders and pedestrians.

Protective eye wear to protect against the sun, as well as airborne dirt, dust and, of course, bugs.



**Warning:** Failure to wear a helmet when riding may result in serious injury or death.

Always wear a 24429 - 2009, ASTM F1492 - 08, CPSC and/or CE EN1078 and/or CE EN1078 certified helmet, and follow the manufacturer's instructions for fit, use and care. Head injuries are some of the most serious and maybe avoided with proper protection.

Avoid sharp bumps, drainage grates and sudden surface changes.

Avoid streets and surfaces with water, sand, gravel dirt, leaves and other debris.

Wet weather impairs traction, braking and visibility.

Never ride near motor vehicles.

Always ride in designated lanes or paths or as close to the edge of the road as possible in the direction of traffic flow or as directed by local laws.

Never weave through traffic.

Never carry a passenger

Never carry anything that could obstruct your vision or that could cause you or your clothing to become entangled in the wheel.

Never hitch a ride holding onto another moving vehicle or object.

Never ride your Gosmilo while under the influence of alcohol or drugs.

Choose smooth stable paths made of concrete and asphalt.

Observe and yield the right of way.

## MORE WAYS TO RIDESAFELY(THEE)

---

Do not perform racing, stunt riding or other maneuvers that may cause loss of control.

Do not allow body parts, clothes, etc. to come into contact with moving parts, wheels or drive train while the motor is running.

Before each use,perform pre-operation checks as specified by the manufacturer.

The owner shall allow use of the unit only after clearly demonstrating its proper and safe use and confirming that the operator understands alicomponents and aspects of operation of the unit,and is wearing a helmet.

Be thoroughly familiar with the way your Gosmilo works (e.g.. speed,direction, turning.

Always keep body parts, clothing and other objects away from the wheel.

Always do a mechanical safety check before getting on your Gosmilo.

When riding,be aware of your environment.Ride at a speed appropriate for your conditions.Increased speed equals higher risk.

Do not ride at night or during times of low visibility[e.g. fog, rain, dusk,dawn).

Follow all manufacturer's recommendations and instructions, as well as comply with all laws and ordinances.

Components shall be maintained and repaired in accordance with manufacturer's specifications.Only authorized replacement parts shall be used. And installation shall be by dealers or other skilled persons.

Persons with heart conditions, pregnant women.persons with head/back/neck ailments.persons with mental or physical conditions that make them susceptible to injury, and persons with impaired capabilities should not operate.



# 05 MAINTAINING YOUR Gosmilo one wheel

## SAFETY CHECK

Doing regular safety checks will help prolong the life of your Gosmilo. We recommend that you carefully inspect your Gosmilo before every ride to make sure that there are no loose, damaged or unusually worn parts.

All nuts and bolts should be tight. Most Gosmilo components were designed so that they can be easily replaced if there is a problem.



**Warning:** Before performing any minor work on your Gosmilo, make sure the power switch is in the "OFF" position.

CONTACT Gosmilo CUSTOMER SERVICE IF YOU HAVE QUESTIONS OR  
EMAIL TO [service@smilomotors.com](mailto:service@smilomotors.com)

## FOOTPADS

---

Inspect footpads for any cracks, punctures or tears in the grip tape, particularly in the rider-detection area. If you notice any damage, contact [service@smilomotors.com](mailto:service@smilomotors.com) for replacement parts.

 **Warning:** Riding with a damaged footpad is extremely dangerous. Replace immediately.

 **Warning:** The footpads are an integral part of the safety system for the Gosmilo. Never ride with damaged wood or grip tape, and never attempt to replace grip tape. Replacement foot pads are available at [www.smilomotors.com](http://www.smilomotors.com) or Gosmilo amazon shop.

 **Cautions:** Riding a damaged Gosmilo will void its warranty

## TIRE

---

Check your Gosmilo one wheel tire for any cuts in the tread and sidewall. Also be sure it is sufficiently inflated up to 35-40 PSI. The best way to check and inflate your Gosmilo one wheel tire is with a quality digital gauge and compressor at your local gas station. If your tire is damaged or has a hole, please contact our customer service for more information; [service@smilomotors.com](mailto:service@smilomotors.com)

 **Warning:** Exceeding the recommended maximum pressure of 40PSI could damage your Gosmilo and result in injury. It will also void your warranty.

 **Cautions:** Riding Gosmilo with a flat or under-inflated tire will void your warranty.

 **Cautions:** Pencil-type automotive tire gauges can be inaccurate. Always use a quality digital gauge.

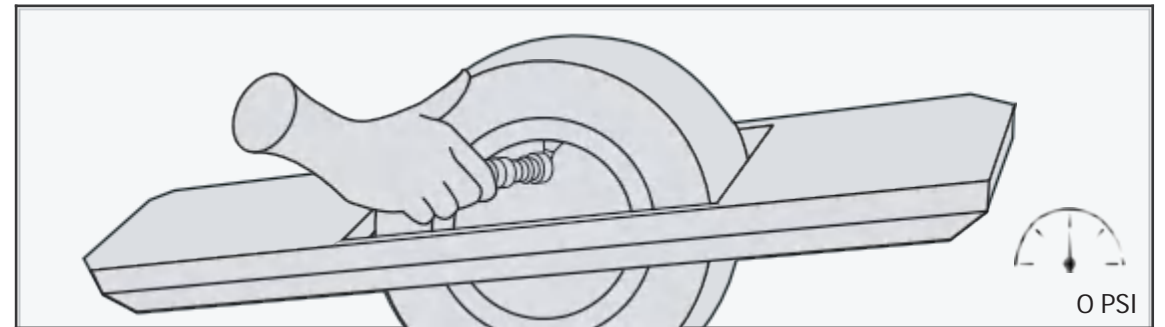

## BATTERY

Be careful not to overcharge or undercharge your battery. The battery should be charged at least once every two months. Failure to do so may void your warranty. You must dispose lithium batteries according to local laws and regulations.



**Warning:** If the battery pack appears to be damaged or is not holding a charge, plz do not use it. Further assistance, contact Gosmilo customer service or email to [service@smilomotors.com](mailto:service@smilomotors.com)



**Cautions:** Do not expose the battery to extreme high or low temperatures. These may degrade or damage the battery pack.

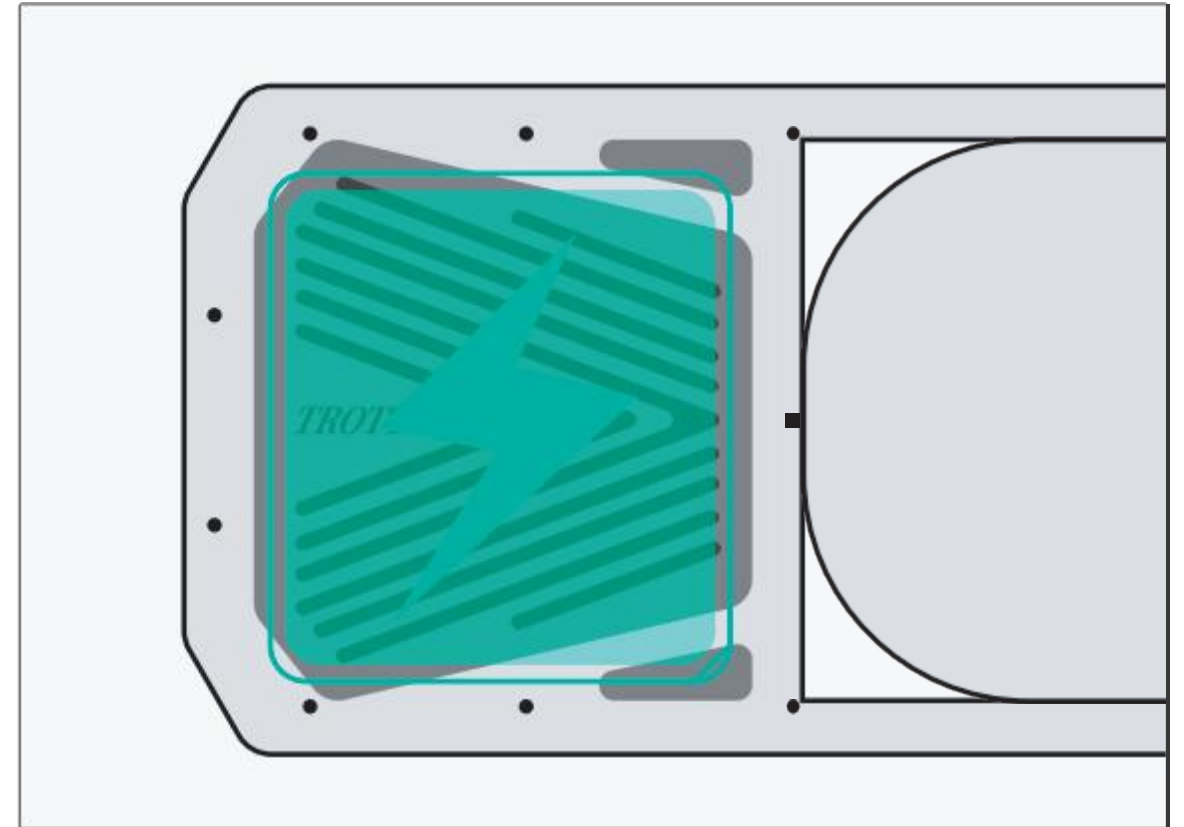

## Gosmilo BOARD CARE

---

### DAILY USE

Keep it dry, keep it clean, and keep it charged. Easy to keep. When you are done riding store your board in warm, dry place. Don't leave it outside or in your car overnight .

### WET ENVIRONMENTS

Make sure you completely wipe your board off after riding in any wet environments. Get all debris off and let it fully dry out before charging . The board is water - resistant not waterproof . Ride into wet environments at your own risk.

### COLD WEATHER

Gosmilo can be operated in the cold. Don't let the winter cold ruin your fun . Don't leave your board outside or in the trunk of your car . Long exposure to extremely cold temperature can adversely affect your board . If you do happen to leave your board out in the cold, you may have to bring it and warm it up. It may take an hour or more to warm up to rideable temperature .

### LONG TERM STORAGE

Make sure to charge between 40-50% and store it in dry place between 50-60°F (10-15°C)

Check it monthly to ensure your battery remains between 40-50%

## WARRANTY

---

This agreement outlines the limited warranty coverage supplied by Gosmilo, which is defined as an individual who has purchased the Gosmilo in a retail establishment or via an online storefront as approved by the Gosmilo or from a Gosmilo-authorized sales representative. purchasing any products from an unauthorized reseller, including any online purchase other than directly from the Gosmilo, will void all product warranties to the extent permitted by law.

The Gosmilo warrants that the product, other than the footpad, tire and battery pack, will be free from defects in materials and workmanship for a period of 12 months/2000 KM whichever comes first. The warranty for the footpad/tire/led light is 3 months and battery pack is 6 months/1000 KM

If the Gosmilo proves defective and a claim is filed during the warranty period, the Gosmilo, at its option, will:

01 Repair the Gosmilo by means of telephone support, email support, or by providing service at no charge for parts or labor.

02 Replace the Gosmilo with a comparable one which may be new or refurbished.

03 Refund the original amount paid for the Gosmilo less a reasonable allowance for usage, upon its return.

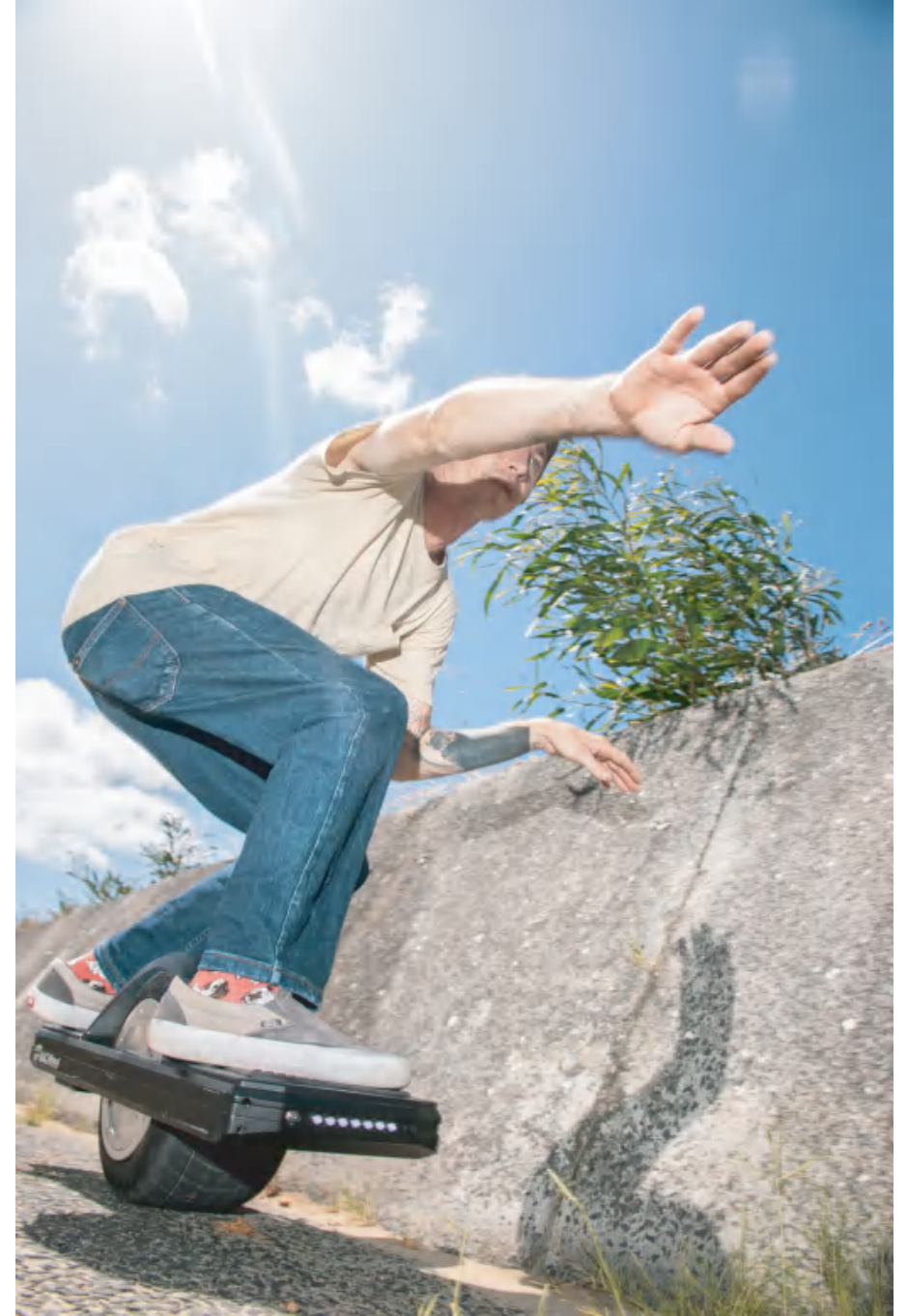

The Gosmilo recommends that the user first utilize support materials shipped with the Gosmilo. Gosmilo diagnostics, information contained on the Internet, and email support. If unsuccessful, to obtain service under this warranty the user must notify the Gosmilo or its authorized service.

Gosmilo provides paid repairs for products that are out of warranty. All sales are final.

If you wish to discard this product please contact your local authorities or dealer and ask for the correct method of disposal.

## COMPONENT WARRANTY DURATION NOTES

(For defects in materials and workmanship)

COMPONENTS	WARRANTY DURATION	notes
BOARD	1 year	Parts that not listed separately
FOOTPADS/TIRE/led light	3 months	



## WARRANTY

---

### THE FOLLOWING ARE NOT COVERED BY THE WARRANTY:

Total mileage is over 2000km.

Damage has been caused by modification or use outside those specified in the User Manual.

The barcode or serial number of the product has been altered or removed. The warranty registration is inconsistent with the product itself.

The product has been dismantled or repaired by an unauthorized third party.

Water damage is not covered under warranty.

Damage or fault has been caused by other issues [excluding product design, manufacture, quality, etc.].

Natural wear and tear that does not affect product function (including scratches and wear and tear on frame rails, footpad, tires, etc.).

Damage has been caused by accidents or human errors, such as breakage caused by dropping or rusting in a very wet environment.

Damage has been caused by overloading the Gosmilo.

Damage has been caused by acts-of-god such as fire, flood, earthquake, freezing, etc. Products purchased from an unauthorized reseller, including any online purchase other than directly from Gosmilo to the extent permitted by law.

All the above warranty policies are valid only within the warranty period specified above

### CONTACT US

Guzhuang, Benniu Town, Xinbei District, Changzhou City, Jiangsu Province, China

info@smilomotors.com

Manufacturer: CHANGZHOU SMILO MOTORS CO., TLD

All rights reserved: CHANGZHOU SMILO MOTORS CO., TLD

All rights reserved, pirates must investigate.

All sales are final.



Let's join the game

Riding with exceptional ability, style, speed and enthusiasm