

Gofort

Portable Solar Power Station

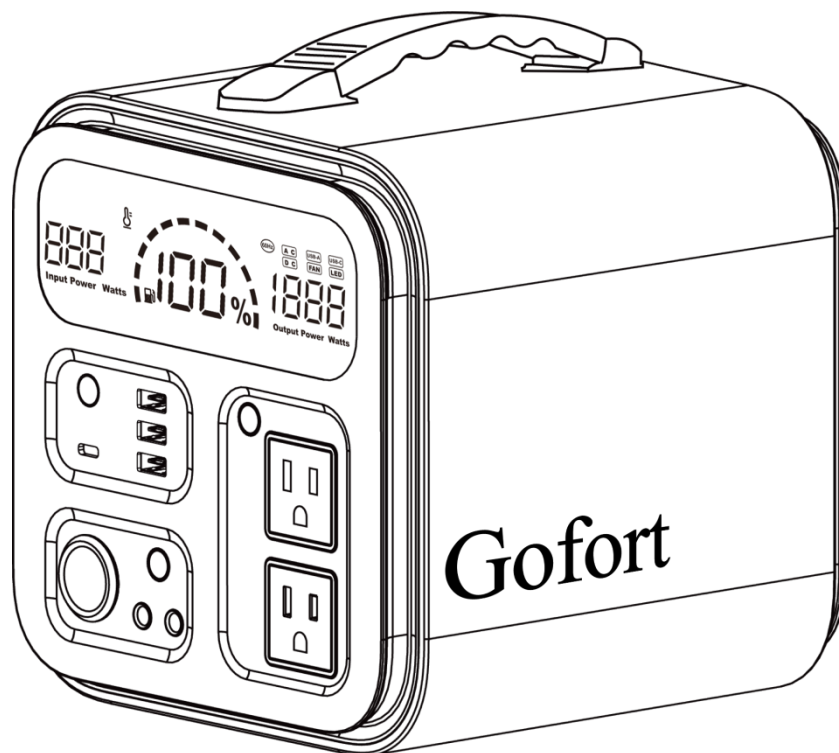

User Manual

ATTENTION

The specifications and the pictures in this manual are for reference only. The product is only used for emergency situations, it cannot replace the standard AC power for household appliances or digital products .Actual AC outlet and AC adapter would be different depending on the locations of customer.

Thank you for choosing UA550 Portable Power Station.

The purpose of this manual is to help you use the product correctly.

Please read the manual carefully and follow the guidance.

Product Specifications

<i>Model</i>	<i>UA550</i>
<i>Battery</i>	<i>Lithium-ion Battery, 550Wh,148800mAh(3.7V)</i>
<i>AC Output</i>	<i>AC Pure Sine Wave Output</i>
<i>AC Continuous Power Output</i>	<i>600W</i>
<i>AC Peak Power Output</i>	<i>1000W</i>
<i>Standard Out Voltage</i>	<i>110V</i>
<i>Input (Adapter)</i>	<i>12V-24V</i>
<i>Input (Solar Panel)</i>	<i>18V-24V ($\geq 100W$ recommended)</i>
<i>Input(Car)</i>	<i>12v cigarette lighter</i>
<i>USB Output</i>	<i>1 X USB Output QC3.0 2 X USB Output 5V/2.4A</i>
<i>PD Type-c Output</i>	<i>45W</i>
<i>DC Output</i>	<i>12/10A(Max)</i>

<i>LED</i>	<i>5W /450lm</i>
<i>Charging Time</i>	<i>Approx 6 hours (with 22V/5A adapter)</i>
<i>Operation Temperature</i>	<i>-10°C ~40°C</i>
<i>Life cycle</i>	<i>> 800 times</i>
<i>Dimensions(LWH)</i>	<i>192*218*192MM</i>
<i>Net Weight</i>	<i>About: 6.8kg</i>
<i>Gross Weight</i>	<i>About: 8.8kg</i>

Product Overview

Front and back overview

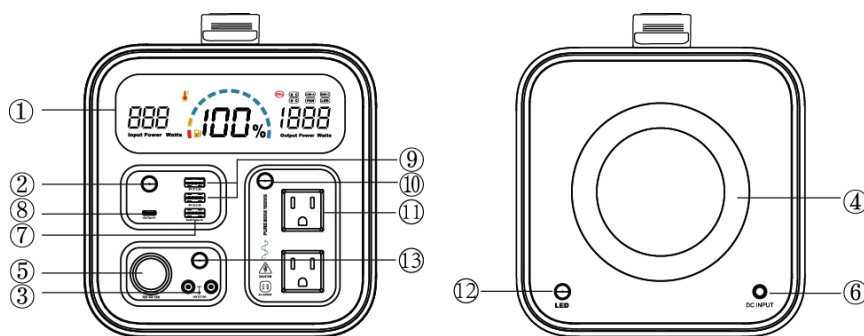

1.	<i>Display Screen</i>	2.	<i>USB Switch</i>
3.	<i>double DC5521 12V/10A Output</i>	4.	<i>LED Light</i>
5.	<i>Cigarette Lighter Output</i>	6.	<i>DC Charging Input (Solar, Adapter & Car Charging)</i>
7.	<i>USB-A / QC3.0 fast charging Output</i>	8.	<i>USB-C/ PD3.0 45W Output</i>
9.	<i>Double USB-A / 5V 2.4A Output</i>	10.	<i>AC Switch</i>
11.	<i>Double AC Output</i>	12.	<i>LED Switch</i>
13.	<i>DC switch</i>		

※ **Note : DC5521 port is with outer diameter of 5.5mm, inner diameter of 2.1mm.**

Introduction To The Display Screen

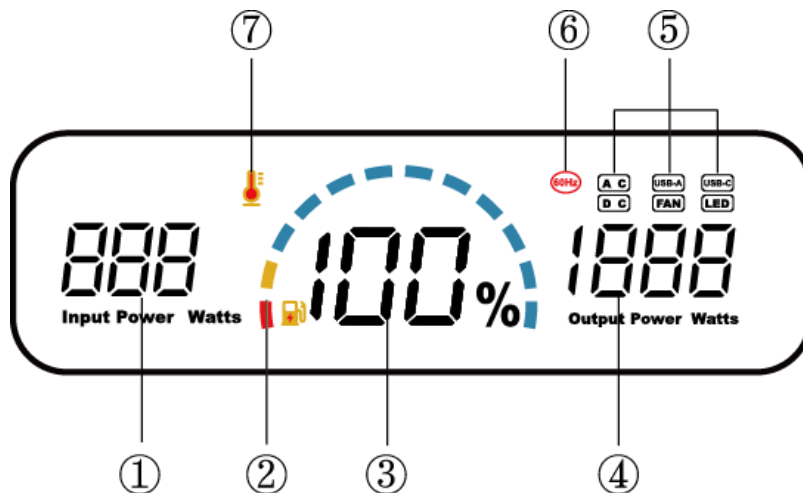

No.	Icon	Description
1	Input Power in Watts	The input power of UA550
2	Battery indicator Arc	Approx 9% capacity each grid, yellow grid reminds of input charging, red grid alarms capacity below 5% and requires charging urgently.
3	Battery percentage	Remaining battery percentage
4	Output power in watts	Total power of output load
5	Operating function modes indicator	Synchronize the operating function mode of fan, AC, DC, USB and LED.
6	Frequency Indicator	AC output frequency 60Hz
7	Thermometer icon	Overheat indicator, icon will light up when UA550 is overheated.

1 . Long press the USB switch button for 1.5 seconds to start USB function, USB-A and USB-C mode will show up on the screen; long press it for 1.5S again to shut the function. Long press it for over 3S to shut the whole generator.



2 . Long press DC switch button for 1.5 seconds to start DC function, DC mode will show up on the screen; long press it for 1.5S again to shut the function. Long press it for over 3S to shut the whole generator.



3 . Long press LED switch button for 1.5 seconds to light on the LED, letters LED will show up on the screen; long press it for 1.5S again to switch off the LED light.

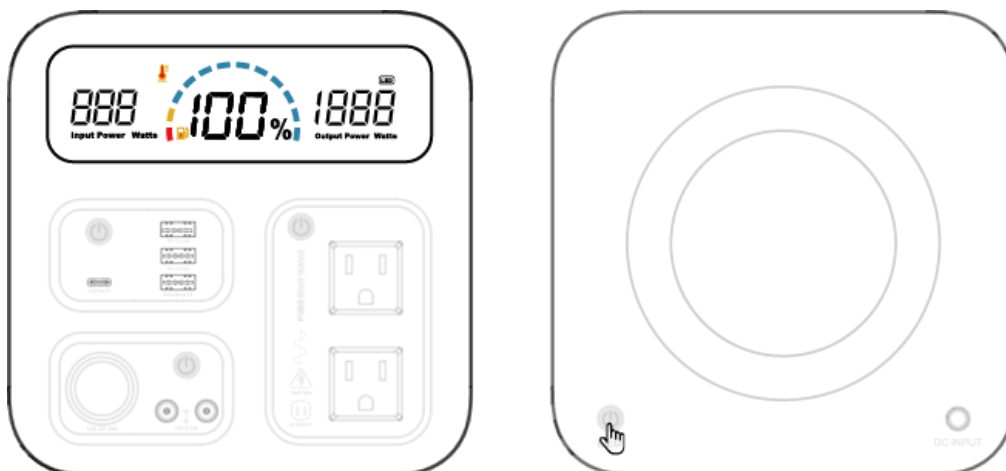

4 . Long press AC switch button for 1.5 seconds to start AC function, AC mode will show up on the screen; long press it for 1.5S again to shut the function. Long press it for over 3S to shut the whole generator.



5 .UA550 supports input and output charging simultaneously(UPS), the screen will show both charging status as well as various function modes. When charging and discharging at the same time, overheat temperature protection is based on the charging temperature.

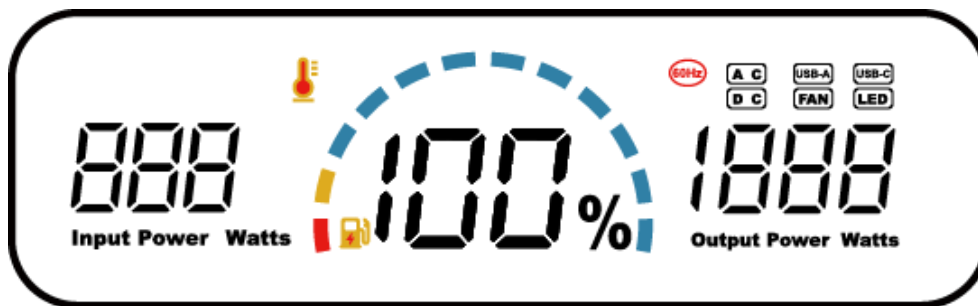

Warning: our UPS function only for short time usage, we don't recommend to use lithium battery UPS power as long time use as lead-acid battery UPS power, please do not input and output charging simultaneously for a long term usage

How to charge the product ?

1 . Charge through AC wall charger

Connect the power adapter which come with the product to any wall outlet . The

Battery Indicator Arc on the LCD screen blinks which indicates that the product is

NO.of Indicator light	1indicator (red) light blinks	2 indicator (yellow) light blinks	3 indicator light blinks	4 indicator light blinks	5 indicator light blinks	6indicator light blinks
Battery status	0%-5% charged	5%-14% charged	14%-23% charged	23%-32% charged	32%-41% charged	41%-50% charged
NO.of Indicator light	7 indicator light blinks	8indicator light blinks	9 indicator light blinks	10indicator light blinks	11indicato r light blinks	12indicato r light blinks
Battery status	50%-59% charged	59%-68% charged	68%-77% charged	77%-86% charged	86%-95% charged	95%-100% charged

being charged.

When fully charged, the Battery Indicator Arc will be fully lighted on and stop flashing, and the battery percentage shows 100%. After the product is fully charged , please unplug the AC wall charger in time .

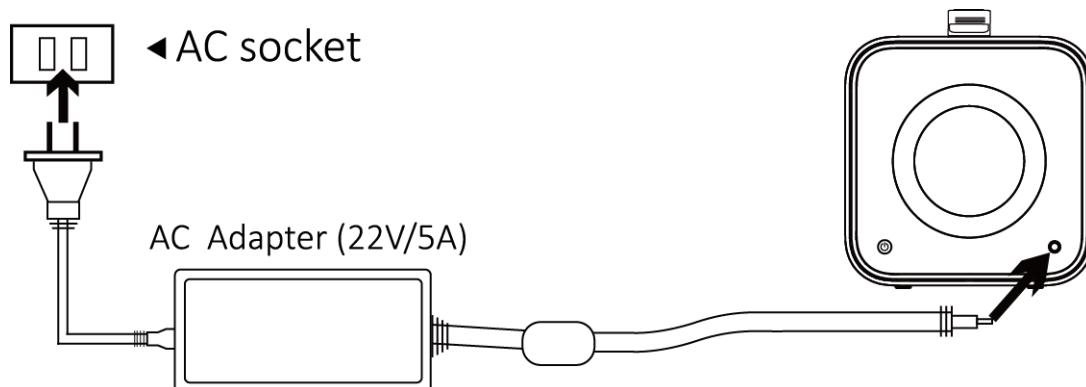

2 . Charge through solar panel (18V, \geq 100W recommended)

- 1. Place your solar panel where it will get as much strong direct sunlight as possible.*
- 2. Connect the output port of the solar panel with the input port of the product to start charging. When the Battery Indicator Arc on the LCD screen blinks, the product is being normally charged; when the Battery Indicator Arc is fully lighted on and stops flashing, and the battery percentage shows 100%, the product is being fully charged.*

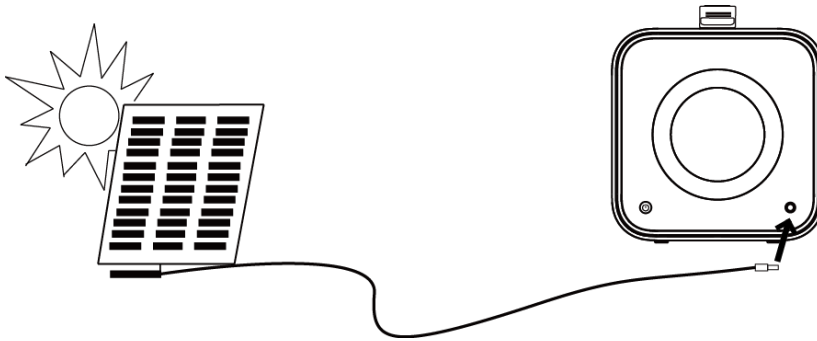

※Note : When the sunlight is not strong enough to support continuous input charging, please press the USB power switch to trigger the system.

※Note : Actual charging efficiency can vary widely depending on weather , temperature , battery state of charge , and other factors.

3. Charge through the cigarette lighter receptacle of your 12V -15V car

Using the car charger, plug the product into the 12V -15V cigarette lighter receptacle of your car. When the battery indicator arc on the LCD screen is flashing, you will know the product is charging . When the battery indicator arc on the screen is fully lighted on and stops flashing, with battery percentage shows 100%, the product is fully charge .

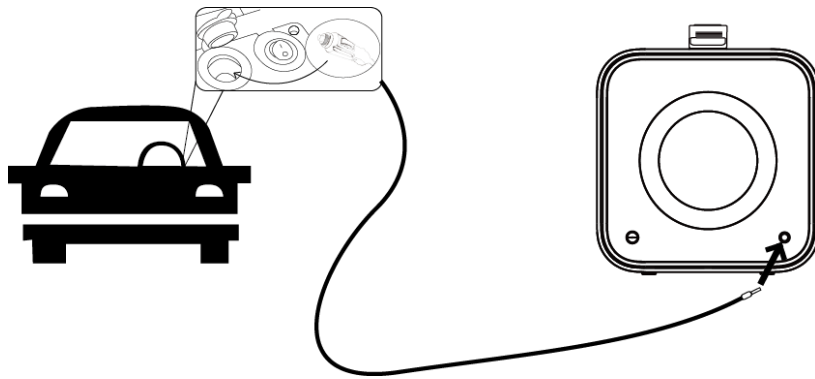

Attention : To avoid car battery power loss , you should charge this product through your car cigarette lighter only when your car engine is started . This function is for 12V-15V car .

Operation Guide

1. How to charge your facilities with the DC output of UA550 ?

Connect your DC 12V appliances with the 12V DC output port. And your appliances would be charged automatically.

✘ **Note :** Please check to make sure that your 12V DC appliance supports charging with the DC port of this product , which is DC 5521 port. You could confirm it with the manufacturer or seller of your 12V DC appliances.

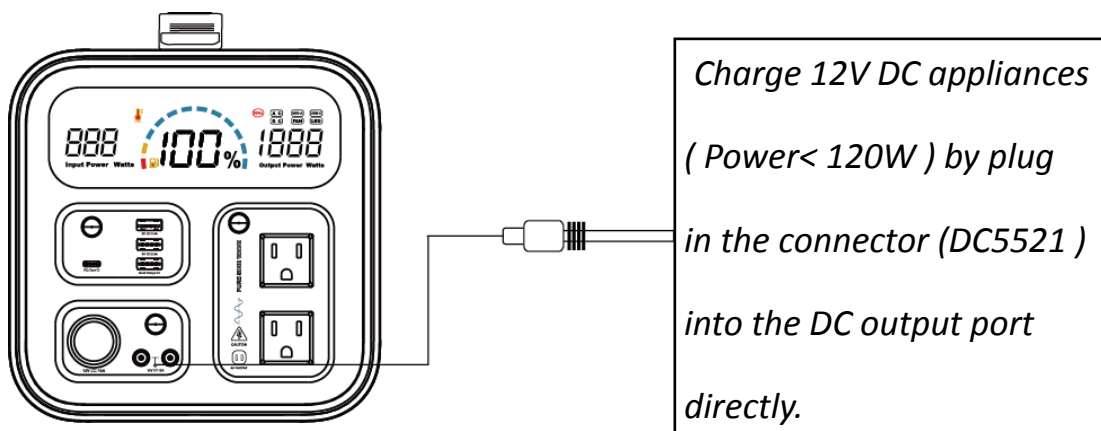

⚡**Note** : The DC output of this power station is approx constant 12.8V. The max output current is 10A . Please make sure your appliance can match this voltage.

Protection Mode (DC Output):

Short-circuit / Over power Protection : If the DC output is short-circuited or overpowered (Load (S) power > 120W) , the product will shutdown to protect itself . Please disconnect the 12V appliances from the product and repress to start the product .

2. How to charge with the AC outlet of this product ?

Connect the power cable plug of the AC electrical appliance to the AC outlet of the product . Press the AC power switch and the product will start providing power to your appliances . Please make sure that the power of the AC appliance is less than 600W.

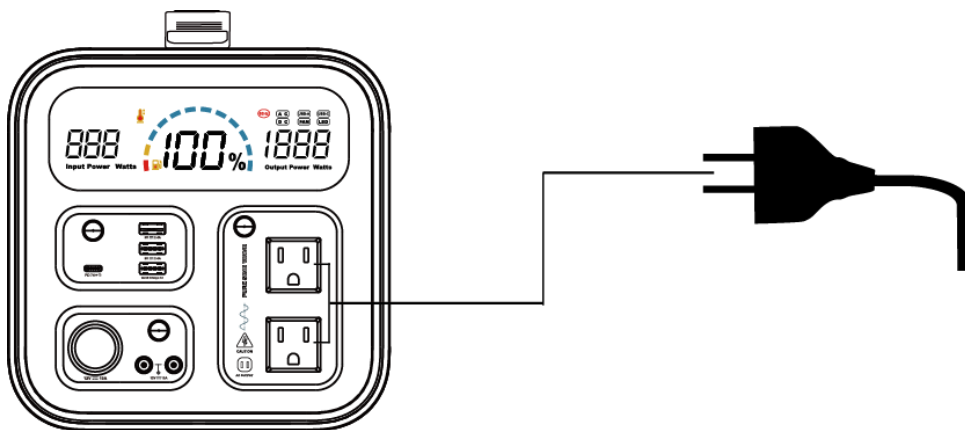

⚡**Note** : When the AC port is not in use , turn off the AC power button to conserve power.

Protection Mode (AC Output) :

Short-circuit / Overpower Protection : If the AC output is short-circuited or overpowered (load (s) power > 600W) , the product Will shutdown AC output to protect itself . Please disconnect your appliance and repress the button to restart the generator. Some electronic devices , such as refrigerator, ice maker or a laser printer may require a surge power to start or work . The surge power could exceed 700 W , which could cause overpower protection . Please disconnect the devices and consult with the device manufacturers for more information .

3. How to charge with the USB ports of this product ?

Connect the standard USB cable of your digital devices to the USB output ports of the product . Press the USB POWER button the product will start providing power . If the USB port fail to supply power to the digital device, connect your device to the AC power output by adding a mobile charger. Please switch off the AC power output to save power when your digital devices are fully charged.

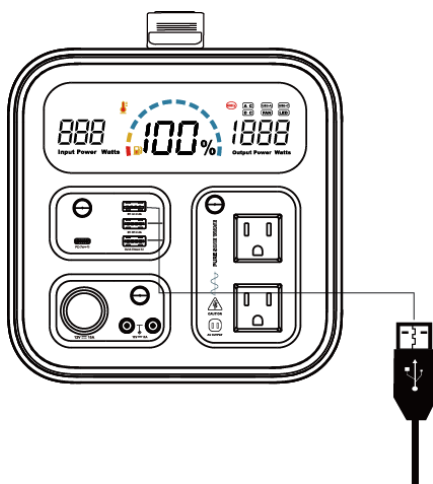

Smart phone,tablet ,etc.

Multifunction LCD Screen

The LCD display provides easy access to detailed generator settings and information . The LCD shows a variety of helpful data , including battery charge and discharge power watts, DC output and AC output status.

Cautions

- 1 . Do not short-circuit the product. To avoid short-circuiting , keep the product away from all metal objects (e.g. coins , hair-pins , keys , etc .)*
- 2 . Do not heat the product , or dispose it in fire , water or other liquids. Keep it away from high ambient temperature . Do not expose the product to direct sunlight.*
- 3 . Keep the product away from humid , dusty places.*
- 4 . Do not disassemble or reassemble this product.*
- 5 . Do not drop , place heavy objects on , or allow strong impact to this product.*
- 6 . This product is not intended to be used by persons with reduced physical , sensory or mental capabilities.*
- 7 . Please keep this product away from children.*
- 8 . Do not cover the product with towels , clothing and other item.*
- 9 . Do not over-charge this product.*
- 10 . When fully charged , disconnect the product from the power source immediately.*
- 11 . Please double check the total power of your await for charging devices before use this product . Make sure not exceed the rated power of this power station.*

Product Application Tips

- 1. It is recommended to use this product when the ambient temperature falls within-10 °C-40 °C , so as to obtain the optimal charging capacity.*
- 2. When charging this product , please keep it away from TV , radio and other equipment to avoid radio wave interference.*
- 3 . If you are not going to use this product for a long time , please disconnect the cable before storing it away.*

4 . *To charge some portable electronic devices , you may need to set those devices in charge mode first . Refer the corresponding user manual of those devices for confirmation.*

5 . *In order to extend the life of product (lithium battery) , it is best to charge it once every 3 months , or at least charge it once every 6 months.*

Cold Weather Usage

Cold temperatures (below freezing) can affect the products battery capacity due to chemical characteristics of the battery . If you ll be living off grid in sub-zero conditions , it is recommended to keep your product in an insulated cooler , and connected to a power source (solar panels) . The natural heat generated by the product contained in an insulated cooler will keep battery capacity at its highest.

Disposal and Recycle

This product should not be disposed along with household waste . Please dispose or recycle this product and the battery inside according to the local rules and regulations.

Battery Information

This product has an internal , non-removable , rechargeable battery . Do not attempt to remove the battery , as this may cause serious injury to you or damage to the device.

Pure Sine Wave Output

This product generates pure sine wave , which is compatible with AC electric appliance that works with Sinusoidal waveform (power < 600W). However , the product is only used for emergency situations . It cannot replace the standard DC or

AC power supply for household appliances or digital products . Electronic appliances that use an AC motor isn't going to work to its full capacity on a pure sine wave and noises may sound as a result. For long-term use, appliances like refrigerators , microwaves , and compressors that use AC motors and some delicate medical equipment will be better off with the standard DC or AC power supply.

Support MPPT Technology

Built-in MPPT(Maximum PowerPoint Tracking), the unit can compare the output of the solar panels to the battery voltage. It then figures out what is the best power that the panel can put out to charge the battery, and help the unit get maximum AMPS from the solar panels.

◆*Actual gain can vary widely depending weather, temperature, battery state of Charge, and other factors.*

Package Contents

1 X Portable Solar Generator

1 x Power Adapter

1 x Car Charger Cable

1 x User Manual

Warranty

Our company provides customers with warranty of 12 months from the date of purchase.



Gofort Team

Email: info@gofortpower.com

Website: www.gofortpower.com (more contact info could be found on our website)

**For more promotions, discount, coupons, activities or technical support,
after-sales, please feel free to contact us.**



MADE IN CHINA

