

## CONTACT US

### Email:

support@xmarto.com

### Website:

24/7 Product Support

FAQs

How-to Videos

Manuals

[www.xmarto.com](http://www.xmarto.com)

iPhone, iPad, Mac and Mac OS X are registered trademarks of Apple Inc. Windows, Windows XP, Windows Vista, Windows 7, Windows 8 and Windows 10 are registered trademarks of Microsoft Corporation in the United States and/or other countries.

### FCC RADIATION NORM

#### FCC

This device complies with Part 15 of the FCC Rules. Operation is subject to the following two conditions: (1) this device may not cause harmful interference, and (2) this device must accept any interference received, including interference that may cause undesired operation.

### FCC Compliance Statement

These limits are designed to provide reasonable protection against frequency interference in residential installation. This equipment generates, uses, and can radiate radio frequency energy, and if not installed or used in accordance with the instructions, may cause harmful interference to radio communication. However, there is no guarantee that interference will not occur in television reception, which can be determined by turning the equipment off and on. The user is encouraged to try and correct the interference by one or more of the following measures:

- Reorient or relocate the receiving antenna.
- Increase the separation between the equipment and the receiver.
- Connect the equipment into an outlet on a circuit different from that to which the receiver is connected.
- Consult the dealer or an experienced radio/TV technician for help.

### CAUTION!

The Federal Communications Commission warns the user that changes or modifications to the unit not expressly approved by the party responsible for compliance could void the user's authority to operate the equipment.

This equipment should be installed and operated with a minimum distance of 8 inches between the radiator and your body.

# Wire-Free Security System

## QUICK SETUP GUIDE



# Content

1. What's in the Box .....	1
2. Before You Start .....	2
3. Working Diagram .....	3
4. Product Overview .....	4
5. Connecting Your System .....	6
6. Positioning Your NVR and Cameras .....	9
7. Mounting the Camera and Solar Panel .....	11
8. Booting Up for the First Time .....	14
9. Using the WallPixel Mobile App .....	17
10. Safety Instructions of Battery Usage .....	22
11. Pairing an Add-on Camera .....	23
12. Switch Cameras to 24/7 Working Mode .....	25
13. Frequently Asked Questions .....	27

# 1. What's in the Box

**DISCLAIMER:** The exact components of your system, images and quantities may vary depending on your model number. While these may vary, this QSG will address the setup and initial configuration of your NVR and cameras.

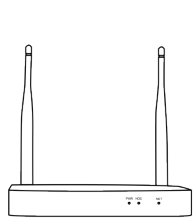

NVR or Monitor Built-in NVR (x1)

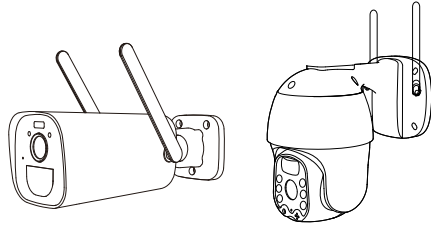
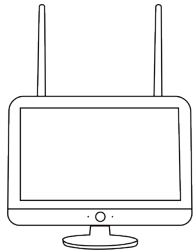

Bullet or Dome Wire-Free Camera(s)

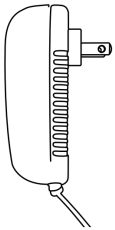

NVR Power Adapter (x1)

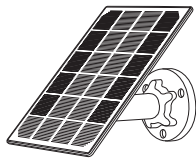

Solar Panel (1 per camera)

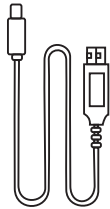

Camera Charging Cable (1 per 2 cameras)



HDMI Cable (x1)

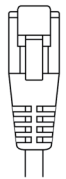

RJ-45 Ethernet Cable (x1)

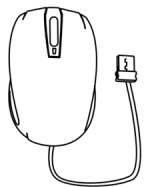

USB Mouse (x1)



Mounting Hardware (x1)

**NOTE:** For best results, use the included accessories. Third party accessories may not work properly.

# 2. Before You Start

Before setup of the camera, we strongly recommend to recharge the camera overnight to make sure it has 100% power.

1. To charge your cameras, use 5V DC phone chargers (not included) and cables (included) to charge the cameras.

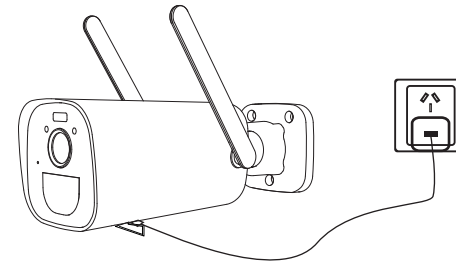

2. The indicator blinks in green while charging; indicator turns off when it's fully charged.

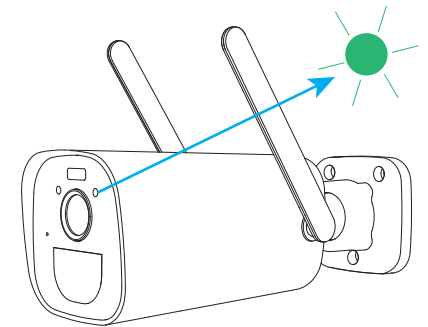

**NOTE:**

- Please use only 5V DC power charger to recharge the camera. Chargers do not meet the standard may damage the batteries.
- Please charge the battery at room temperature to avoid damage.

### 3. Working Diagram

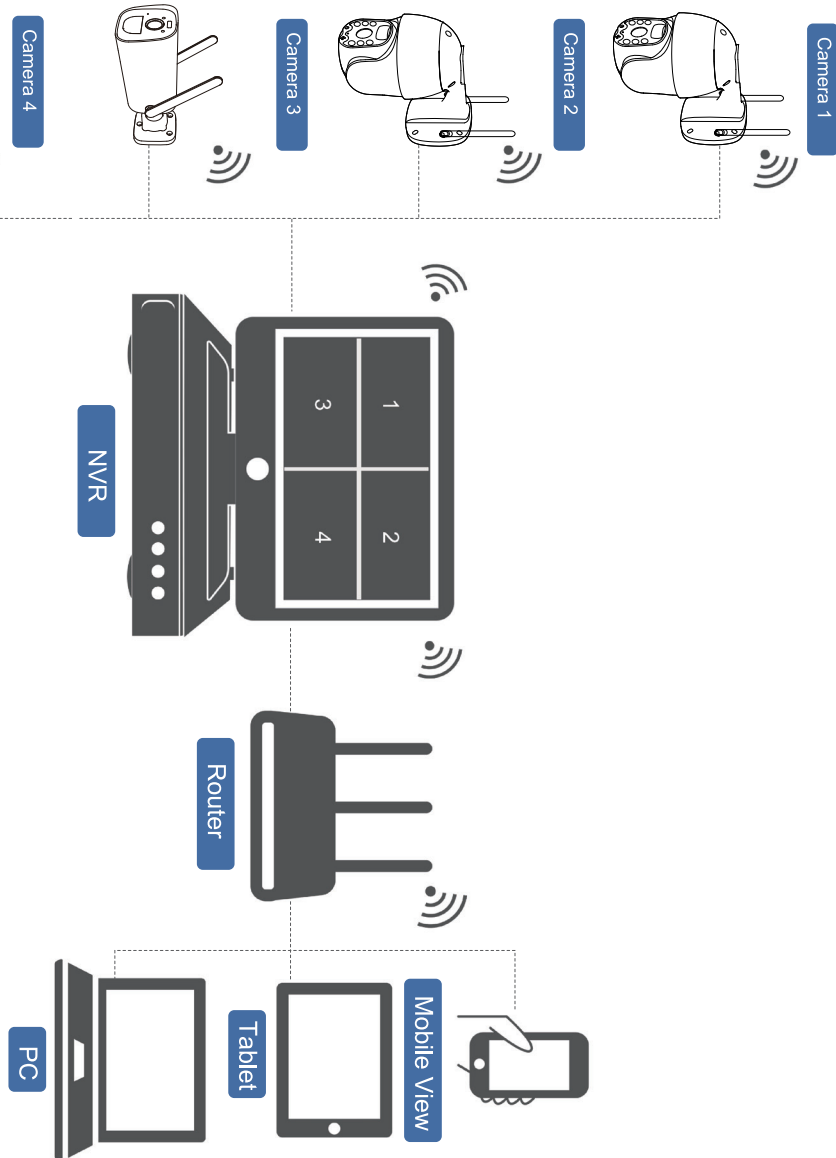

### 4. Product Overview

#### The Mini NVR:

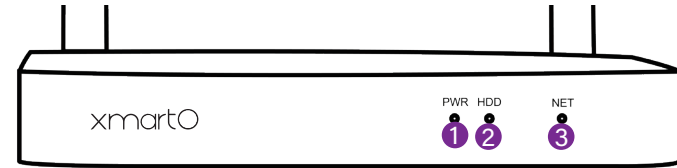

- ① **Power indicator** - Indicates whether the NVR is powered on.
- ② **HDD indicator** - Indicates whether the hard drive is running.
- ③ **Network indicator** - Indicates the network status.

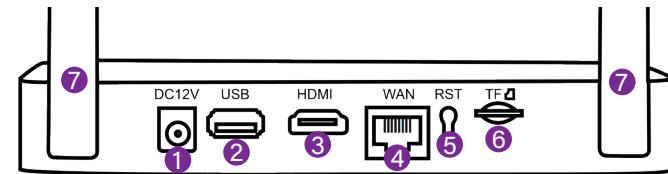

**NOTE:** The maximum number of cameras you can connect to your NVR will be determined by the number of channels.

- ① **Power Input** - Used to connect the included 12V DC power supply.
- ② **USB Port** - Allow for the connection of a USB mouse or a USB flash drive. Connect the included USB mouse to assist in navigating the NVR's menu interface. Connect a USB flash drive to download video files from the NVR for long term storage or sharing.
- ③ **HDMI Output** - Allows for a video connection. If the TV/Monitor has an HDMI input, connect the HDMI cable from the HDMI output port on the NVR to the HDMI input port on your TV/-Monitor.

- ④ **RJ-45 (Ethernet) Port** - Used to connect the NVR to your modem/router for remote viewing. You can also connect your NVR to the Internet via Wi-Fi.
- ⑤ **Reset** - Used to hard reset your NVR to manufacturer settings.
- ⑥ **Micro SD Card Slot** - Allows for video storage. You can also add a 2.5" HDD to the NVR for mass storage.
- ⑦ **NVR Antennas** - For Wi-Fi connection with all cameras.

### The Cameras

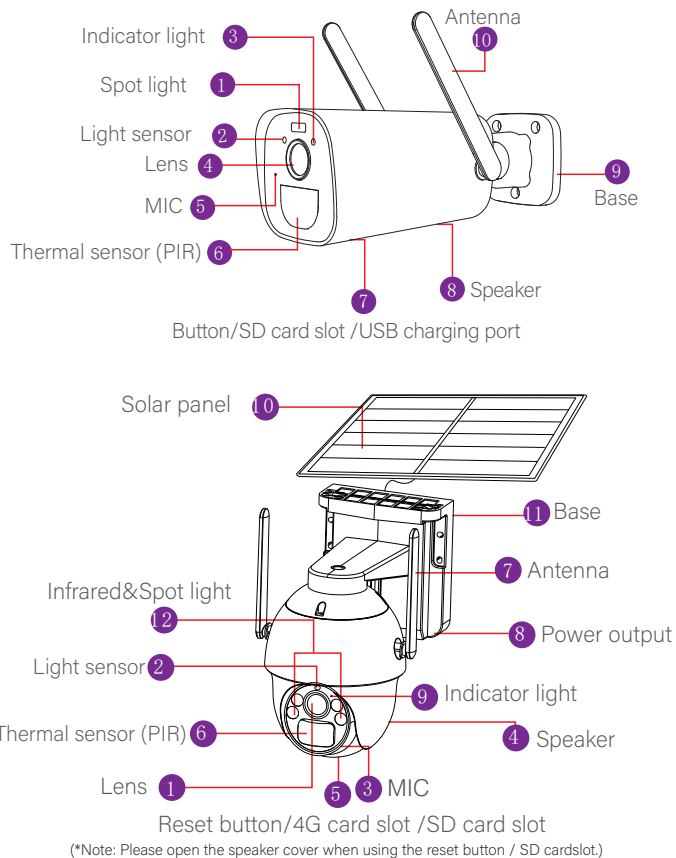

### NOTE:

- Different types of cameras are included in this section. Please check out the camera included in the package and check out the details from the corresponding introduction above.
- The actual appearance and components may vary with different model of product.

## 5. Connecting Your System

**STOP** Connect all cameras locally before final placement to ensure that all components function properly.

1. Connect the NVR to a PC monitor or TV with included HDMI cable.

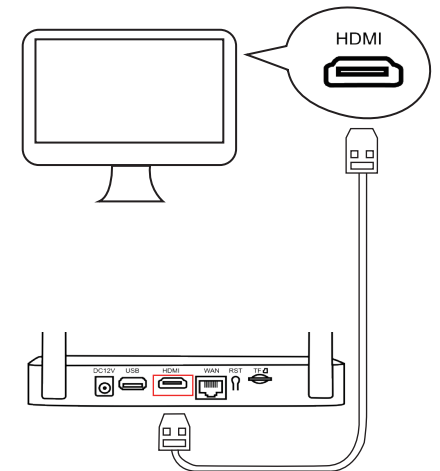

**NOTE:** Monitor is required for initial setup. After completing the initial setup, your NVR does not need to be connected to a TV or monitor to view or capture recordings.

2. Connect the NVR WAN port to your router with included Ethernet cable. (Skip this step if you plan to connect the NVR to Internet via Wi-Fi)

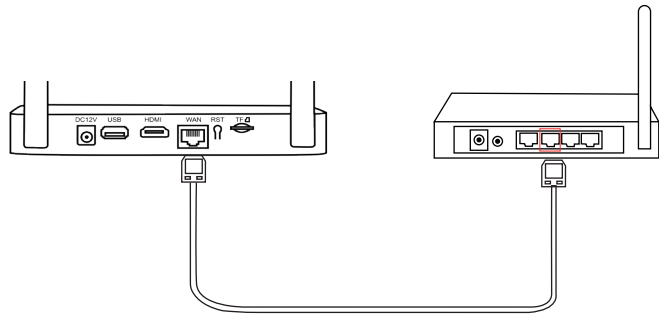

3. Plug the USB mouse into the USB port on the NVR.

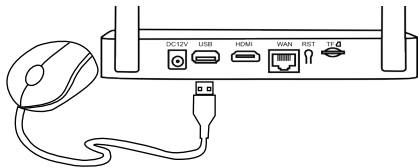

4. Connect the NVR to power with included power adapter.

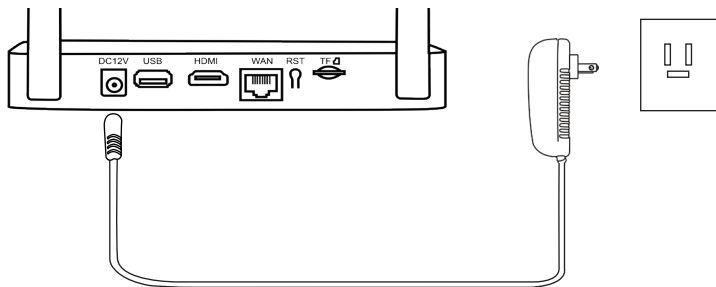

5. To verify whether cameras are working, please ensure they appear on your TV/ monitor before mounting them.

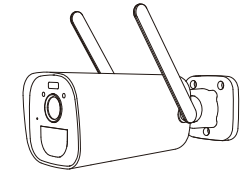
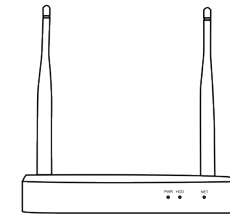

**NOTE:** Make sure NVR is in intended location before testing cameras.

6. Hold the ON/ OFF switch of the camera to turn it on.

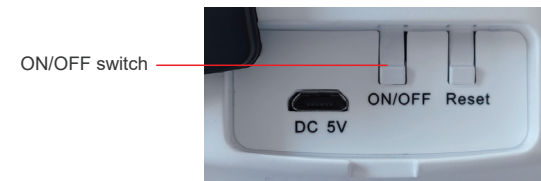

**NOTE:** you should see each camera appear on your TV/ monitor. You may now proceed to install cameras in the desired locations.

7. Bring cameras to desired mounting locations and go back to NVR screen, click play to see if they can stream fluently. If a camera does not stream well, adjust it to a location with less obstacles in-line-of-sight from the NVR. If they stream fluently, go ahead to mount the cameras.

**NOTE:** select a least interfered Wi-Fi channel so your NVR performs its best Wi-Fi capability. In NVR's menu – System setting – Network – NVR Wi-Fi hotspot, click "Adaptive Channel"

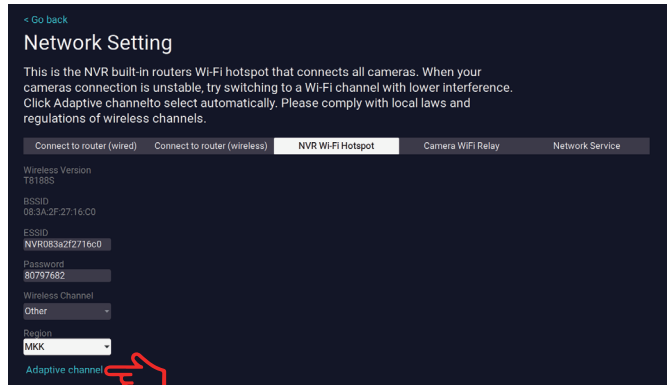

For bigger NVR, in NVR's menu - System setting - Network Setting - WiFi setting, click "Auto select WiFi channel".

## 6. Positioning Your NVR and Cameras

- Camera distance from NVR can reach up to 300 ft. wirelessly. Therefore, proper placement of the wireless NVR in your home will help ensure you achieve maximum coverage.
- Do NOT place near high voltage wires or other sources of electrical interference. Electrical interference will degrade the quality of the signal.

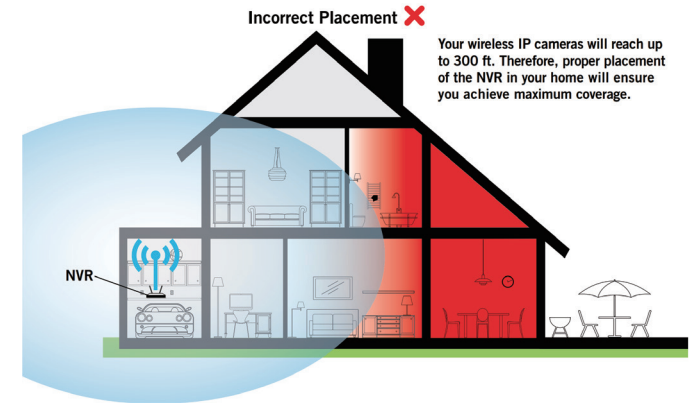

Your wireless IP cameras will reach up to 300 ft. Therefore, proper placement of the NVR in your home will ensure you achieve maximum coverage.

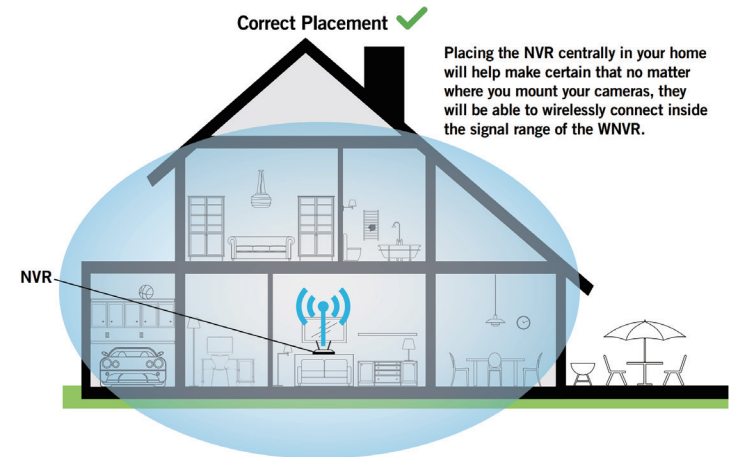

Placing the NVR centrally in your home will help make certain that no matter where you mount your cameras, they will be able to wirelessly connect inside the signal range of the WNVR.

- Install the camera 2-3 meters (7-10 ft) above the ground. This height maximizes the detection range of the motion sensor.
- For dome cameras, they MUST be installed upside down for better waterproof performance and better motion sensor's efficiency.
- For better motion detection performance, please install the camera angularly.

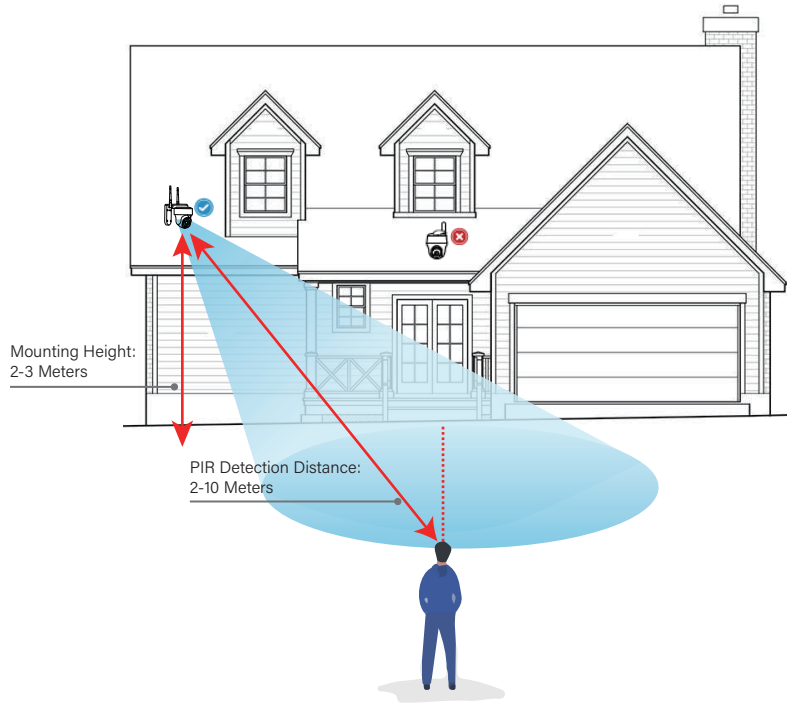

## 7. Mounting the Camera and Solar Panel

### Mount the Camera

1. Unscrew the bracket from the camera. Use a pencil to mark screw holes on the wall.
2. Fix the bracket on the wall with 3 screws.



3. Attach the camera to bracket and adjust the view angle.

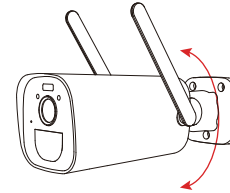

4. If you use a solar panel, mount the solar panel and plug to the camera. Adjust the panel so it captures good sunlight.

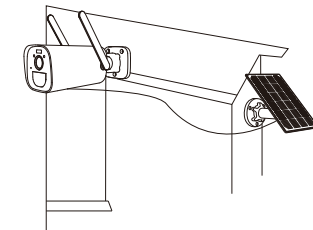

PIR sensor is sensitive to heat changes, please note:

- Avoid installing the camera where has complicated air flows. For example: the air vent of an air conditioner, the side of a fan etc.
- Please do not install the camera against glass or a mirror.
- While installing, avoid lining up the camera with a path. Keeping some angle will help the camera to sense people.
- Do not install the camera upside down. (PIR sensor is the downside.)

### Mount the Solar Panel

Connect your solar powered camera to this solar panel with 3m connection cable (included) to get non-stop power.

1. Please select a position with the maximum sunlight exposure throughout the year for your solar panel. Mount your solar panel facing due south (in the northern hemisphere) or due north (in the southern hemisphere) and tilt it to the appropriate angle for your latitude.

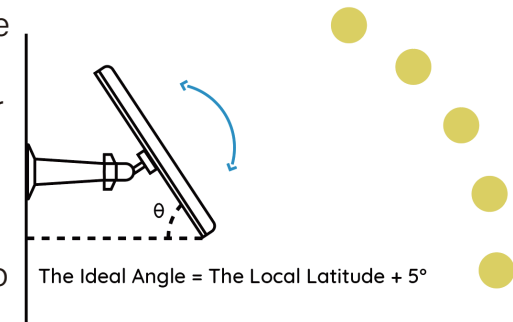



2. Mount the bracket with the screws provided in the package.

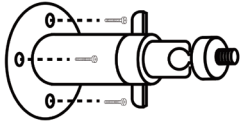

3. Slot the solar panel into the bracket and make sure that it's secure.

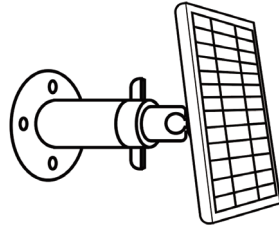

4. Loosen the adjusting control on the bracket and adjust the angle of the solar panel to make it receive direct sunlight exposure, then tighten the adjusting control to fix the solar panel.

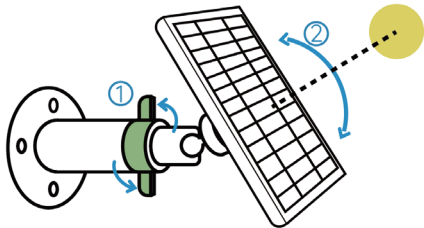

5. Connect the solar panel to the camera with included USB cable.

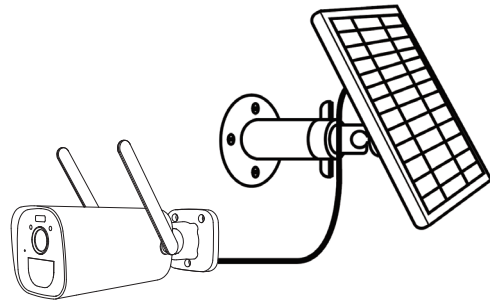

**NOTE:**

1. Make sure that there is NO blocking on the solar panel. The energy harvesting efficiency drops drastically even when a small portion of the solar panel is shaded by other objects.

2. Please don't install the solar panel completely horizontally. Otherwise, your solar panel might accumulate dust and other debris easily. It's advised to install the solar panel angularly to make it receive direct sunlight exposure.

3. Wipe the solar panel regularly to remove the dust and debris.

4. Make sure that the camera is plugged in all the way and that the waterproof wire cover protects the interface between the camera and the solar panel.

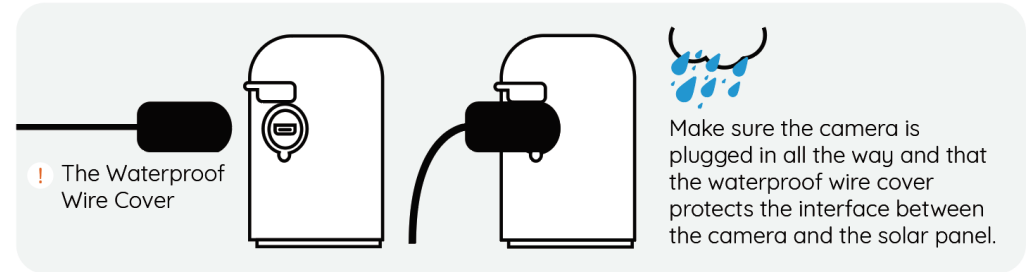

## 8. Booting Up for the First Time

### • Startup Wizard

1. When you power on the NVR you will be prompted the Startup Wizard. Please follow the on-screen steps to complete the Startup Wizard.



2. The Network Setting screen of the Startup Wizard displays instructions on how to connect your NVR to the Internet. You can either hardwire the NVR to your router for Internet access, or connect the NVR to your Wi-Fi (Wireless network setting)

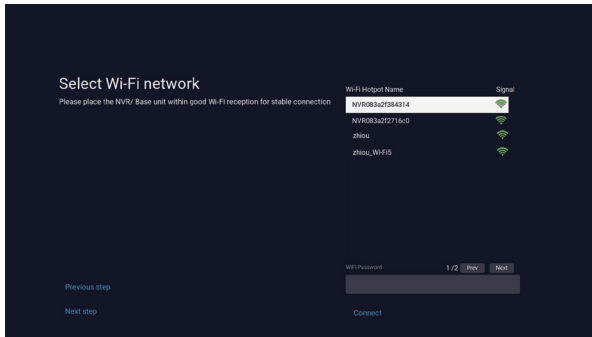
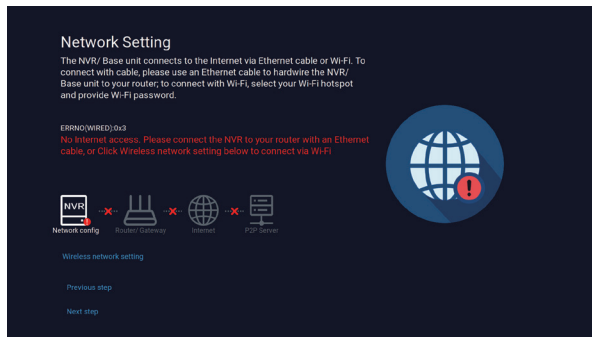

3. The Set Password screen of the Startup Wizard requires you to create an admin password for your NVR.

### • Admin Account Creation

By default, the username will be **admin**. It must remain **admin** upon your initial account configuration. However, you may add additional users at a later time.

**NOTE:** Password can be any alphanumeric combination between 6 and 20 characters.

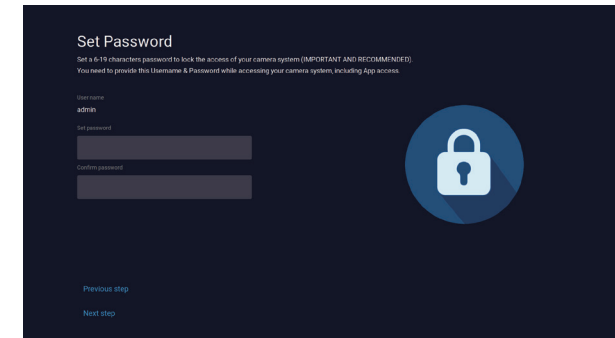

### • Remember Your Password

We strongly recommend writing down your password within the Quick Setup Guide. You will need it every time you log into your NVR and to remotely view on Smart Device.

Write your password here:

4. This is the last screen you will see when you have successfully completed the Startup Wizard. Scan the QR code to install WallPixel App.

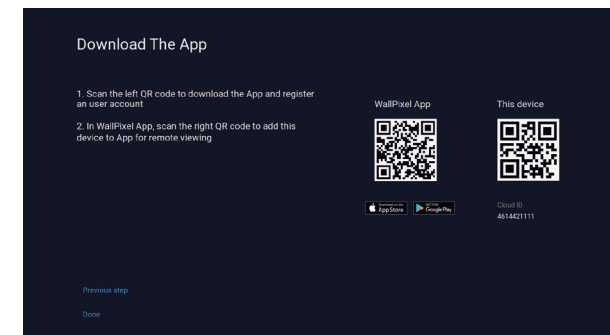

**NOTE:** For additional configuration of your NVR, please refer to the complete user manual located on our support page at [www.xmarto.com](http://www.xmarto.com).

## 9. Using the WallPixel Mobile App

### • Download and Install Application

1. Download the WallPixel app from the App Store or Google Play Store and install the application on your device.

**NOTE:** Setup is the same for Smartphone and Tablet.

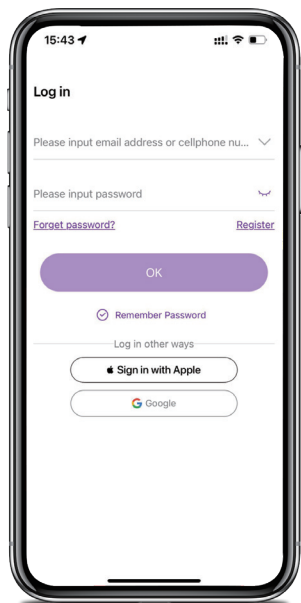

2. Create an account using an email address or phone number for the username and a password between 6–20 characters.

3. After completing the account setup, sign into the app and tap the "+" symbol to add a device. The WallPixel App will lead you through the rest of the setup process.

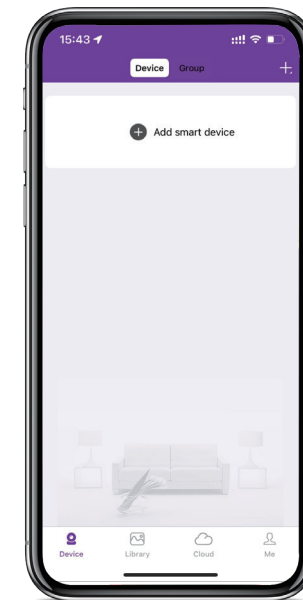

### • Connecting and Adding your Device

A device can be added to the WallPixel App by using the App's **Scan Local Network** or through a **QR Code Setup**. With Scan local network function, your NVR will automatically be detected by the WallPixel App, making it easy. To use this preferred method, ensure your smartphone and NVR are both in the same network.



## • Add a Device

4. To add the NVR system to App, please make sure you've connected your NVR to Internet. You can connect it to Internet in the setup wizard, or in Network Setting.

### 4A. Scan Local Network

If your NVR and smartphone are in the same network, tap Scan Local Network on the bottom, the App will find the NVR in the LAN, you can add it to App with a single tap.

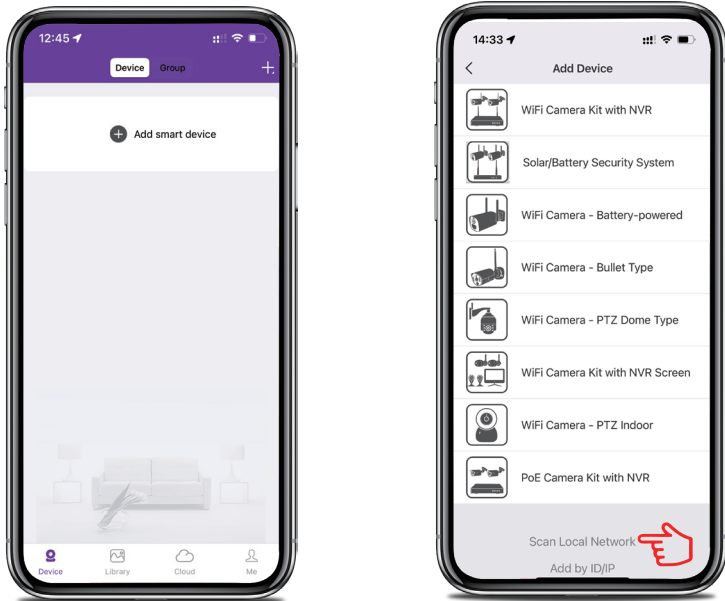

If this method is not available, please use the QR Code Setup from step 4B below.

### 4B. QR Code Setup

To use the QR Code Setup, click the plus + sign and **Scan**, then hover your smartphone camera lens over the QR code labeled on the NVR.



5. On the Add Device screen, enter the NVR login password. The NVR username is **admin** by default. If you are not the **admin**, login with your username credentials. (the password set in step 8.3)

**NOTE:** the NVR login and WallPixel App login are different.

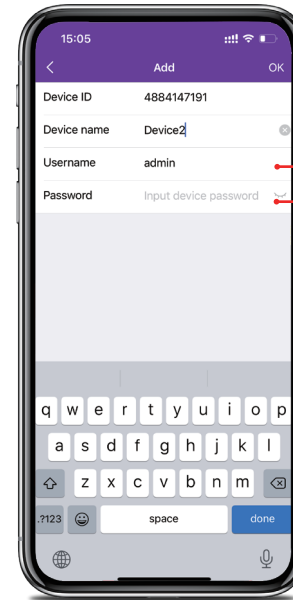

admin is case sensitive (all lowercase).

The password will be the same password you created during the Startup Wizard and should be stored in your QSG.

**NOTE:** This is the password of your NVR, NOT the password used to login to the WallPixel App. You must key the NVR password verbatim to add it to the app.

## 10. Safety Instructions of Battery Usage

The camera is not designed for running 24/7 at full capacity or around-the-clock live streaming. It's designed to record motion events and to live view remotely only when you need it.

1. The battery is built-in, so do not remove it from the camera.
2. Charge the rechargeable battery with a standard and high-quality DC 5V phone charger or XMARTO solar panel. Do not charge the battery with solar panels from any other brands.
3. Charge the battery when temperatures are between 0°C and 45°C and always use the battery when temperatures are between -20°C and 60°C.
4. Keep the USB charging port dry, clean and free of any debris.
5. Do not charge, use or store the battery near any ignition sources, such as fire or heaters.
6. Do not disassemble, cut, puncture, short-circuit the battery, or dispose of the battery in water, fire, microwave ovens and pressure vessels.
7. Do not use the battery if it gives off an odor, generates heat, becomes discolored or deformed, or appears abnormal in any ways. If the battery is being used or charged, turn off the power switch or remove the charger immediately, and stop using it.
8. Always follow the local waste and recycle laws when you get rid of the used battery.

**Add Device**  
Add devices to your app and access your footage.

**Device Setting**  
Edit or delete your device, turn on/off the app notifications.

**Live View**  
Displays real-time footage of your system.

**Playback**  
Playback recorded videos from your app.

# 11. Pairing a Camera to the Mini NVR

By default, each camera within your kit comes pre-paired to the mini NVR. Additionally, your mini NVR has its own built-in Wi-Fi for secure, uninterrupted video transmission and recording. Pairing allows for the wireless transmission coming from the camera to be detected by the NVR. If you want to add more cameras to your system, the add-on cameras will similarly need to be paired to the NVR.

1. Hold the ON/ OFF switch of the camera to turn it on. Make sure the camera is in **Pairing Mode**. If not, reset the camera to bring it to **Pairing Mode**.

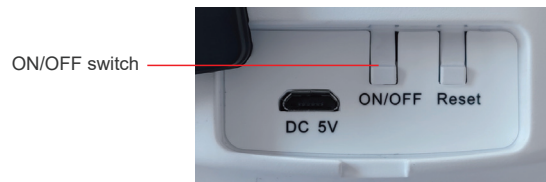

**NOTE:** This should be done locally at the NVR to avoid interference.

2. With the NVR connected to a TV/Monitor, click + icon at the bottom and follow the on-screen guide to pair your camera to the NVR.

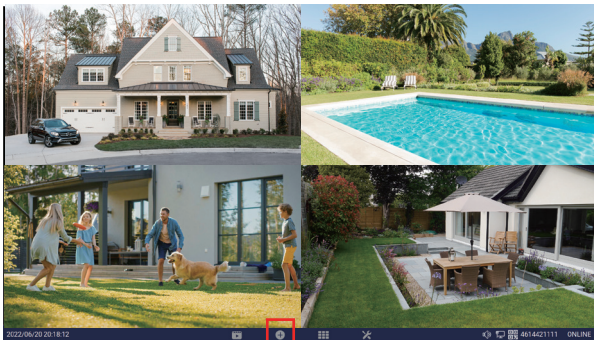

**NOTE:** Icons may vary depending on model number.

3. Once paired successfully, the new camera will appear in a vacant video field.

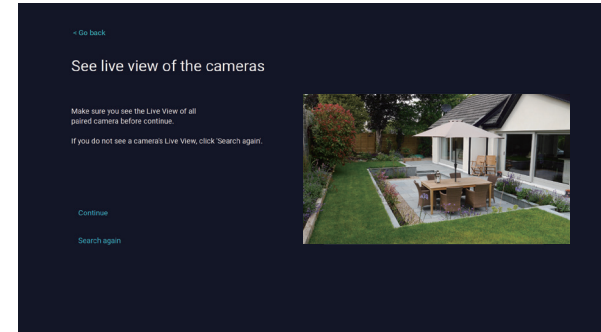

**NOTE:** You cannot exceed the number of NVR channels you have. If you have an 8 channel system, the maximum number of cameras you can have paired is 8.

4. Your add-on camera has now been paired to the NVR using the NVR's built in Wi-Fi.

**NOTE:** Pairing a replacement camera is similar as pairing a new add-on camera. The only difference is you need to delete the old camera from NVR first, and then start pairing the replacement camera to NVR.



## 12. Switch Cameras to 24/7 Working Mode

Battery/ solar powered cameras are designed to work on motion-triggered base. We suggest to let the cameras work in Event Recording Mode.

If in a certain location you do need a 24/7 camera, please purchase a XMARTO plug-in Wi-Fi camera to add to this system.

There is a way to make these battery cameras working 24/7:

1. Use a 5V 1A/2A phone charger and an USB cable to keep the camera plugged to power outlet; so the camera has constant power.

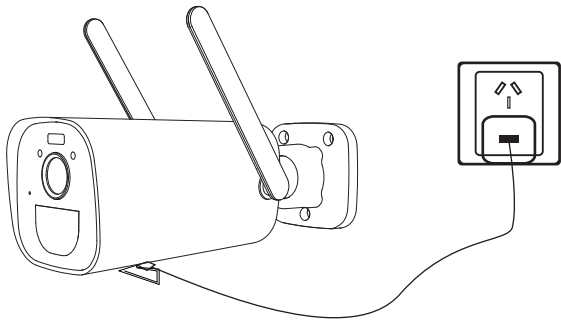

2. Go to NVR's System setting – Camera, change the camera's record mode to **Continuous Record Mode**.

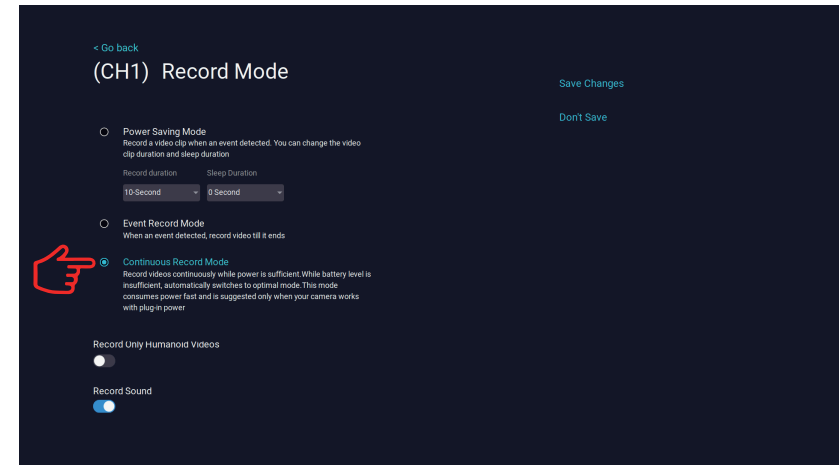

**NOTE:** Using battery-powered cameras with plug-in power will affect the battery life.

## 13. Frequently Asked Questions

### 1. Why I cannot see continuous live video on the monitor?

Because the cameras automatically enter standby mode to save power. As a thermal detection security system powered with solar and batteries, the system works when activities detected and standby when there is no activity.

### 2. Does the system have to be connected to a monitor all the time?

Not really. Connecting the NVR to your TV or monitor enables you to enter the NVR's Linux OS. It is necessary for the initial setup. After the setup finished, you can unplug the NVR from its screen and view the system on your smartphone or tablet.

If you are using a TV, you can switch the signal source to TV programs and switch back to this HDMI connection when needed.

### 3. Does the battery/ solar cameras record 24/7?

Yes but not by default. All solar/ battery-powered security cameras record based on motion detection. If you need 24/7 cameras, please go for XMARTO Wi-Fi security camera system with plug-in power. You can also plug this camera to power with a 5V DC phone charger, then switch to "Continuous Recording Mode" to make it work 24/7.

### 4. Why my cameras run out of batteries fast.

- a) Make sure to fully charge your cameras before you mount them. It shall take 4-6 hours to fully charge them.
- b) When you are using solar panel as the power source, make sure the camera is in **Event Record Mode**. If you want the cameras to work in **Continuous Record Mode**, plug the cameras to wall outlets with 5V power chargers.
- c) Make sure your solar panel is properly installed to obtain solar power.

### 5. Why Need a Solar Panel?

Connecting XMARTO battery camera to solar panel, you will be able to get non-stop power for your camera all day and all night. Also, you don't need to take time to charge your cameras yourselves anymore. It will save you a lot of time.