

## CONTACT US

### Email:

support@xmarto.com

### Website:

24/7 Product Support

FAQs

How-to Videos

Manuals

[www.xmarto.com](http://www.xmarto.com)

### FCC RADIATION NORM

#### FCC

This device complies with Part 15 of the FCC Rules. Operation is subject to the following two conditions: (1) this device may not cause harmful interference, and (2) this device must accept any interference received, including interference that may cause undesired operation.

### FCC Compliance Statement

These limits are designed to provide reasonable protection against frequency interference in residential installation. This equipment generates, uses, and can radiate radio frequency energy, and if not installed or used in accordance with the instructions, may cause harmful interference to radio communication. However, there is no guarantee that interference will not occur in television reception, which can be determined by turning the equipment off and on. The user is encouraged to try and correct the interference by one or more of the following measures:

- Reorient or relocate the receiving antenna.
- Increase the separation between the equipment and the receiver.
- Connect the equipment into an outlet on a circuit different from that to which the receiver is connected.
- Consult the dealer or an experienced radio/TV technician for help.

### CAUTION!

The Federal Communications Commission warns the user that changes or modifications to the unit not expressly approved by the party responsible for compliance could void the user's authority to operate the equipment.

This equipment should be installed and operated with a minimum distance of 8 inches between the radiator and your body.

Please contact XMARTO Support at [support@xmarto.com](mailto:support@xmarto.com) if you have any question.

# Wire-Free Security Camera

## QUICK SETUP GUIDE



# Content

1. What's in the Box	1
2. Before You Start	2
3. Working Diagram	3
4. Camera Introduction	4
5. Set up the Camera - Work as Standalone Camera	5
6. Pair the Camera to a WiFi NVR (optional)	8
7. Install the Camera	10
8. Mount the Camera	11
9. Mount the Solar Panel	12
10. Safety Instructions of Battery Usage	14
11. Troubleshooting	15
12. Frequently Asked Questions	16

## 1. What's in the Box

**DISCLAIMER:** The exact components of your camera, images and quantities may vary depending on your model number. While this QSG will address the setup of your camera.

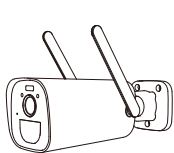

Bullet or Dome Wire-Free Camera(s)

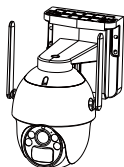

Solar Panel (1 per camera)

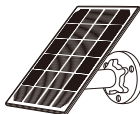

Camera Charging Cable

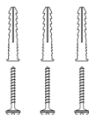

Mounting Hardware



Quick Guide

**NOTE:** For best results, use the included accessories. Third party accessories may not work properly.

## 2. Before You Start

Before setup of the camera, we strongly recommend to recharge the camera overnight to make sure it has 100% power.

1. Use a 5V DC phone charger (not included) and a USB cable (included) to charge the camera.

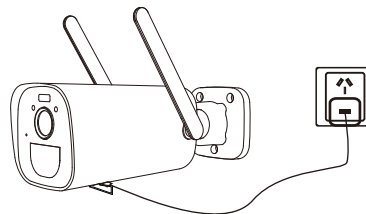

2. The indicator blinks in green while charging; indicator turns off when it's fully charged.

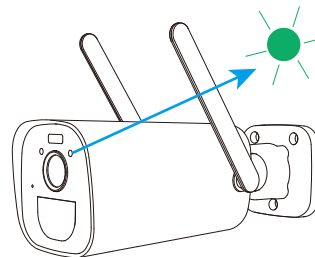

### **NOTE:**

Please use only 5V DC power charger to recharge the camera. Chargers do not meet the standard may damage the batteries.

Please charge the battery at room temperature to avoid damage.

### 3. Working Diagram

#### • 1. The camera works standalone

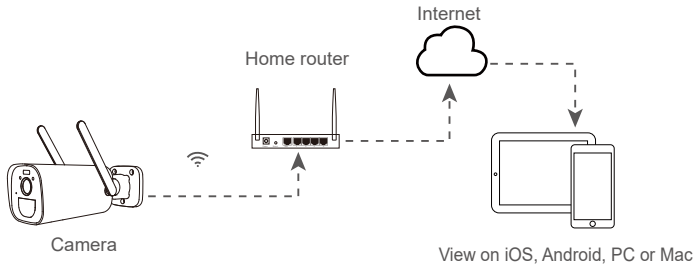

#### • 2. Pair the camera to WiFi NVR

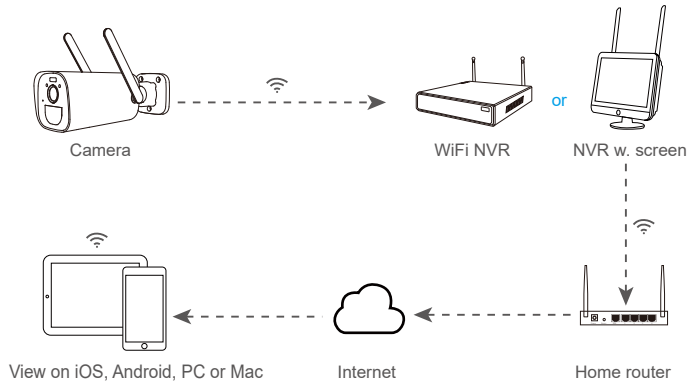

### 4. Camera Introduction

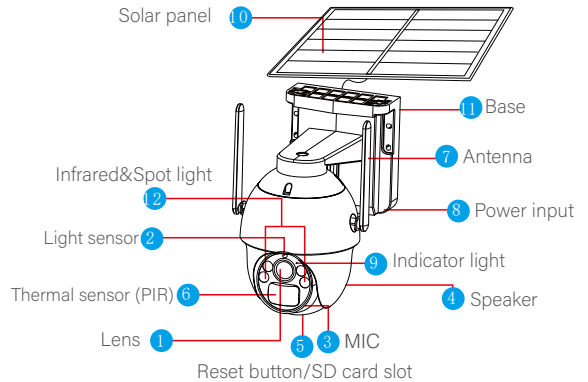
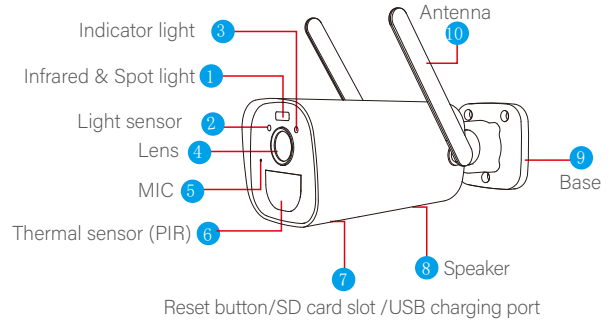

## 5. Set up the Camera - Work as Standalone Camera

### • Download and Install Application

1. Download the WallPixel app from the App Store or Google Play Store and install the application on your device.

**NOTE:** Setup is the same for Smartphone and Tablet.

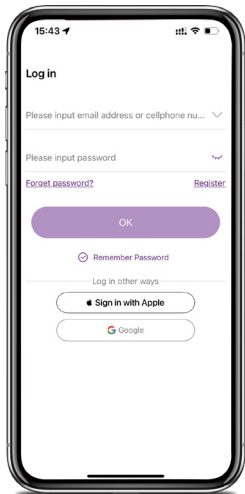

2. Create an account using an email address or phone number as the username; and a password between 6–20 characters.

### • Add the Camera to App

1. Bring the camera and your smartphone close to your WiFi router.

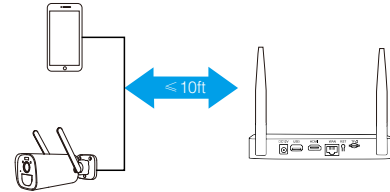

2. Open the rubber cover beneath the camera, hold the ON/OFF button for 2 seconds to turn on the camera.

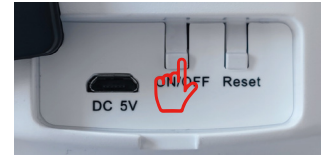

You should hear 'starting pairing' from the camera; and the indicator blinks in red. That means the camera enters pairing mode.

**NOTE:** If the camera did not enter pairing mode, hold the reset button for 5 seconds to bring camera into pairing mode.

## 6. Pair the Camera to a WiFi NVR (optional)

If you want to manage cameras and videos from a NVR, you can pair this camera to a compatible WiFi NVR or camera system.

1. Bring the camera close to your WiFi NVR.

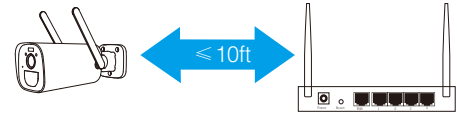

2. Open the rubber cover beneath the camera, hold the ON/OFF button for 2 seconds to turn on the camera.

You should hear 'starting pairing' from the camera; and the indicator blinks in red. That means the camera enters pairing mode.



**NOTE:** If the camera did not enter pairing mode, hold the reset button for 5 seconds to bring camera into pairing mode.

3. Run Wallpixel APP

Tap + to start adding camera, select camera type **Solar/Battery Camera**, follow on-screen guide to setup the camera.

### NOTE

- Camera works with 2.4G WiFi ONLY.
- If the camera was not added successfully, press and hold the reset button for 5 seconds and do it again. Make sure to provide CORRECT WiFi hotspot and password.

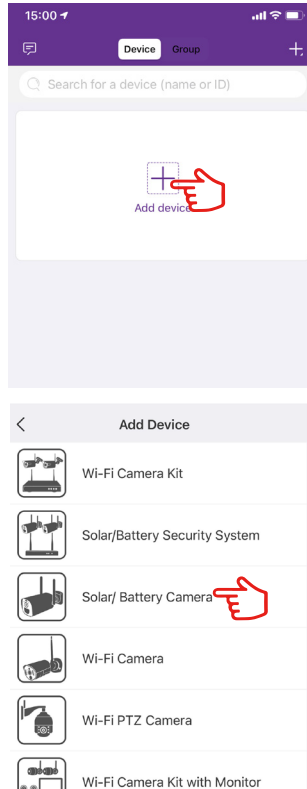

## 7. Install the Camera

3. With the NVR connected to a TV/Monitor, click **+ icon** at the bottom and follow the on-screen guide to pair your camera to the NVR.

For bigger NVR, right click and click **Add Cam by WiFi**.

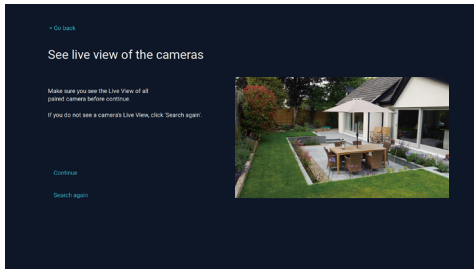
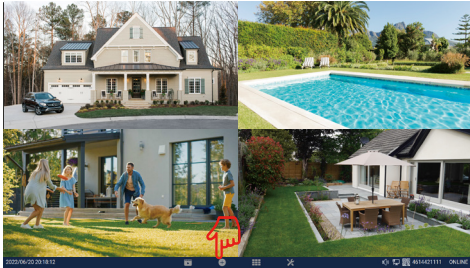

4. Once the camera is paired to NVR, you'll see it displays video on the monitor. You can then go ahead to mount the camera.

**NOTE:** Please mount the camera within NVR's WiFi range.

5. If you failed to add the camera to NVR, press and hold the camera reset button for about 5 seconds to reset the camera, then pair it to NVR once again.

- Install the camera 2-3 meters (7-10 ft) above the ground. This height maximizes the detection range of the motion sensor.

- For dome cameras, they **MUST** be installed upside down for better waterproof performance and better motion sensor's efficiency.

- For better motion detection performance, please install the camera angularly.

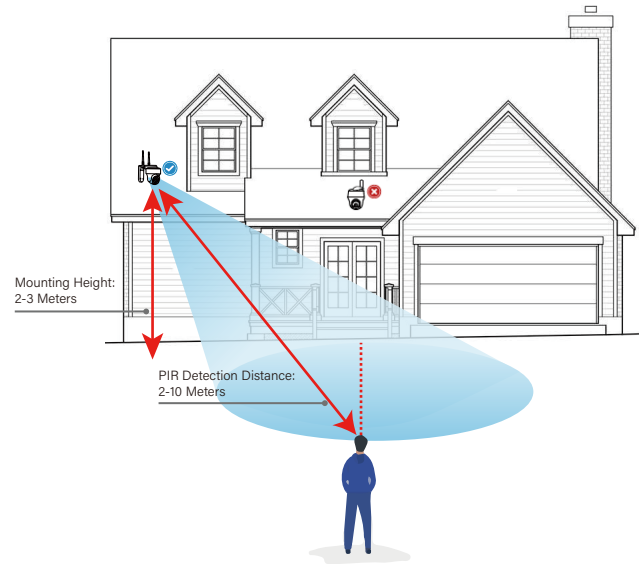

## 8. Mount the Camera

### Mount the Camera

1. Unscrew the bracket from the camera. Use a pencil to mark screw holes on the wall.
2. Fix the bracket on the wall with 3 screws.



3. Attach the camera to bracket and adjust the view angle.

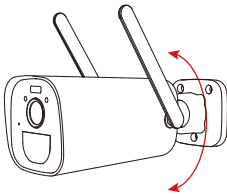

**STOP**

PIR sensor is sensitive to heat changes, please note:

- Avoid installing the camera where has complicated air flows. For example: the air vent of an air conditioner, the side of a fan etc.
- Please do not install the camera against glass or a mirror.
- While installing, avoid lining up the camera with a path. Keeping some angle will help the camera to sense people.
- Do not install the camera upside down. (PIR sensor is the downside.)

## 9. Mount the Solar Panel

Connect your solar powered camera to this solar panel with 3m connection cable (included) to get non-stop power.

1. Please select a position with the maximum sunlight exposure throughout the year for your solar panel. Mount your solar panel facing due south (in the northern hemisphere) or due north (in the southern hemisphere) and tilt it to the appropriate angle for your latitude.

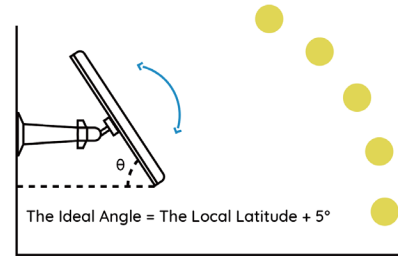

2. Mount the bracket with the screws provided in the package.
3. Slot the solar panel into the bracket and make sure that it's secure.

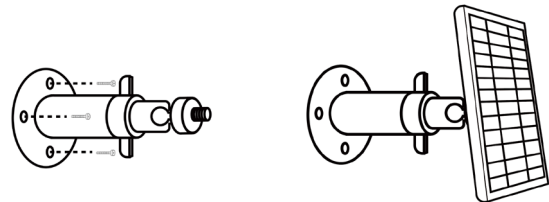



4. Loosen the adjusting control on the bracket and adjust the angle of the solar panel to make it receive direct sunlight exposure, then tighten the adjusting control to fix the solar panel.

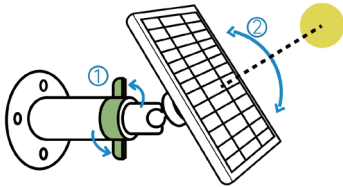

5. Connect the solar panel to the camera with included USB cable.

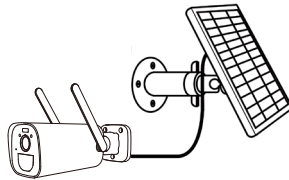

#### NOTE:

1. Make sure that there is NO blocking on the solar panel. The energy harvesting efficiency drops drastically even when a small portion of the solar panel is shaded by other objects.
2. Please don't install the solar panel completely horizontally. Otherwise, your solar panel might accumulate dust and other debris easily. It's advised to install the solar panel angularly to make it receive direct sunlight exposure.
3. Wipe the solar panel regularly to remove the dust and debris.
4. Make sure that the camera is plugged in all the way and that the waterproof wire cover protects the interface between the camera and the solar panel.

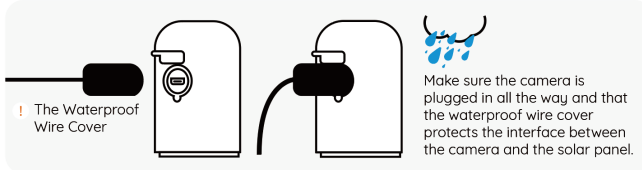

## 10. Safety Instructions of Battery Usage

The camera is not designed for running 24/7 at full capacity or around-the-clock live streaming. It's designed to record motion events and to live view remotely only when you need it.

1. The battery is built-in, so do not remove it from the camera.
2. Charge the rechargeable battery with a standard and high-quality DC 5V phone charger or solar panel. Do not charge the battery with solar panels from any other brands.
3. Charge the battery when temperatures are between 0°C and 45°C and always use the battery when temperatures are between -20°C and 60°C.
4. Keep the USB charging port dry, clean and free of any debris.
5. Do not charge, use or store the battery near any ignition sources, such as fire or heaters.
6. Do not disassemble, cut, puncture, short-circuit the battery, or dispose of the battery in water, fire, microwave ovens and pressure vessels.
7. Do not use the battery if it gives off an odor, generates heat, becomes discolored or deformed, or appears abnormal in any ways. If the battery is being used or charged, turn off the power switch or remove the charger immediately, and stop using it.
8. Always follow the local waste and recycle laws when you get rid of the used battery.

## 11. Troubleshooting

	Trouble	Solution
1	Unsuccessful network configuration	<ol style="list-style-type: none"><li>1. Make sure your phone, camera, and router are close enough.</li><li>2. Note that the camera cannot support connection to a 5G WiFi.</li><li>3. Make sure to provide correct WiFi and password.</li></ol>
2	Device offline	<ol style="list-style-type: none"><li>1. Check your router's Internet connection.</li><li>2. Check the connection between the camera and the router. If you changed the WiFi name or password, you need to reset the camera and setup again.</li><li>3. Check if the camera is out of battery. Recharge the camera when needed.</li></ol>
3	No live view	Restart the app and try again.
4	No push notification	<ol style="list-style-type: none"><li>1. Make sure the app has notification permissions.</li><li>2. Make sure the Motion detection alert of camera setting, and Push notification of App setting are both turned on.</li></ol>
5	No recording	<ol style="list-style-type: none"><li>1. Please insert an SD card to the camera before power on; check SD card status in camera setting. If it is abnormal, try to format the SD card.</li><li>2. Make sure the camera PIR switch is turned on.</li><li>3. Make sure the camera recording switch is turned on.</li></ol>

## 12. Frequently Asked Questions

### 1. Does the camera work 24/7?

Yes, but we do not recommend. Battery/solar powered cameras are designed to work on motion-triggered base. We strongly suggest letting the camera work in Event Recording Mode.

If you need a 24/7 working camera, please purchase a plug-in power Wi-Fi camera.

Here is the way to make this battery camera work 24/7:

Use a 5V 1A/2A phone charger and an USB cable to keep the camera plugged into power outlet, so the camera has constant power. Then open the WallPixel app, go to **camera settings – Record Setting**, change the **Record Mode** to **Continuous Record Mode**.

### 2. Why my cameras run out of batteries fast.

- a) Make sure to fully charge your cameras before you mount them. It shall take 4-6 hours to fully charge them.
- b) When you are using solar panel as the power source, make sure the camera is in **Event Record Mode**. If you want the cameras to work in **Continuous Record Mode**, plug the cameras to wall outlets with 5V power chargers.
- c) Make sure your solar panel is properly installed to obtain solar power.

### 3. Why Need a Solar Panel?

Connecting battery camera to solar panel, you will be able to get non-stop power for your camera all day and all night. Also, you don't need to take time to charge your cameras yourselves anymore. It will save you a lot of time.

Please contact XMARTO Support at [support@xmarto.com](mailto:support@xmarto.com) if you have any question.