

MASSAGE BATHTUB

INSTALLATION INSTRUCTION AND OWNER'S MANUAL

EMPV-59JT408

EMPV-67JT408



TABLE OF CONTENTS

Introduction..... 1

Installation

Preparation before installation..... 2
Precautions for installation..... 3
Size chart..... 4
Installation instruction..... 5-6

Operation

Precautions for use..... 7
Accessories instruction..... 8-9

Care and Maintenance

Precautions for care and maintenance..... 10
Care and Maintenance procedures..... 11
Troubleshooting guide..... 11

Introduction

In order to use our products safely and effectively, please read this instruction carefully. Improper installation, operation and maintenance will cause the damage to the products and charge you extra repairing fee.

- Thank you for you to choose our massage bathtub series;
- We provide a lifetime warranty after-sale service, please fill warranty registration form accurately;
- If you need any help, please contact local distributor or our company directly;
- Our company reserve the right to change all the models listed in this instruction without prior notice;
- This instruction applies to the listed products as below.
- Because of the difference of the market requirement and individual custom product, please refer to the corresponding content in this instruction according to the product and its functions you choose. In this way, you can install and operate the product correctly.

- In order to install the product correctly and safely by the installer, and you can use and maintain this product correctly and safely, please pay much attention to the warning sign as below.

The warning symbol's meaning is as below:

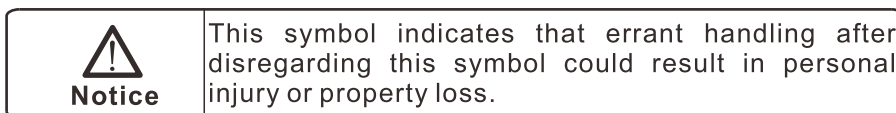

- In order to install, use and maintain this product correctly and safely, please read and understand this instruction totally.
- This instruction is a valuable source of product information to help the end user use the product safely and correctly. Please take good care of it and keep it from getting lost or soiled.

Preparation before installation

- Make sure the place you install the bathtub is strong enough to bear the total weight of bathtub, maximum water volume and the user.
- Waterproofing process must be made in the place of bathtub installed, or down stair will get damaged if water leaks.
- The installed place must equip with water supply, power supply and drainage:
 - This product uses universal home power.

 Notice	<p>*External circuitry need to equip with high sensitive and fast type leakage protection switch. (Induced current rating below 15MA, trip time should less than 0.1 second, rated current is above 30A.)</p> <p>* The product should be installed the grounding and electric leakage switch by a qualified licensed electrician.</p>
--	---

- Please reserve the drainage hole $\geq \phi 1.97$ inches, make sure the drainage pipes accord with the water valve.
- User need to reserve the connectors of 1/2" external thread cold/hot water hoses, which outstand the wall 1.18 inches. It is suggested to install a valve in each pipe, the location of the installed should be designed by user, which is convenient for maintaining.
- As each bathroom or power and drain of each bathtub is slightly different, please place the bathtub according to the actual situation, the following illustration as a reference layout:

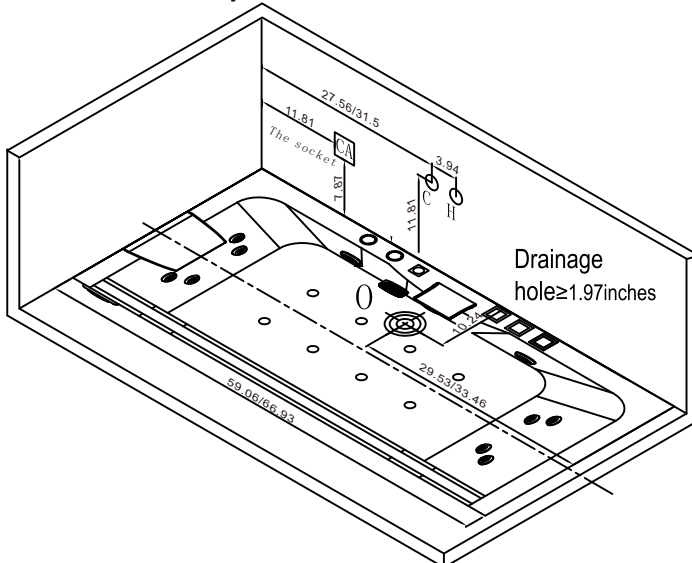

 Notice	The safe distance between power supply and water supply should be not less than 30cm.
--	---

Precautions for installation

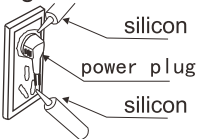
 Notice	<ul style="list-style-type: none">• Please check whether all parts are complete. If you have any question, please give feedback to our company in time.• After opening the box, please immediately dispose of unneeded packaging. Or it may cause the personal injury by the wooden frames, nails, cardboard or sealing straps which are placed carelessly.• In addition, please do not let the children to play with the packing material. Or it will cause personal injury.
	<ul style="list-style-type: none">• Parts containing live parts, except parts supplied with safety extra-low voltage not exceeding 12 V, must be inaccessible to a person in the bath• Earthed appliances must be permanently connected to fixed wiring• Parts incorporating electrical components, except remote control devices, must be located or fixed so that they cannot fall into the bath• Please do not use other power, except specified power Or it may cause fire or electric shock.• Electrical leakage protection switch should be installed outside the bathroom. Or it may cause fire or electric shock.• Do not use the broken power supply, power plug or the loose socket. Or it may cause fire or electric shock.• Do not modify the power supply cord, use it with an extension cord or combine it with other equipment using multiple plugs. Doing so could lead to shocks, overheating or fire.• Please make sure the power plug is waterproof protection with silicon. Or it may cause fire or electric shock by water infiltration. 
	<ul style="list-style-type: none">• Before the installation finish, please use cardboard to protect the bathtub or it may lead the damage of the bathtub.• Do not put the fire on the bathtub, such as a lighted cigarette, or it may lead the damage of the bathtub.• Do not stand on bathtub while working. Doing so could cause one to slip and fall or could otherwise damage the product.• Install securely, in accordance with the Installation Manual. Improper installation can lead to water leaks that damage or ruin household property.• After finish the installation, the product should go into trial operation fully to check the installation is proper or not.

Size chart

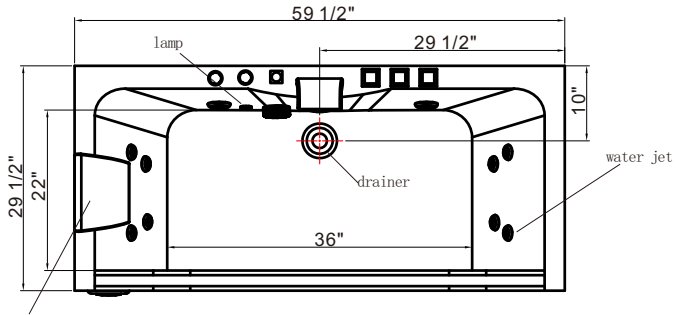
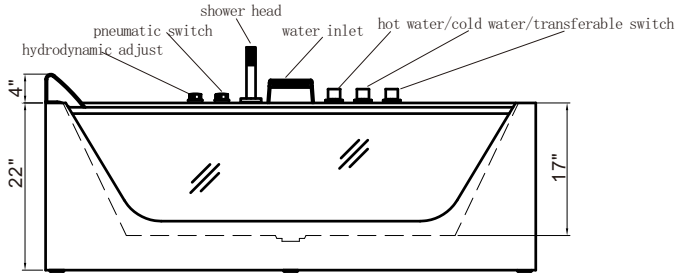

pillow rest

EMPV-59JT408

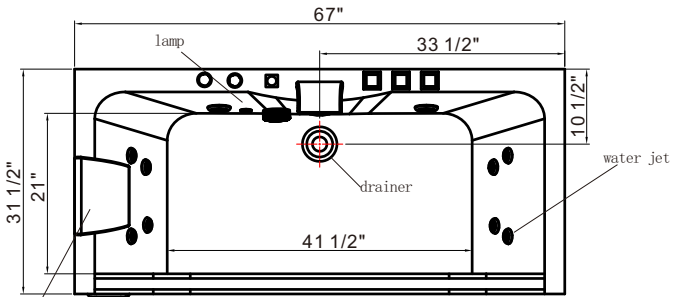
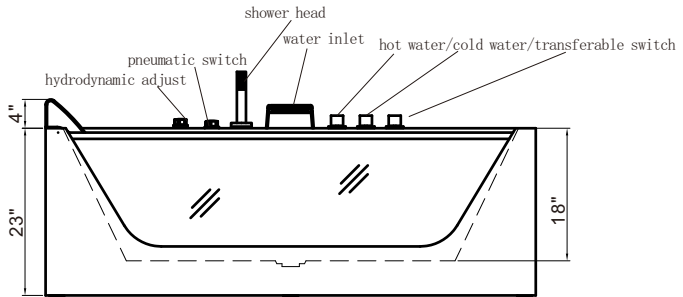

pillow rest

EMPV-67JT408

Installation instruction

● Inspection before installation

Although all our massage bathtub are water tested before they leave our factory, there may be some loose of the hose connections due to the transport. We need water test the product before installation. The steps are as follow:

- a. Place the tub on a flat surface in an area where it may be drained after testing. And adjust the feet to make the bathtub level;
- b. Check if there is any loose of all the connection system;
- c. Close the door, fill the tub with water to the overflow and allow standing for 10 minutes to inspect the tub for leaks;
- d. Insert the plug, start all the function for few minutes (which includes the functions of massage, air bubble, waterfall and so on), inspect the tub completely any defect must be reported to your dealer/distributor prior to installation in order to have it covered under warranty.

● Adjust the leveling feet

According to different sizes bathtubs, we design about several leveling feet to adjust the bathtub. Please use a wrench or level ruler to level the bathtub.

Note: If the bathtub is not level, it may

lead :

- noise increased;
- remaining water in the hoses or the drainage;
- bathtub shaking;

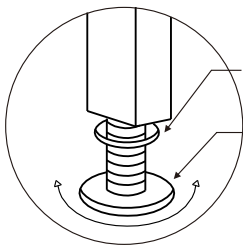
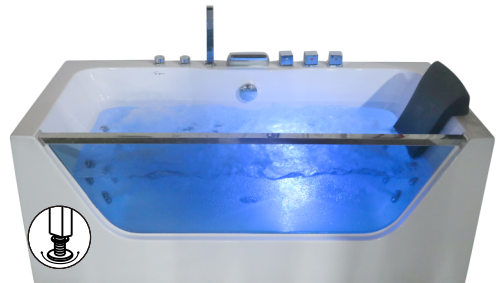

2.Adjust screw nut to the level position

1.Adjust height of the leveling feet

Installation instruction

● How to connect the water ?

For ease of use, our bathtub is equipped with stainless steel cold and hot water hoses (connector \varnothing 1/2"). Please connect the cold and hot water hoses to the bathroom's cold and hot water hoses accordingly.

Before connect bathtub water inlet pipe, first open water pipe for a period of time, then put filter screen to ensure that the debris will not enter the bathtub pipe. So that we can effectively extend the life of the fitting.

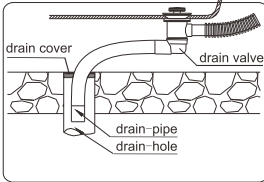
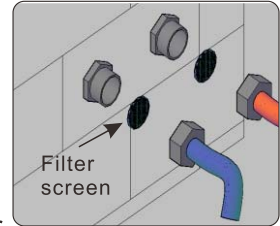

Insert the drain-pipe to the drain-hole on the floor, and then cover it with water retaining cover to prevent waste water spilling.

 Notice	The red hose stands for hot water hose; the blue hose stands for cold water hose; Drain-pipe should be installed with slope above 1:50; Do not hold the drain-pipe and cold/hot water hoses when moving the bathtub, and do not crash it with hard objects.
--	---

● How to connect the electricity?

Please install a proper dedicated plug with ground electrode to the power line. And then insert the plug firmly.

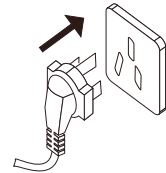

Make sure the ground is connected: one side of the ground should be connected to the ground terminal of the motor and the stainless steel frame; the other side should be connected to the ground wires of the plug.

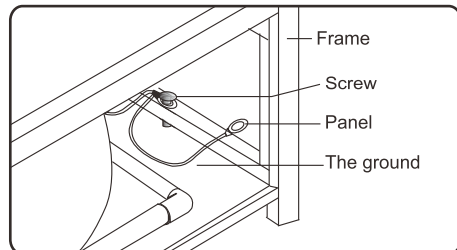

 Notice	The bathtub must be connected to the ground. Power outlet must be sealed well. Make sure the surface of each wire is intact.
--	--

Precautions for use

 Notice	<ul style="list-style-type: none">• This instruction is for the massage bathtub series, not just for a certain model. Please refer to the model and configuration you choose when using the product.• Use this unit only for its intended use as described in this manual. Do not use attachments not recommended by the manufacturer.
	<ul style="list-style-type: none">• Children shall not play with the appliance.• Cleaning and user maintenance shall not be made by children without supervision.• Do not permit children to use this unit unless an adult closely supervises them at all times. Supervision is also required when an elderly or handicapped individual uses whirlpool bath.• For the early months of pregnancy, pregnant or possibly pregnant women should limit whirlpool water temperature to 100°F(38°C), because the excessive water temperatures have a high potential for causing fetal damage.• Person with a medical history of heart disease, low or high blood pressure, circulatory system problems or diabetes should consult a physician before using a whirlpool.• The use of drugs or alcoholic beverages before or during whirlpool use may lead to unconsciousness with the possibility of drowning.• The water in a whirlpool should never exceed 104°F(40°C). Water temperatures between 100°F(38°C) and 104°F(40°C) are considered safe for a healthy adult. Use time should be limited to approximately 30 minutes, followed by a shower to cool down. Lower water temperatures are recommended for extended use (exceeding 10-15 minutes) and are definitely recommended for younger children. If you become nauseous, dizzy or develop a headache, get out at once and cool down. Get medical attention if symptoms persist. Check with a physician before using whirlpool again.• Persons using medication should consult a physician before using a whirlpool since medication may induce drowsiness while other medication may affect heart rate, blood pressure and circulation.
	<ul style="list-style-type: none">• The thermostatic mixer can maintain the temperature of the water input, please use carefully according to the operating instruction to avoid the scald or catch a cold.• Do not operate this unit without the suction cover over the suction fitting. This suction cover is a safety device that reduces the potential hazard of hair or body entrapment. Keep hair and body away from suction cover when the pump is running.• Never drop or insert any object in any opening within the whirlpool.• Never operate electrically connected devices in or near the bath. No electric appliances should be within 5 feet/1.5 meters of this bathtub (such as hair dryers, lamp, telephone, radio, television and so on.)

● Square three-piece set faucet :

- A. cold water switch
(Marked with letter C)
- B. hot water switch
(Marked with letter H)
- C. waterfall/sprinkling style transferable switch
(Marked with Icon)

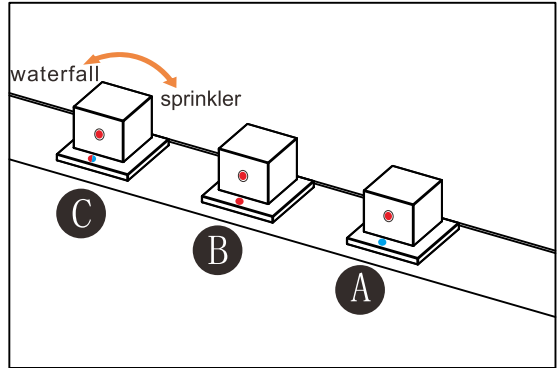

C. Waterfall/Sprinkler transferable switch (Marked with Icon)

B. Controls the water inflow and the water temperature: Up the handle to open, otherwise down the handle to close water inflow (You pull up the handle higher; the water force will be stronger. Otherwise, the water force will be weaker.) ;

You can rotate switch B to left or right to set the water temperature you want.

● Water jets use:

Rotating the head of water jets clockwise/anticlockwise can adjust the water force; Turning the head of water jets up, down, left or right can adjust the angle of inflow.



Big water jets

turning the head of water jets up,down left or right can adjust the angle of inflow.

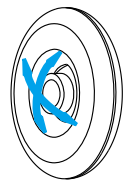

Small water jets

Operation

Accessories instruction

● Pneumatic switch



Press the above button of pneumatic switch then massage function and 7 color led light turned on together; Press the button again, then turned off.
(Only for the model with pneumatic switch)

● Hydro massage flow rate control switch



Rotate hydro massage flow rate control switch clockwise, then the water column strength smaller; rotate the knob anticlockwise, then the water column strength stronger.
(Only for the model with hydro massage flow rate control switch)

● Drainage

1. Manual drainage

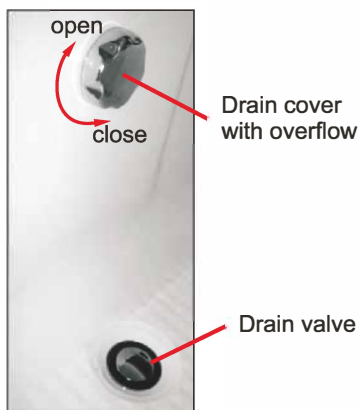

Rotate the cover clockwise to close the drain;
Rotate the cover anticlockwise to open the drain;
When the water is over the maximum water level, the excess water will be drained by overflow.

Care and Maintenance

 <p>Notice</p>	<p>Always implement the countermeasures for preventing freezing. Must empty the bathtub and the water in the pipe during the winter use. It is possible that the pipes could freeze, rupturing the pipes or equipment.</p>
	<p>Use no water other than standard tap water. The use of well water could cause corrosion, which could lead to leaks.</p>
	<p>Bathtub should be prevented irradiating by ultraviolet light or bright light, otherwise it will accelerate the aging and damaged.</p>
	<p>Keep far away from cigarette butts, hair dryer and other heat sources, the product will be damaged due to high temperature deformation.</p>
	<p>When not use the bathtub, please keep it ventilation and dry; avoid contact with corrosive substances; no electricity and no water.</p>
	<p>To avoid damage when the appliance is left empty for an extended period Do not drop or strike the bathtub with hard objects. Doing so could crack or scratch the bathtub or cause leaks that damage or ruin household property.</p>
	<p>When the product is at work, you cannot cut off any connection lines and split bus master and control panel (any part of the control panel and the bus master cannot be split by the user). Doing so may cause product leakage, electric shock, or other accidents.</p>
	<p>The ground fault circuit interrupter (GFCI) should be tested regularly, it is better to test before each use.</p>
	<p>Use water or mild detergent to clean the products. Do not use acids, alkalis, organic solvents class of chemicals and acidic, alkaline cleaning agents. Otherwise it will damage the product surface. When using water or a neutral detergent cannot remove stains, please use a clean cloth which is impregnated by a little alcohol to remove stains.</p>
	<p>Plating parts maintenance: use cotton fabric to scrub.</p>
<p>Light scratches and dulled areas may be restored to original luster by using NO. 1200 waterproof sandpaper dipped in water to coarse grinding, then using NO. 2000 waterproof sandpaper dipped in water to fine grinding, finally polishing with soft cloth and polishing agent.</p>	

Care and Maintenance

- Regular care of your bathtub will keep it clean and working at its best. Pump and pipe circulation systems should be flushed before first use and on a monthly basis when product is under normal use. Below are the recommended procedures for cleaning:
 1. Do not run the jet massage system dry;
 2. Fill the tub with hot water (about 40°C) 2-3 cm above the jets and add 2-3 teaspoons of low foaming detergent such as dishwashing machine detergent;
 3. Turn on all the functions and run for 10 minutes;
 4. Drain tub completely;
 5. Fill tub with cold water above jets;
 6. Turn on all the functions and run for 15 minutes;
 7. Drain tub completely;
 8. Cleaning the "suction cover": Clean and remove any hair or lint from the suction cover. On a monthly basis, unscrew the suction cover and clean away any hair, lint or debris from the cover and housing, then remount the cover in place. Some suction covers are not designed to be removed; only suction covers that have screws on the cover, visible from the inside of the tub, can be removed.

	Notice	Never operate the unit with the safety suction cover off
---	---------------	--

● Troubleshooting Guide (Form two)

SYMPTOMS	PROBLEMS	SOLUTIONS
Water pump will not start	1. Air hose connected to the pneumatic switch is loose; 2. Pneumatic switch does not work flexible; 3. Disconnected to the power or defective wiring; 4. There are some debris stuck the pump impeller; 5. Water level does not reach the minimum water level of the bathtub;	1. Tighten the connection of air hose and pneumatic switch; 2. Adjust the pneumatic switch; 3. Insert the plug; 4. Clean the debris; 5. Inflow water until it reaches the minimum water level of the bathtub.
Cannot control the hydro massage flow rate	1. Power is not normal (Low voltage); 2. Pneumatic switch does not work; 3. Air hose is not connected tightly.	1. Insert the plug tightly; 2. Adjust pneumatic switch; 3. Connect air hose tightly.
Water hose leaks	1. Rubber ring is not good; 2. Screw nut is not tightened, the connection is not good;	1. Change a new rubber ring; 2. Tighten screw nut and make sure its connection is good.