

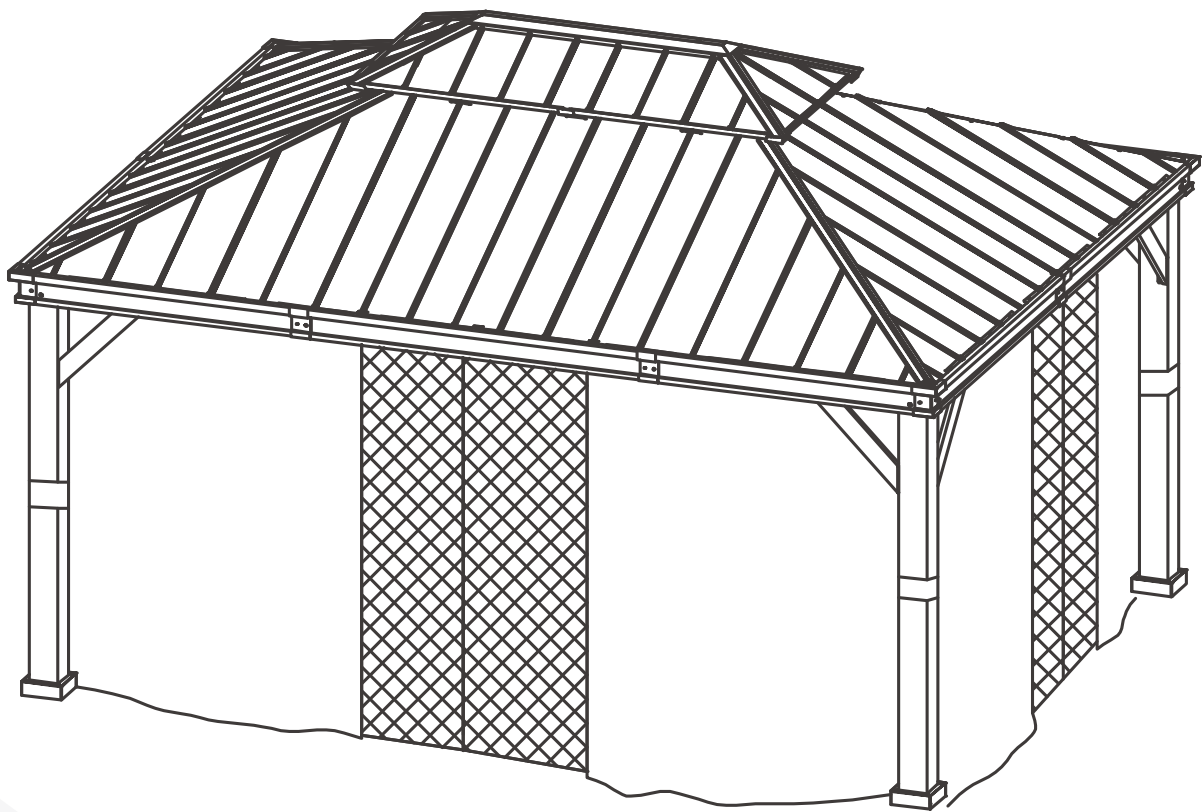

ITEM#  
SGS-D00401-5

# 12'×16'

## Alps Hardtop Gazebo with Double Roof



# Assembly Manual



*Thank you*

Thank you for your purchase of Olilawn Gazebo and follow this assembly and operation guide.

To reduce personal injury and damage to your gazebo, please attach your gazebo curtain to the post when it is incoming over **20 mph** wind.

We recommend a **five-person team** for assembly and disassembly.

If you like our products,  
please follow more.

The logo for Olilawn features a stylized 'O' composed of three overlapping circles of varying sizes, followed by the word 'lilawn' in a bold, lowercase, sans-serif font.

# Warnings and Cautions

- Please retain this instruction for future usage and read carefully before assembly.
- Make sure you have all the parts & hardware as the item list shows.
- 5 adults or more are recommended to install your gazebo.
- Do not discard any of the packaging until you have checked that you have all the parts and pack of fittings.
- Check all bolts for tightness before use, and periodically check and tighten bolts to ensure your gazebo works properly.
- Some parts might have sharp edges/corners. Please follow basic safety precautions to reduce the risk of hurt.
- It is essential to place the gazebo on level ground and not less than 6 feet from any obstruction such as fences, garages, the house, overhanging branches, laundry lines, or electrical wires.
- Lastly, be careful the parts are not swallowed by pets and kids.

# Pre-assembly

## TOOLS THAT MAY BE REQUIRED (NOT included in the boxes)

\*NOTE: Tools / equipment are not shown to actual size and scale

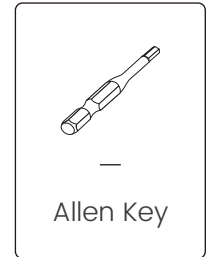
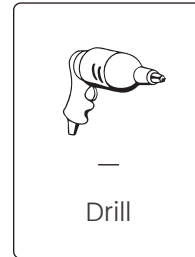
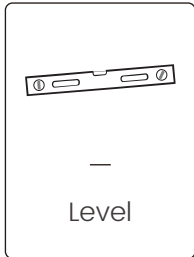

## EQUIPMENT REQUIRED (NOT included in the boxes)

\*NOTE: Equipment are not shown to actual size and scale

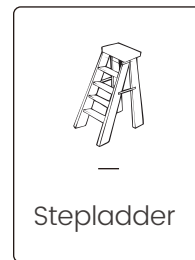

# Matters needing attention



Five or more people are required for assembly.



Do not fully tighten screws prior to complete assembly.

# Mounting Blueprint

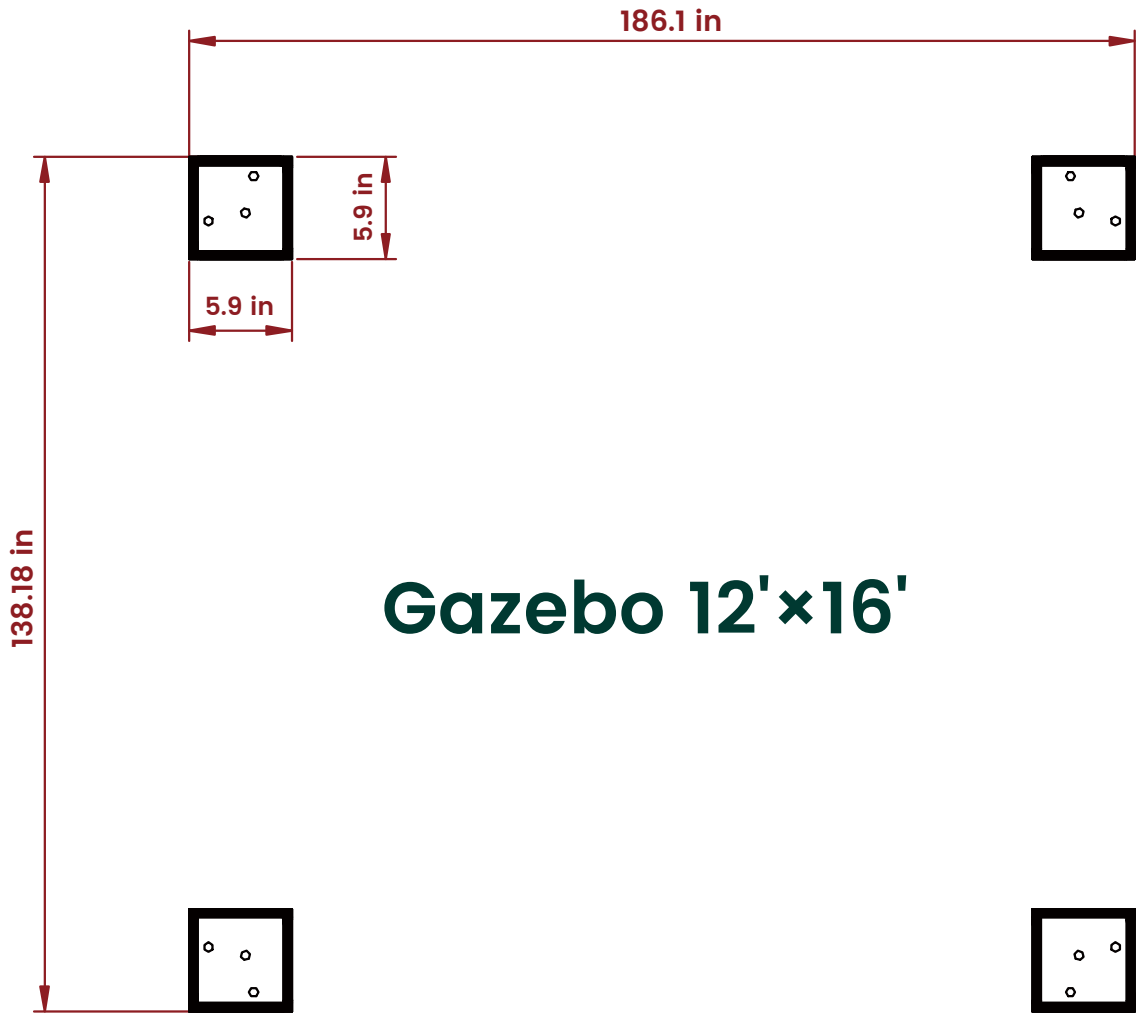

1

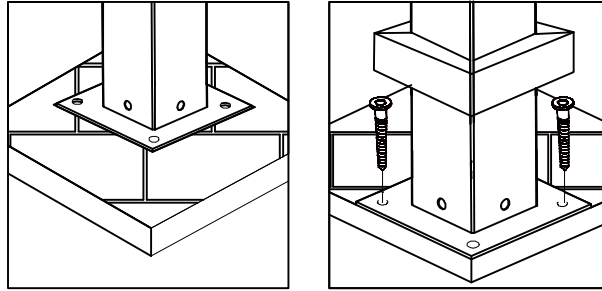





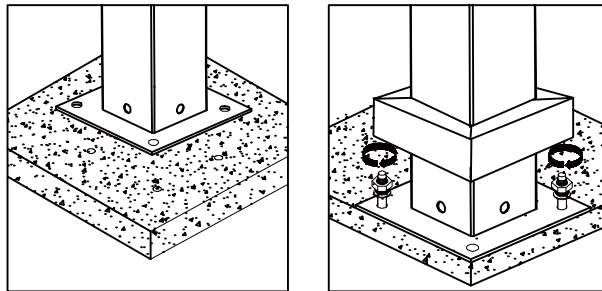





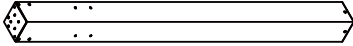
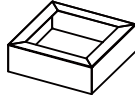
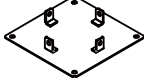





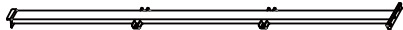

If the deck is hard wood, you can use M6×80 expansion bolts to mount the gazebo.  
(Not included in the parts)

2

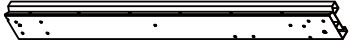

If the ground is concreted, you can use M6×80 hexagon bolt to mount the gazebo.





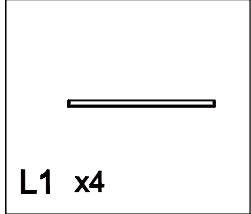
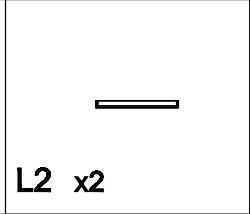
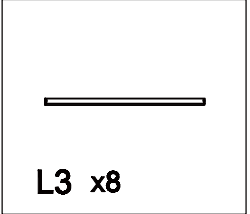
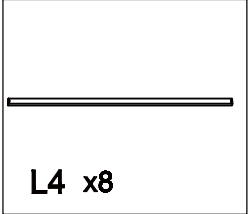
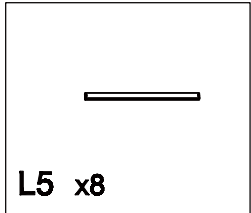
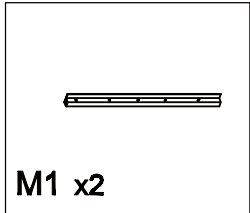
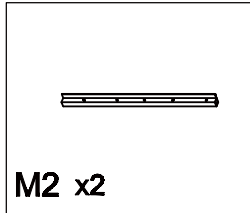
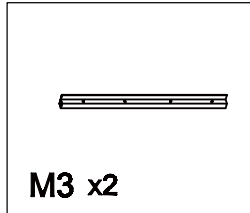
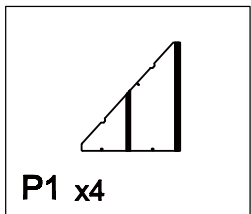
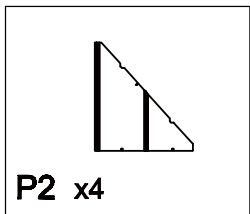
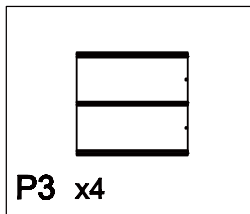
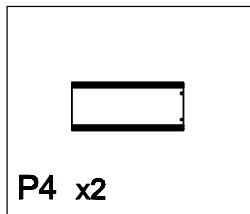
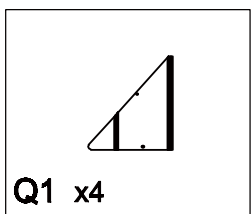
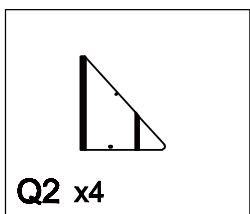
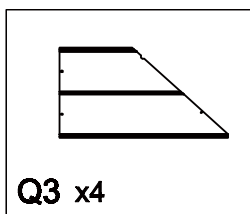
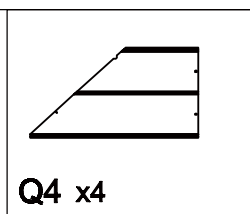
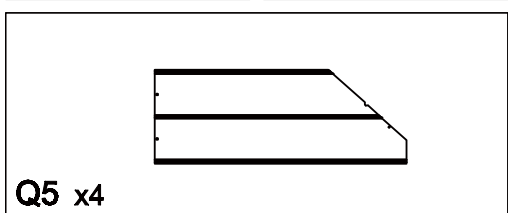
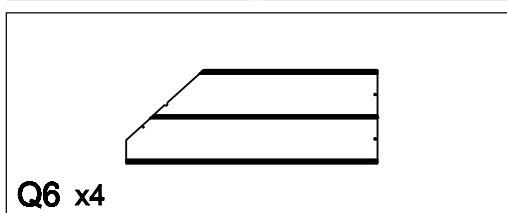
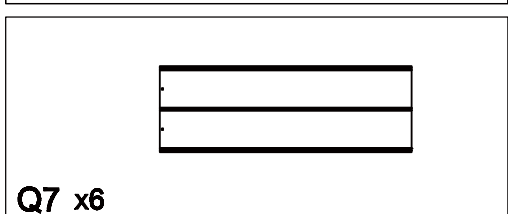
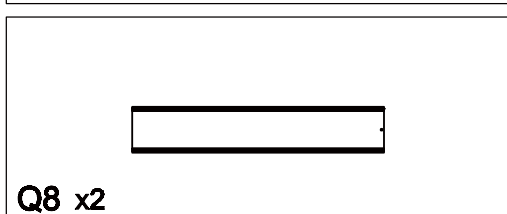
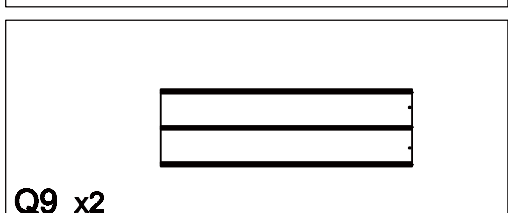
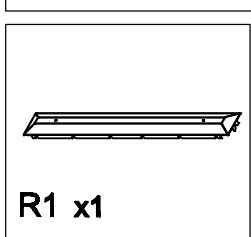
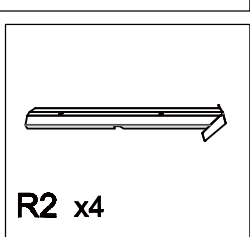
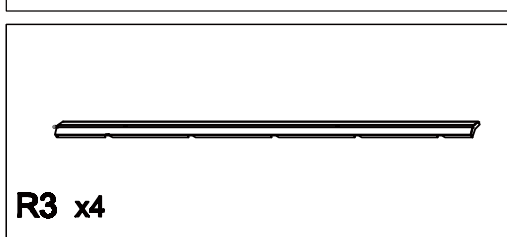

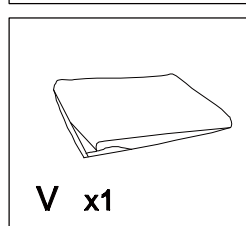
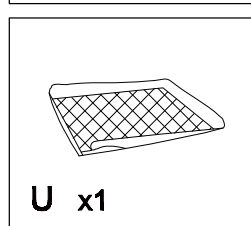
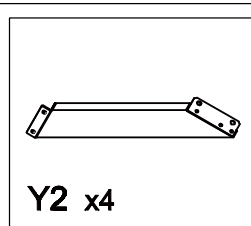
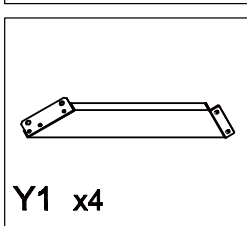
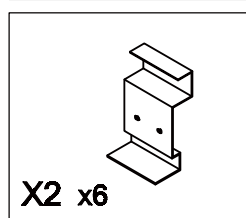
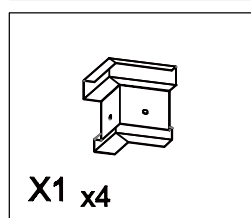
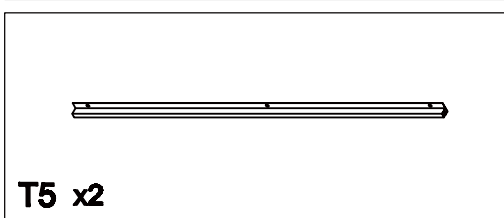
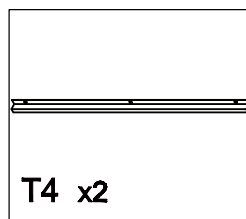
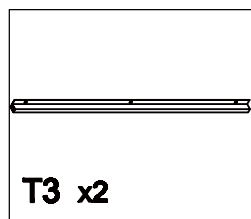
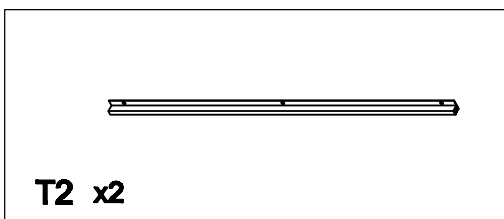
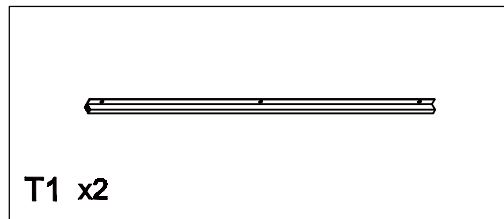
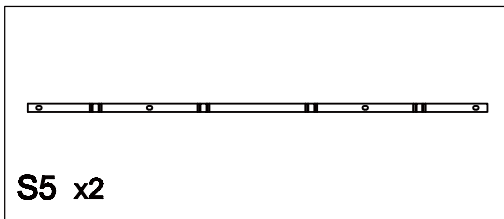
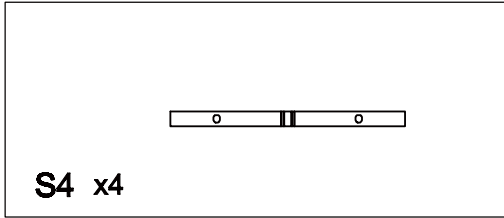
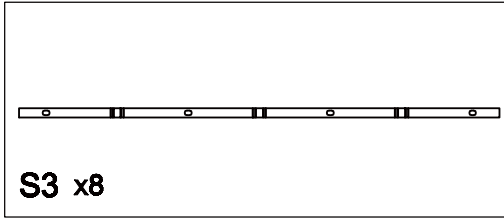
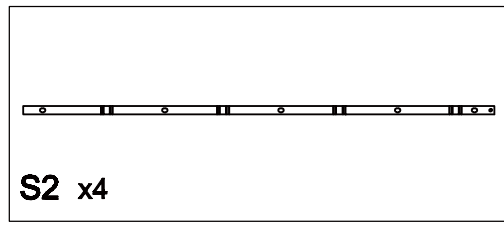
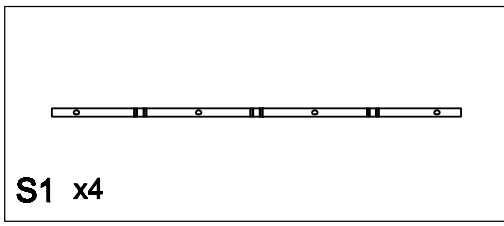

# Checklist

	 <p>A x4</p>	 <p>B2 x4</p>	 <p>C2 x4</p>	
	 <p>D x1</p>	 <p>E1 x2</p>		
	 <p>E2 x2</p>	 <p>E3 x4</p>	 <p>F1 x4</p>	 <p>F2 x2</p>
	 <p>G x4</p>		 <p>H x8</p>	
	 <p>J1 x8</p>	 <p>J2 x4</p>	 <p>J3 x4</p>	 <p>J5 x6</p>
	 <p>J7 x6</p>	 <p>P x1</p>	 <p>K1 x2</p>	
	 <p>K2 x2</p>		 <p>K3 x2</p>	
	 <p>K4 x2</p>		 <p>K5 x2</p>	
<b>1</b>				

	 L1 x4	 L2 x2	 L3 x8	 L4 x8
	 L5 x8	 M1 x2	 M2 x2	 M3 x2
	 P1 x4	 P2 x4	 P3 x4	 P4 x2
	 Q1 x4	 Q2 x4	 Q3 x4	 Q4 x4
	 Q5 x4		 Q6 x4	
	 Q7 x6		 Q8 x2	
	 Q9 x2			
	 R1 x1	 R2 x4	 R3 x4	
<b>2</b>				

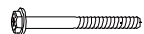

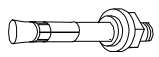
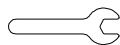

 <b>ST5 x 15</b> <b>AA x20</b>	 <b>M6</b> <b>BB x12</b>	 <b>M6</b> <b>DD x12</b>	 <b>M6 x 20</b> <b>FF x428</b>
 <b>M6 x 15</b> <b>GG x22</b>	 <b>M6 x 55</b> <b>JJ x22</b>	 <b>D8 x 180</b> <b>PP x8</b>	 <b>M6 x 40</b> <b>QQ x16</b>
 <b>HH x128</b>	 <b>M6 x 80</b> <b>UU x8</b>	 <b>M6</b> <b>Z1 x2</b>	

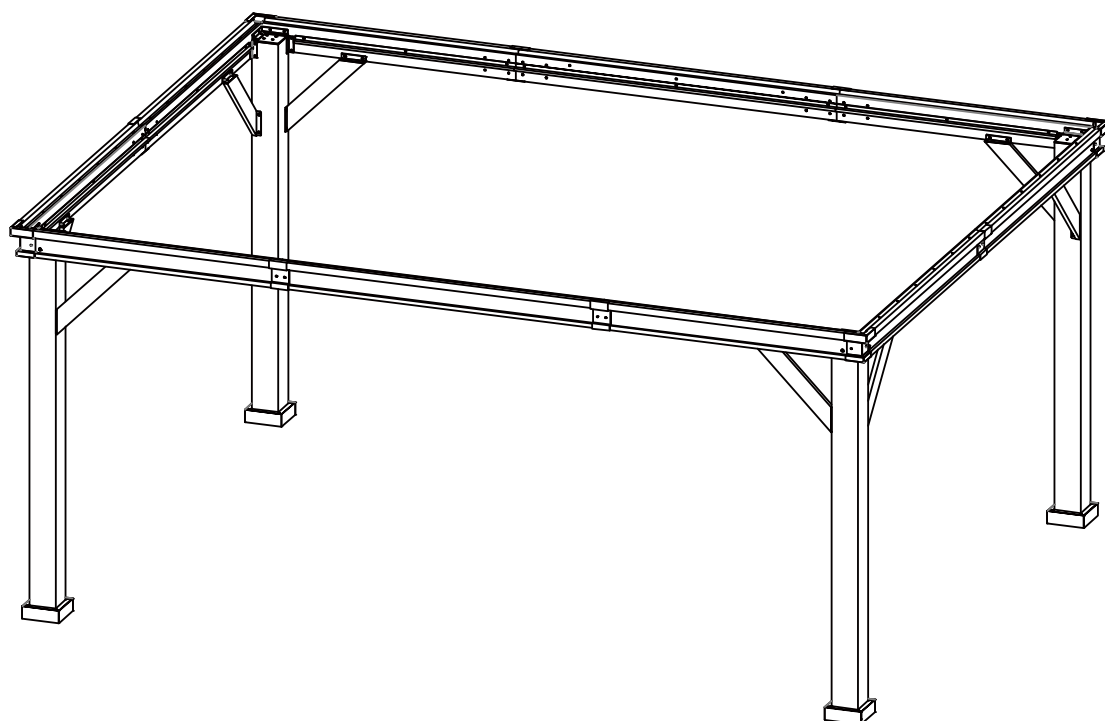

**STEP 1**



**A** x4

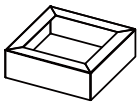

**B2** x4

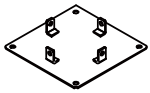

**C2** x4



**J1** x8



**J2** x4

**STEP1-1**

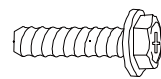
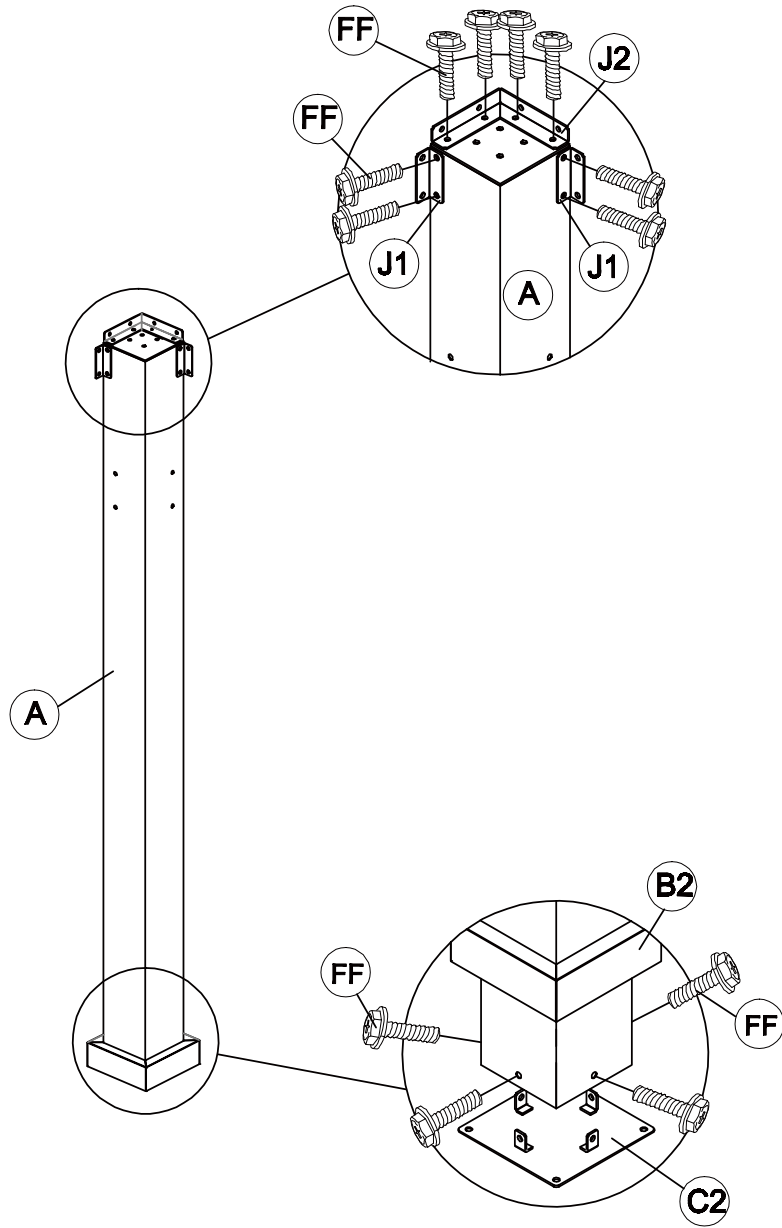

**FF** x48

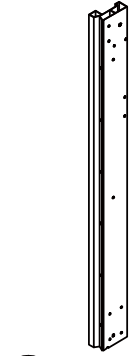

K1 x2

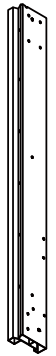

K2 x2



J7 x2

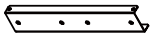



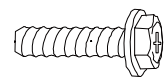
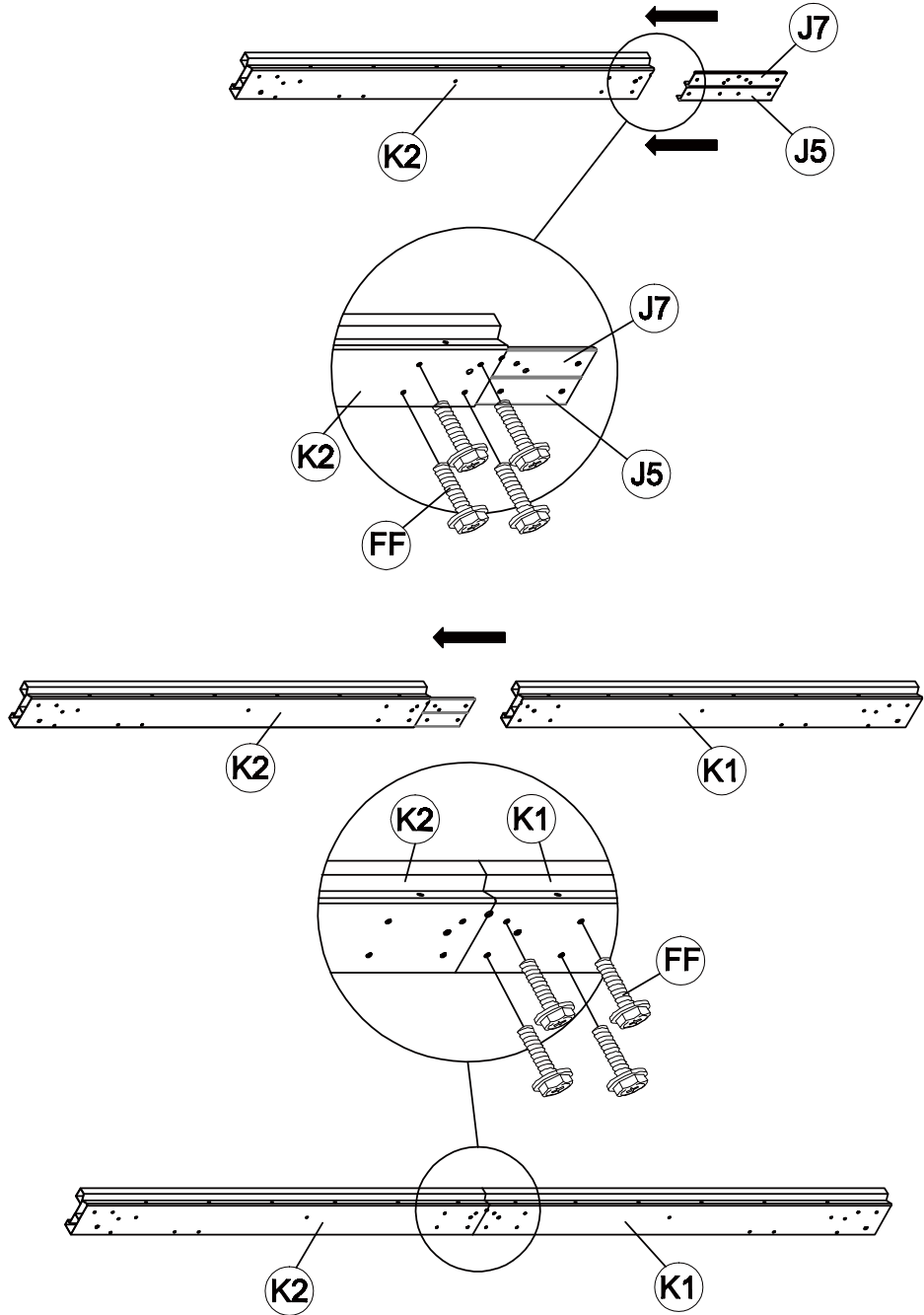

J5 x2

**STEP1-2**

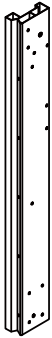
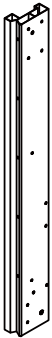

FF x16

-  **K3** x2
-  **K4** x2
-  **K5** x2
-  **J7** x4
-  **J5** x4

**STEP1-3**

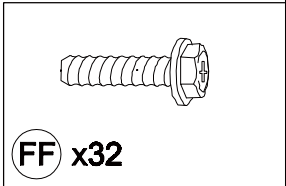
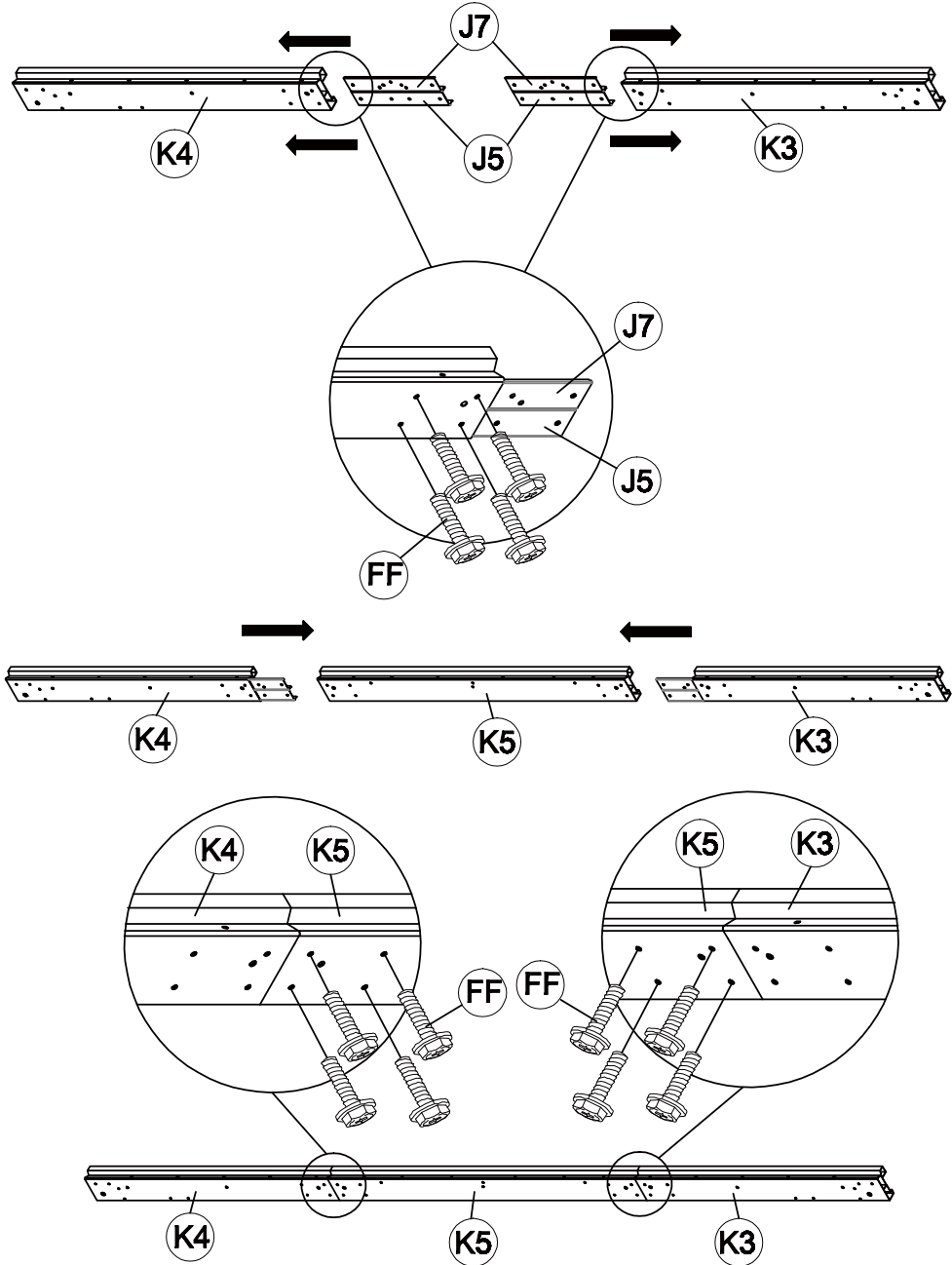

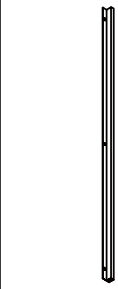

T1 x2

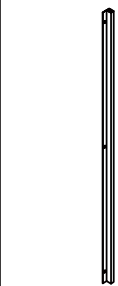

T2 x2

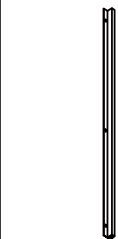

T3 x2

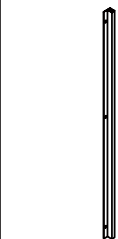

T4 x2

**STEP1-4**

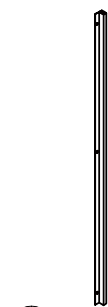

T5 x2

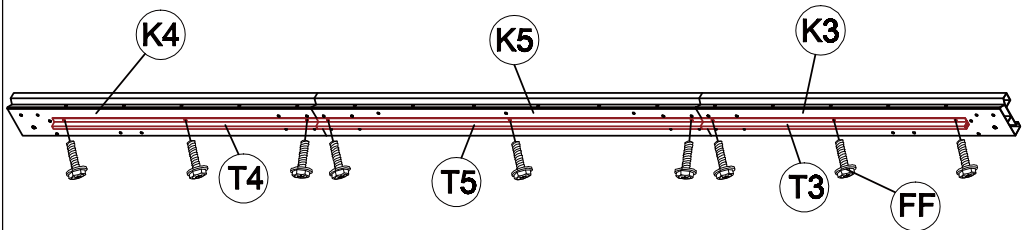
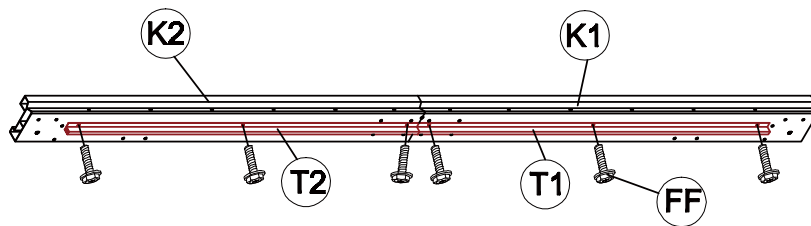
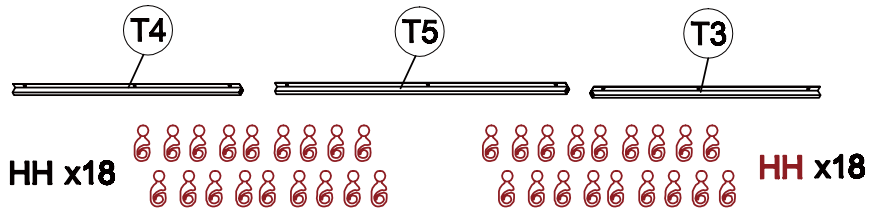
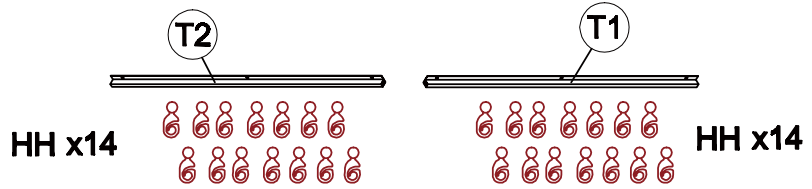

HH x128

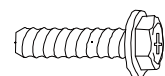

FF x30

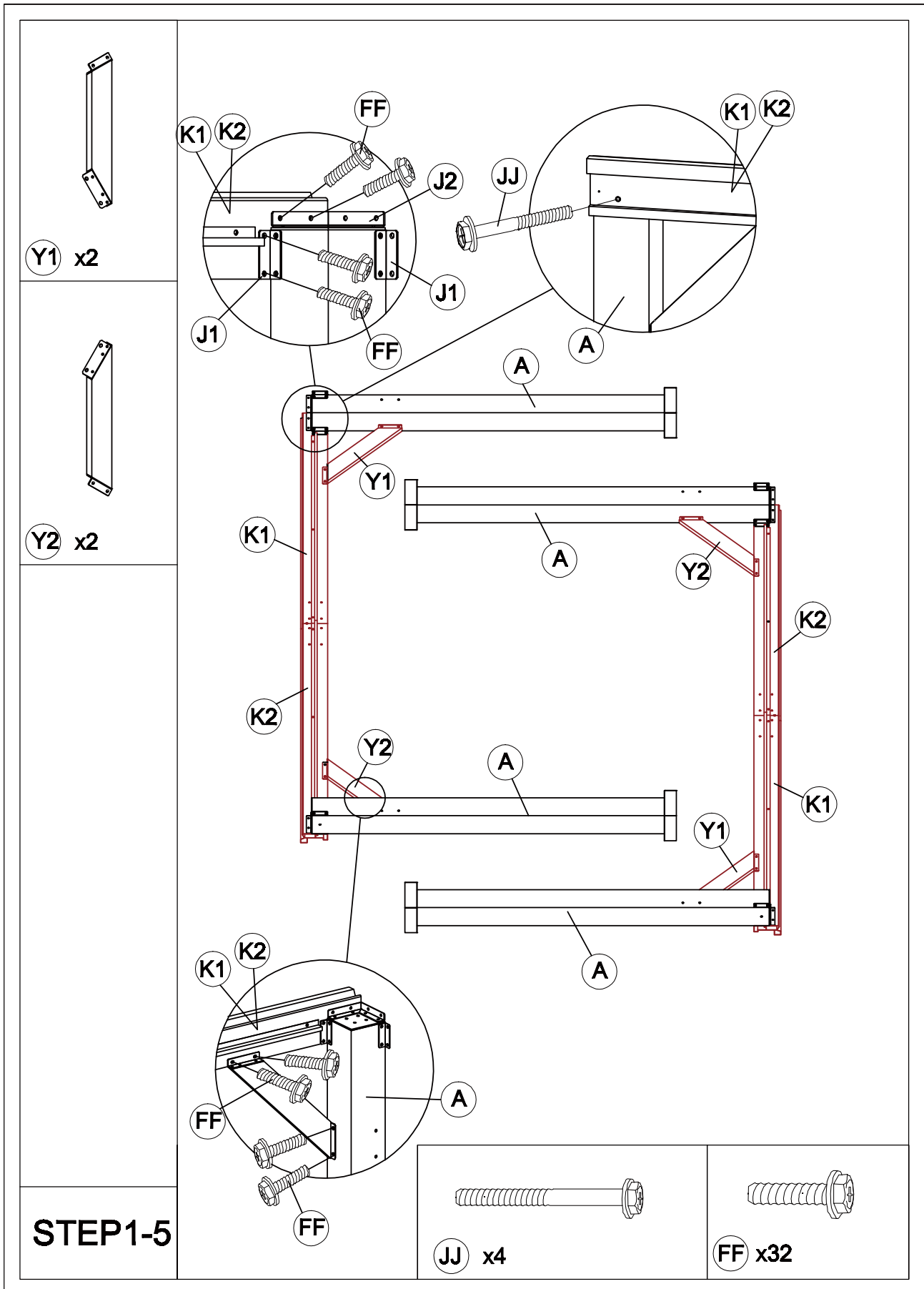



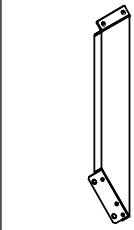

Y1 x2

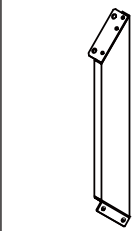

Y2 x2

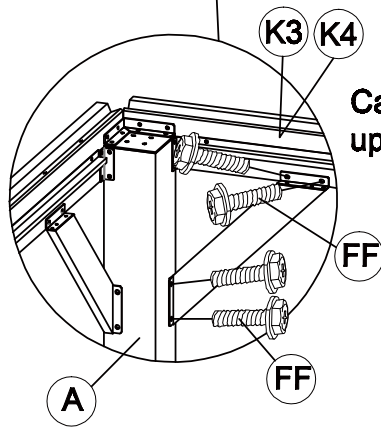
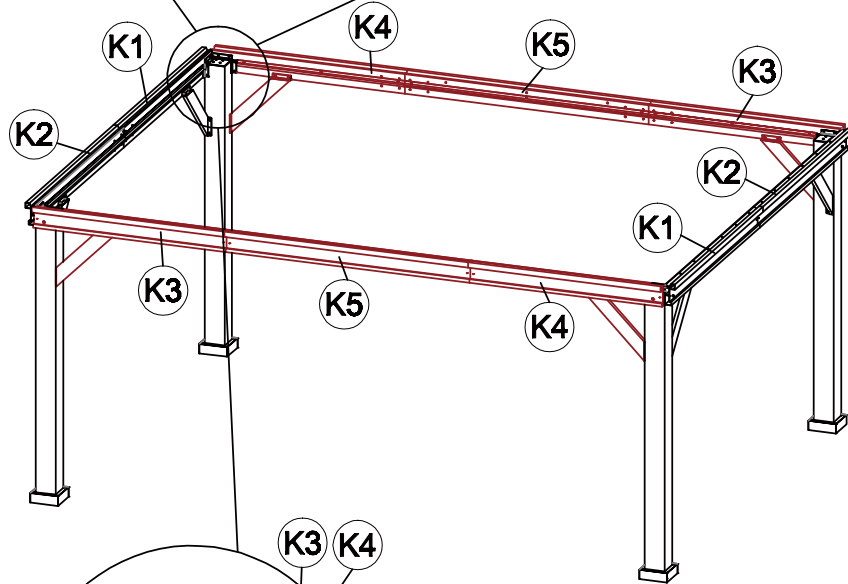
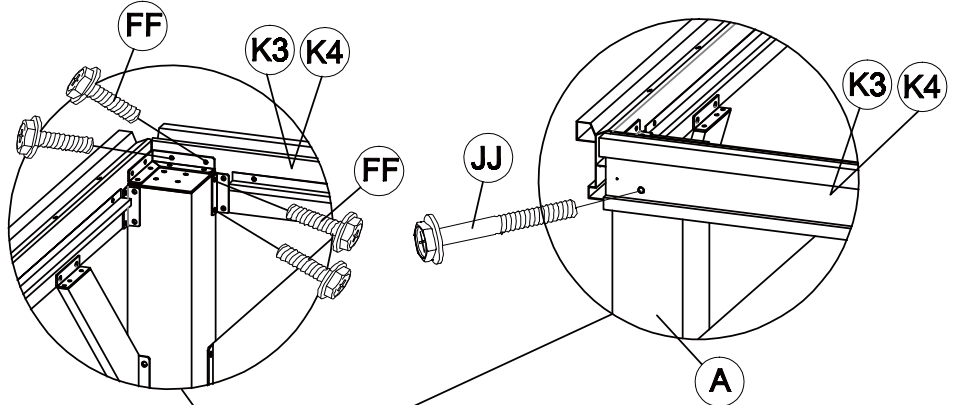

**Caution:** make sure all crossbeams are lined up properly, and installed horizontally.

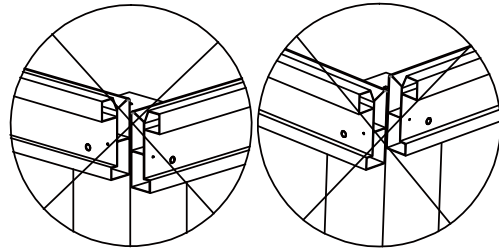

**STEP1-6**

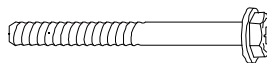

JJ x4

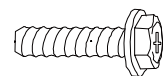

FF x32

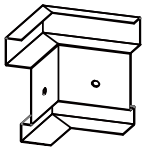

X1 x4

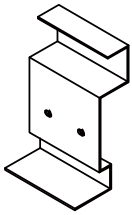

X2 x6

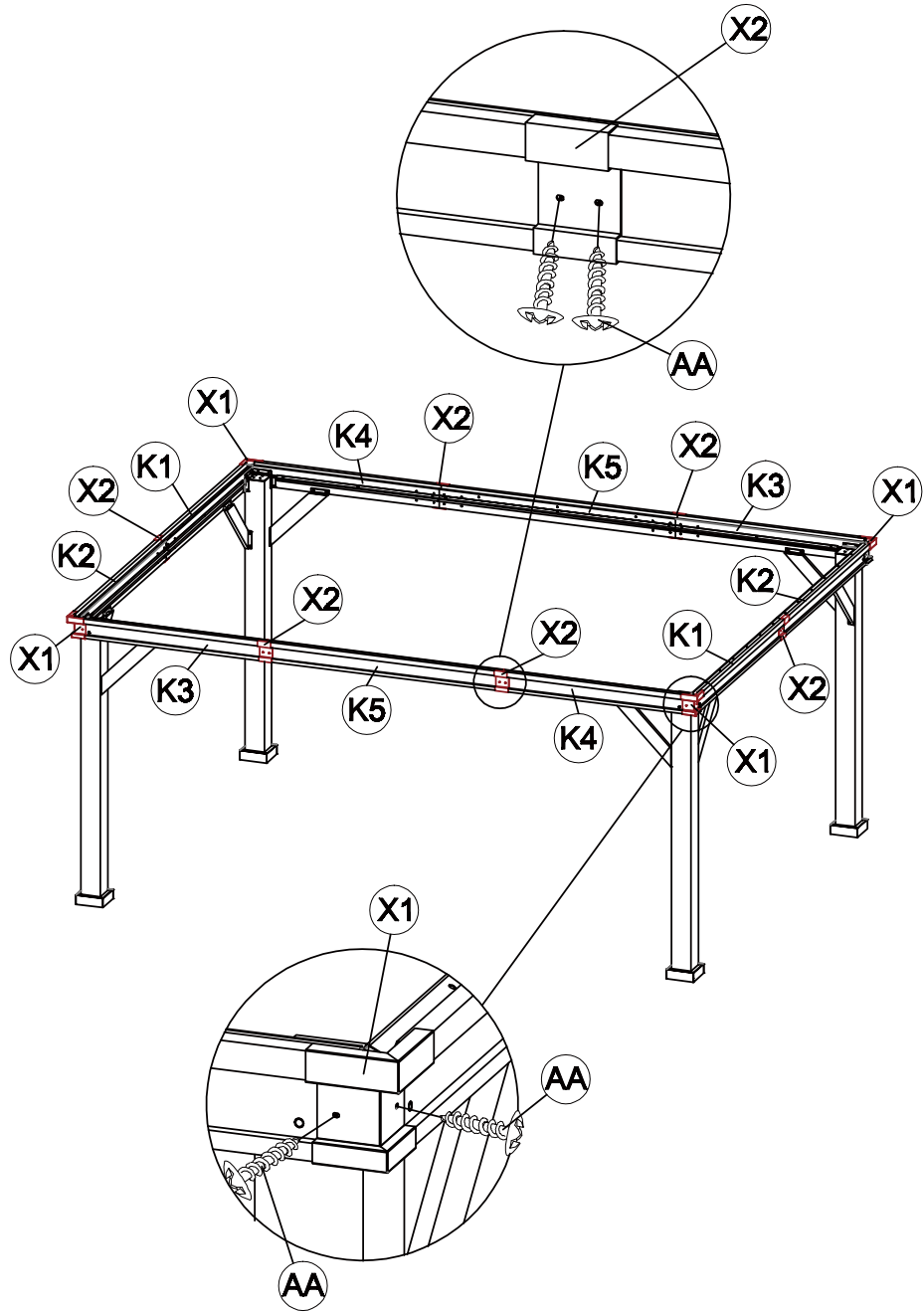

**STEP1-7**



AA x20

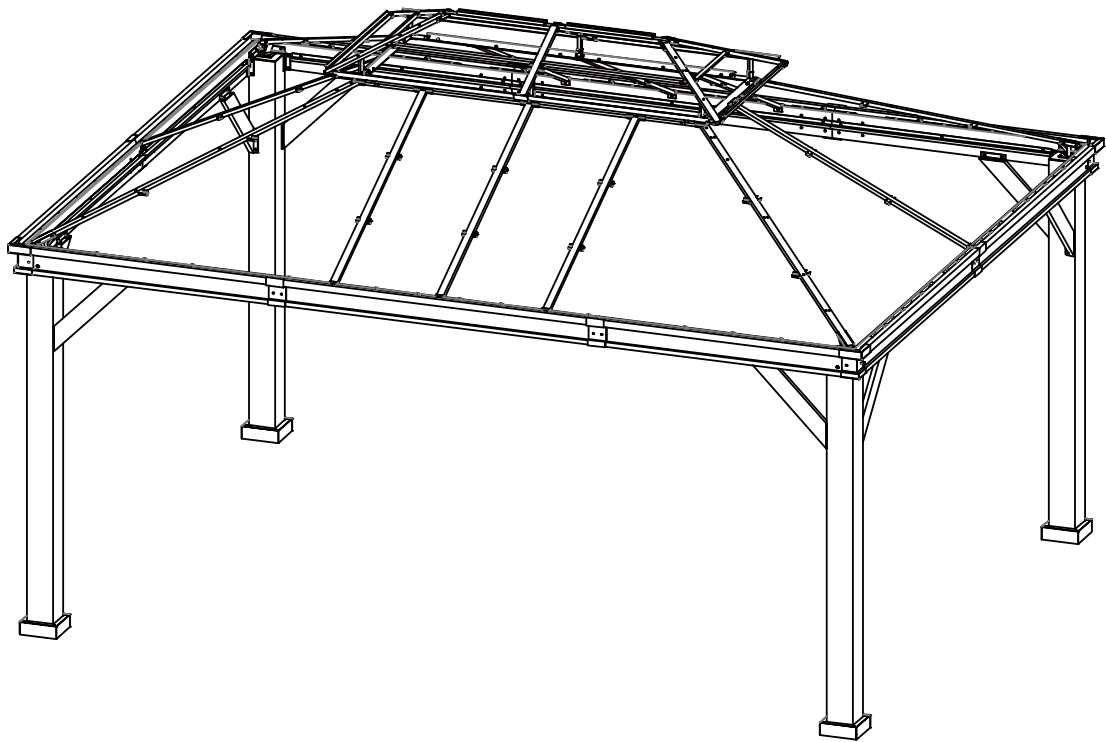

# STEP 2

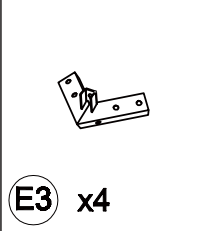
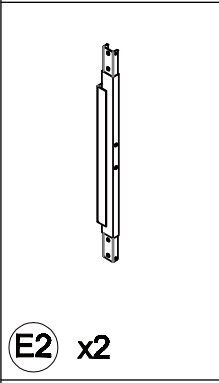
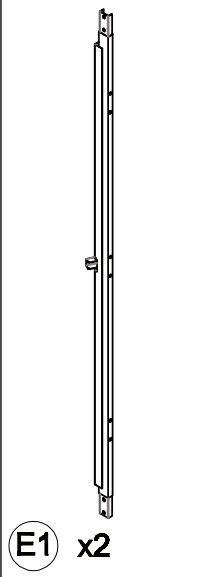

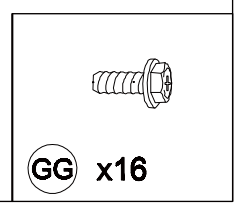
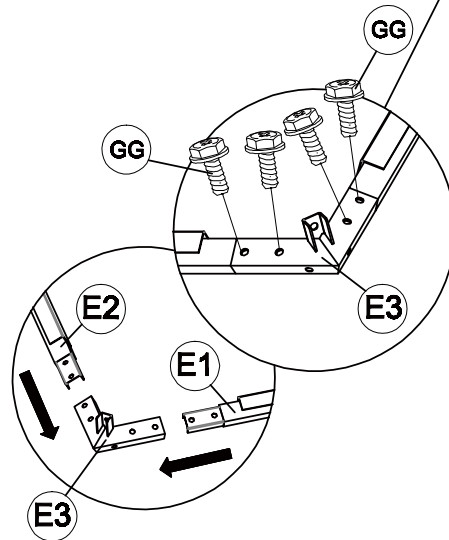
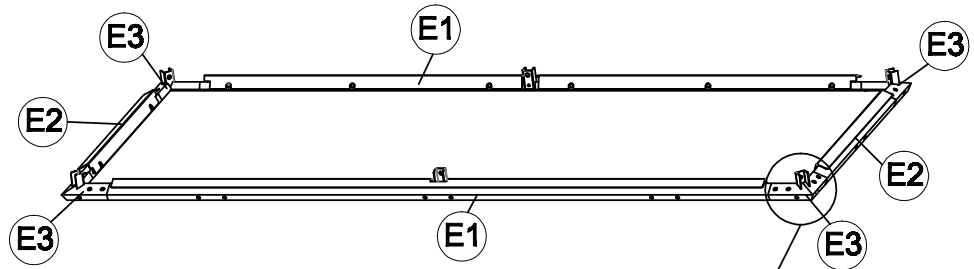

**STEP2-1**

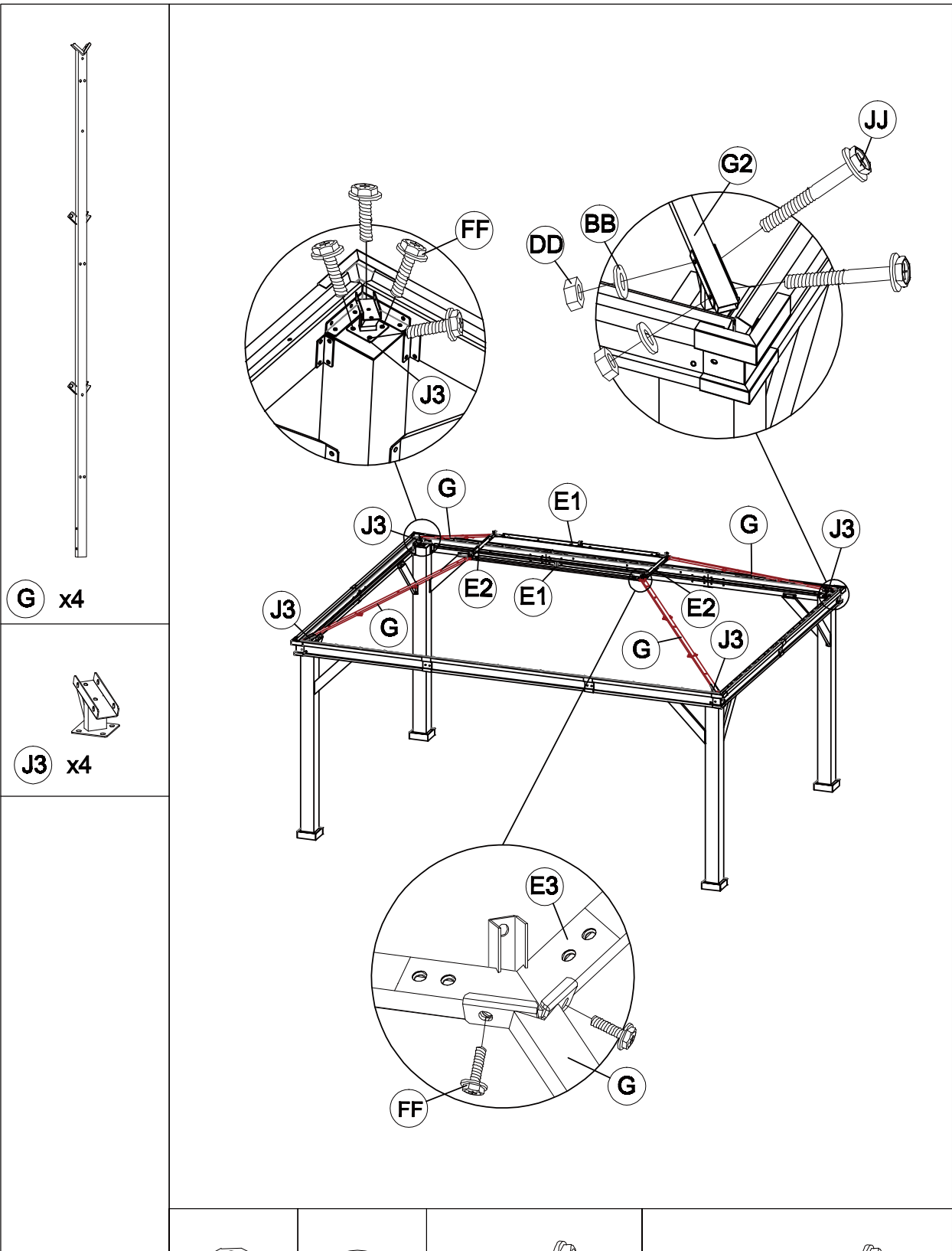



**STEP2-2**

  
**DD** x8

  
**BB** x8

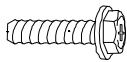
  
**FF** x24

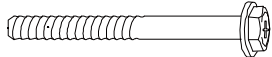
  
**JJ** x8

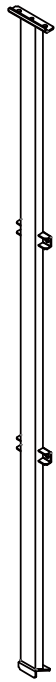

**H** x8

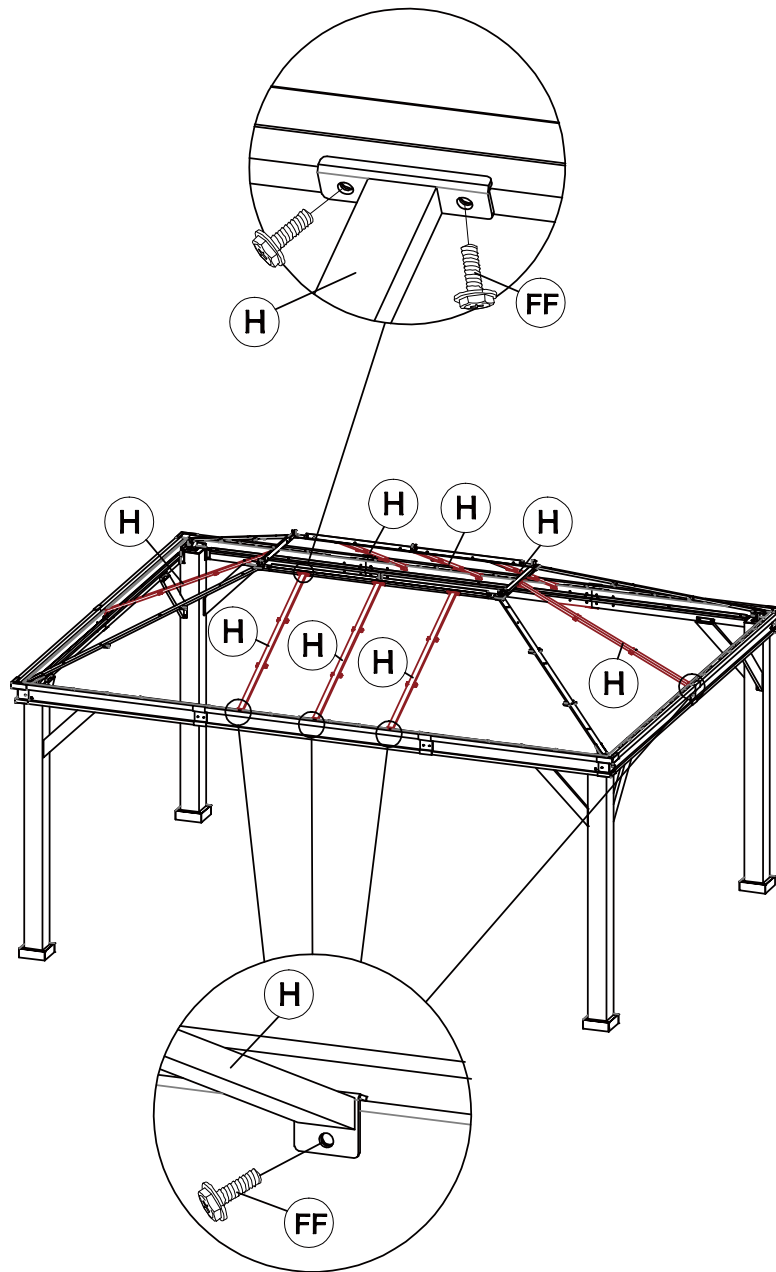

**STEP2-3**

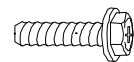

**FF** x24

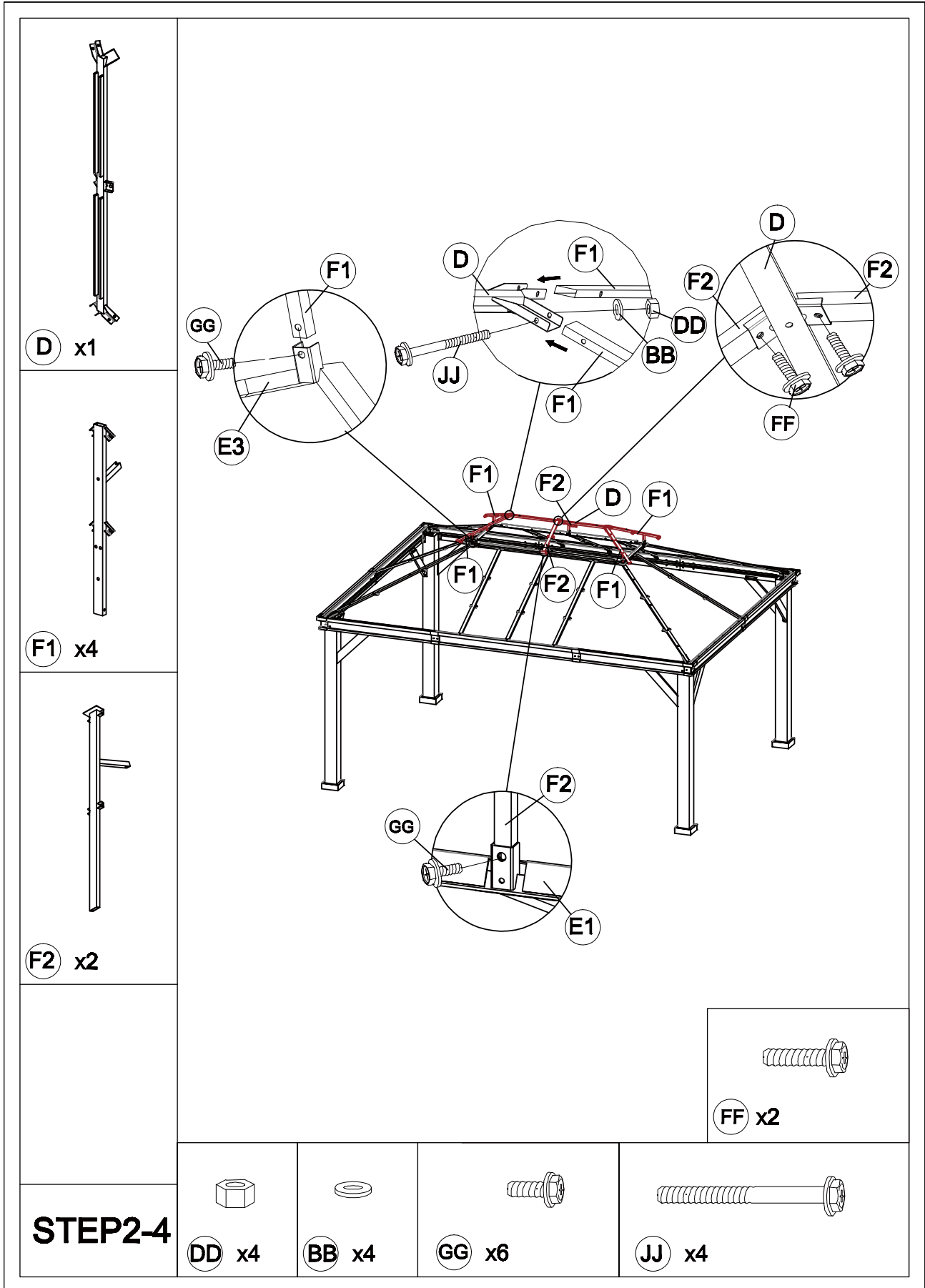

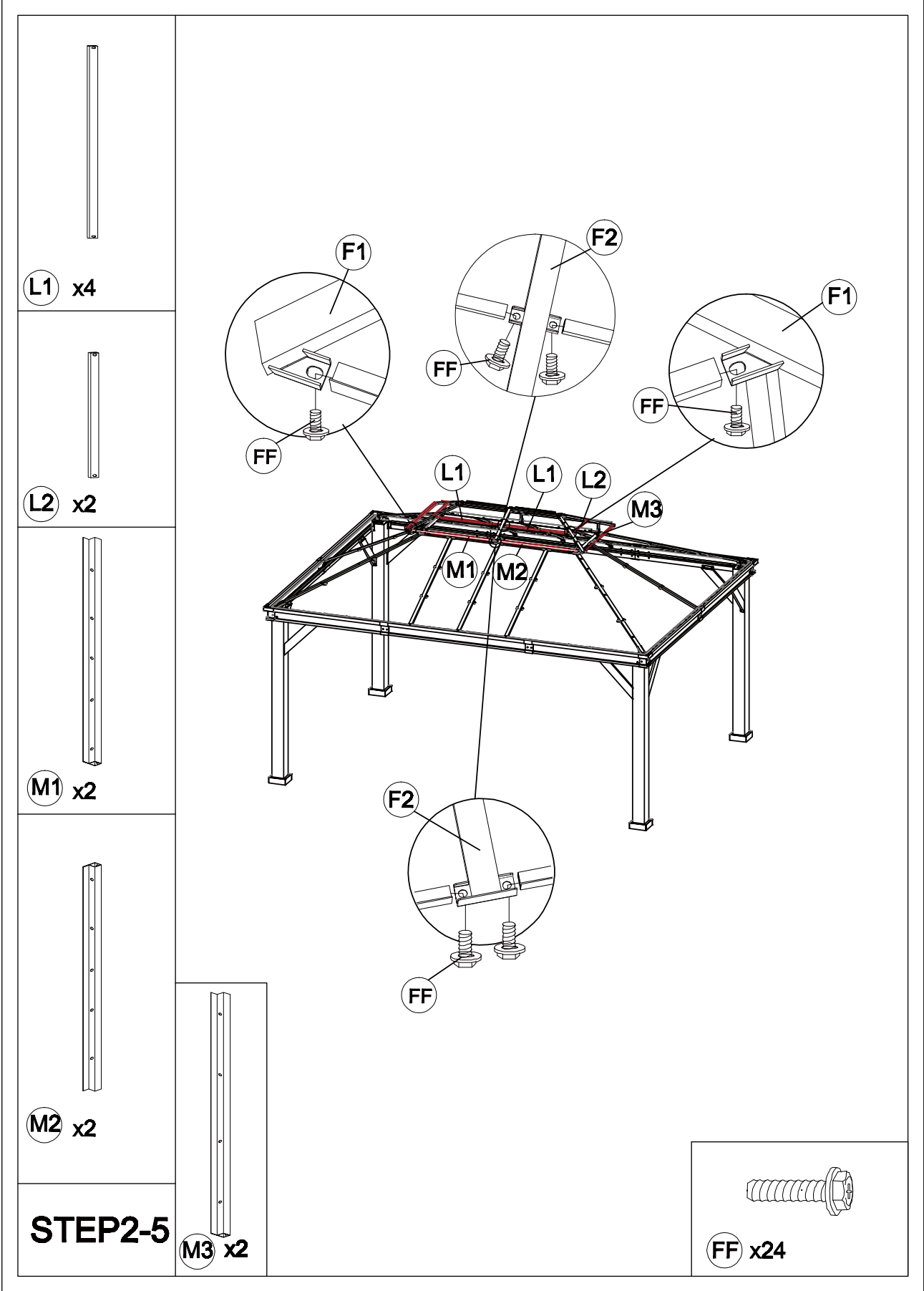



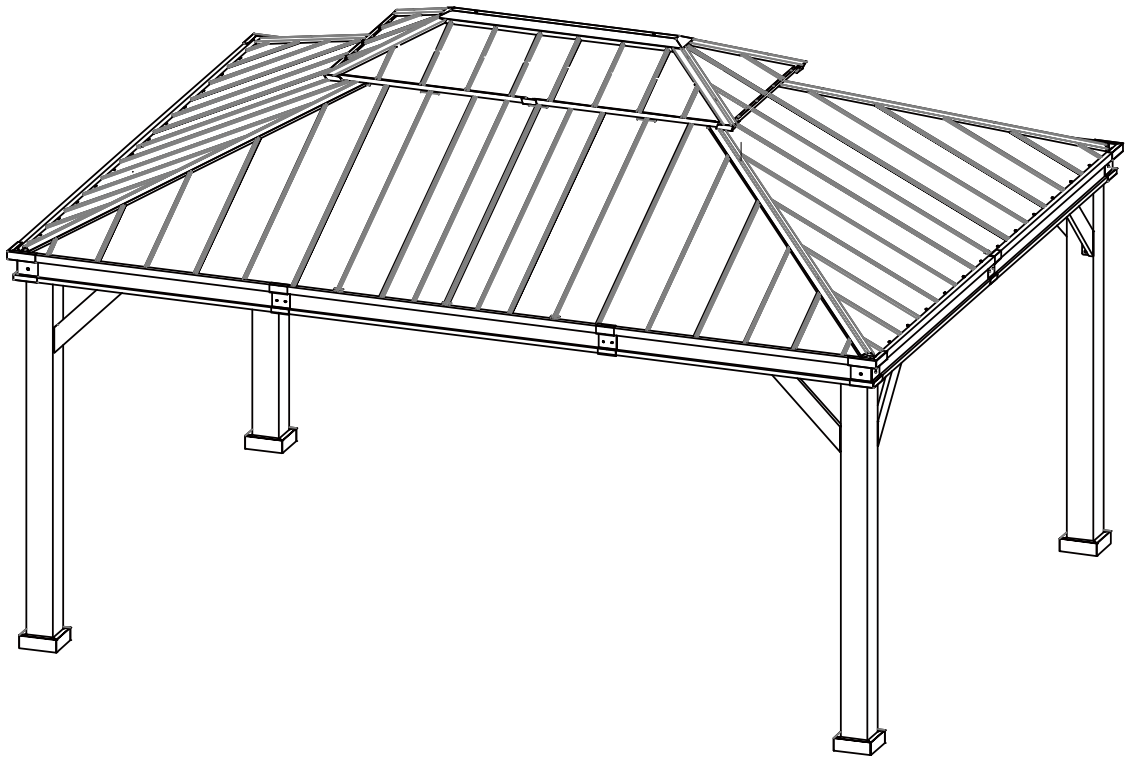

# STEP 3

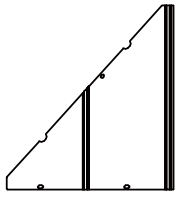

P1 x4

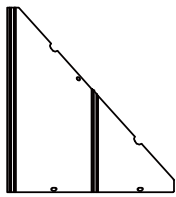

P2 x4

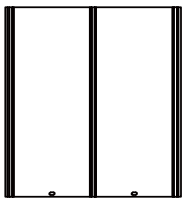

P3 x4

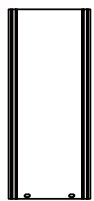

P4 x2

### STEP3-1

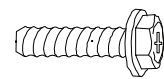
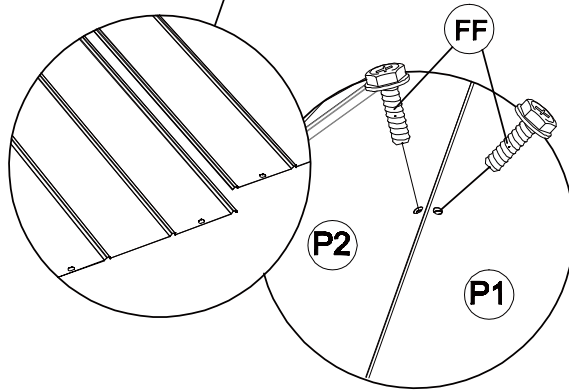
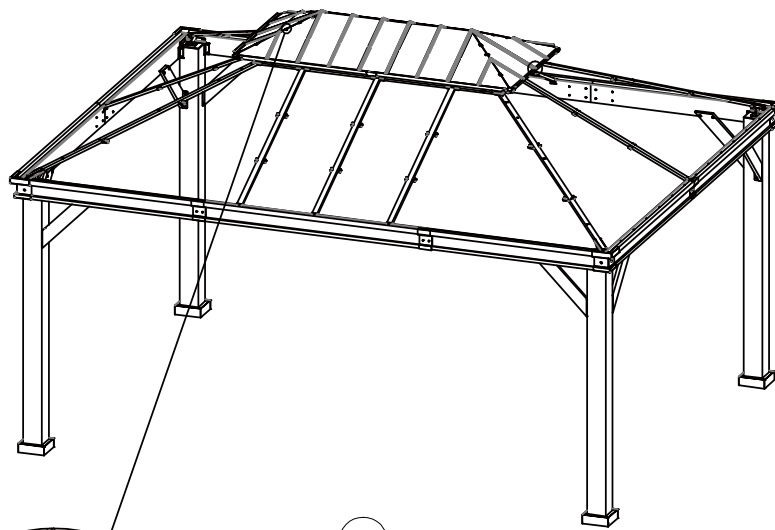
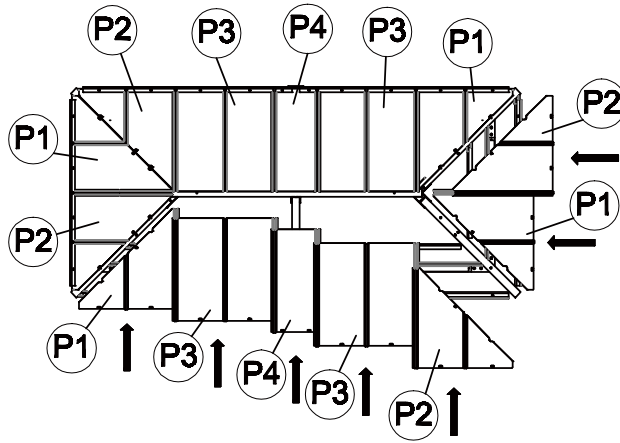

FF x8

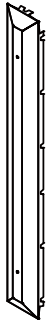

R1 x1



R2 x4



P x1

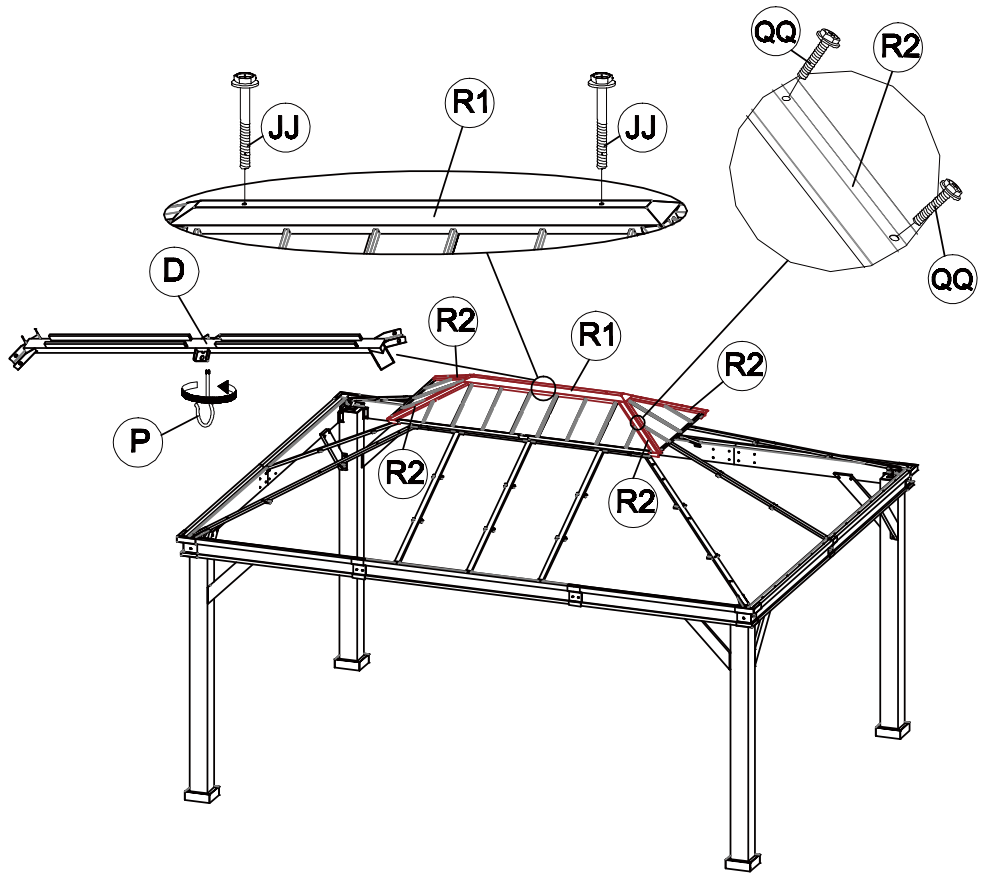

**STEP3-2**

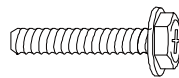

QQ x8

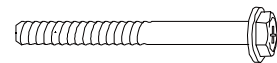

JJ x2

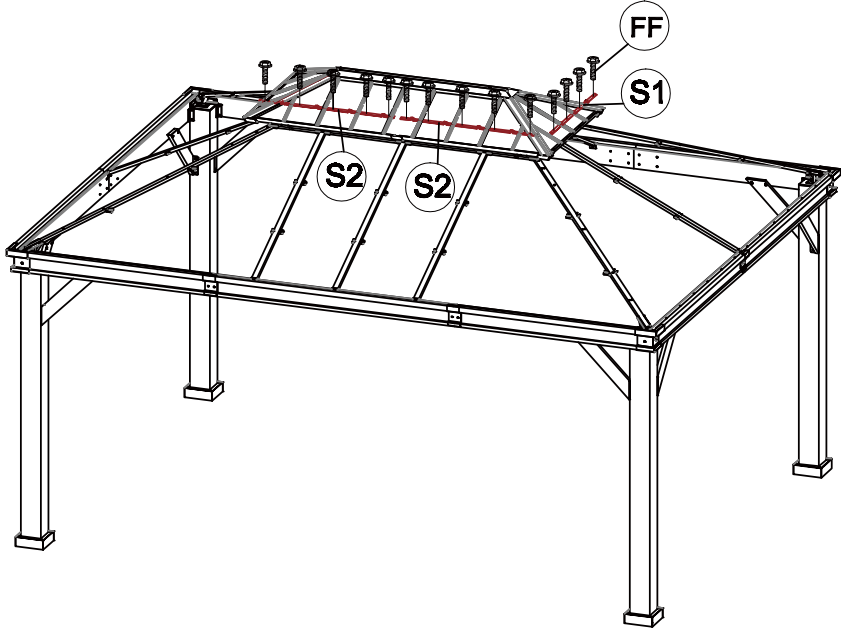
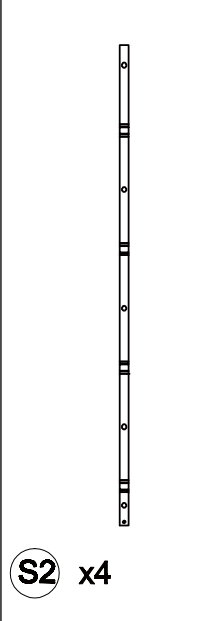
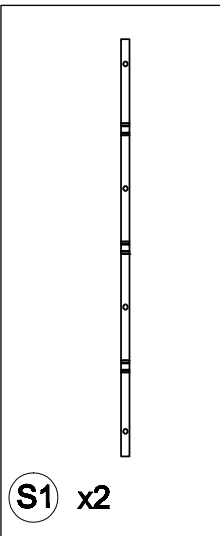

**STEP3-3**

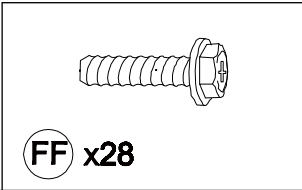

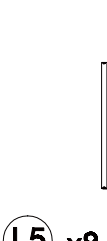
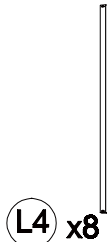

**STEP3-4**

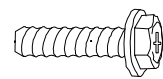
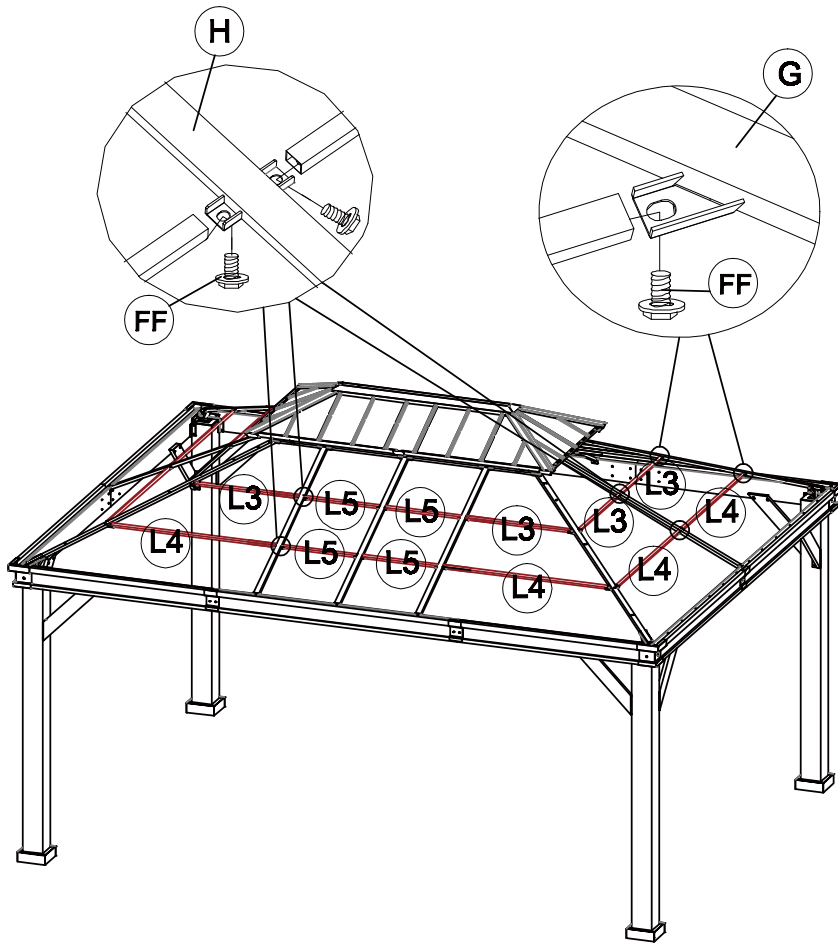

FF x48

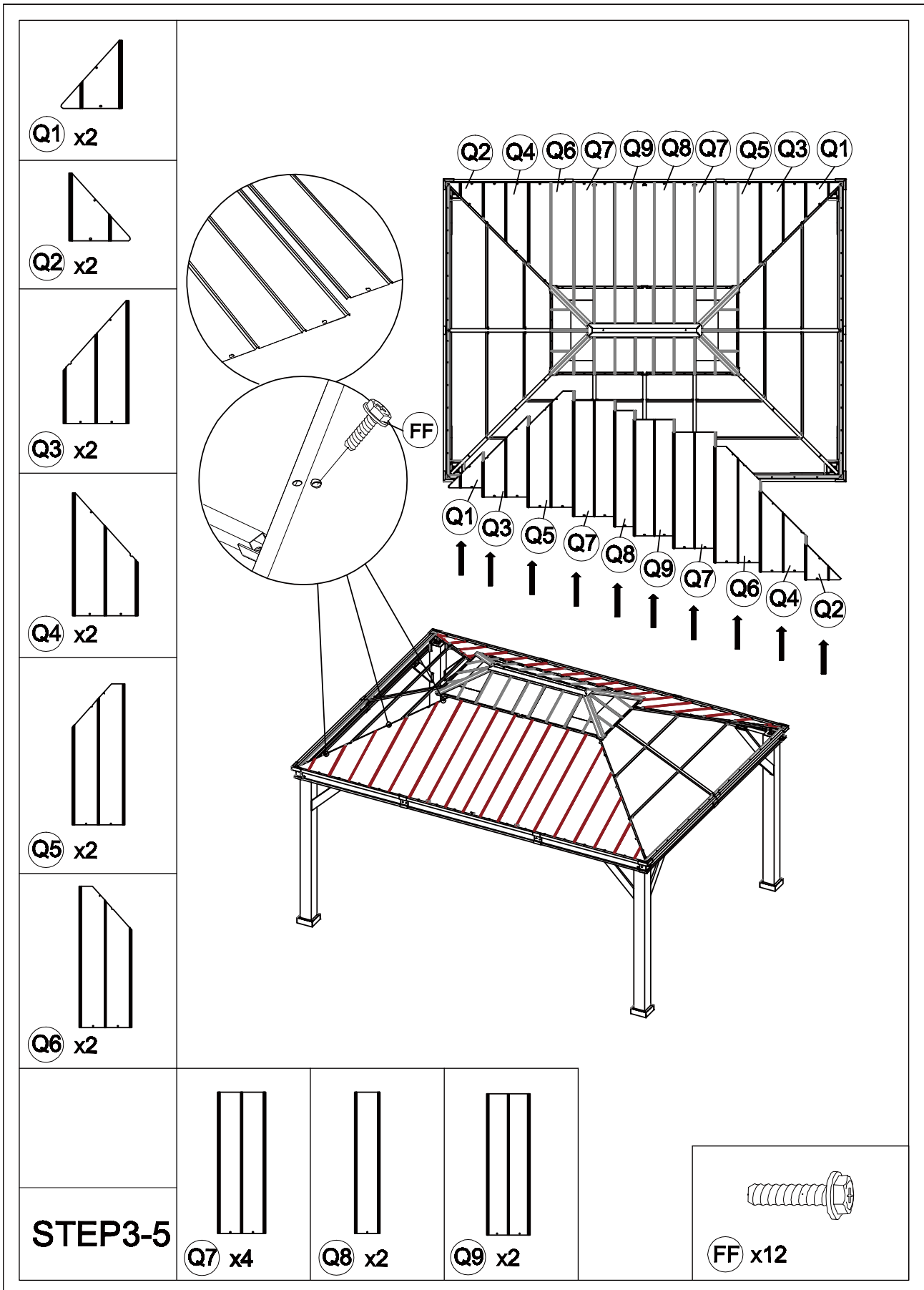

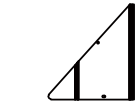

Q1 x2

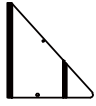

Q2 x2

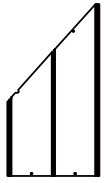

Q3 x2

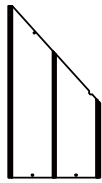

Q4 x2



Q5 x2



Q6 x2



Q7 x2

**STEP3-6**

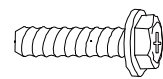
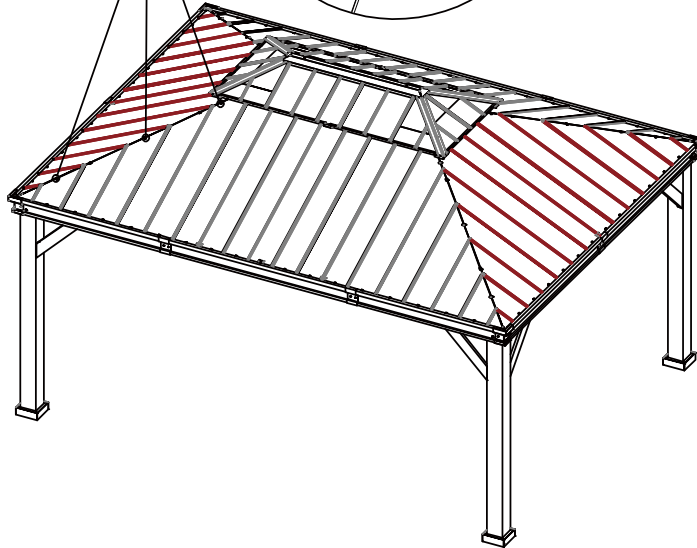
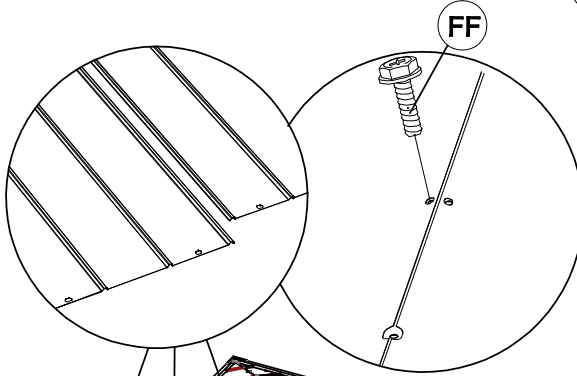
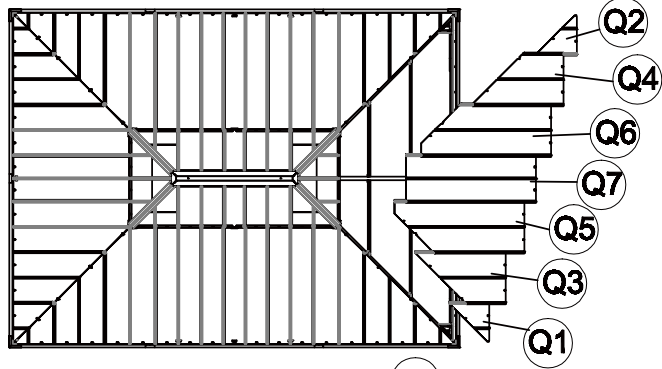

FF x12



R3 x4

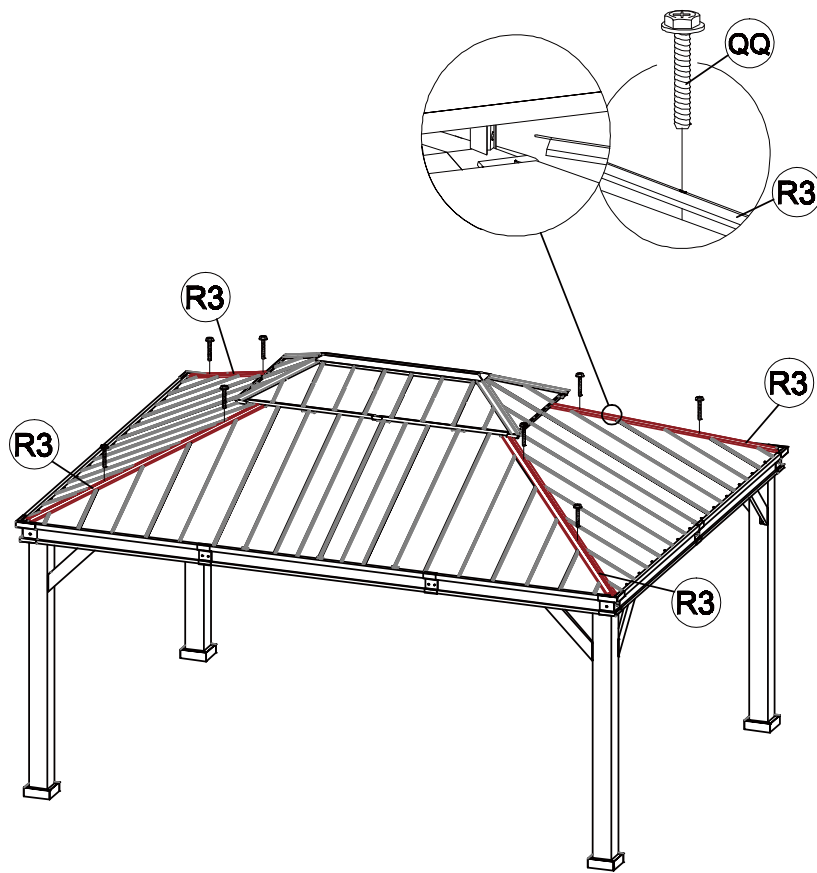

**STEP3-7**

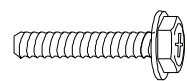

QQ x8



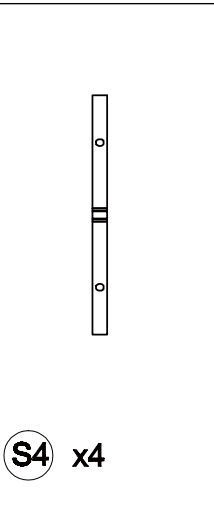
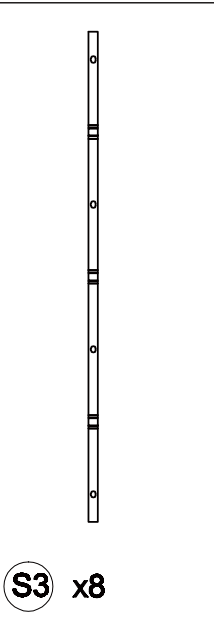
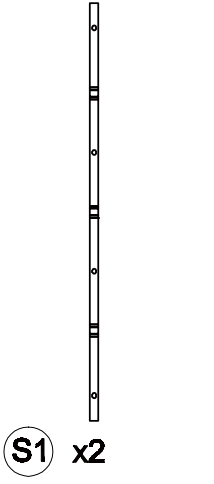

**STEP3-8**

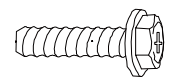
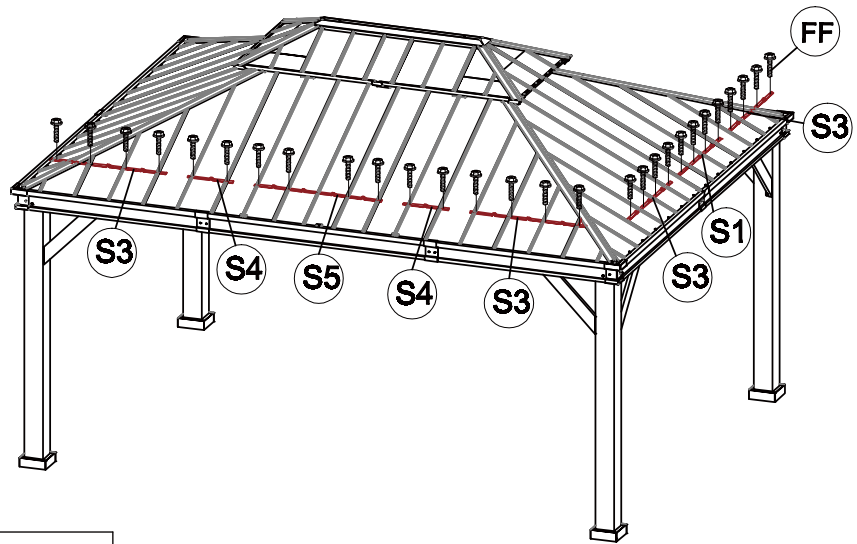
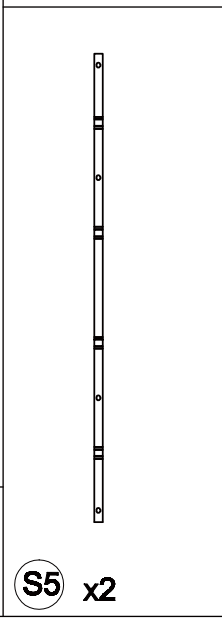

**FF** x56

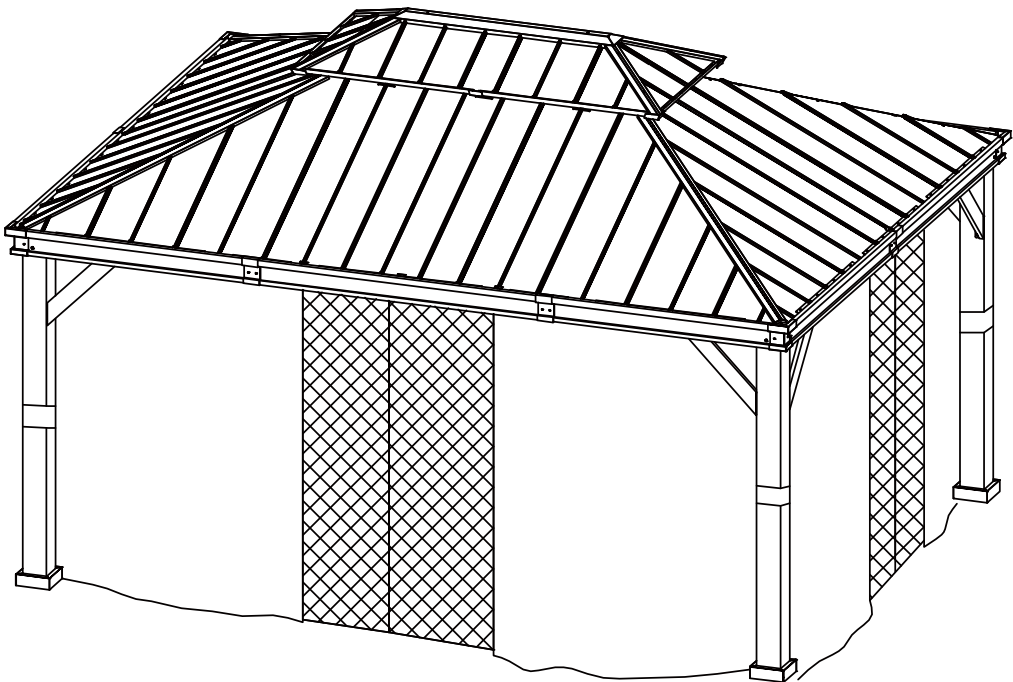

# STEP 4

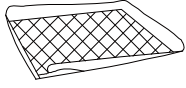

U x1

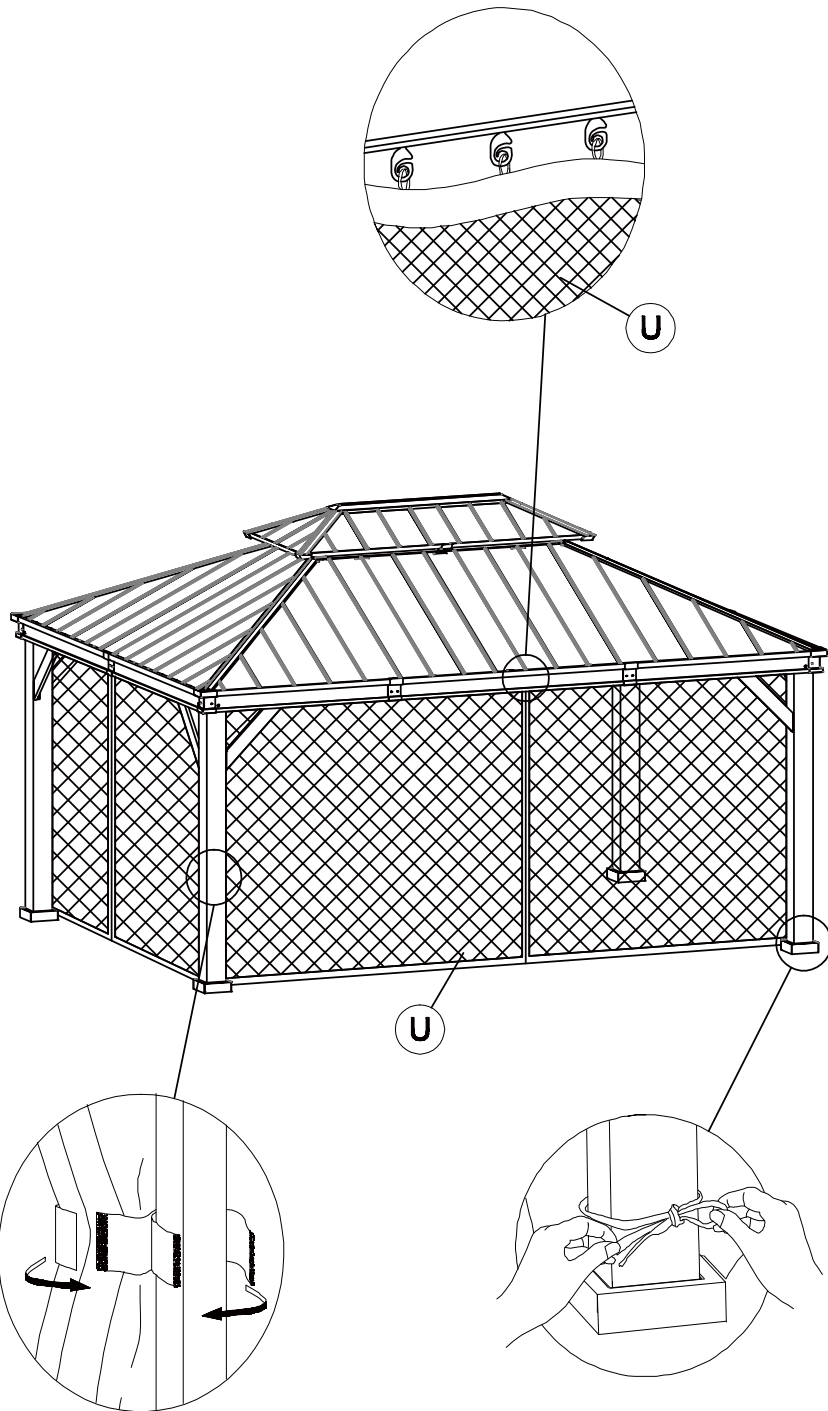

**STEP4-1**

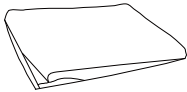

V x1

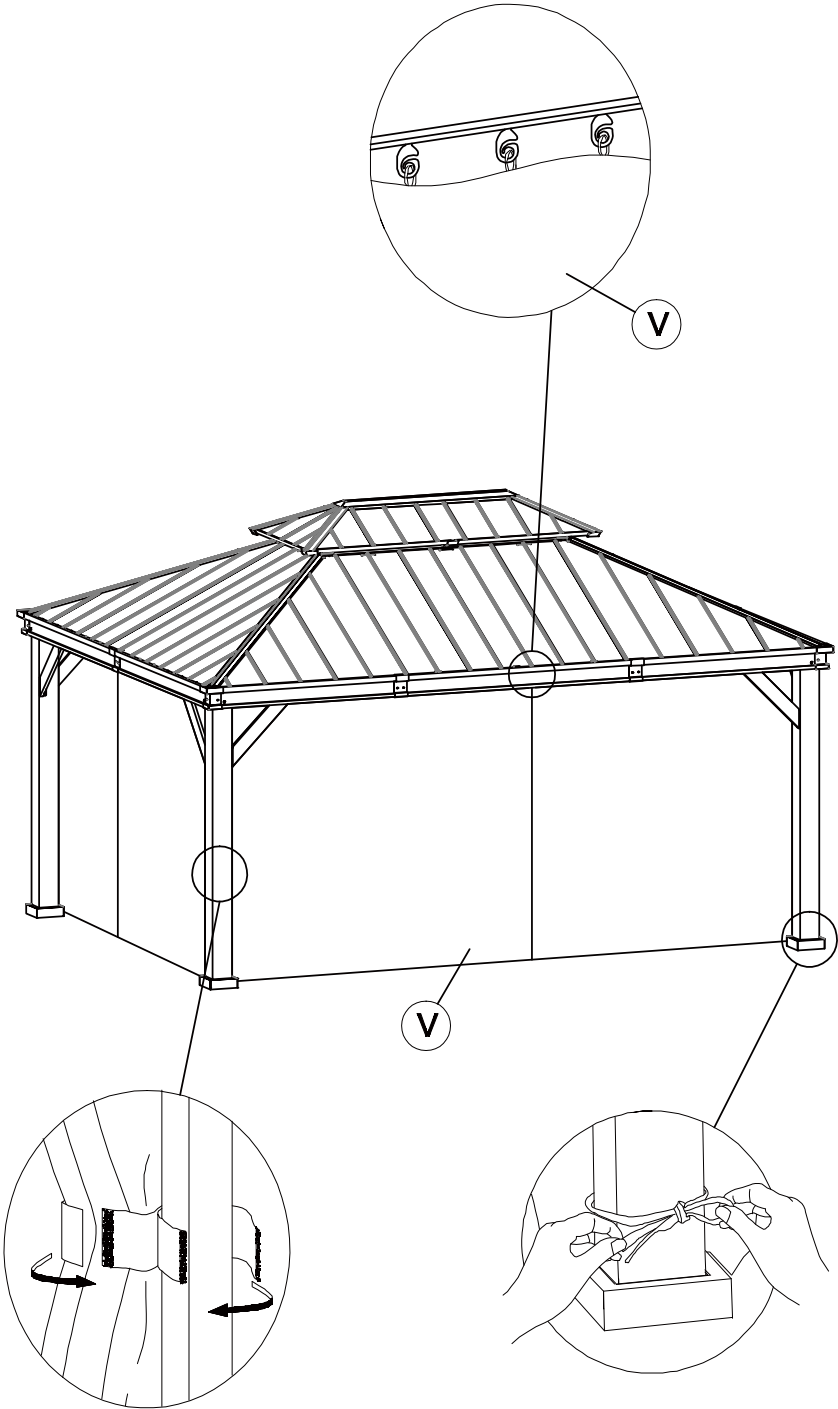

**STEP4-2**

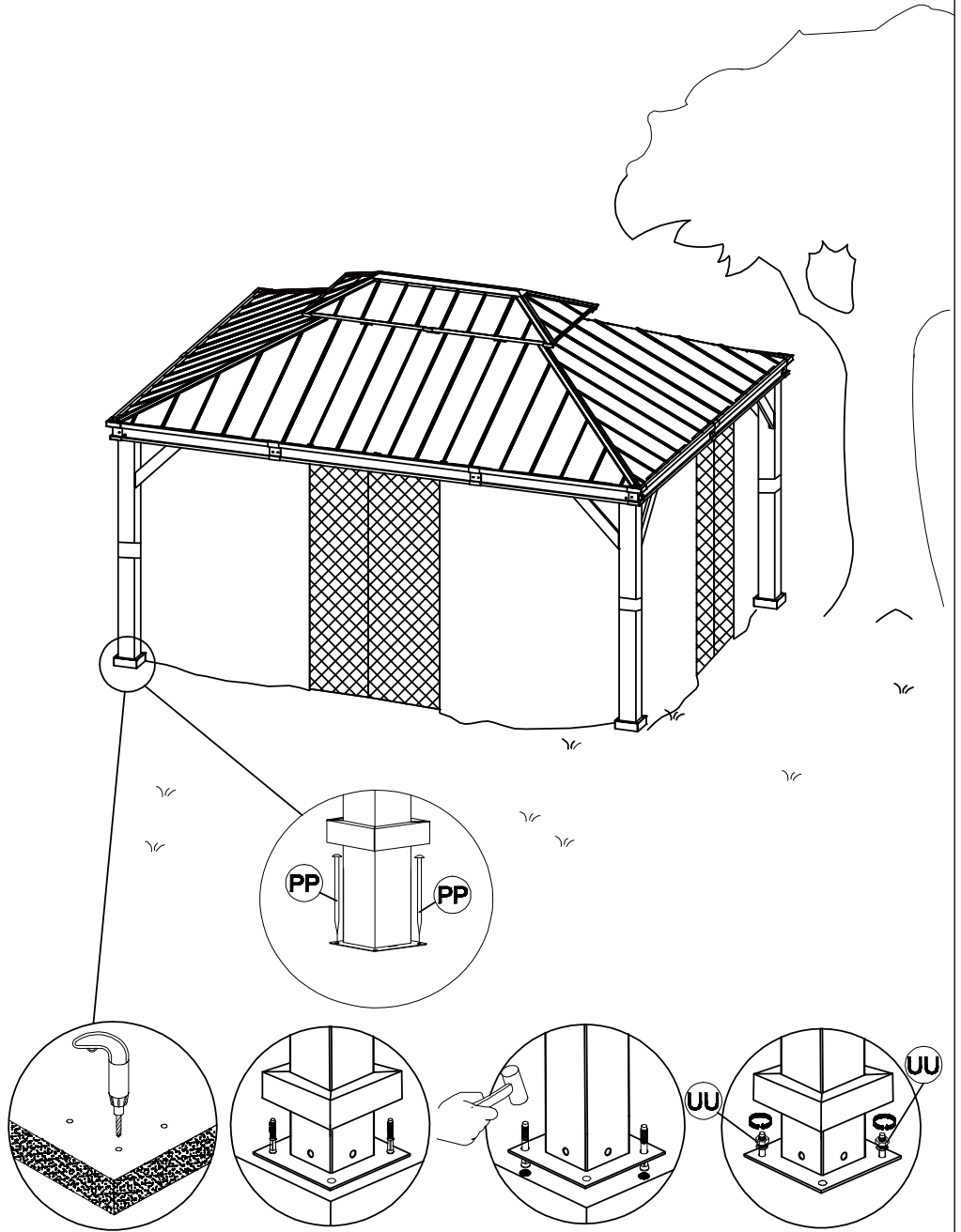

**STEP4-3**

UU x8

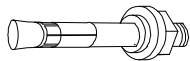

PP x8

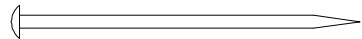

# Care and Cleaning

- Wash frame parts and fabric with mild soap and water, rinse thoroughly.
- Dry the frame completely and allow the fabric to drip dry.
- Do not use bleach, acid, or other solvents on the fabric or frame parts.
- Please inspect and tighten all bolts or fasteners on a regular basis to ensure the proper performance and safety of your gazebo.

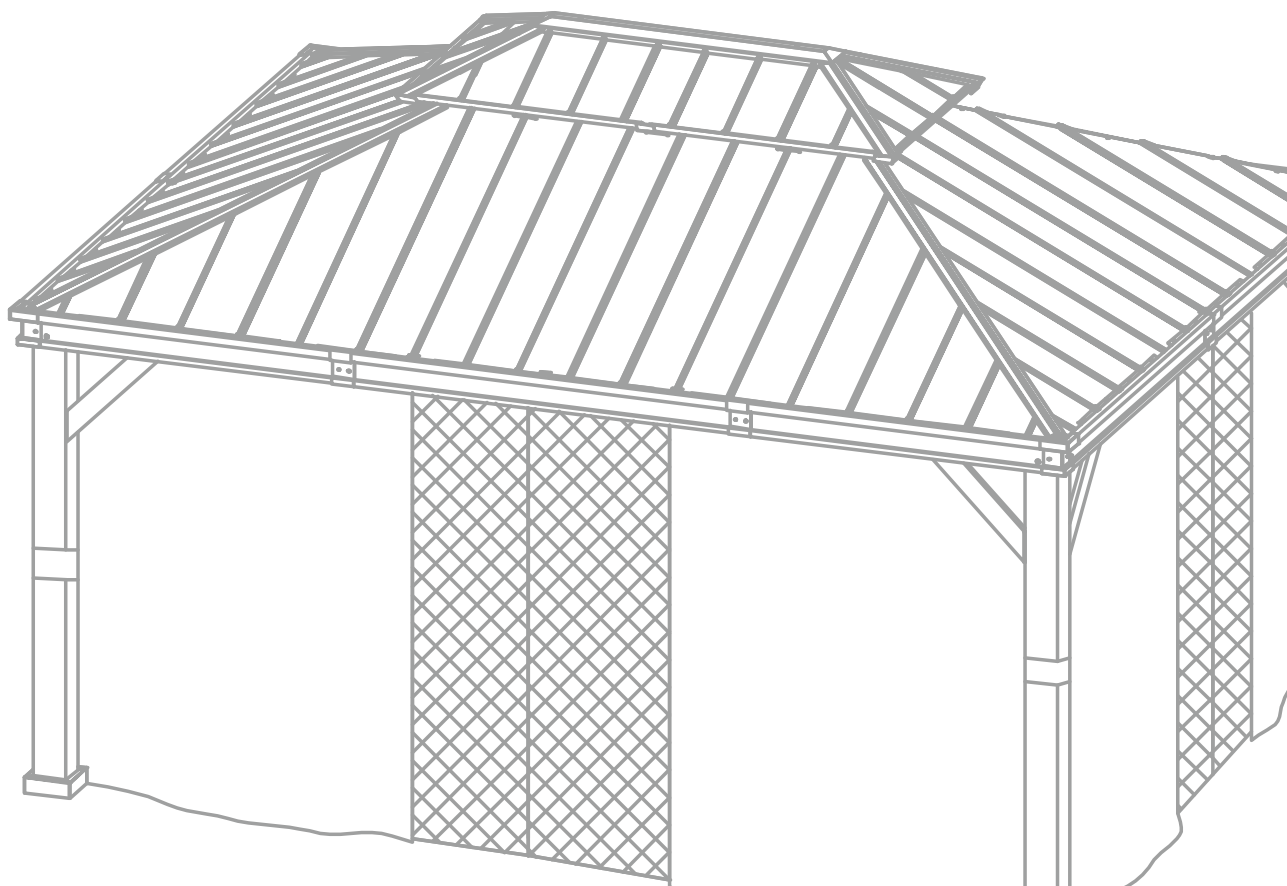

# Warranty

## One Year Warranty

### Frames

---

Frames constructions are warranted to be free from defects in material and workmanship for 1 year from item purchased. Damage to frame from negligence won't be covered by this warranty.

### Bolts & nuts

---

Bolts and nuts are warranted to be free from defects in material and workmanship for 1 year from item purchased. Damage from exposure to chemicals (including not only oils ,spills, fluids) won't be covered by this warranty.

### Curtains & Netting

---

Curtains and netting are warranted to be free from defects in material and workmanship for 1 year from item purchased. Damage from exposure to chemicals (including but not only oils, spills, fluids) won't be covered by this warranty.

### Warranty Limitation

---

This warranty is for the original purchase order only. (Order number required). This warranty is non-transferable. Olilawn is responsible for the free replacement part including shipping charges for the 1 year warranty.

### Warranty Exclusion

---

This warranty does not cover products subject to negligence, abuse usage, inappropriate installation, extreme weather condition. Olilawn reserves the right to explain warranty exclusions. When the replacement item is applied, the 1 year warranty automatically expires. Please feel free to contact us for applying warranty.



 **Website**

[www.oilawn.com](http://www.oilawn.com)

 **Contact**

[support@oilawn.com](mailto:support@oilawn.com)

 **Address**

Room 1003, No.209, Baoyuan Road, Baoan District, Shenzhen

 **Copyright**

Copyright © Shenzhen Xinfeng Innovation Technology Co., Limited

