

# LeCavist

User guide

Wine Fridge

LKS105VX2Z



**IMPORTANT SAFETY WARNINGS AND ADVICE**

**Please read this user guide carefully and in full before installing and using the wine fridge.**





It is important that this guide is kept with the fridge for future reference.

If the wine fridge is given to another person, make sure the user guide follows the fridge so that the new owner can properly install and use the fridge.



Please recycle. At the end of the product's life, consider bringing it to a collection point or drop it off at a recycling centre near your home.

The meaning of these symbols in this user guide is outlined below.

	Important information about your personal safety and how to avoid damaging the fridge.
	General information and advice
	Environmental information
	Fire risk
	Risk of electric shock

## GENERAL SAFETY



For your safety and the safety of others, please read these safety instructions carefully before installing and using your wine fridge.

- This fridge is intended for domestic use or in similar settings such as:
  - kitchen areas in an office or other business environments; and
  - hotels (for guest use), motels and other residential environments.
- This wine fridge should not be used for commercial or industrial purposes or for any purpose other than the one for which it was designed. This fridge is intended for wine storage.
- Do not use outdoors.
- Make sure the voltage on the product matches your power supply before plugging it in.
- Check the condition of your fridge regularly. Do not use the device if it is damaged.

- Always unplug the fridge at the power socket before cleaning the unit; defrosting it; changing the lighting lamp (when it is replaceable); moving the fridge or cleaning the ground under the fridge.
- Do not remove the electrical socket by pulling on the cord. To remove it, hold the plug and carefully remove it from the wall socket.

**WARNING:** Do not dismantle or otherwise damage the refrigeration system.

**WARNING:** Fire hazard. Contains refrigerant gas.



- The refrigerant gas contained in this device is isobutane (R600a). It is a flammable gas. When transporting and installing the unit, be careful not to damage any part of the refrigeration system.
- Do not use anything sharp to defrost the device.
- Do not use any electrical appliance inside the wine fridge.
- If the refrigeration system is damaged:
  - Do not use a flame near the device.
  - Avoid sparks - do not turn on an electrical appliance or electric lamp.
  - Immediately ventilate the room.

**For your safety, follow these installation recommendations:**

The room in which the fridge will be installed must be at least 1m<sup>3</sup> per 8 grams of refrigerant gas. The amount of refrigerant gas contained in this fridge is shown in grams on the rating label at the back of the fridge.

## CHILD SAFETY



This fridge may be used by children aged 8 years or older and by persons with reduced physical, sensory or mental abilities or lack of experience or knowledge, if they are properly monitored, or if instructions on the safe use of the fridge have been given and if the risks involved have been appropriately assessed.

The fridge is not a toy. Children should be monitored to ensure proper use of the fridge.

Cleaning and maintenance should not be done by children without supervision.

## CONNECTION

- Check the plug and power cord regularly for damage.
- Do not use the device if the power cord or socket is damaged.



**WARNING:** If the power cord is damaged, it must be replaced by the manufacturer, its after-sales service or people of similar qualification to avoid danger.



## ELECTRICAL SAFETY

- Do not connect the fridge to a power outlet that is not protected from overloads.
- Never use power boards with multiple sockets to connect the device.

**WARNING:** Do not immerse the cord in water, handle the electrical components or grip them with wet hands.

- The power socket to which the wine fridge is connected must be easily accessible, so it can be disconnected quickly in an emergency.
- Do not unplug the fridge by pulling on the cord and do not wrap the cord around the fridge.
- Turn the fridge off before unplugging the power cord from the socket.
- Always unplug the fridge before cleaning it.
- In the event of a fire, unplug the power cord if safe to do so or separate the unit from the area by another means before taking fire action.
- This fridge is not intended to be activated by an external timer, by a separate remote-control system or any other device that automatically switches on the device.
- If you do not use the device for a long period of time, please turn it off and unplug it from the power supply.
- Do not store explosive materials such as aerosol containers with a flammable thruster in this device.
- Any maintenance or repair of this device must be carried out by a licensed professional. Do not attempt to repair the device yourself.



**WARNING:** Danger of Electrocutation

**WARNING:** The ventilation openings on the fridge's casing must remain uncovered. Be careful not to block them.

**WARNING:** Do not use mechanical devices inside the wine fridge.

**WARNING:** Do not dismantle or otherwise damage the refrigeration system.

**WARNING:** Do not use electrical appliances in the wine fridge, other than those recommended by the manufacturer.

## INSTALLATION

- This wine fridge is heavy. Be careful when moving it.
- When transporting the fridge, be careful not to damage any part of the refrigeration system.
- Important! Leave your device vertical for 24 hours before plugging it in for the first time so the refrigerant gas can equalise.
- If your device has been horizontal during transport, wait 48 hours before turning it on.
- After installation, make sure the fridge is not resting on the power cable.

## CLEANING

- Never clean the appliance with flammable products. The fumes could cause a fire or explosion.
- When it comes to the use, handling, cleaning and disposal of the device, refer to the following chapters of the user guide.

**WARNING:** Do not use electrical appliances to clean your wine cellar.



## Summary

IMPORTANT SECURITY WARNINGS	Page 1
I DESCRIPTION OF THE APPLIANCE	Page 10
II TECHNICAL CHARACTERISTICS	Page 11
III INSTALLATION	Page 13
A. Location	Page 14
B. Unpacking the device and discarding the packaging items	Page 14
C. Foot adjustment	Page 15
D. Before loading the fridge	Page 15
E. Ambient temperature	Page 15
F. Changing the orientation of the door	Page 16
IV BEFORE USE	Page 18
V USING THE FRIDGE	Page 19
A. Loading your wine fridge	Page 19
B. Loading plan	Page 20
C. Adjustable shelves	Page 21
D. Functions and temperature setting	Page 23
E. Wine service temperature table	Page 25
F. Power outage	Page 26
VI MAINTENANCE AND CLEANING	Page 27
VII TROUBLESHOOTING	Page 29
VIII WARRANTY	Page 31
IX CAUTION	Page 32

This user guide is available in the following languages:

FRENCH (original version)

Other versions are a translation of the original. For an electronic version of the user guide, including the French version, visit [www.triomphe-australia.com](http://www.triomphe-australia.com).

## I DESCRIPTION OF THE DEVICE

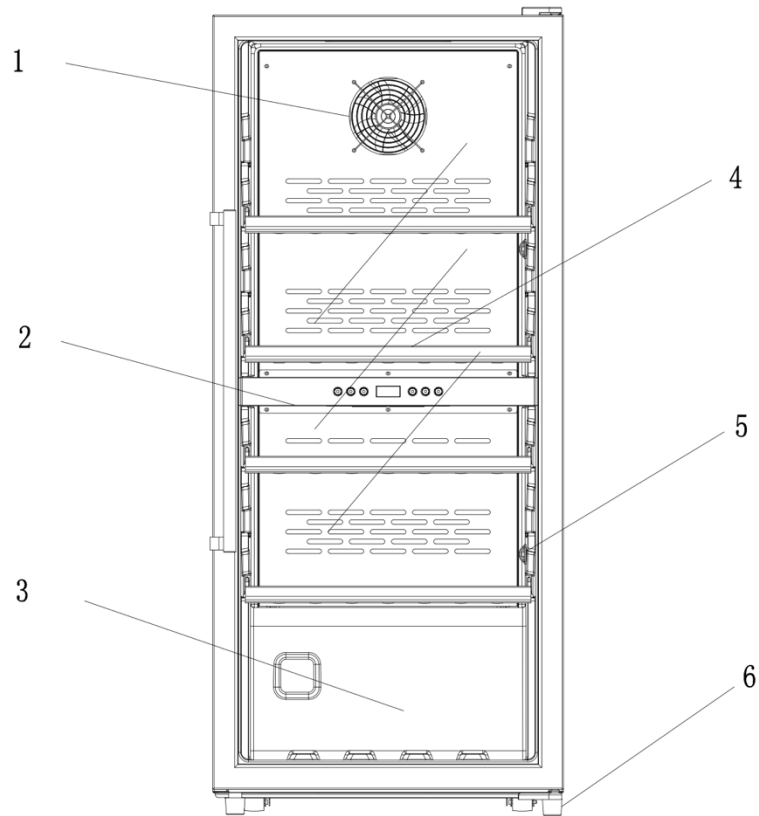

1. Fan
2. Digital control panel & display
3. UV glass door
4. Metal shelves with wooden trim
5. Temperature sensors
6. Adjustable foot

## II TECHNICAL CHARACTERISTICS

<b>Reference</b>	TKS105VN2Z
<b>Model</b>	JC-205
<b>Power supply</b>	220-240 V
<b>Electric current</b>	2.0A
<b>Power of the lamp</b>	2W
<b>Dimensions L x D x H</b>	540 x 601 x 1674 mm
<b>Net weight</b>	44 kg
<b>Type of installation</b>	Free standing
<b>Door orientation</b>	Right (factory setting)

### Electrical scheme

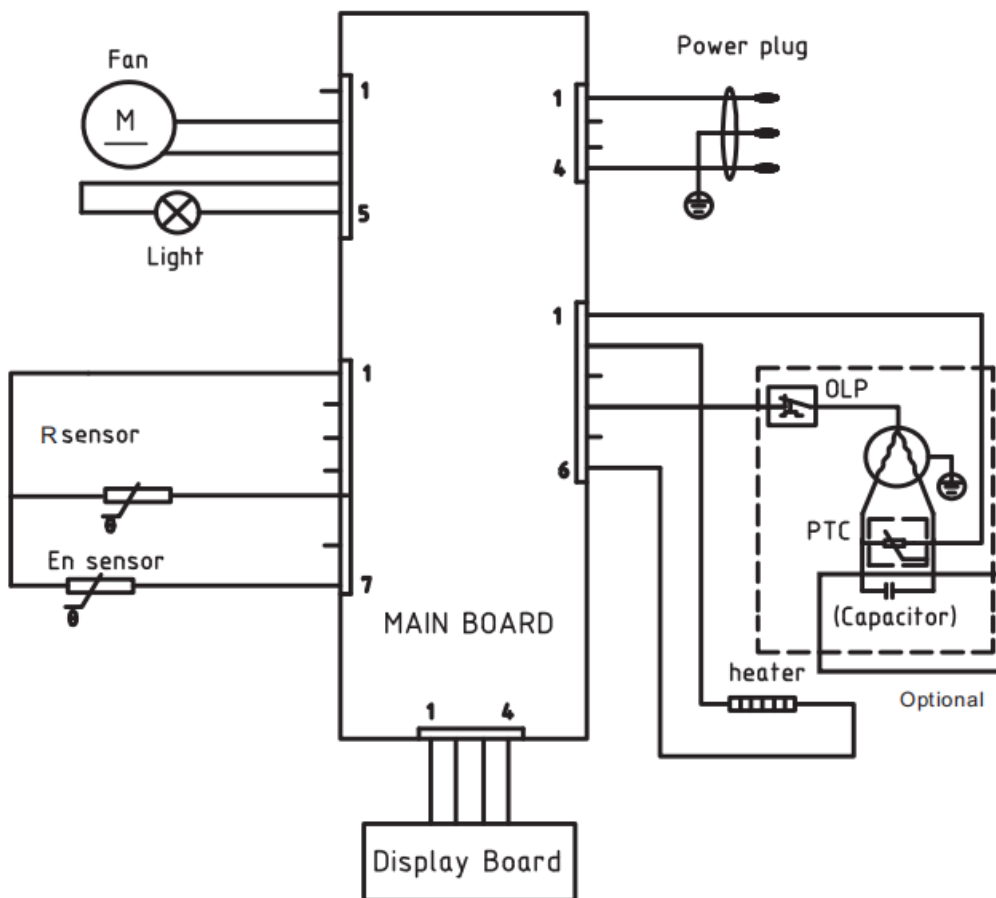

<b>ENERGY-RELATED PRODUCT SHEET</b>	
Brand	TRIOMPH
Reference	TKS105VN2Z
Volume	205L
The coldest storage temperature setting that can be maintained continuously	5°C
Defrost	Automatic
Climate class	Climate class N/ST. This fridge is intended to be used in ambient temperatures of 16-38°C.
Noise (dB)	45
Integrable device	No
<b>This device is intended only for the storage of wine</b>	

### III INSTALLATION

#### **Recommendations:**

The location you have selected for your wine fridge should:

- be well ventilated
- be away from any source of heat and direct sunlight;
- not be frequently wet (e.g. laundry, bathroom);
- have a level floor;
- have a reliable electricity supply; and
- be away from the microwave. Some microwaves do not have a wave jamming shield so when the wine fridge is placed less than 1m from a microwave, the operation of the wine fridge can be affected.

The fridge is designed for the N-ST climate class. Protect the device from heat (above 38 °C) and cold (below 16 °C), dust, moisture, flooding events and splashes.

- The wine fridge must be positioned so that the power socket remains accessible after installation.
- Unwind the power cord but do not plug it into the electricity supply immediately.
- Install your wine cellar in its final location before loading it. If the fridge is moved while loaded, the fridge walls may be permanently deformed.

**IMPORTANT:** Two people are required to properly and safely install the fridge.

## A. Location

To ensure adequate ventilation of the fridge, allow a minimum of 15 cm between the wine fridge and the nearby walls as shown in the illustration below.

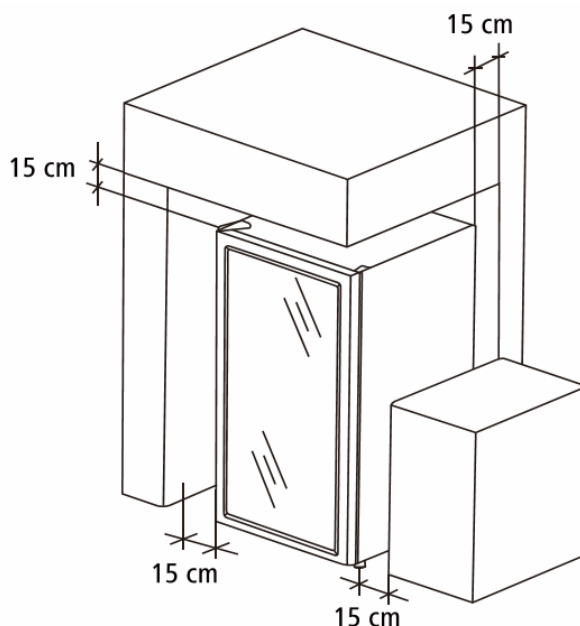

## B Unpacking the age of the device and discarding the packaging elements.

 Remove all packaging, as well as protective elements inside the device's compartments, before turning it on.

 The carton and paper packaging are recyclable. Please dispose of paper packaging in recycling bins.

Materials bearing the symbol  are recyclable. Including: Polyethylene; Polystyrene; and Polypropylene. These materials can be recycled if you dispose of them in collection containers.

Other packaging items (e.g. fasteners) must be disposed of with household waste.

## C. Foot adjustment

Your wine fridge is equipped with an adjustable foot to facilitate levelling.

It is recommended to adjust the front feet to level the wine fridge. Correctly levelled feet will limit noise and vibration of the wine fridge.

Turn the adjustable foot by hand (be careful not to jam your fingers).

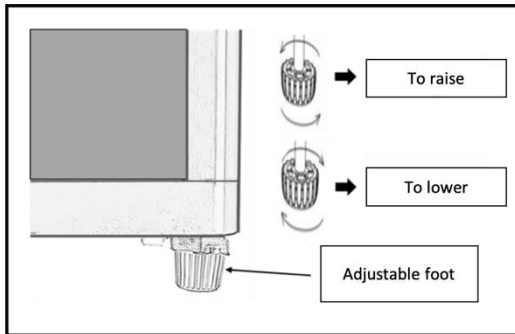

- Turn the foot anti-clockwise to raise the level of the wine cellar

- Turn the foot clockwise to lower the level of the wine cellar

#### D. Before loading the fridge

- Levelling: The wine fridge must be levelled before loading your wine
- Stable floor: Place the fridge on a stable surface where the ground can support the loaded weight (1 full bottle usually weighs 1.3kg).

#### E. Ambient temperature

**i** The wine fridge should be placed in a room with temperatures between 16-38°C. If the ambient temperature is above or below the climatic class, the performance of the wine fridge will be impacted. Cold or warm temperatures can cause fluctuating fridge temperatures, the fridge may not reach the set temperature or may stop working.





## F. Change in the orientation of the door:

The door can be right or left opening. Change the door by following the instructions below.

Making this change requires 2 people.

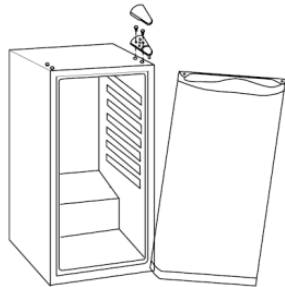
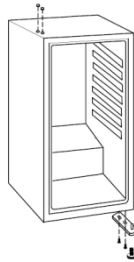
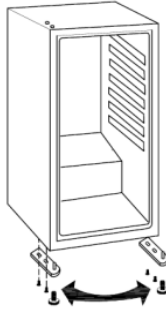
### Instructions for changing the "right-hung" door and reassembling it so it is "left-hung":

<ol style="list-style-type: none"><li>1. Unplug the power cord from the socket.</li><li>2. Remove the top hinge cover.</li><li>3. Unscrew the top hinge and remove it, then remove the door by gently lifting it.</li></ol>	
<ol style="list-style-type: none"><li>4. Unwind the front right foot completely until it comes off. Remove it.</li><li>5. Unscrew the lower hinge and remove it.</li></ol>	
<ol style="list-style-type: none"><li>6. Place the lower hinge on the opposite side after removing the front foot and attach the hinge with the screws you have just removed from the right side.</li><li>7. Replace the foot on the left side of the fridge with the adjustable foot removed from the right side. Screw the smaller foot onto the right side.</li></ol>	
<ol style="list-style-type: none"><li>8. Place the door on the lower hinge. Make sure the glass door is upright and closes easily.</li></ol>	

9. Place the top hinge on the opposite side.
10. Place the door on the fridge, then loosely screw the hinge without tightening completely.

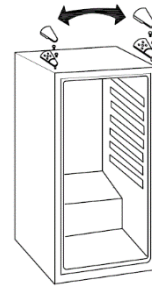

- 11 Once the door is installed, adjust the hinge by tightening the screws until the door is in the correct place.
12. Replace the top hinge cover.

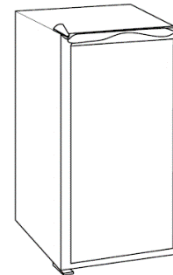

**Note:** The door seal may come out of its place when changing the door. If you notice gaps between the seal and the fridge frame when the door is closed, pull carefully on the seal to close these openings. The correct positioning of the seal is important to ensure the fridge is waterproof.

## IV BEFORE USE



**Wait 24 hours before starting your wine fridge.**

We recommend that you leave your wine fridge upright, clean it with soapy water and leave it open to eliminate residual odours.

### **Recommendations:**

- Place the fridge in a cool place away from sunlight and heat sources.
- Certain parameters such as room temperature, door opening time or the number of bottles stored inside could affect the internal temperature of your wine fridge. We recommend that you check the internal temperature regularly and adjust it if necessary.
- Do not cover the vents.

### **Operating noise:**

To reach the desired temperature, this wine fridge, like all wine fridges with compressor cooling systems, can produce certain noises, which are normal operating noises.

- Gurgling noise: caused by the refrigerant gas circulating in the refrigeration area of the unit.
- Cracking noise: resulting from the contraction and expansion of the gas to produce the cold.

*The perception of noise by the individual is directly related to the environment in which the wine fridge is located. Noise in normal operation is not a cause of the warranty's application.*

## V USING YOUR WINE FRIDGE

### A. Loading your wine fridge

- You can load your wine bottles in single or double rows.
- For loading, take note of the following: if you don't have enough bottles to completely fill your wine fridge, it's best to spread the load over the entire height of the wine cellar to avoid a thermal imbalance at the top or bottom of the fridge.
- The balanced distribution of bottles throughout the height of the wine cellar is the most efficient way to use the energy of the appliance.
- The bottle capacity is expressed in bottles of the "Bordeaux" type. If larger bottles are stored, or if additional shelves are used, the maximum bottle capacity is reduced.
- To accommodate the largest type of bottle or increase the capacity of the cellar by stacking the bottles when necessary, the shelves must be removed or moved (see paragraph adjustable shelves).
- Keep a gap between the bottom of the fridge and the bottles to allow air to flow. As in an underground wine cellar, air circulation is important for a homogeneous temperature inside your wine fridge.

This will also reduce energy consumption.

### IMPORTANT INFORMATION ABOUT THE SERVING TEMPERATURE OF WINE

Your wine fridge has been designed to allow you to set desired serving temperature of your wine. Each wine varietal is served at a different ideal temperature.

The temperature of the cellar is adjustable from 5-20 °C. Unless the wine producer says recommends a different temperature for your particular wine, champagne should be served at 7°C, white wine should be served at 12°C and red wine should be served at 18°C (see "Wine Service Temperature" recommendation table).

Some wines can be served young (2 to 3 years), while others are much better aged (10 years and older). Each wine peaks at a different age. Check the ideal drinking age for your wine with your wine merchant.

**SETTING TYPES:** Please note that depending on where your wine fridge is kept, how often the door is open, the ambient temperature and the loading, the time taken to reach the set temperature varies. Usually, it takes about 24 hours for the wine fridge to reach the desired temperature and indicate a stable temperature on the digital display. The temperature displayed will change when the desired temperature is adjusted or whenever a large number of bottles are added to the fridge.

## B. Loading plan

Your wine cellar can accommodate up to 105 bottles, of light Bordeaux type, with a stack based on three shelves.

 While loading several levels of bottles on the same shelf, please gently store your bottles in the 1st row to prevent them from colliding with the 2nd row. Store the bottles in a "head to tail" - crossing the neck and bottom of each bottle, so you can get close to the stated maximum capacity.

If you store larger bottles or add a shelf to more easily access your bottles, storage capacity will be reduced.

The way you load your fridge and the number of shelves, determines capacity. Below you will find an explanatory diagram for loading (capacity with load "head to tail"):

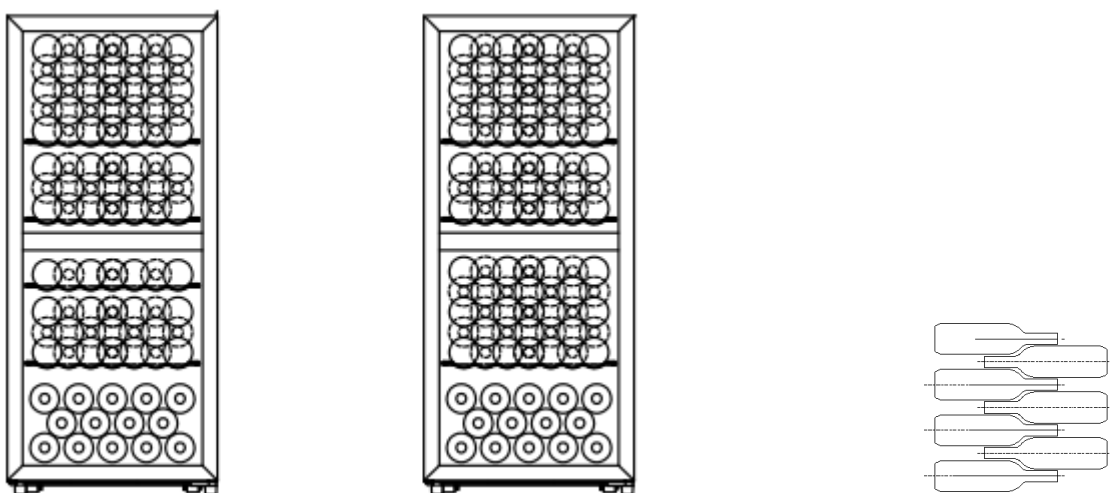

The indoor fan helps keep the temperature consistent throughout the fridge. The fridge door should not be kept open for long periods of time as it will impact the fridge's ability to remain cool.

This fridge is a multi-zone fridge which allows you to set the temperature of each compartment independently. As wine is best served at different temperatures depending on the type of wine, you can store multiple types of wine in your fridge at their ideal temperatures following the temperature settings below:

- Top compartment of the unit (5-12°C): rosé wines, champagne and white wines
- Bottom compartment of the unit (from 12-18°C): red wines



### C. Adjustable shelves

Your wine fridge has 4 adjustable metal shelves, which gives the strength to stack several rows of bottles (the moulding at the bottom of the fridge allows bottles to be stacked underneath the bottom shelf).

The shelves can be adjusted to different spacings depending on your needs (be careful not to place bottles on the temperature zone separator).

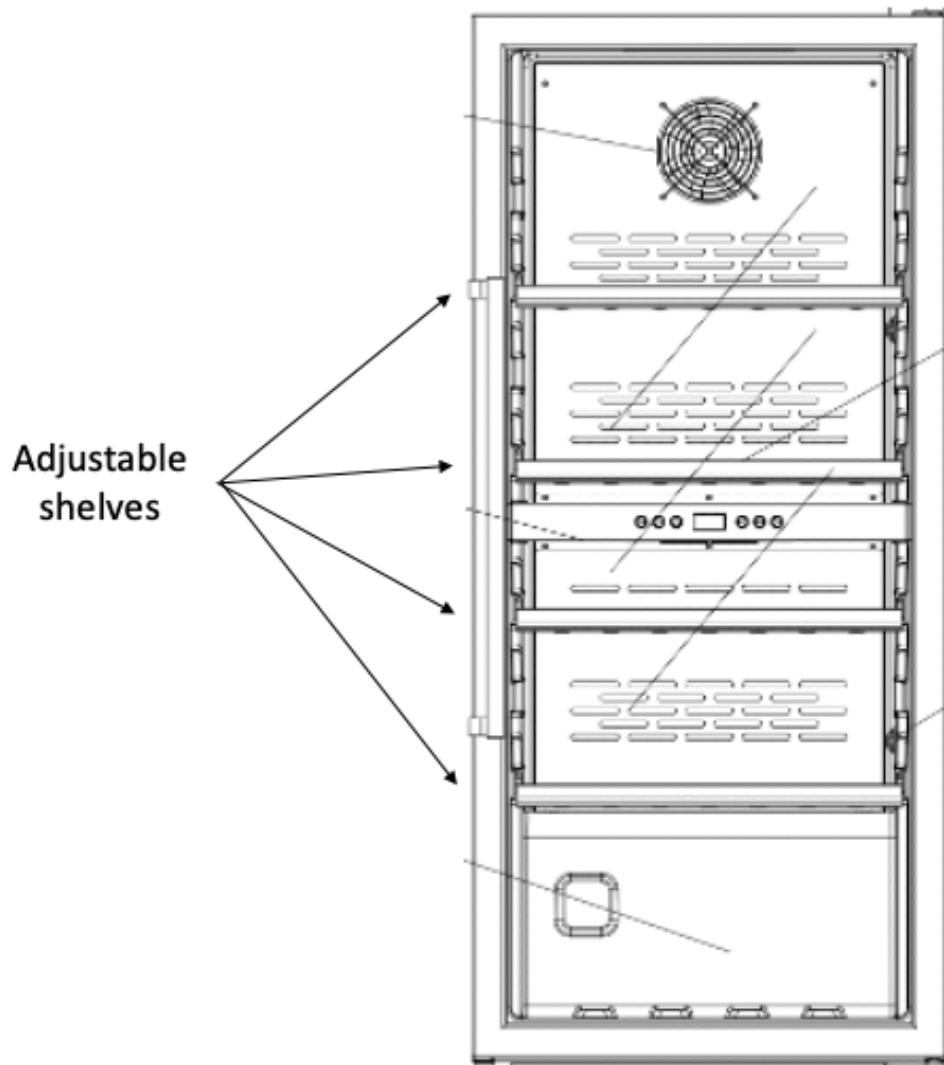

- Door seal protection: Ensure you open the door completely before removing shelves from their rails.
- Do not slide multiple loaded shelves outwards as it may cause bottles to fall or may cause the wine fridge to tip forward.
- Do not cover shelves with material like aluminum foil or metal plate as this will impact internal airflow.
- Do not move your wine fridge while it is loaded with bottles. This could distort the walls of the wine fridge and cause back injuries.

#### **D. Functions and temperature setting**

Please note that depending on the selected settings and the loading, it can take 24 hours for the wine fridge to reach the desired temperature.

- Plug the power cord into a suitable power supply
- Set the thermostat to adjust the temperature using the K4 and K5 keys

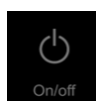
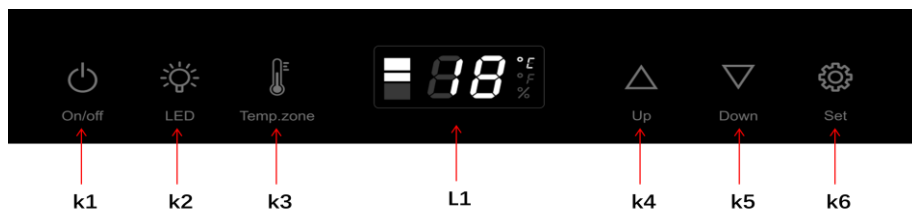

### On/Off

K1: Start or turn off the wine fridge



### Light

K2: This button allows you to turn on / off the inside light

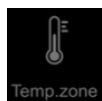

### Select the storage area

K3: Top, central or bottom zone (refer to page 24 for recommended temperature settings)



### View temperature by selected area

L1: Temperature display

Top zone: 5- 12 °C

Bottom zone: 12-18 °C





### **Increase temperature**

K4: Press the button once, the LED display will flash indicating the current temperature. Press again to set the temperature. 1 touch will increase the temperature by 1 degree. The blink stops after 5 seconds without action on your part, and the new temperature requested is recorded. The LED display then shows the actual temperature inside.

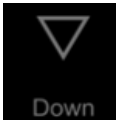

### **Decrease temperature**

K5: Press the button once, the LED display will flash indicating the current temperature. Press again to set the temperature. 1 touch will reduce the temperature by 1 degree. The blink stops after 5 seconds without action on your part, and the newly set temperature is recorded. The LED display then shows the actual inside temperature



### **Settings**

#### **Fahrenheit/Celsius**

K6: Switch the temperature display between Fahrenheit/Celsius by pressing the button

There are two internal fans for airflow however fluctuations of up to 3 degrees is expected. The average temperature throughout the fridge will be a maximum of 1.5°C of the requested temperature (once sufficient time for cooling has passed). Once a temperature difference of 3°C above the set temperature is detected, the cooling cycle will start to bring the temperature down to below the set temperature. Once the cooler temperature is reached, the cooling stops and the temperature inside the fridge is allowed to slowly increase. This cycle is continuous and results in a very small range of constant fluctuation.

The temperature sensor is placed halfway down the compartment and reads the temperature instantaneously. Small amounts of deviation in temperature is expected (less than 6°C).

Please do not open the door too often as this will disrupt the operation of the temperature sensors. The fridge automatically adjusts moisture and condensation levels within the fridge as required.

 **Attention**

When the temperature sensor is failing due to power outage or bug, an error code appears.

E1 internal temperature problem

E2 ambient temperature problem

CE communication problem

**E. Wine service temperatures:**

The table below shows the recommended serving temperatures for different wine.

<b>Wine</b>	<b>Recommended temperature</b>
Champagne, sparkling	6 °C
White: Sémillon, Sauvignon Blanc	8 °C
Vintage Champagne	10 °C
Dry white: Chardonnay	10 °C
Dry white: Gewürztraminer, Riesling, Pinot gris	10 °C
Sweet late harvested white: Sauternes, Barsac, Monbazillac	10°C
Beaujolais	13°C
Sweet white wine: Sauternes...	14 °C
White Chardonnay vintage	14 °C

Pinot Noir Red,	16 °C
Red Grenache, Syrah	16 °C
Red vintage Pinot Noir	18°C
Other red wines	Temperature not exceeding 20°C

To bring the wine to the serving temperature, it is recommended to place it in your wine cellar at least 48 hours before serving, and uncork or aerate a few minutes before tasting.

## F. Power outage

 In the event of a power outage, all temperature settings will be automatically preserved, unless you change the thermostat setting.

A power outage of an hour or two will not affect the temperature of your wine cellar. To avoid a sudden change in temperature when the power supply is turned off, you should avoid opening the door. In the event of a prolonged cut, storage alternatives must be found to preserve your wine.

 If you plan to temporarily shut off the electrical power or if there is a power outage scheduled by your power provider, it is imperative to disconnect the power socket rather than have your power meter shut down. A sudden shutdown of the current could damage the mother board in your wine fridge

### A. Defrosting

Your wine cellar is designed with a "natural" defrosting system. When the engine is shut down, the refrigerated surfaces of the wine cellar automatically defrost. The de-icing water descends into a drainage container near the compressor at the back of the wine fridge. This water is evaporated by the heat produced by the compressor.

 **Important:** Keep the drain and gutter clean to prevent it to clog and water to flow inside the wine fridge.

### B. Cleaning



Before cleaning or restarting, unplug at the socket.

Never use abrasive products or sponges with scrapers for cleaning inside or outside your device.

- Remove all accessories (e.g. shelves, water tank). Wash them with lukewarm water with a mild, odorless detergent (an unscented dish liquid, for example), rinse with water containing bleach and dry thoroughly.
- Wash the interior walls in the same way; take special care of the shelves.
- Wash the door seal without omitting to clean also under the door seal
- Reconnect the device and get it back into operation.

Occasionally, dust the condenser at the back of the unit; a build-up of dust could reduce the performance of the unit.

At certain times of the year, condensation on the door may occur. If this happens, wipe the water from the door and avoid opening the door of the fridge often as this amplifies the difference between the inside of the fridge and the ambient temperature.

In case of prolonged absence, empty and clean the appliance; keep the door ajar for the duration of non-use.



**Important!**

When the wine fridge is not used:

- Unplug the appliance
- Remove all objects inside.
- Clean and dry the interior space of the wine fridge per the above instructions.
- Leave the door slightly ajar to avoid mold.

## VII TROUBLESHOOTING

Some issues can be easily resolved. Before using after-sales service or a repairman, please see the following table:

<b>Problem</b>	<b>POSSIBLE CAUSES</b>
The wine cellar doesn't work.	The fridge is not plugged in or it is switched off The circuit breaker is triggered, or the fuse is damaged. Check to see if the power outlet is powered by connecting another electrical appliance.
The wine cellar is not cold enough.	Check the temperature setting. A high ambient temperature may require a lower setting. The door is opened too often. The door is not completely closed. The door seal is not properly positioned.
The compressor works and goes out often.	The room temperature is warmer than normal. A large quantity of bottles has been added to the wine cellar. The door is opened too often. The door is not completely closed. Temperature control is not properly defined. The door seal is not properly positioned.

The light doesn't work.	<p>The socket is not plugged in.</p> <p>The circuit breaker has gone off or a fuse is damaged.</p> <p>The lighting button is stuck on "OFF."</p>
Vibration.	The wine fridge may not be level.
The wine cellar seems to be making too much noise.	<p>Squeaking or slamming may come from the circulation of the refrigerant gas, which is normal.</p> <p>At the end of the cycle, the compressor emits a noise caused by the passage of the refrigerant into your wine cellar.</p> <p>The contraction and expansion of the gas inside the walls can emit hissing and crackling.</p> <p>The wine cellar is not level, check the setting of the feet.</p>
The door doesn't close properly.	<p>The door was reversed and not properly reinstalled.</p> <p>The seal is defective (the magnet or rubber is altered).</p> <p>The shelves block the door closure.</p>

If your wine fridge doesn't seem to be working normally, unplug the device for a few minutes, then plug it again to reset the fridge

If the problem persists or for any other problems occurring at your device: **contact the After-Sale Service by email: [hello@tromph-australia.com](mailto:hello@tromph-australia.com)**

Any service or repair on the cooling process must be carried out by a licensed professional who will have to carry out an inspection of the refrigeration circuit.

Similarly, any service or repairs on the electrical circuit must be carried out by a qualified electrician.

**Note:** Any repair by an unlicensed technician will result in cancellation of the warranty.

## VIII WARRANTY

### WARRANTY EXCLUSIONS

The warranty does not cover the wear parts of the product, or the problems or damage resulting from:

- (1) superficial deterioration due to normal wear and tear of the product.
- (2) defects or deteriorations due to the product's contact with food or liquids, and due to corrosion caused by rust.
- (3) any unauthorised incident, abuse, improper use, modification, dismantling or repair.
- (4) any improper maintenance operation, non-compliant use of the product or connection to an incorrect voltage.
- (5) any use of accessories not supplied or approved by the manufacturer.



**The warranty will be waived if the rating plate and/or serial number of the product is removed.**



## **IX CAUTION**

For more information about disposing of your fridge, you can contact your local or regional government. Electronic products that have not been selectively sorted are potentially hazardous to the environment and human health due to the presence of hazardous substances

This wine cellar contains flammable foaming agents.

At the end of your product life, it must be disposed of in an appropriate location, capable of recycling refrigerators, freezers, and wine cellars. To do this contact your local council.

Under no circumstances should you dispose of this wine fridge during curbside collections.