

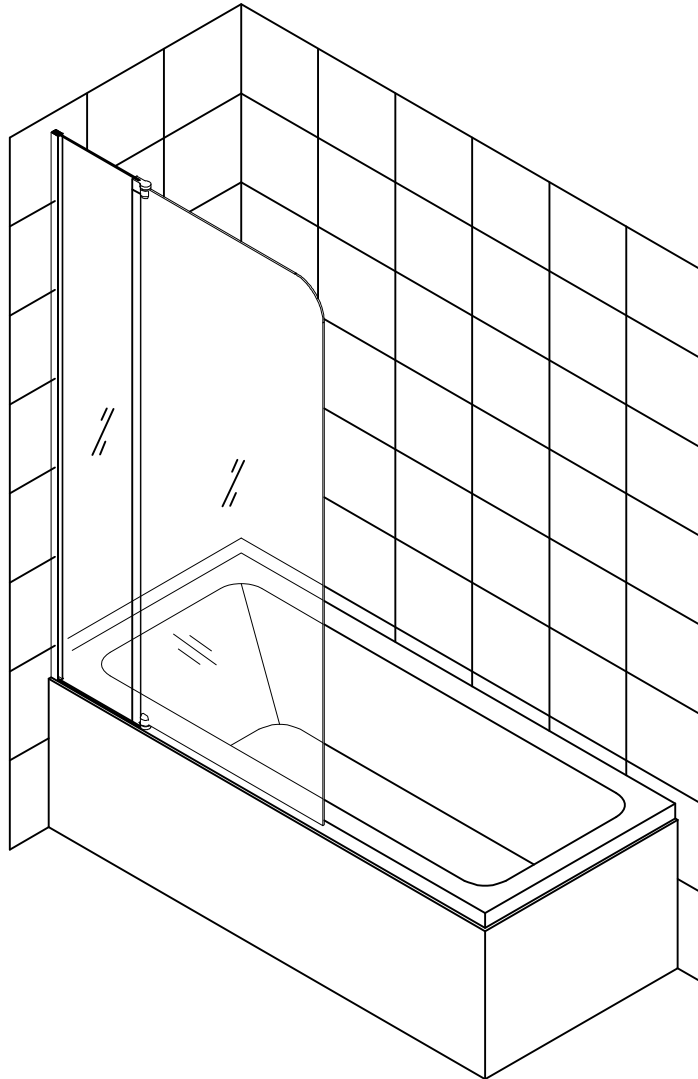

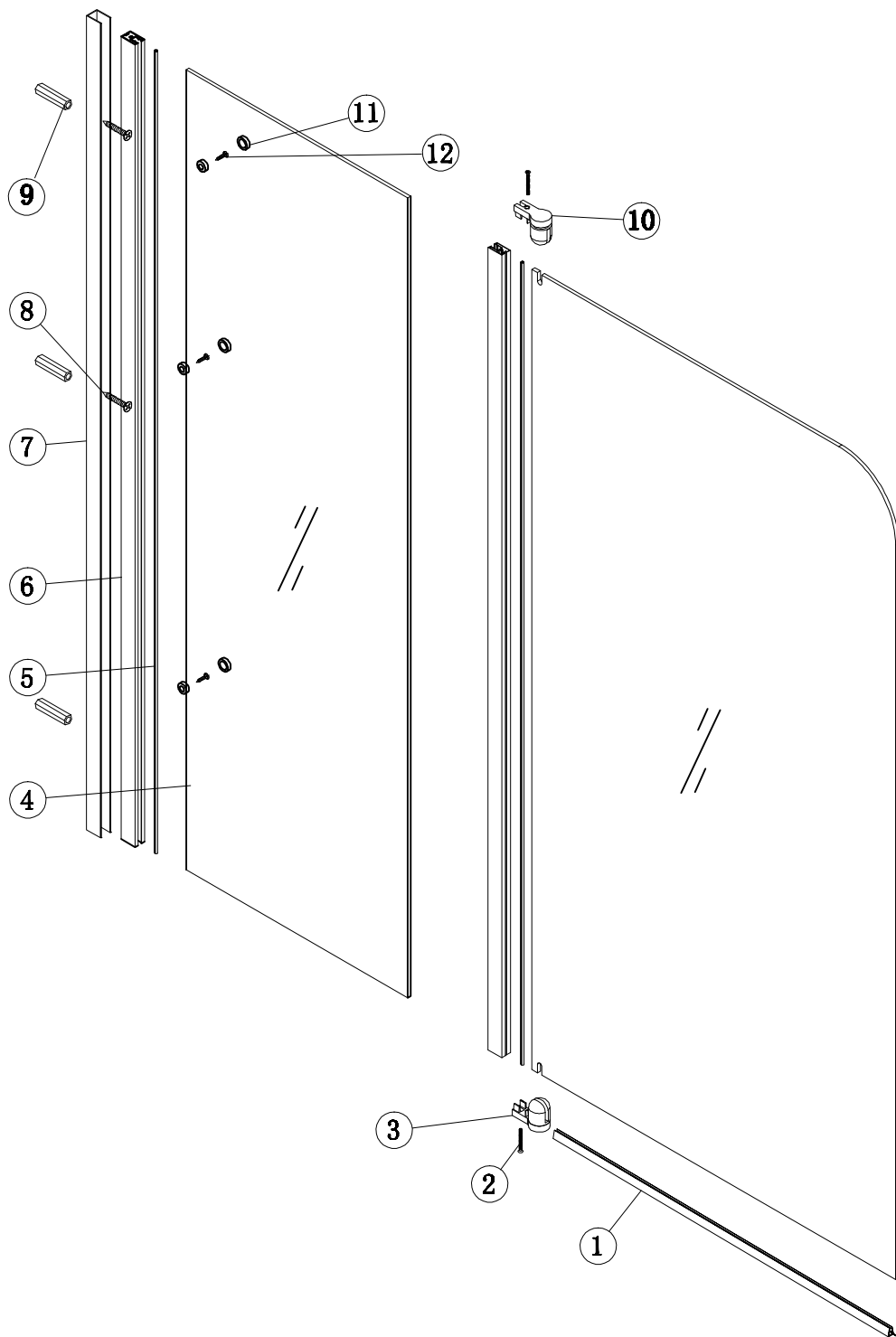









# INSTALLATION MANUAL



## INSTRUCTIONS FOR ASSEMBLY, INSTALLATION AND USE

Model Code: CVP010



| NO. | NAME          | PICTURE   | Qty | NO. | NAME                        | PICTURE   | Qty |
|-----|---------------|---|-----|-----|-----------------------------|---|-----|
| 1   | The strip     |  | 1   | 7   | Upright Profile             |  | 1   |
| 2   | Flat ST4*40   |  | 2   | 8   | Round ST4*40                |  | 3   |
| 3   | The shaft     |  | 1   | 9   | Ø8Screw colloidal particles |  | 3   |
| 4   | Moved glass   |  | 2   | 10  | Up shaft                    |  | 1   |
| 5   | Sealing strip |  | 1   | 11  | Decorative covers           |  | 3   |
| 6   | Wall Profile  |  | 2   | 12  | ST4*16                      |  | 3   |

1

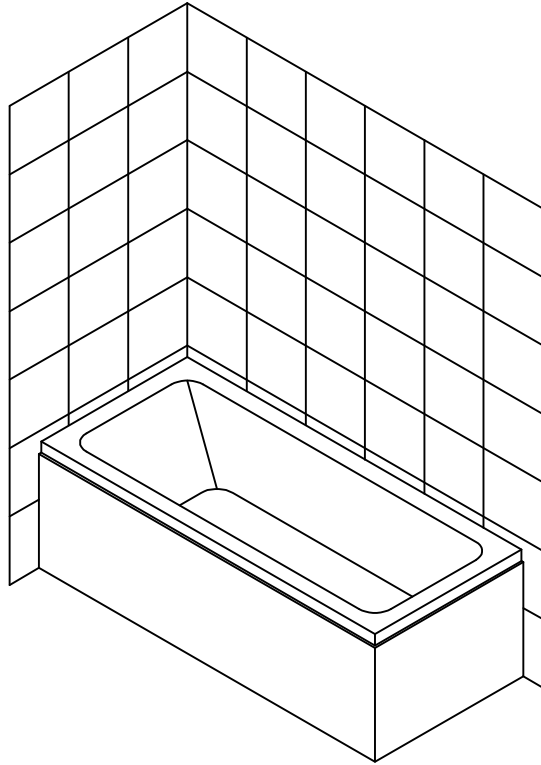

2

