

Wardrobe

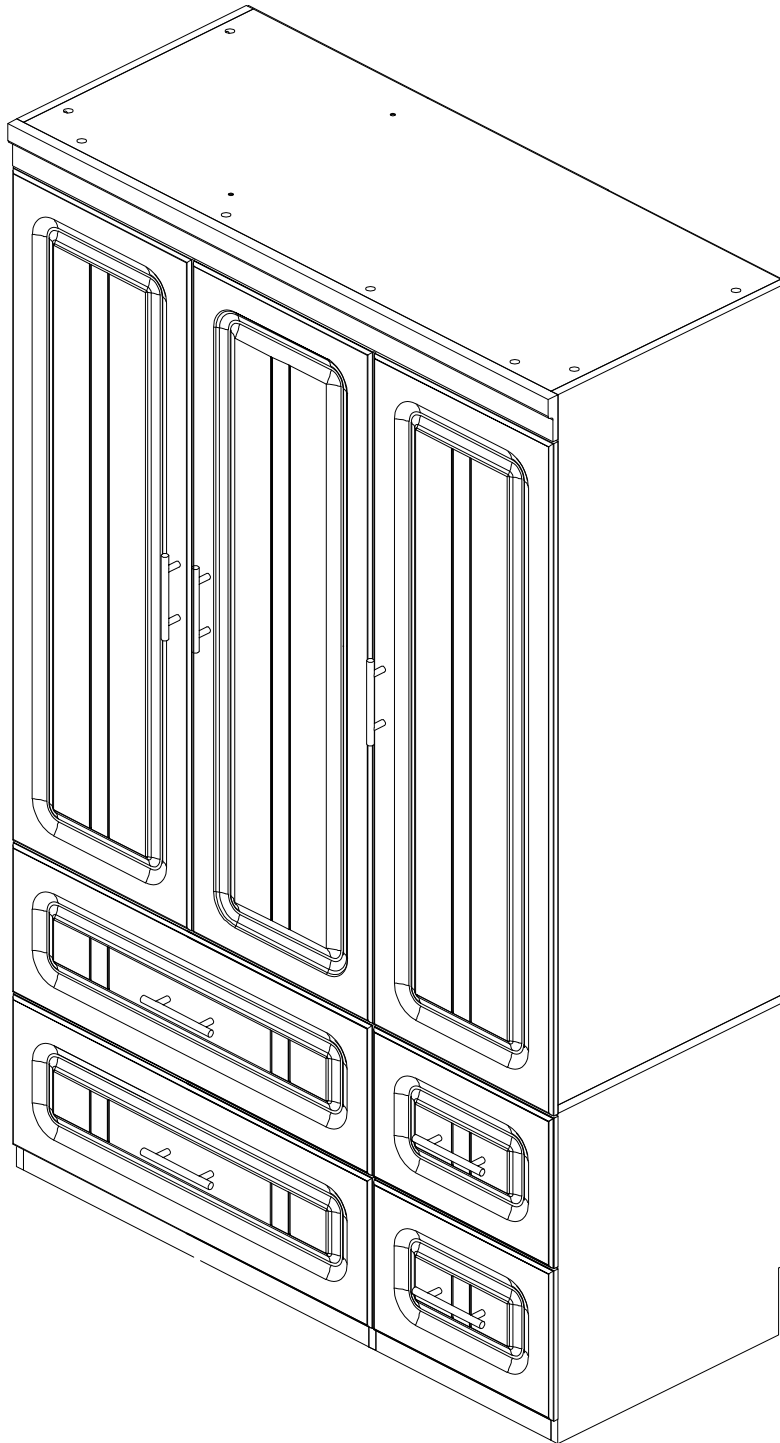

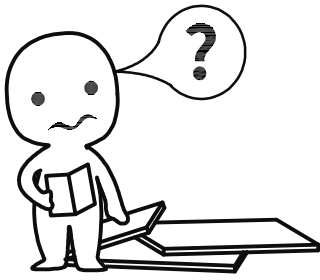

IMPORTANT INFORMATION!

please read the entire manual before starting to assemble and/or using this product. follow the manual thoroughly and keep it for further reference.

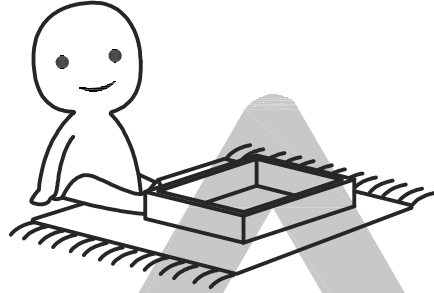
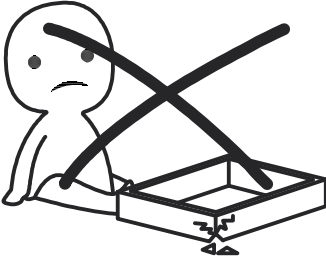

AVOID SCRATCHES!

In order to avoid scratching this furniture should be assembled on a soft layer- could be a rug.

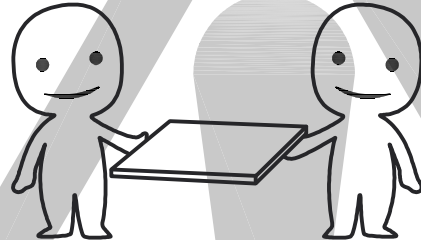

IMPROVE EFFICIENCY !

Try to find a partner to install with you, which can speed up the installation efficiency and shorten the time.

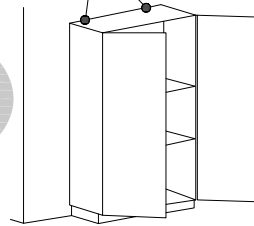
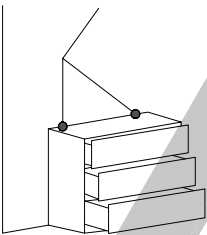

ANTI-TOPPLE WARNING !

Overtipped furniture can cause serious or fatal crush injuries. To prevent tipping over, be sure to use the wall attachment, if not included with this product. Please purchase the wall attachment that fit your wall. If unsure, seek professional advice. Please read and follow each step of the instructions carefully.

IMPORTANT !

It is important that any product which is assembled using any kind of screw is re-tightened 2 weeks after assembly, and once every 3 months - in order to assure stability through-out the lifespan of the product.

For regular maintenance and cleaning of the product, for the frame, please use a rag dipped in neutral detergent to fully wipe it, and then dry it with a clean rag. For glass materials, wipe with a rag dampened with water glass cleaner, and then dry with a dry rag.

Do not use an electric screwdriver, and do not use too much force when installing, because the board is easy to break.

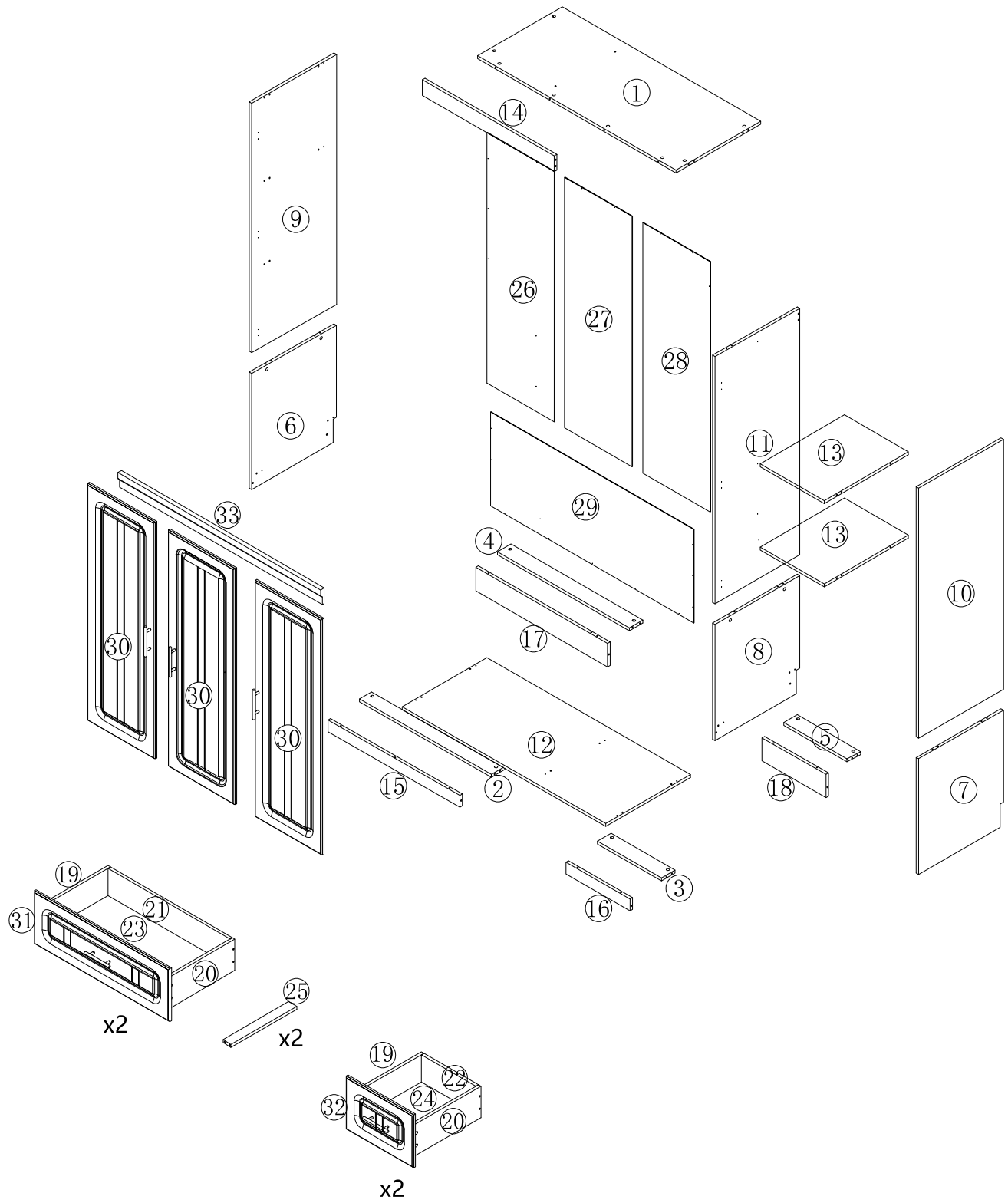

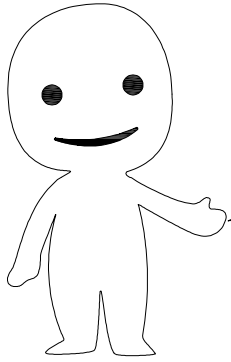



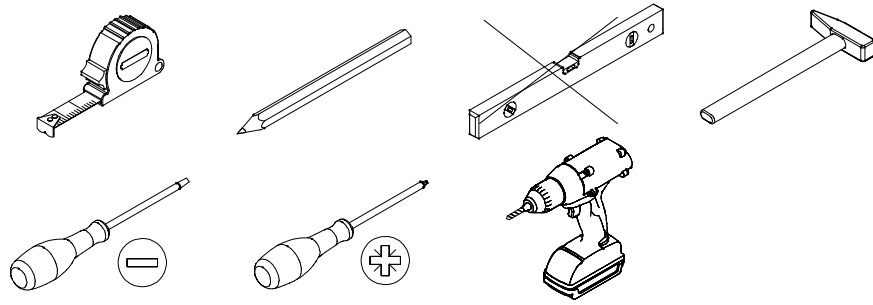





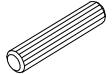
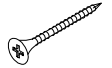







Please prepare the following tools

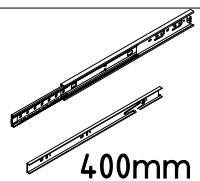

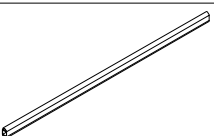
When installing, please carefully confirm whether each screw corresponds to the manual, accessories with similar shapes can be distinguished by size

<p>A x 62</p>  <p>φ6 x 34mm</p>	<p>B x 62</p>  <p>φ15 x 12mm</p>	<p>C x 52</p>  <p>φ8 x 30mm</p>	<p>D x 8</p>  <p>φ4x 40mm</p>
<p>E x 16</p>  <p>φ4x 30mm</p>	<p>F x 34</p>  <p>φ3x 12mm</p>	<p>G x 11</p>  <p>15.5x10x 1.2mm</p>	<p>H x 11</p>  <p>φ3x 16mm</p>
<p>J x 4</p>  <p>φ35mm</p>	<p>K x 2</p>  <p>φ35mm</p>	<p>L x 36</p>  <p>φ4*16mm</p>	<p>M x 7</p>  <p>150mm</p>
<p>N x 14</p>  <p>M4 x 18mm</p>	<p>P x 4</p>  <p>400mm</p>	<p>Q x 32</p>  <p>φ3.5*14mm</p>	<p>R x 2</p> 
<p>S x 1</p>  <p>770mm</p>	<p>T x 4</p>  <p>φ4*14mm</p>	<p>U x 1</p>  <p>1 PCS</p>	

**Slides Must Be Separated Before Assembly.
After Separated, Set Aside Until Needed for Assembly.**

Las diapositivas deben separarse antes del montaje.
Después de la separación, déjelo a un lado hasta que sea necesario.

Les glissières doivent être séparées avant l'assemblage.
Après la séparation, mettez de côté jusqu'au moment de l'assemblage.

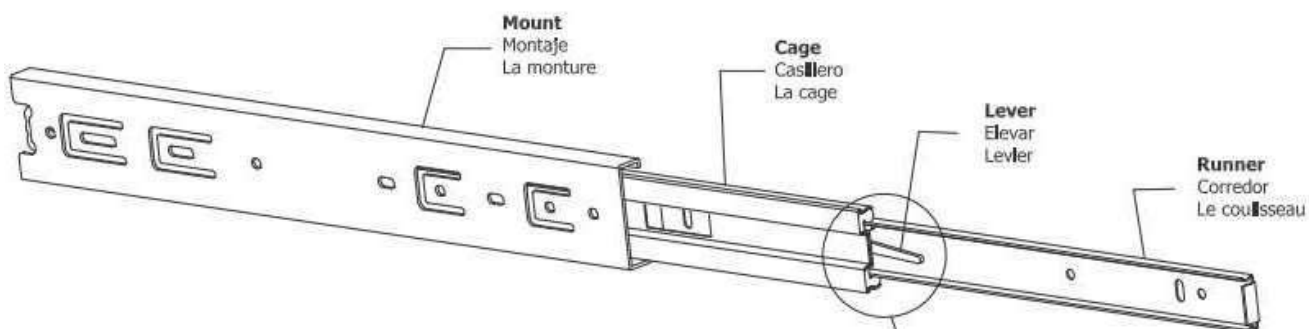

STEP 1: Extend Slide
Extender la diapositiva
Extendre la diapositive

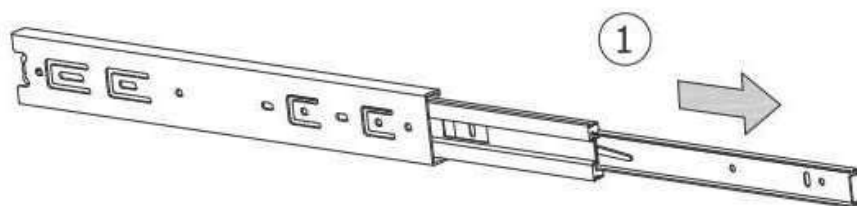

STEP 2: Push Lever UP
Empujar hacia arriba
Lever le levier

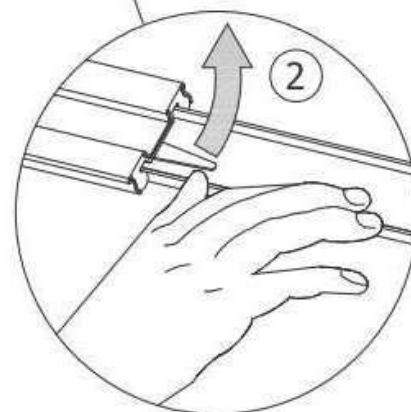

STEP 3: Remove Runner
Quitar el corredor
Enlever le coureur

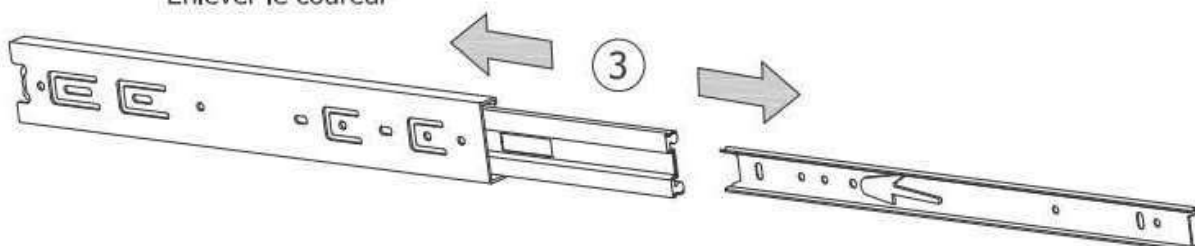

1

A x 4



φ6 x 34mm

B x 4



φ15 x 12mm

C x 2



φ8 x 30mm

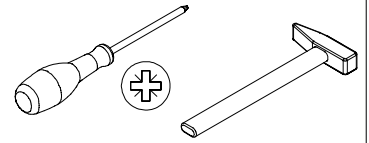

Do not use an electric screwdriver, do not use force during the rotation of the accessories, otherwise it may cause the board to crack

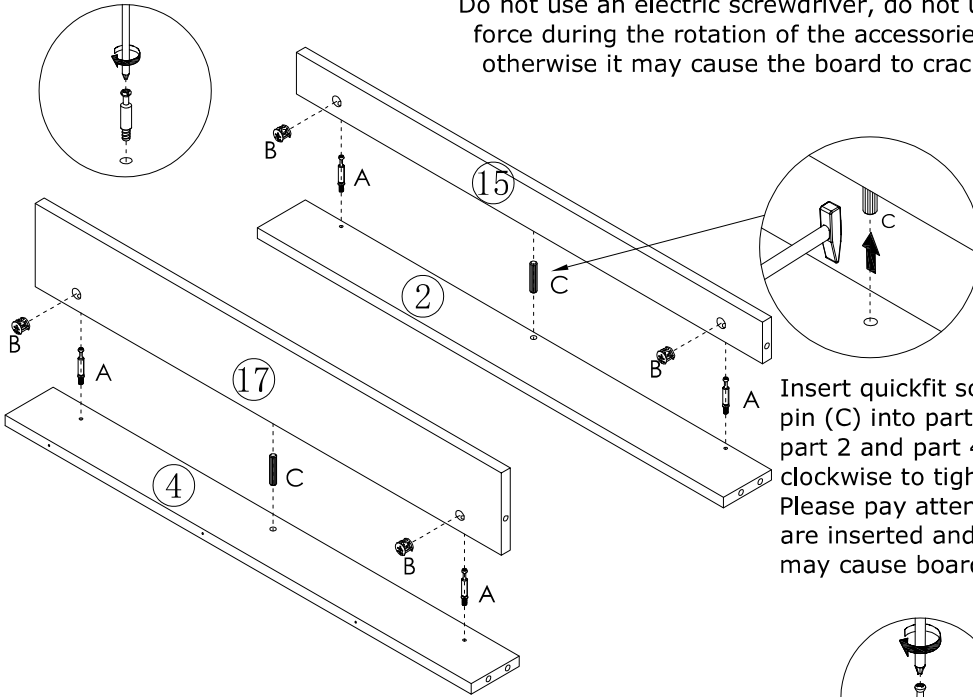
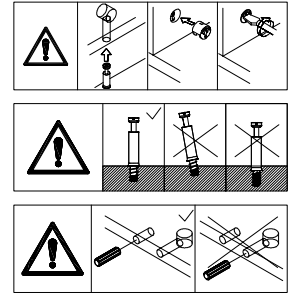

Insert quickfit screw (A) into part 2&4. Hammer wooden pin (C) into part 15&17. Attach part 15 and part 17 to part 2 and part 4 respectively, turn cam locks (B) clockwise to tighten as shown. Please pay attention to the holes where the accessories are inserted and don't use an electric screwdriver which may cause board crack.

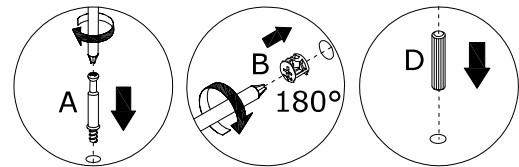

2

A x 4



φ6 x 34mm

B x 4



φ15 x 12mm

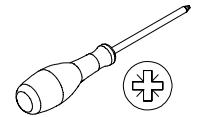

Insert quickfit screw (A) into part 3&5. Attach part 16 and part 18 to part 3 and part 5 respectively, turn cam locks (B) clockwise to tighten as shown. Please note don't use an electric screwdriver or use force to rotate, may cause board crack.

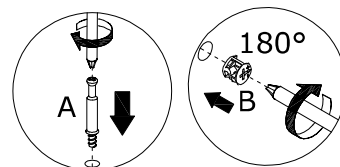
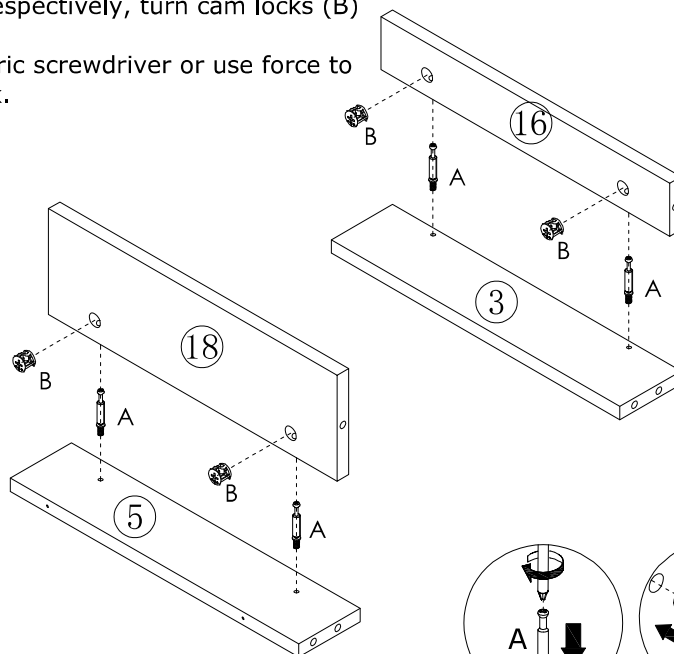
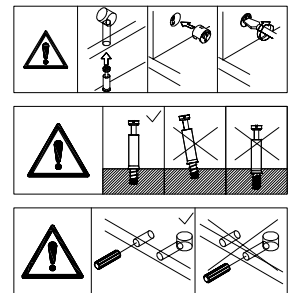

3



Fix runner (P) to part 6, 7 and 8 with screw Q as shown. Please note the front and back of part 8 both require to assemble runners.

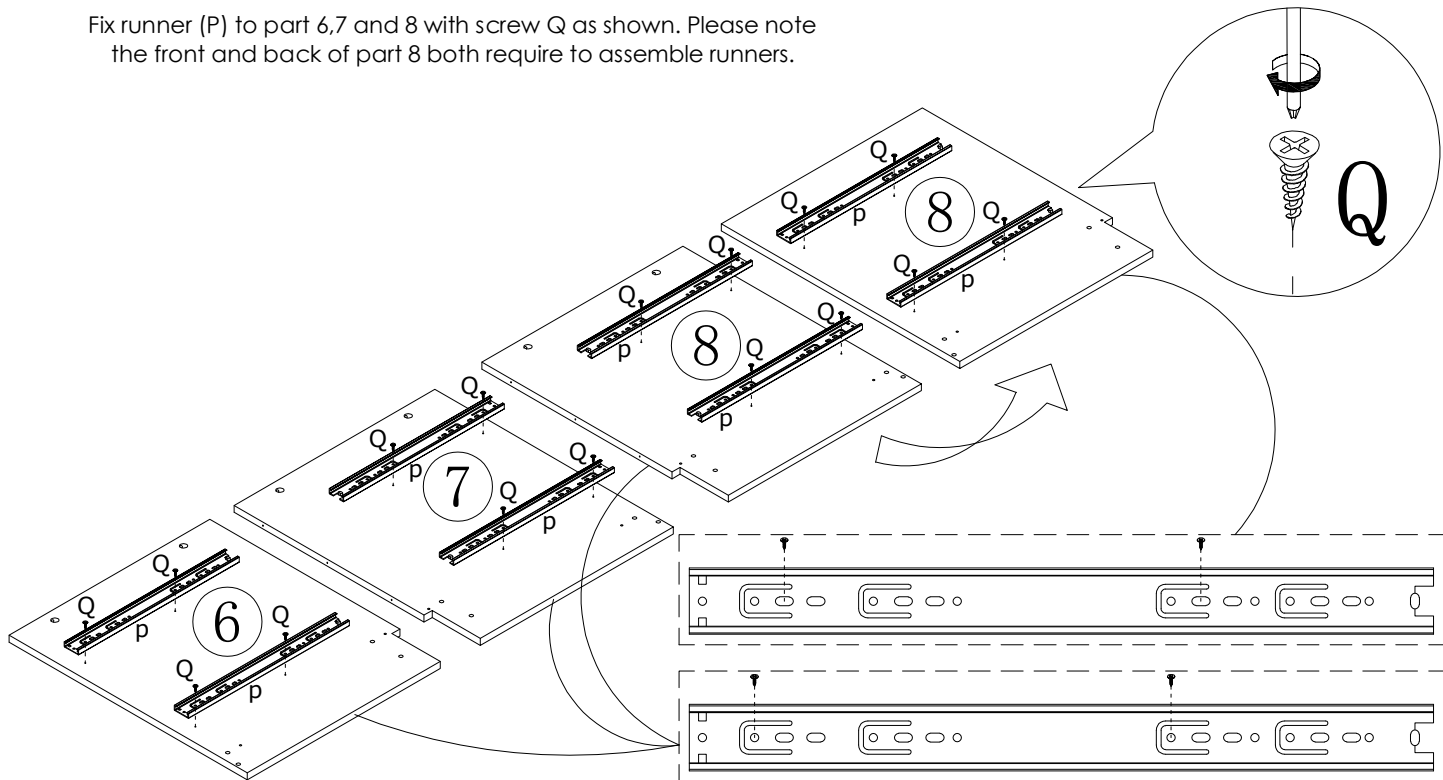

4

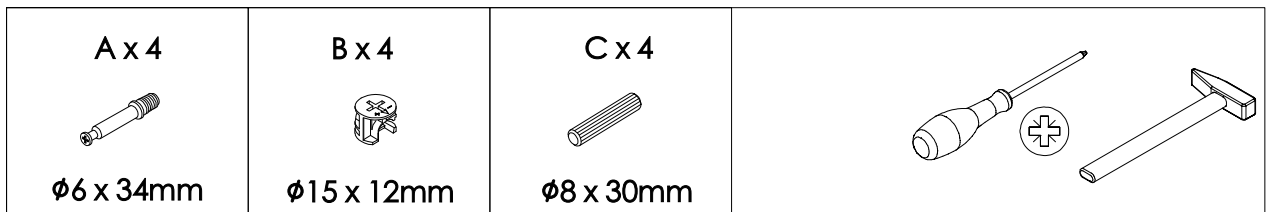

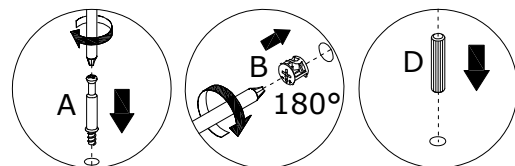
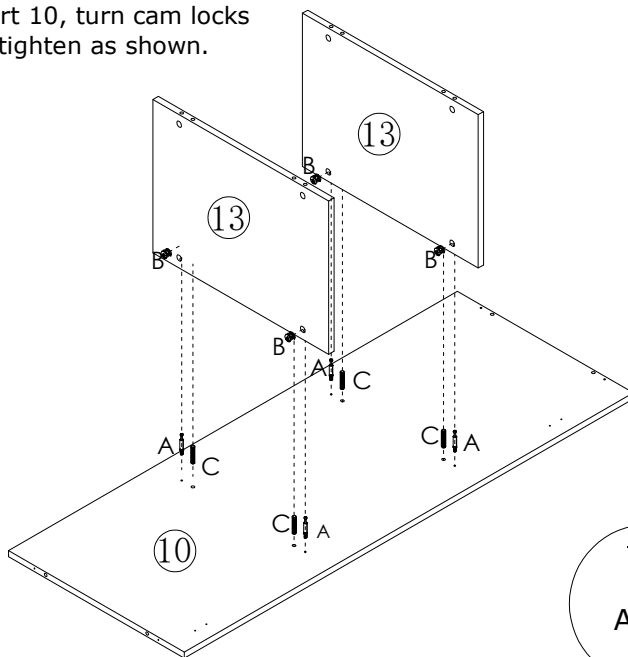
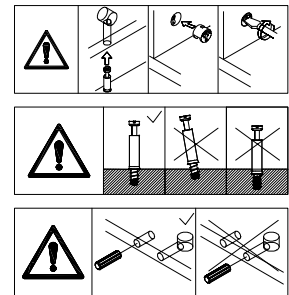

Insert quickfit screw (A) into part 10.
Hammer wooden pin (C) into two part 13.
Attach part 13 to part 10, turn cam locks (B) clockwise to tighten as shown.

Please pay attention to the holes where the accessories are inserted



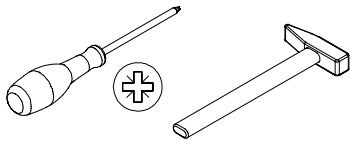

5

<p>A x 4</p>  <p>∅6 x 34mm</p>	<p>B x 4</p>  <p>∅15 x 12mm</p>	<p>C x 4</p>  <p>∅8 x 30mm</p>	
---	--	---	---

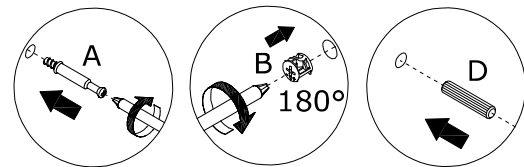
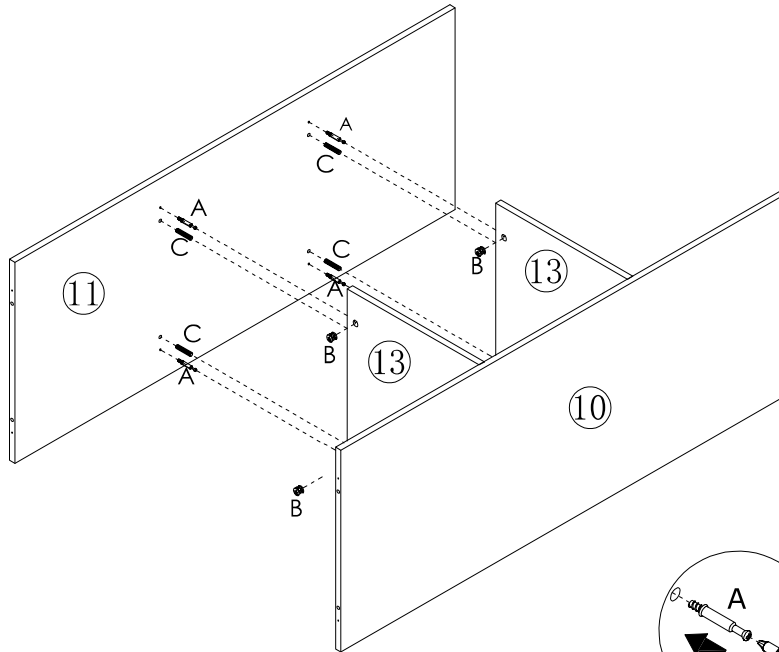
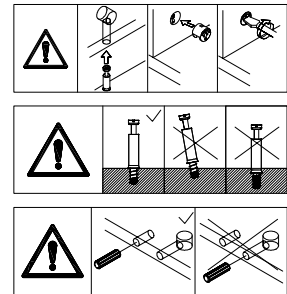
Insert quickfit screw (A) into part 11. Hammer wooden pin (C) into two part 13. Attach part 11 to part 13, turn four cam locks (B) clockwise to tighten as shown.





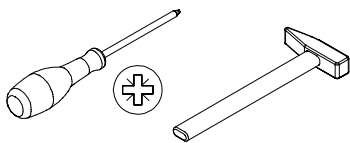

6

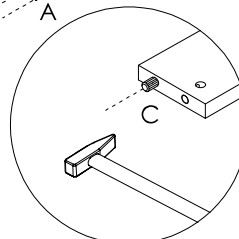
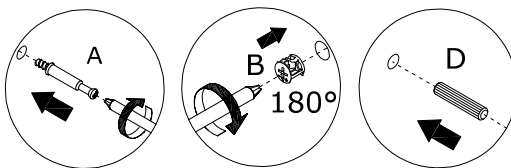
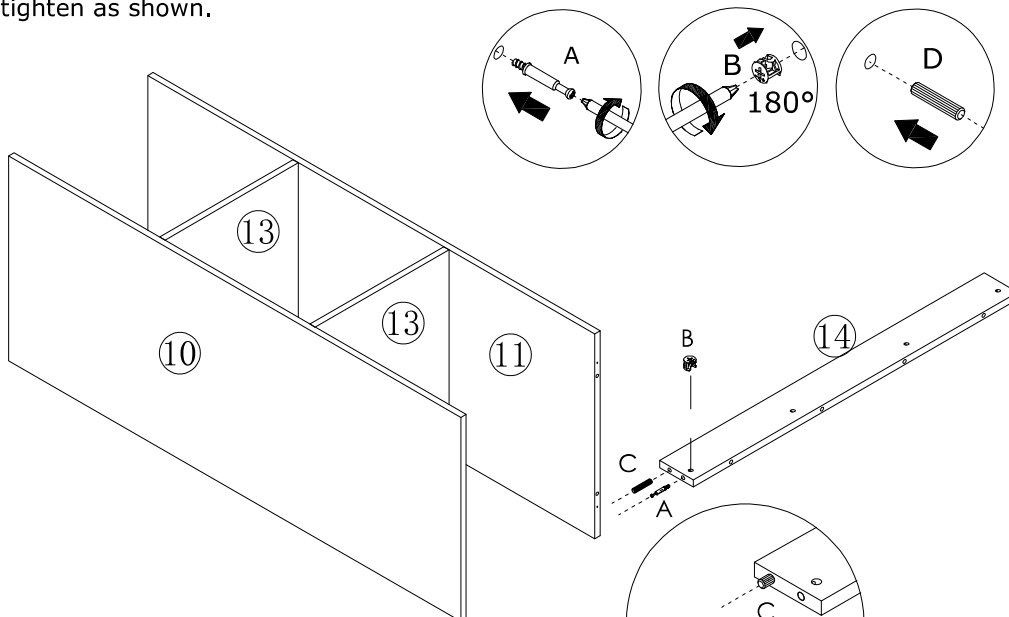
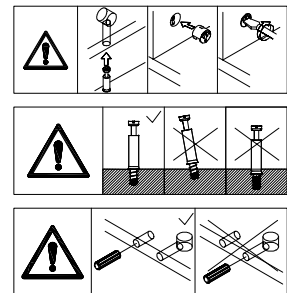
<p>A x 1</p>  <p>∅6 x 34mm</p>	<p>B x 1</p>  <p>∅15 x 12mm</p>	<p>C x 1</p>  <p>∅8 x 30mm</p>	
---	--	---	---

Insert quickfit screw (A) into part 11. Hammer wooden pin (C) into part 14. Attach part 14 to part 11, turn cam locks (B) clockwise to tighten as shown.



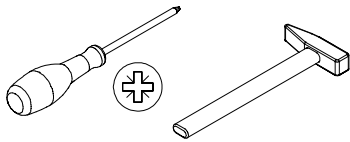

7

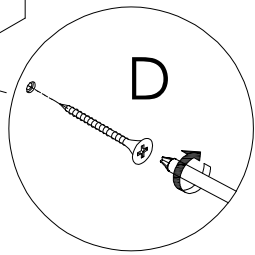
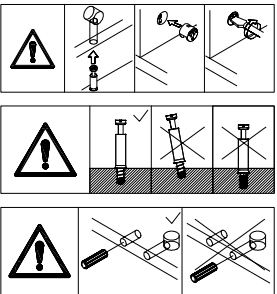
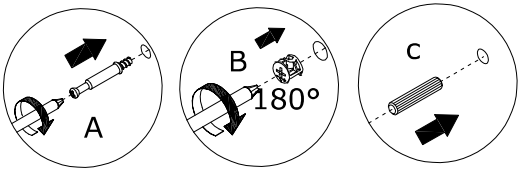
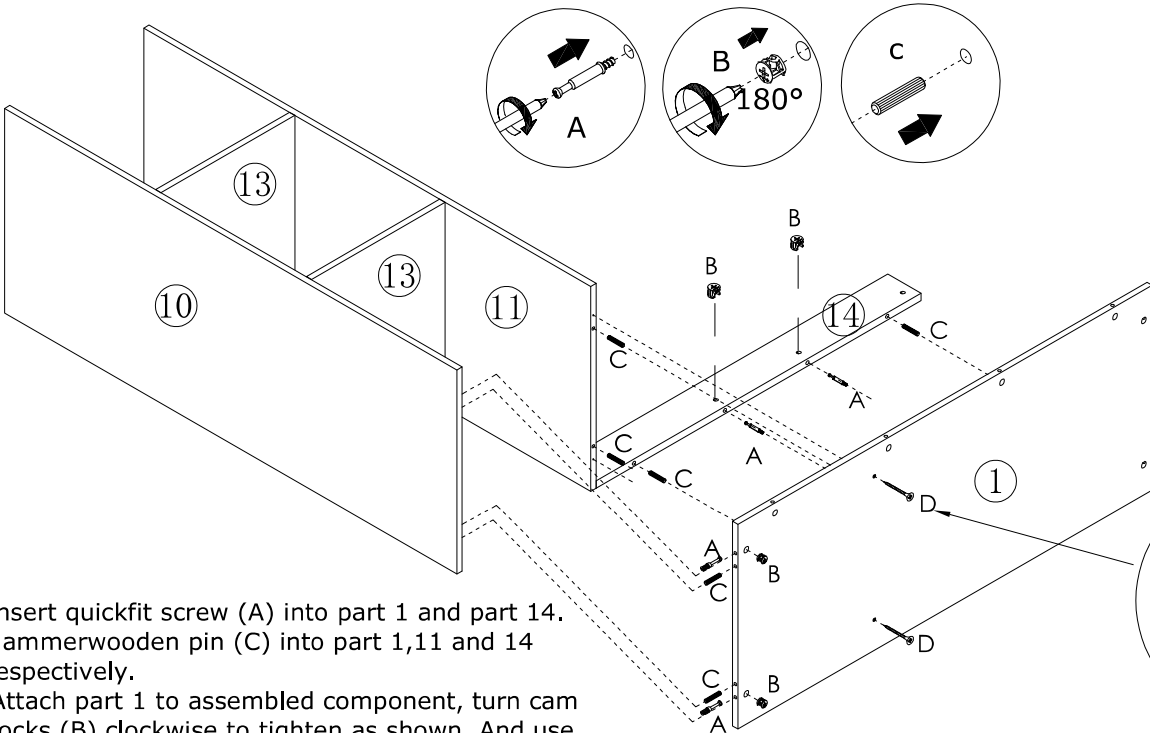
A x 4  $\phi 6 \times 34\text{mm}$	B x 4  $\phi 15 \times 12\text{mm}$	C x 6  $\phi 8 \times 30\text{mm}$	D x 2  $\phi 4 \times 40\text{mm}$	
--	---	--	--	---



Insert quickfit screw (A) into part 1 and part 14.
 Hammer wooden pin (C) into part 1, 11 and 14 respectively.
 Attach part 1 to assembled component, turn cam locks (B) clockwise to tighten as shown. And use screw (D) to fix part 1 and part 11 as shown.

8

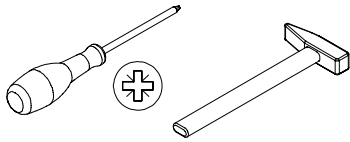
A x 3  $\phi 6 \times 34\text{mm}$	B x 3  $\phi 15 \times 12\text{mm}$	C x 3  $\phi 8 \times 30\text{mm}$	
--	---	--	---

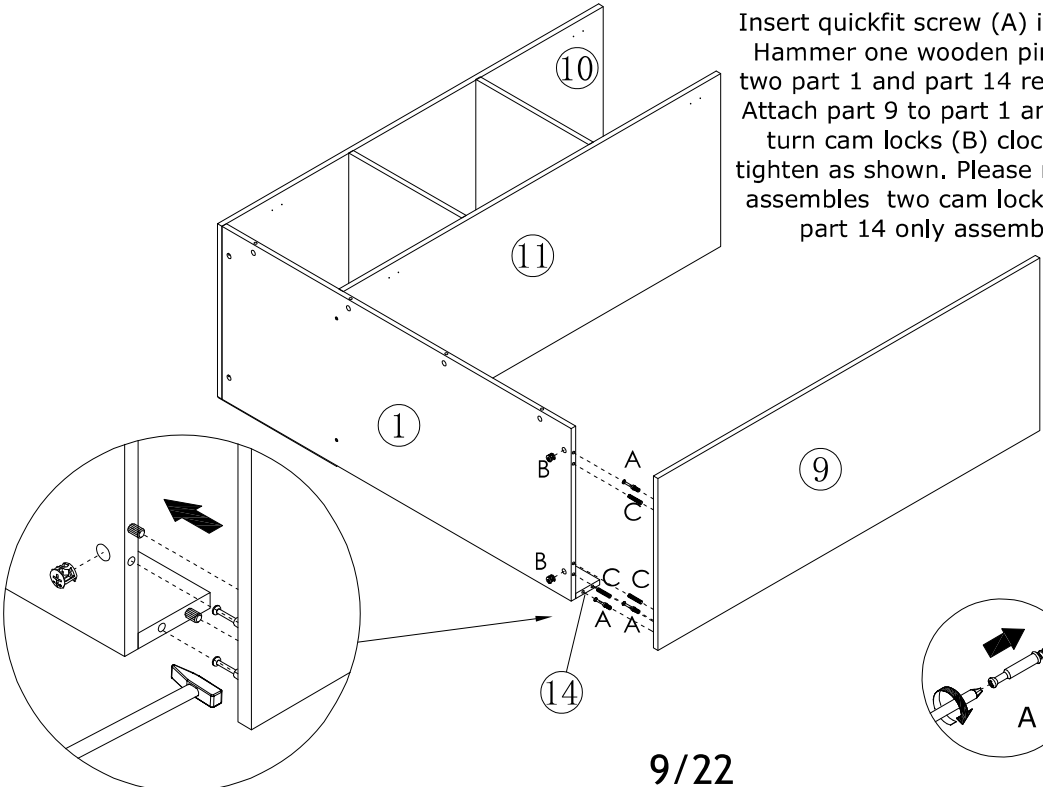

Insert quickfit screw (A) into part 9.
 Hammer one wooden pin (C) into two part 1 and part 14 respectively.
 Attach part 9 to part 1 and part 14, turn cam locks (B) clockwise to tighten as shown. Please note part 1 assembles two cam locks (B), and part 14 only assembles 1.

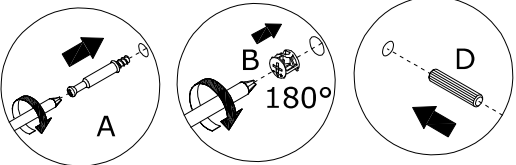
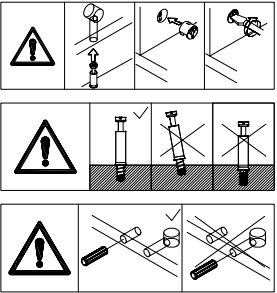

9

C x 6



∅8 x 30mm

D x 6



∅4 x 40mm

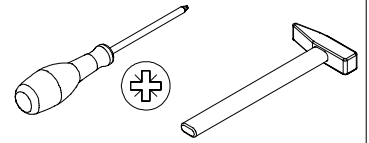

Hammer two wooden pins (C) into part 9, 10 and 11 respectively. Cover part 12 to part 9, 10 and 11 with screw (D) as shown.

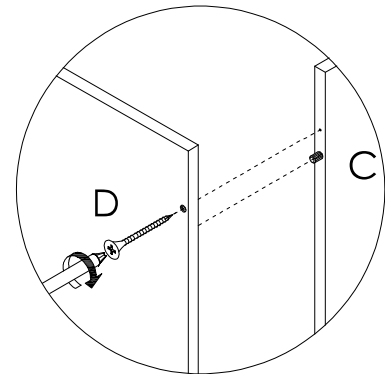
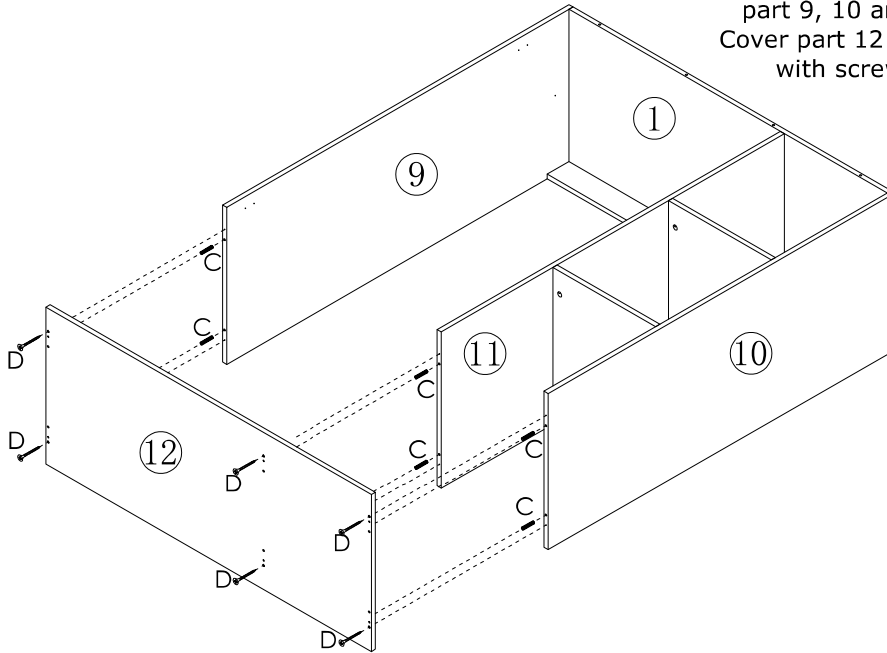
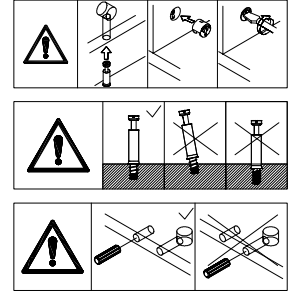

10

A x 2



∅6 x 34mm

B x 2



∅15 x 12mm

C x 2



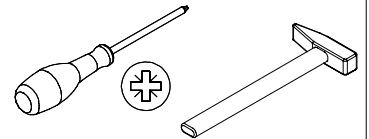

∅8 x 30mm

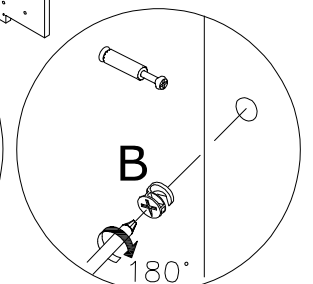
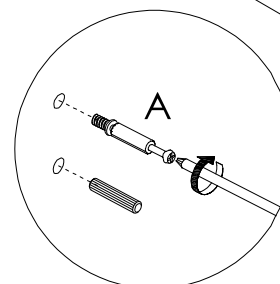
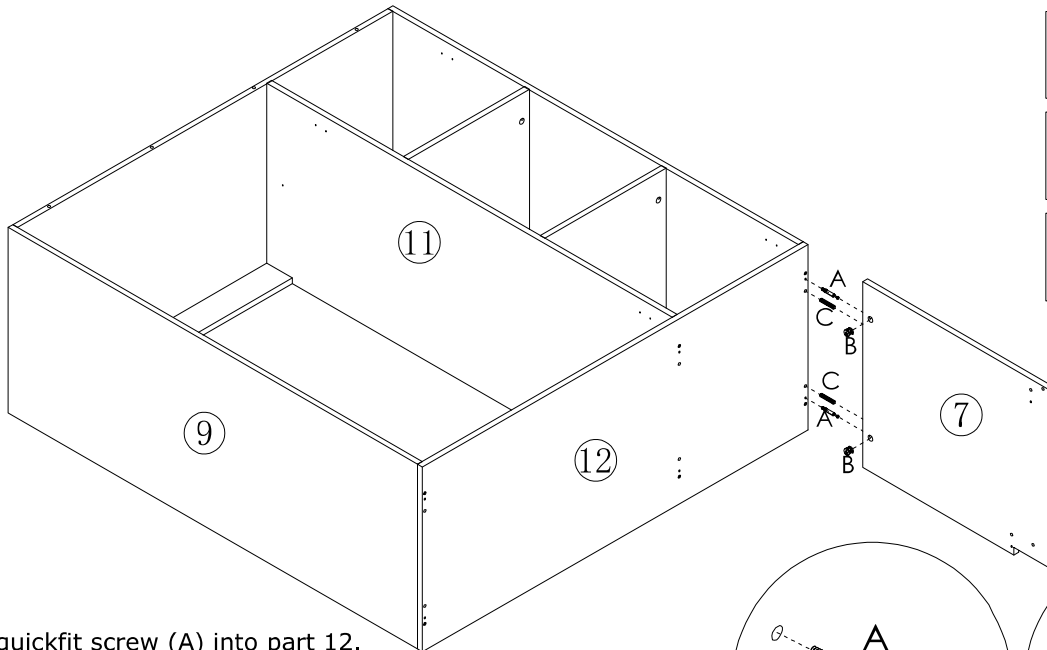
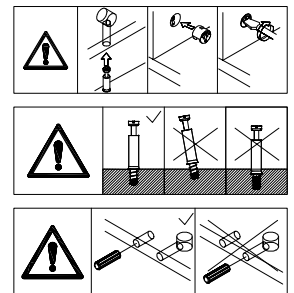

Insert quickfit screw (A) into part 12. Hammer wooden pin (C) into part 7. Attach part 7 to part 12, turn four cam locks (B) clockwise to tighten as shown.



11

A x 2  ø6 x 34mm	B x 2  ø15 x 12mm	C x 4  ø8 x 30mm
---	--	---

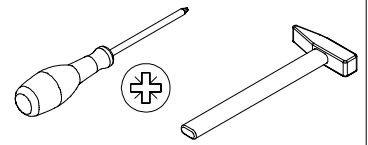

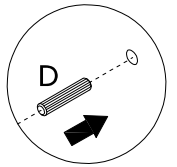
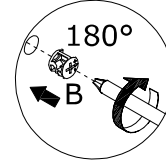
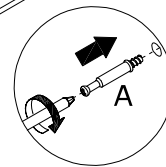
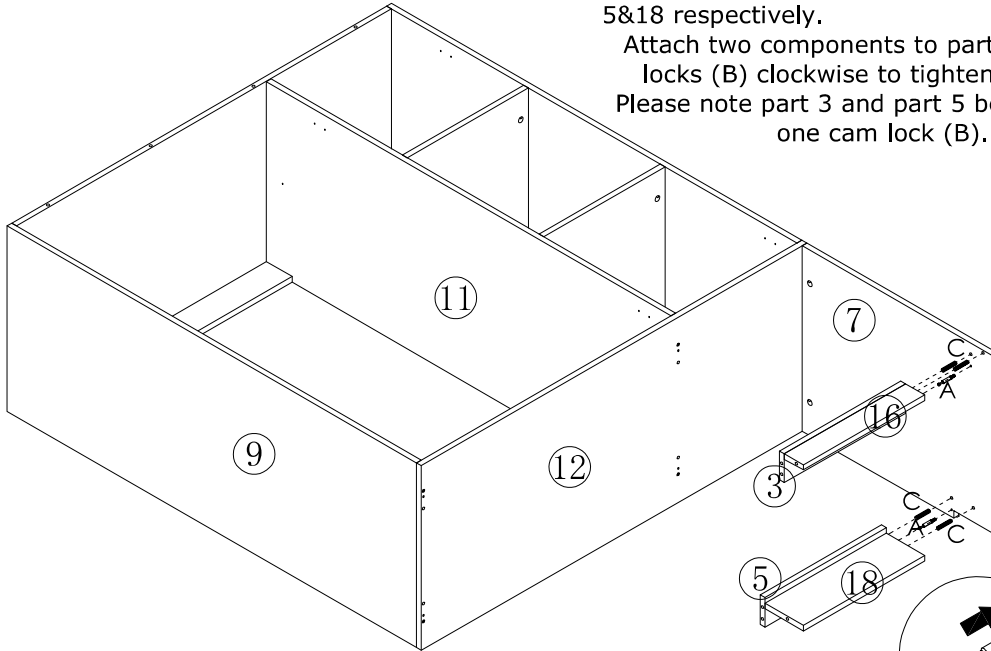
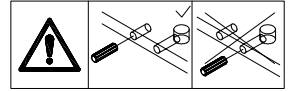
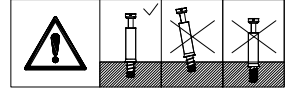
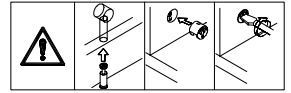

Insert quickfit screw (A) into part 7. Hammer one wooden pin (C) into part 3&16 and part 5&18 respectively.

Attach two components to part 7, turn cam locks (B) clockwise to tighten as shown. Please note part 3 and part 5 both assemble one cam lock (B).



12

A x 4  ø6 x 34mm	B x 4  ø15 x 12mm	C x 6  ø8 x 30mm
---	--	---

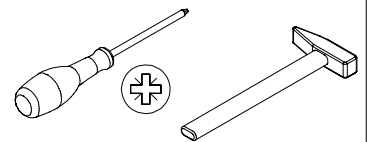



Insert quickfit screw (A) into part 8 and part 12. Hammer one wooden pin (C) into part 3&16 and part 5&18 respectively, two wooden pins (C) into part 8.

Attach part 8 to assembled unit, turn cam locks (B) clockwise to tighten as shown.

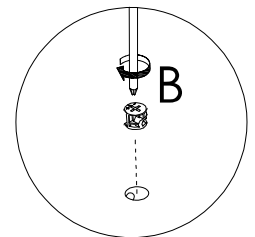
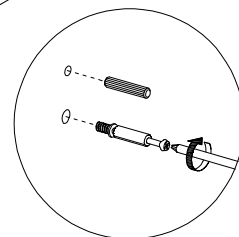
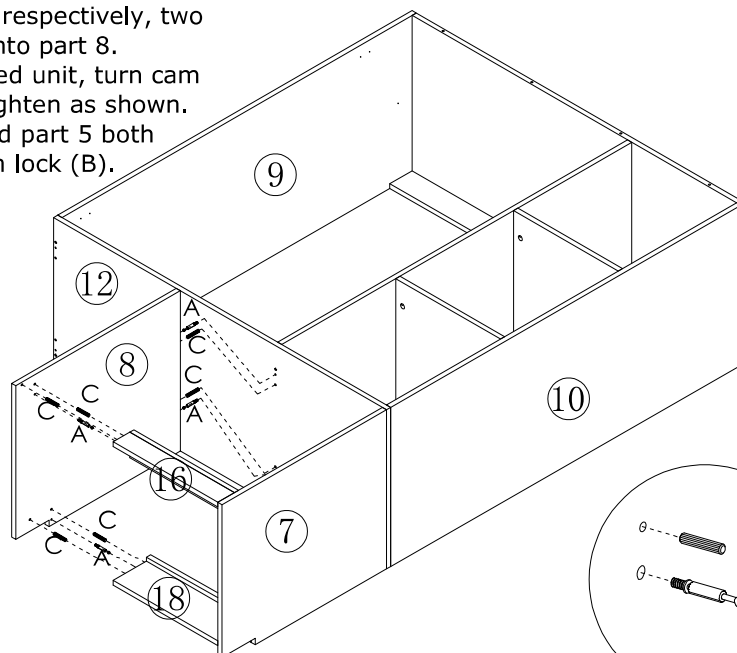
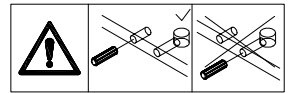
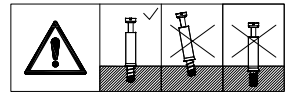
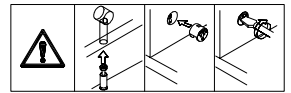
Please note part 3 and part 5 both assemble one cam lock (B).



13

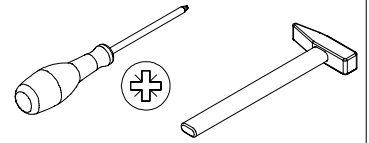

A x 2  $\phi 6 \times 34\text{mm}$	B x 2  $\phi 15 \times 12\text{mm}$	C x 4  $\phi 8 \times 30\text{mm}$
--	---	--

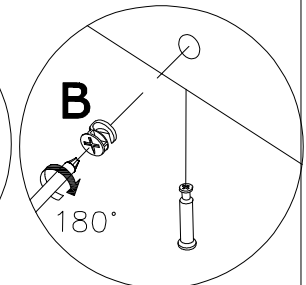
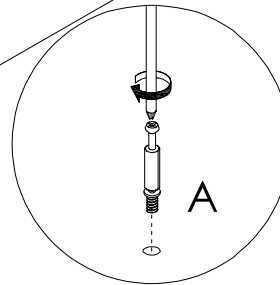
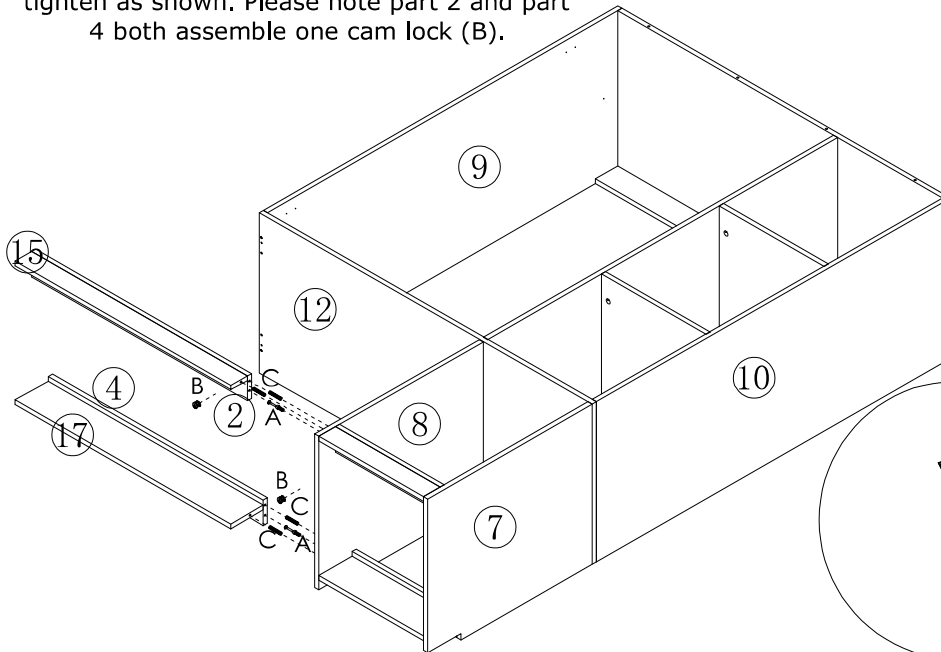
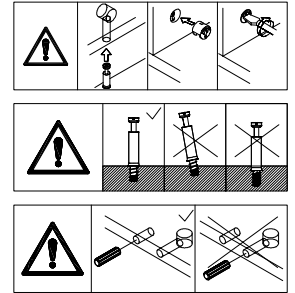

Insert quickfit screw (A) into part 8. Hammer one wooden pin (C) into part 2&15 and part 4&17 respectively. Attach two components to part 8, turn cam locks (B) clockwise to tighten as shown. Please note part 2 and part 4 both assemble one cam lock (B).



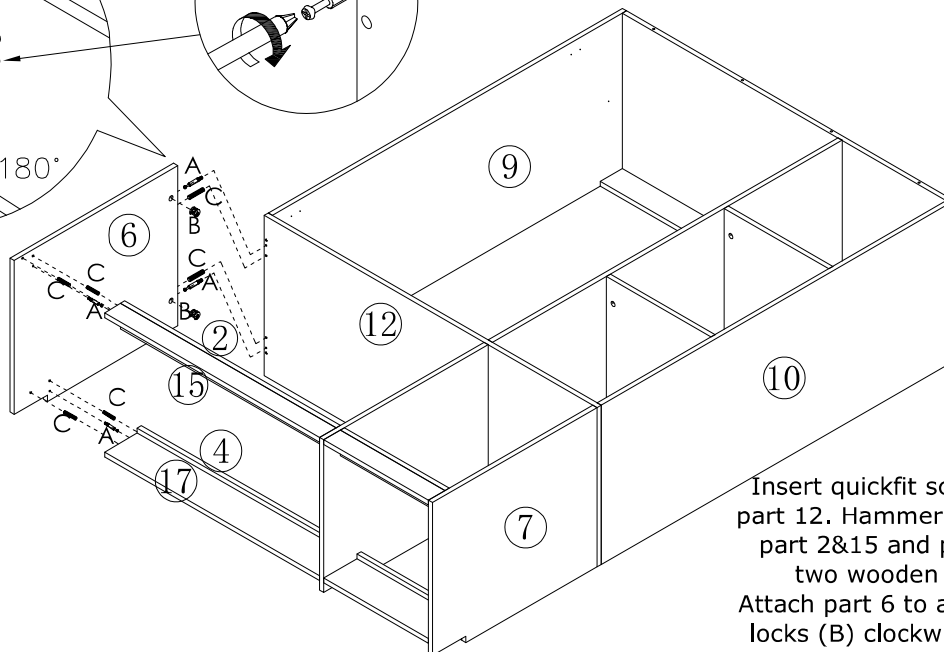
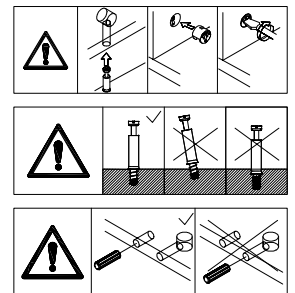
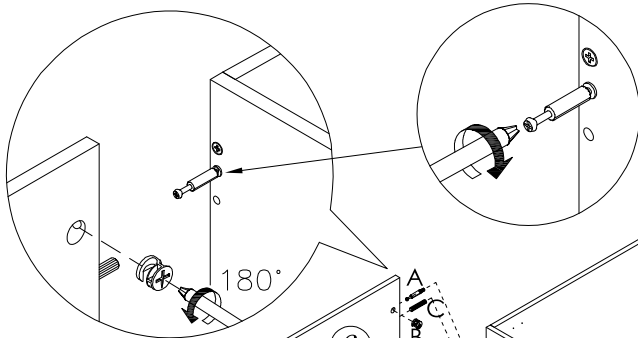
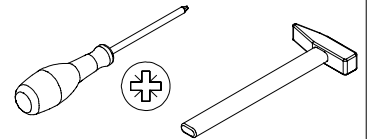

14

A x 4  $\phi 6 \times 34\text{mm}$	B x 4  $\phi 15 \times 12\text{mm}$	C x 6  $\phi 8 \times 30\text{mm}$
--	---	--



Insert quickfit screw (A) into part 6 and part 12. Hammer one wooden pin (C) into part 2&15 and part 4&17 respectively, two wooden pins (C) into part 6. Attach part 6 to assembled unit, turn cam locks (B) clockwise to tighten as shown. Please note part 2 and part 4 both assemble one cam lock (B).

15

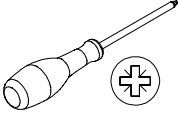
F x 34  ø3.5x 14mm	G x 11  15.5x10x1.2mm	H x 11  ø3x 16mm	
--	---	--	---

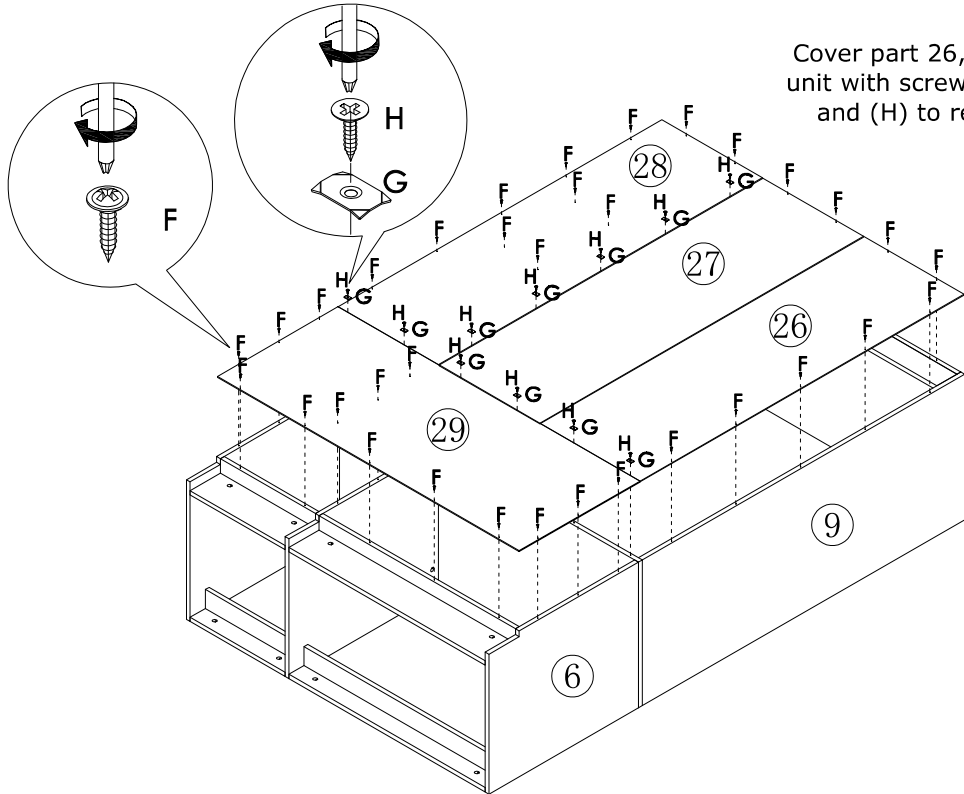

Cover part 26, 27, 28 and 29 to the unit with screw (F). And use part (G) and (H) to reinforce each panel.



16

A x 4  ø6 x 34mm	B x 4  ø15 x 12mm	
--	---	---

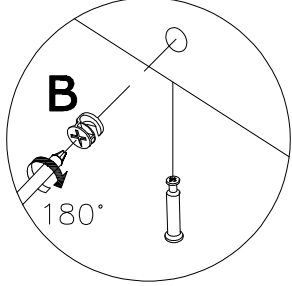
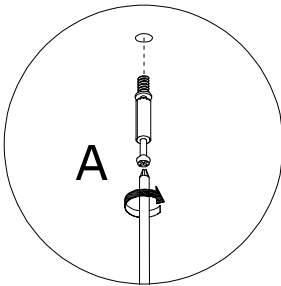
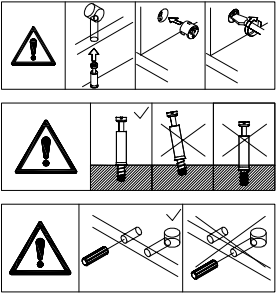
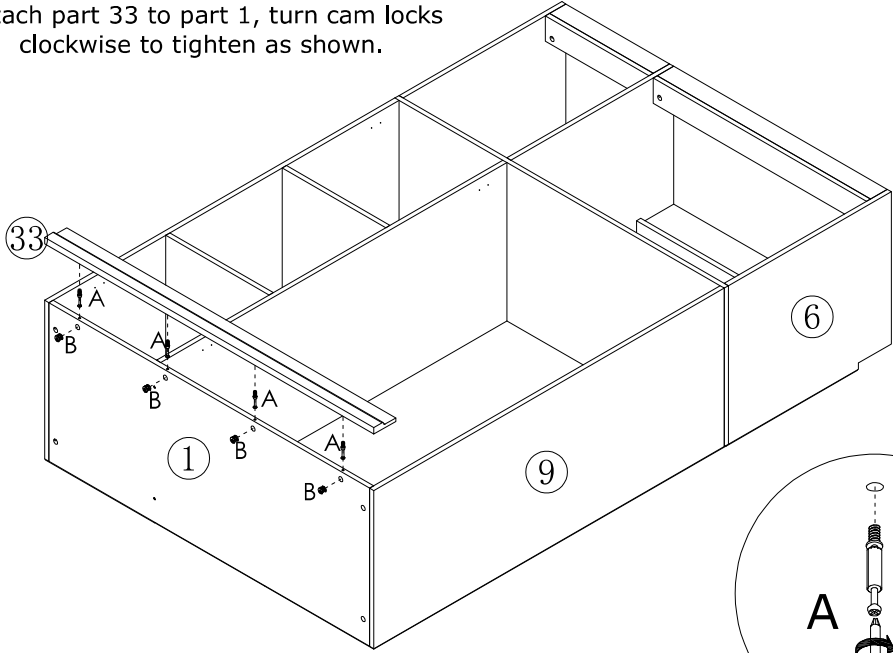
Insert quickfit screw (A) into part 33. Attach part 33 to part 1, turn cam locks (B) clockwise to tighten as shown.



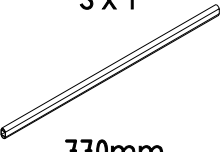

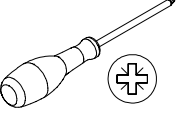
17

R x 2 	S x 1 770mm 	T x 4  φ4*14mm	
--	---	---	---

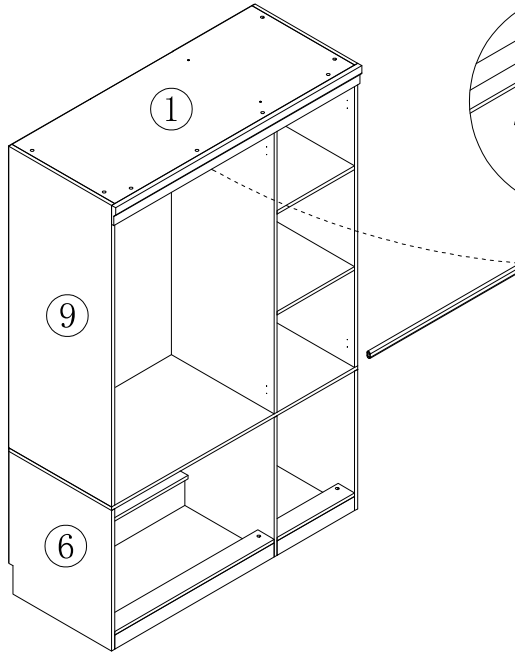
Fix part (R) to part 9 and 11 with screw (T) as shown, and put rod (S).



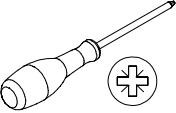

18

J x 4  φ35mm	K x 2  φ35mm	L x 12  φ4*16mm	
---	---	--	---

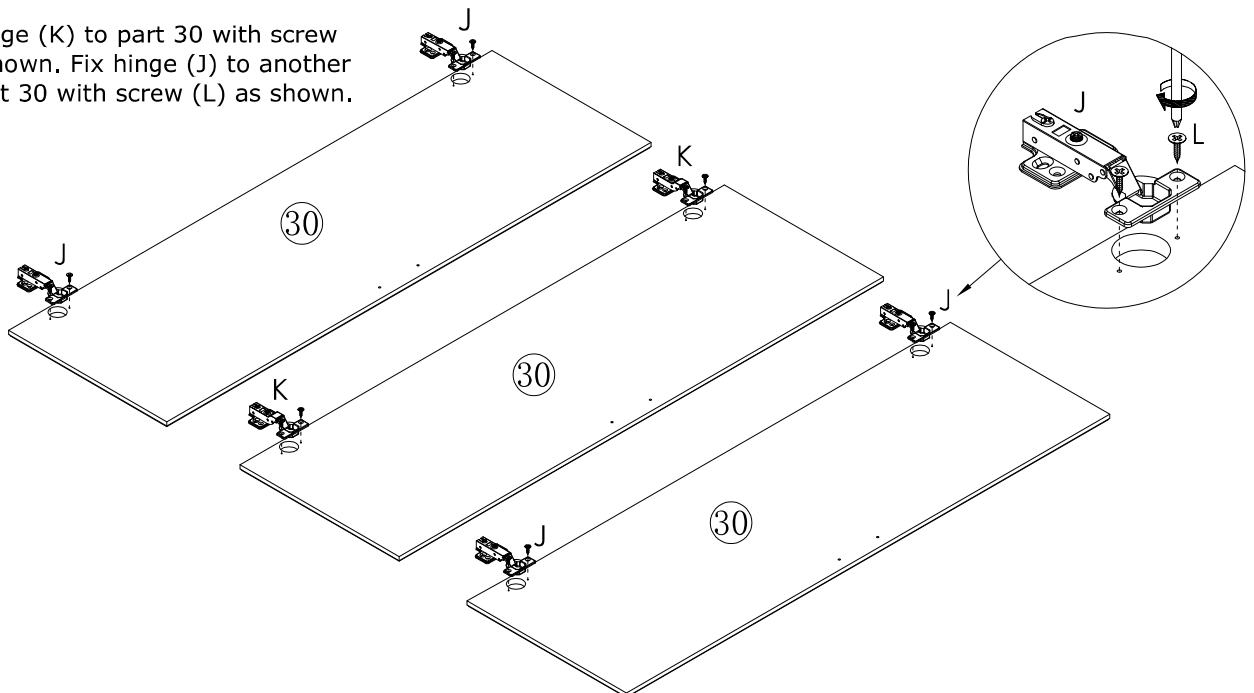
Fix hinge (K) to part 30 with screw (L) as shown. Fix hinge (J) to another two part 30 with screw (L) as shown.



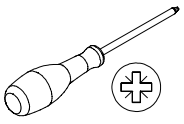

19

L x 8  φ4*16mm	M x 1  150mm	N x 2  M4 x 18mm	
---	---	---	---

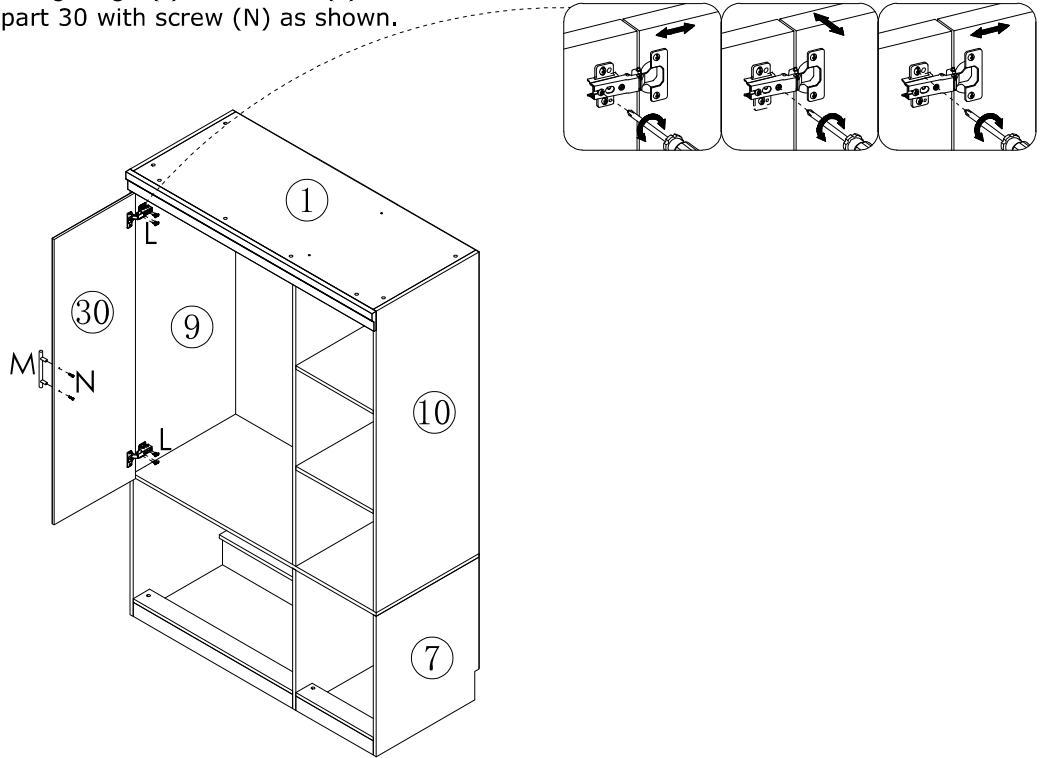
Attach part 30 to part 9, fixing hinge (J) with screw (L) as shown. Fix handle (M) to part 30 with screw (N) as shown.



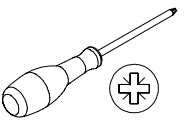

20

L x 8  φ4*16mm	M x 1  150mm	N x 2  M4 x 18mm	
---	---	---	---

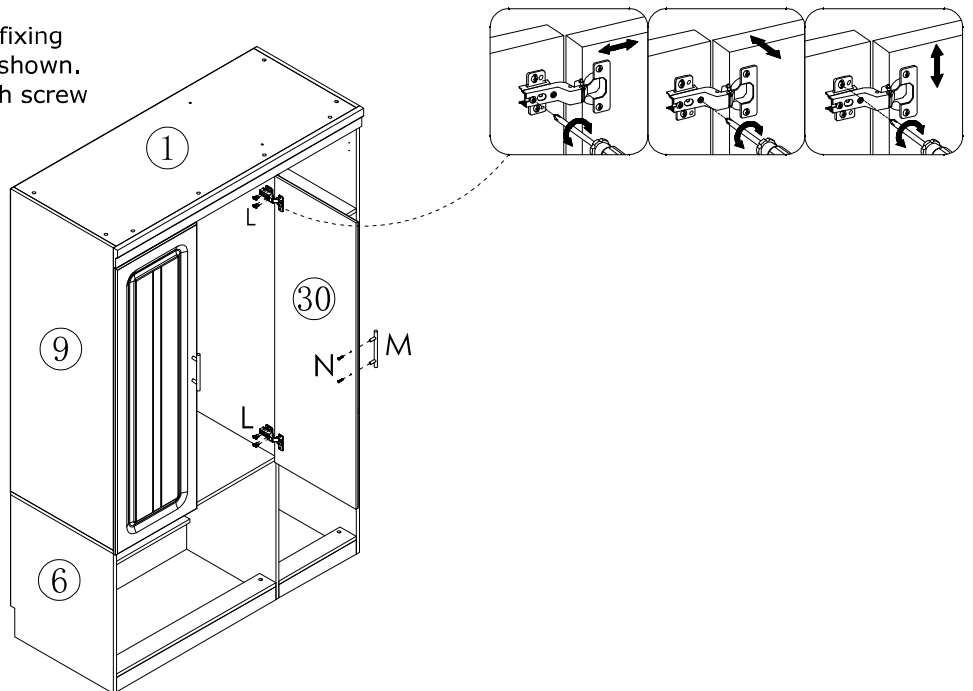
Attach part 30 to part 11, fixing hinge (K) with screw (L) as shown. Fix handle (M) to part 30 with screw (N) as shown.



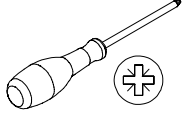

21

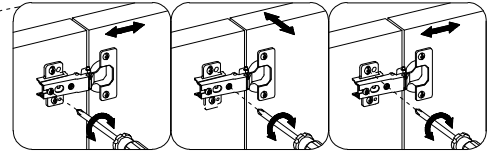
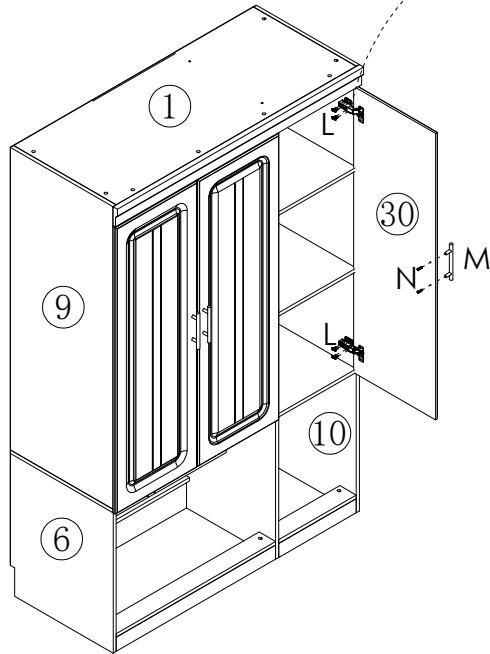
L x 8  Ø4*16mm	M x 1  150mm	N x 2  M4 x 18mm	
---	---	---	---



Attach part 30 to part 10, fixing hinge (J) with screw (L) as shown. Fix handle (M) to part 30 with screw (N) as shown.

22

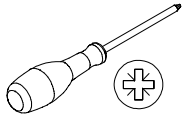
Q x 16  Ø3.5*14mm	P x 4  400mm	
--	---	---



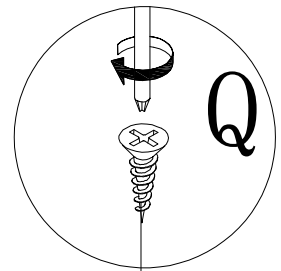
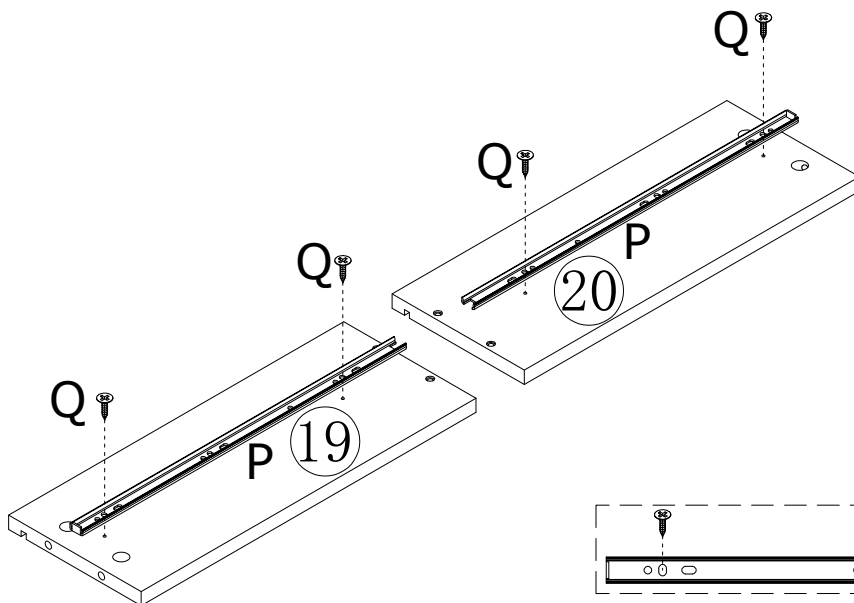

Fix runner (P) to part 19 and 20 with screw Q as shown.

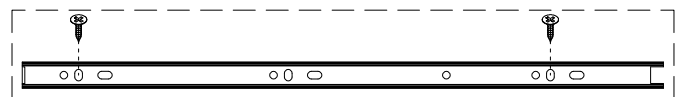

X4

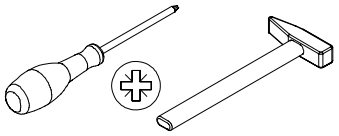

23

<p>A x 2</p>  <p>∅6 x 34mm</p>	<p>B x 2</p>  <p>∅15 x 12mm</p>	<p>C x 2</p>  <p>∅8 x 30mm</p>	<p>E x 8</p>  <p>∅4 x 30mm</p>	
---	--	---	--	---

Insert quickfit screw (A) into part 21.
 Hammer one wooden pins (C) into part 25.
 Attach part 19, 20 and 25 to part 21 with screw (E) as shown. Turn cam locks (B) clockwise to tighten part 25 as shown.

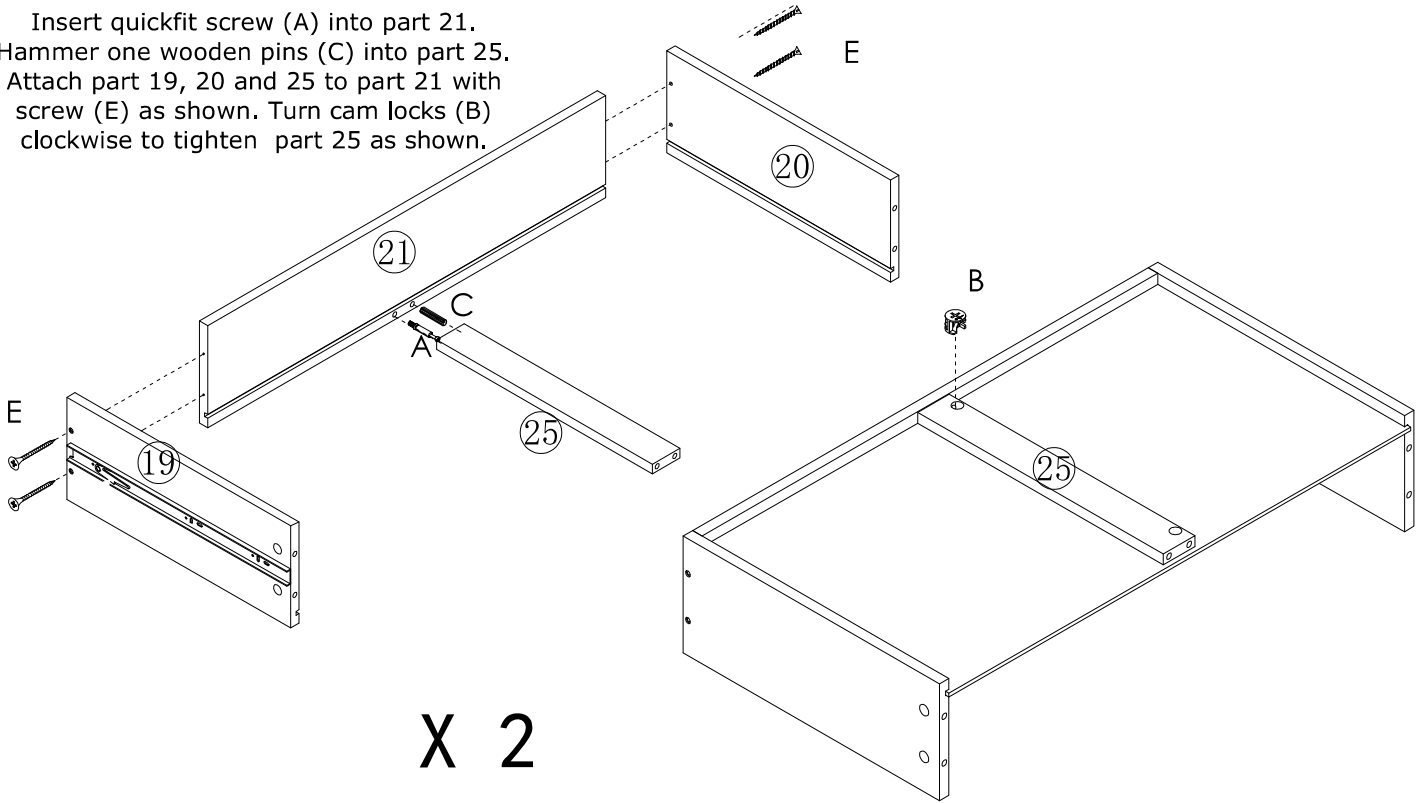

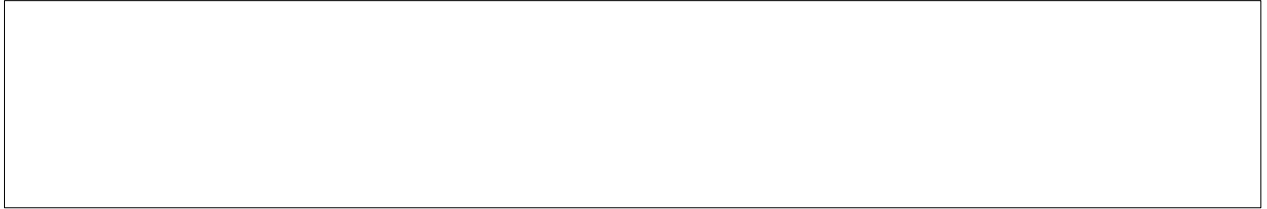

24

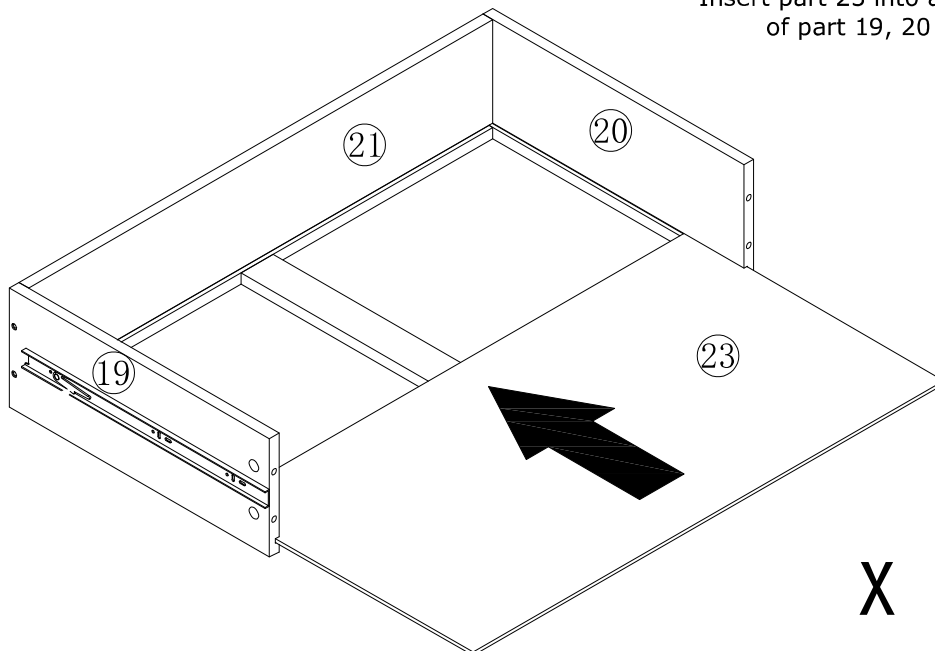

Insert part 23 into available slots of part 19, 20 and 21.



25

<p>A x 10</p>  <p>∅6 x 34mm</p>	<p>B x 10</p>  <p>∅15 x 12mm</p>	<p>C x 2</p>  <p>∅8 x 30mm</p>
--	---	---

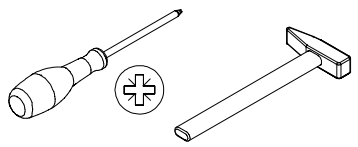

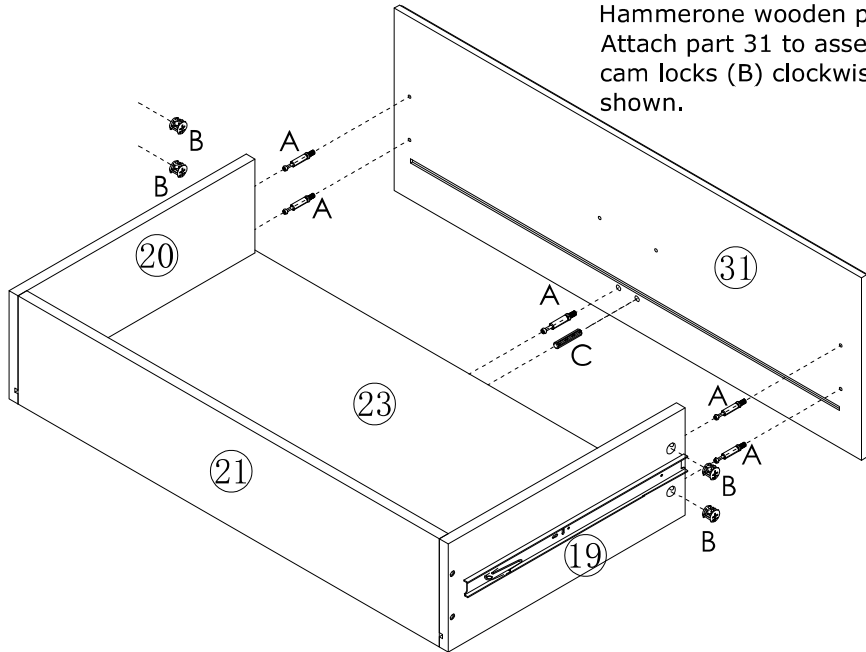
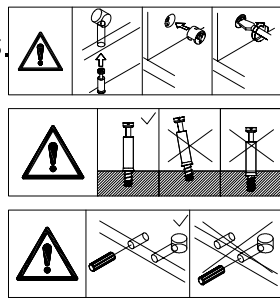

Insert quickfit screw (A) into part 31. Hammerone wooden pins (C) into part 25. Attach part 31 to assembled unit, turn cam locks (B) clockwise to tighten as shown.

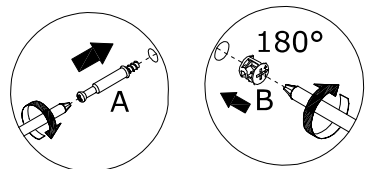

X 2



26

<p>M x 2</p>  <p>150mm</p>	<p>N x 4</p>  <p>M4 x 18mm</p>
---	---

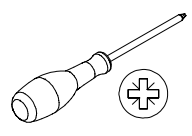

Fix handle (M) to part 31 with screw (N) as shown.

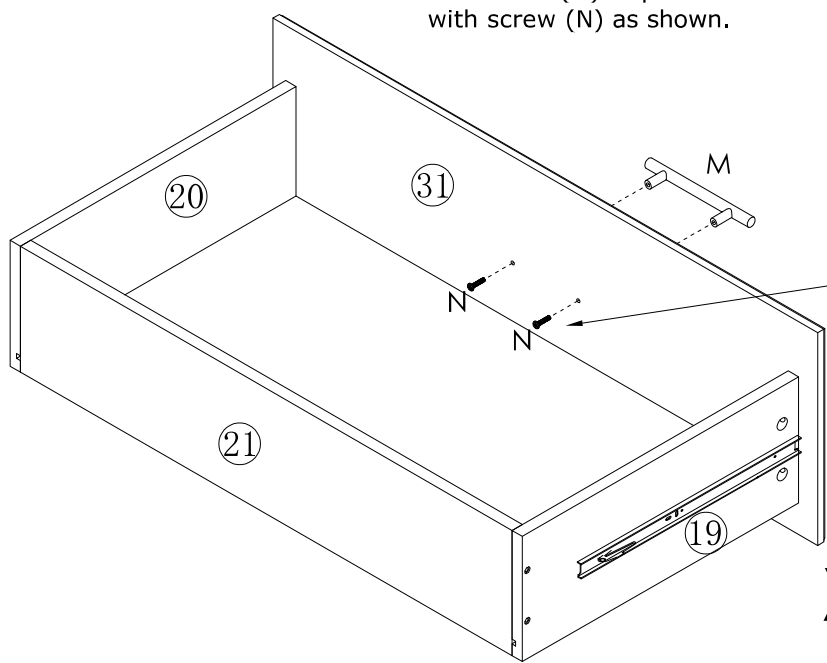

X 2

27

Ex 8  Ø4x 30mm			
---	--	--	---

Attach part 19, 20 to part 22 with screw (E) as shown.

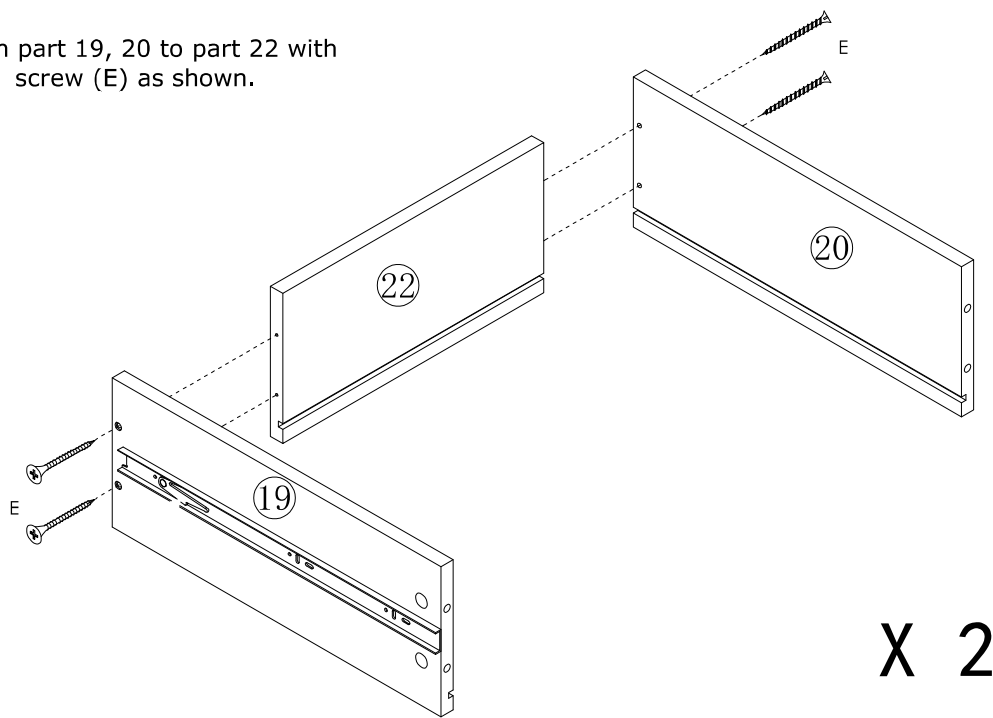



28

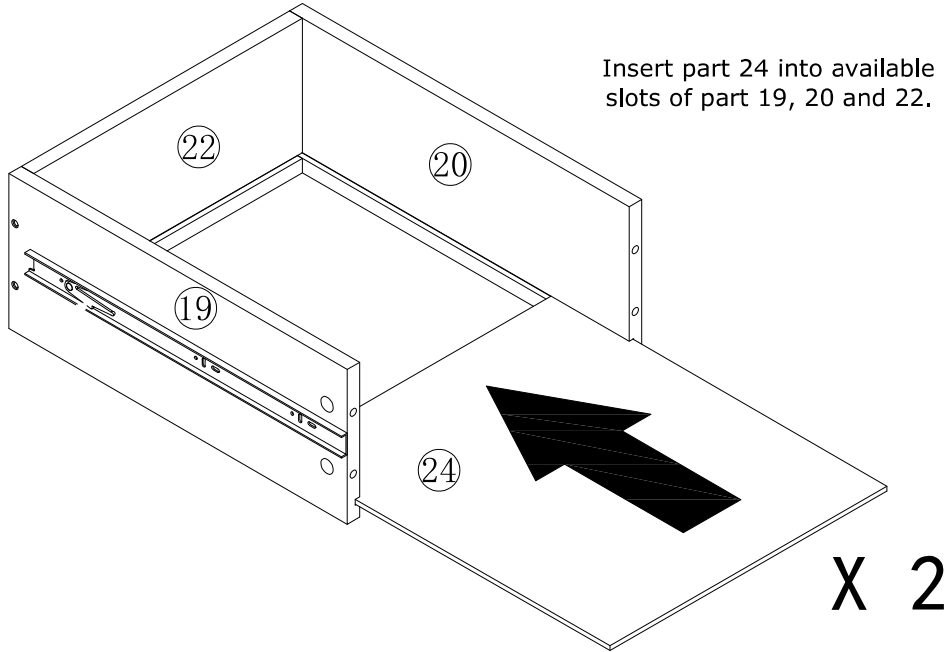

Insert part 24 into available slots of part 19, 20 and 22.



29

A x 8  ø6 x 34mm	B x 8  ø15 x 12mm
---	--

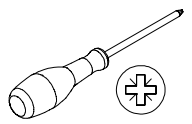

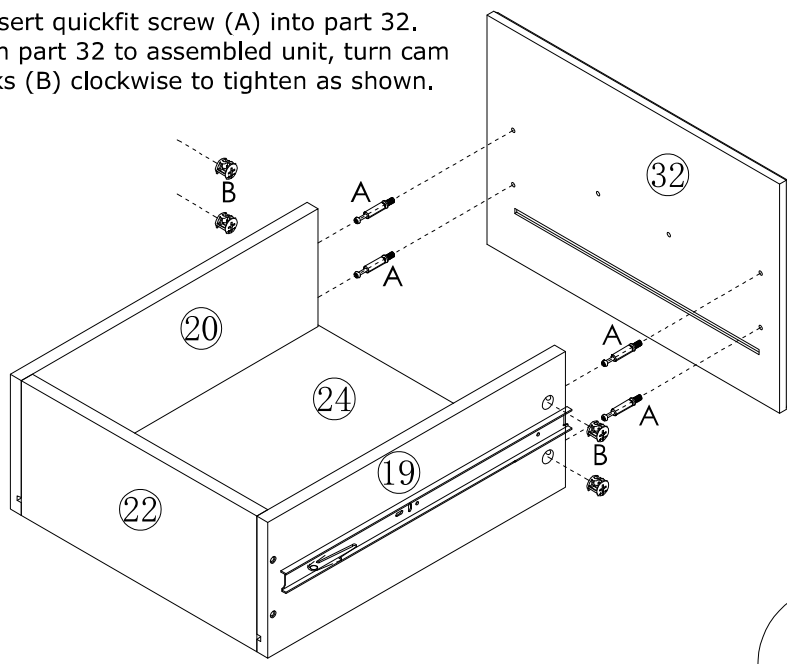

Insert quickfit screw (A) into part 32.
Attach part 32 to assembled unit, turn cam
locks (B) clockwise to tighten as shown.

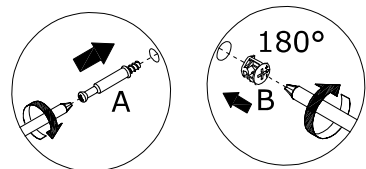
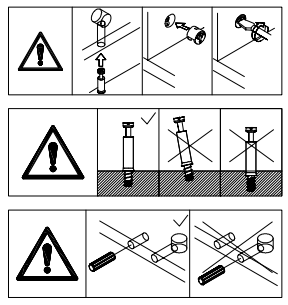

X 2



30

M x 2  150mm	N x 4  M4 x 18mm
---	---

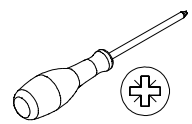

Fix handle (M) to part 32
with screw (N) as shown.

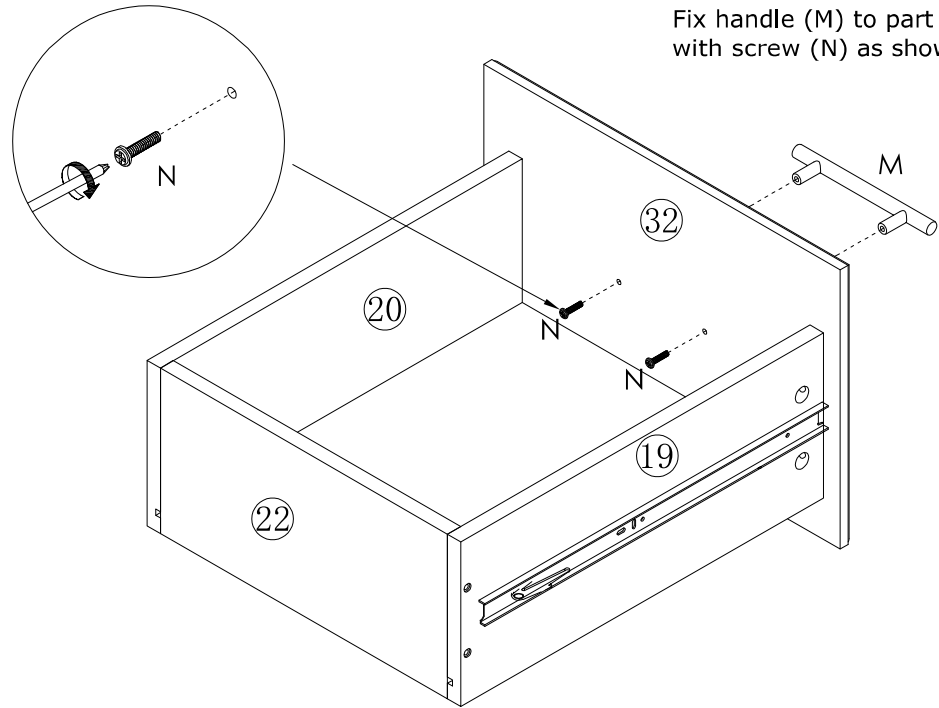

X 2

31

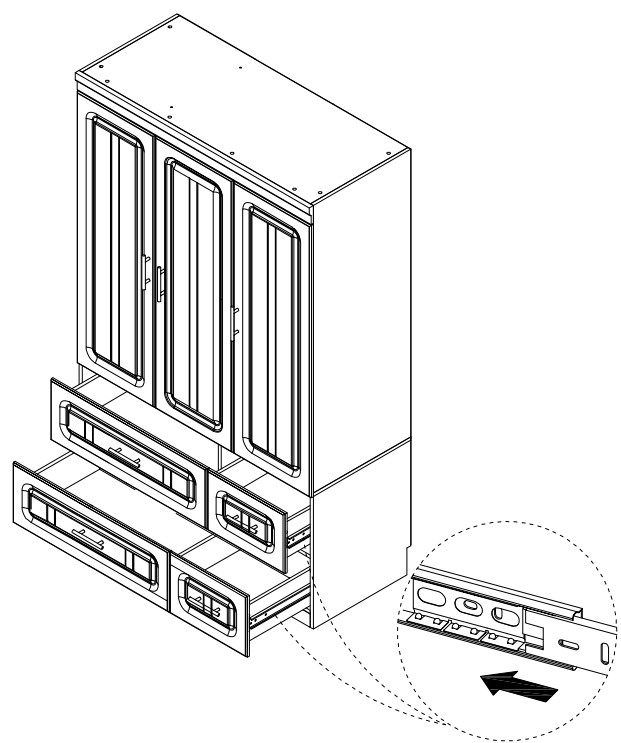
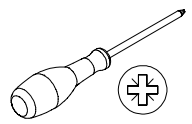

32

U x 1



1 PCS

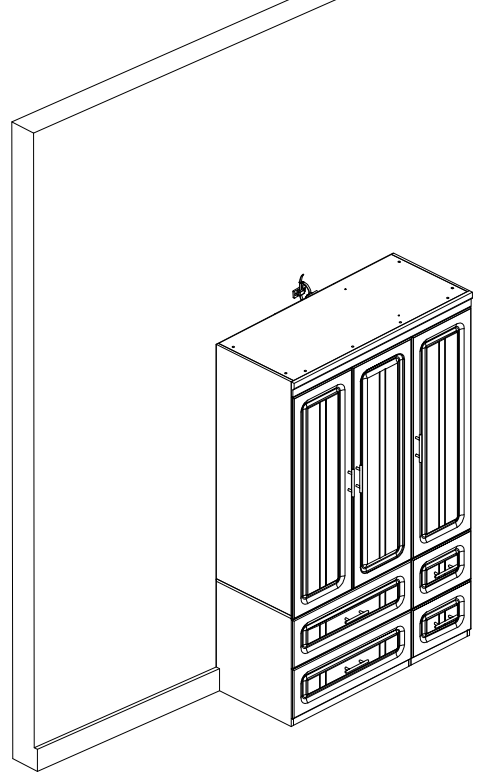
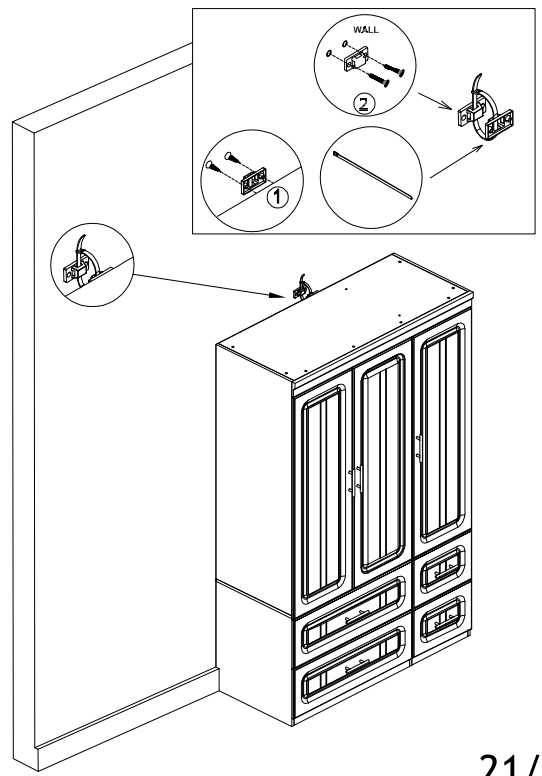
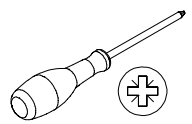
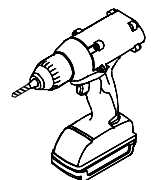
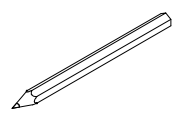

33

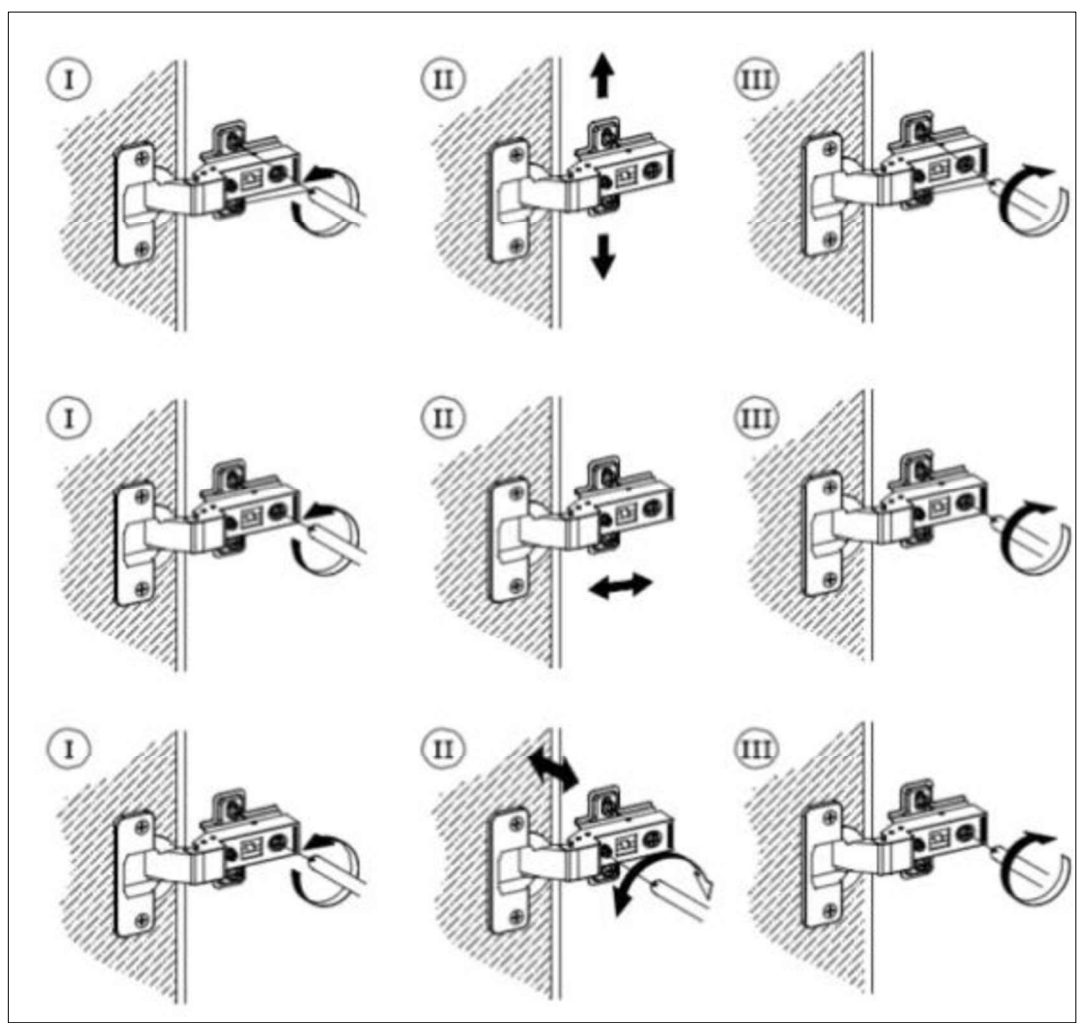
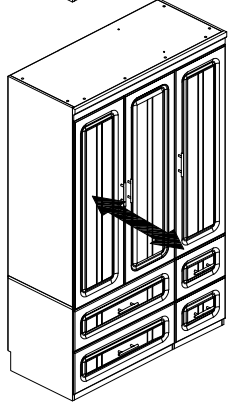
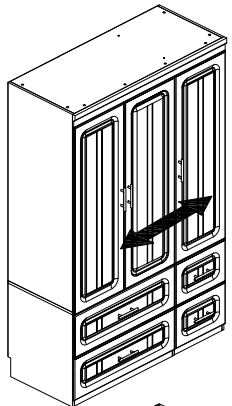
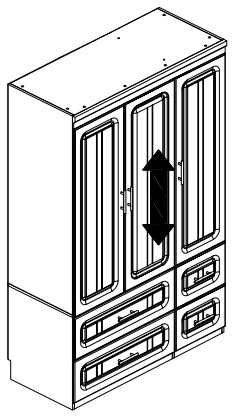
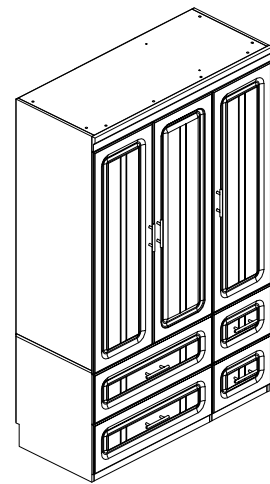
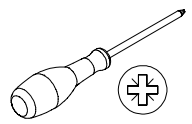

WARRANTY

WARRANTY CLAIMS

- There is a 30-day warranty for broken furniture or any other problems that do not work properly. The warranty will start from the date of purchase which must be verified by proof of purchase.
- Before making a claim, we may be able to answer your query, simply call us. Please leave your purchase order number, along with some details of the problem, if you want a replacement part. We will arrange within 48 hours. If there is out of stock, we will reply with a shipping date.
- The product must be used in accordance with the instructions provided. For health reasons.
- For other reasons, if the furniture needs to be returned, it must be cleaned and dried and operated within 30 days of receipt.

Type of Warranty Claim

- Failure to follow the furniture instructions will invalidate the warranty. Attention please.
- Does not include damage during installation, but includes damage during transportation.

Scope of responsibility

- Shall not bear any responsibility for misuse or user damage and / or loss of parts during the installation of furniture.
- After using, the damage and scratches of the furniture are not covered by the warranty.

The Warranty Relates to All Bought in The Us and Covers The Following Areas

- Sheet parts: 1 month from the date of purchase.
- Electrical parts: 1 month from the date of purchase.

RETURNS

CHANGED YOUR MIND AND NEED TO RETURN YOU ITEM?

PLEASE FOLLOW THE BELOW INSTRUCTIONS:

- If you have purchased and have simply changed your mind, follow the retailer's instructions for returns.

DEFECTIVE ITEMS

- If your item is defective in any way, i.e. it doesn't work but you can't identify why, in the first instance, please consult our FAQ section at feedbackstation@163.com as there may be a simple solution to the issue.

DAMAGED ITEMS

- If you receive an order with obvious shipping damage from the retailer, then we suggest the delivery is refused. If the delivery has been accepted and then shipping damage is found, please follow the specific instructions advised by the retailer.
In all circumstances please save all packaging material and paperwork for the order. Please be aware that if you dispose of packaging material or attempt to return the merchandise without contacting the fulfiller, you jeopardise your chances of making a claim, and you may not receive a credit for the return.