



FREESKY®
go anywhere

USER MANUAL
26" WILD CAT ELECTRIC BIKE





FREESKY
go anywhere

YANSHAN Technology Co., LTD

Contact us if you experience issues relating to riding
Maintenance and safety, or errors/faults with your FREESKY e-bike

 [https:// www.freeskycycle.com](https://www.freeskycycle.com)

 support@freeskycycle.com

 <https://www.youtube.com/@freeskyebike>

 <https://www.facebook.com/groups/freeskyebike>

 611 Reyes Dr. City of Industry Walnut CA 91789



Wild Cat Mountain e-Bike



Words to Users

Thank you for choosing Freesky! In order to make it easier for you to experience the product and be safe at riding, detailed instruction is provided, from which you can find the product's instruction, usage and other information. Before using this product, please read the manual carefully so that you can correctly use it.

Please record your bicycle's serial number in the space below. The serial number is located on the head tube of your bicycle. Refer to page 3 for the location of the serial number.

Serial Number: _____

Contents

User Precautions	01
Package List	02
Product Overview	03
Assembly	04
Battery	13
Start-Up Procedure	18
Display	19
Before your first ride	23
Daily care and Maintenance	24
Troubleshooting	30
Specifications	32
FAQS	33
Warranty	34
Disclaimer	36
Refund policy	37



Product Safety Notice



To prevent **PROPERTY DAMAGE, SERIOUS INJURY, or DEATH**, you should read, understand, and follow the instructions below:



Always wear a helmet when riding your electric bike.



Keep the two keys properly. If the unique keys are lost, you will not be able to turn on the bike or replace the battery. If necessary, you should get more spare keys. (We don't have a backup key)



Make sure your electric bike has a full battery before taking it out to ride.



Always respect pedestrians.



Your electric bicycle can withstand light rain and small splashes, but it is not designed to be subjected to inclement weather, extremely heavy showers, or submersion in water. The electric bike's components have an IP rating of 65. Water damage is not covered under the warranty



Walk the bike in PAS 0 after the bike is powered on to avoid sudden acceleration.



When stopping the bike, **ALWAYS** apply right brake lever (rear wheel) before and during use of the front brake. **ALWAYS** apply even pressure to both brake levers when slowing down or stopping. If only the front brake is applied while slowing or stopping quickly, you may be ejected over the front handlebars.



Always be aware of local road laws, and follow them.



Package List

Carefully check package contents, if anything is missing or damaged, please contact Freesky customer service : support@freeskycycle.com



1x User Manual



2x Pedals



1x Front Wheel Screws



1x Front Wheel



1x Saddle



2x Wrench
7x Allen Key Wrench



2x Keys



1x Charger



1x Electric Bike



Product Overview





Headstock Assembly

1



1. Loosely secure the top of the faceplate.

2



2. Insert the handlebar into the locknut on the stem.

3



3. Center the handlebar and adjust the direction, make sure the handlebar is centered on the stem.

4



4. Use the wrench to tighten the screw and fix the handlebar stem in place.



Front Wheel Assembly

1. Remove the Red protection piece from the caliper of the brake.
2. Align the disc between the brake caliper as shown in Figure 1.
3. Insert the front wheel in between the front fork on the bike. Be sure the fork is resting on the outside of the axle.

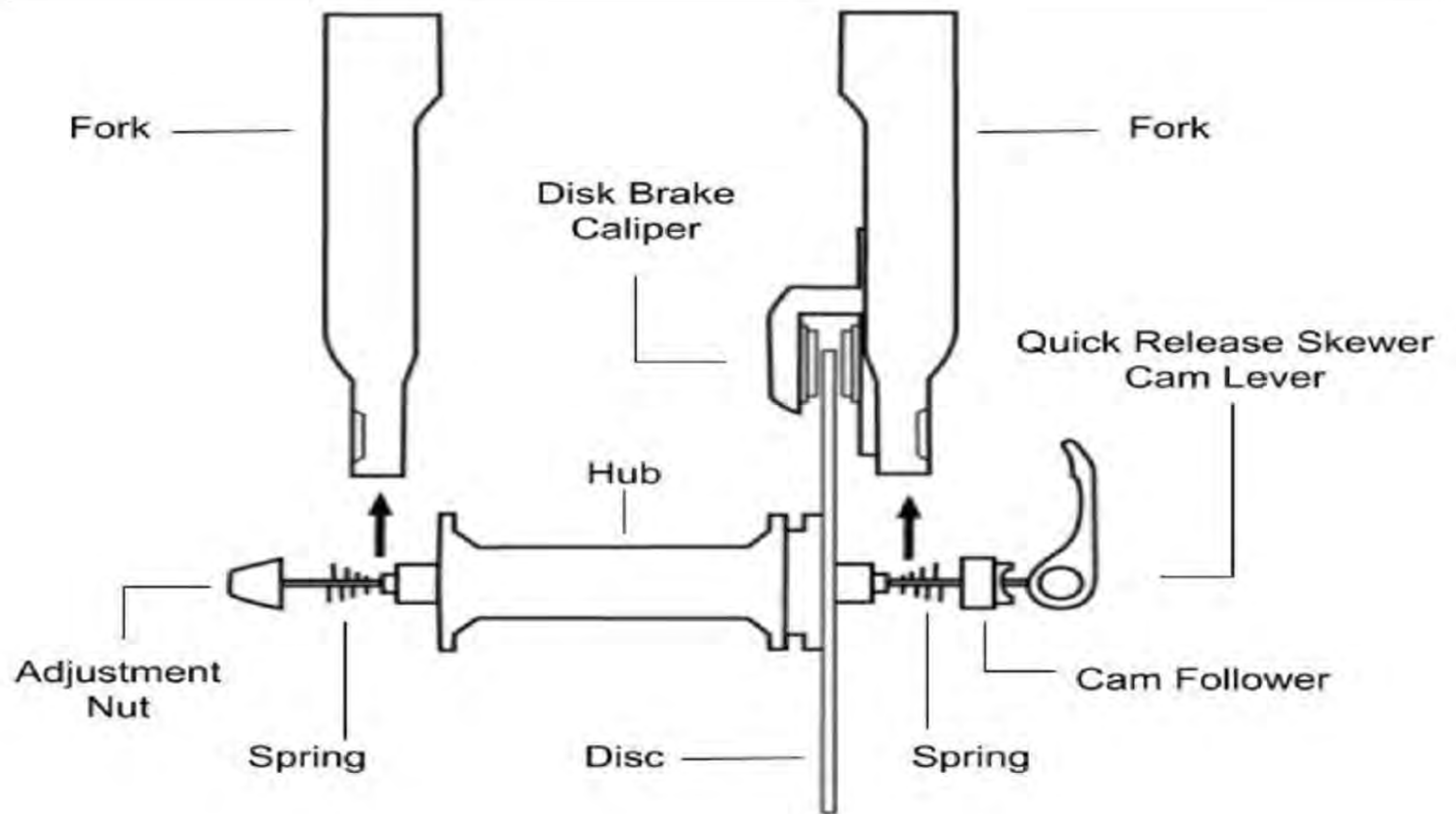

4. Insert the skewer into the wheel axle as seen shown. Keep the spring, cam follower and lever on the LEFT side, nearest the disc brake. Keep the adjustment nut and spring on the RIGHT side. (See Figure 2)

Figure 2

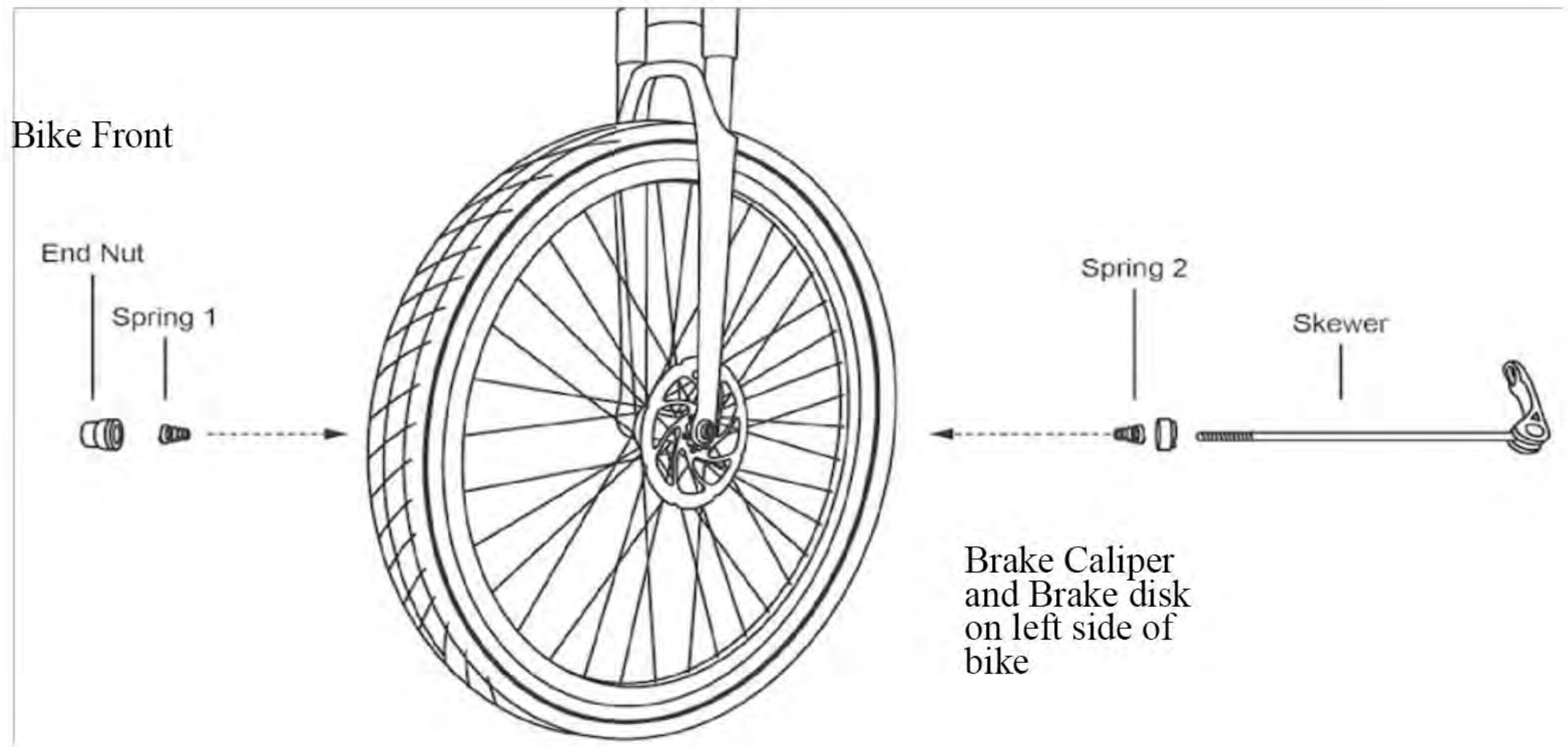

4. Screw the skewer into the end nut until almost tight.

5. Lift the lever up until parallel with the front fork. You should feel the axle tighten into the front forks. Your front wheel is now installed.



Front light Assembly

1



1. Put the headlight on the arch of the fork.
Locate the bolt hole.

2



2. Fix the nut and tighten the bolt.

3



3. Connect the yellow headlight cable.
(Pay attention to the Arrow mark on the cable).

Click this link to watch cable connection video:<https://youtu.be/WOrH8cbQgQk>



Saddle Assembly

For better pedaling, safety and overall riding comfort, positioning the seat at the right height is important. The rider's leg length is used to determine the seat's position. When you pedal, your hips should remain level and your legs should be almost fully extended at the bottom of the pedal stroke, but not over-extended. To determine the right seat height, sit on the e-Bike with one pedal at its lowest point and place the ball of your foot on the pedal. Your leg should be almost fully extended(not locked out) with a slight bend at the knee.

1



1. Open the quick release lever by swinging the lever open and outward fully.

2



2. Move the seat up and down by sliding the seatpost in or out of the seat tube. DO NOT raise the seatpost beyond the minimum insertion marking etched into the seatpost tube.

3



3. Adjust the seat and the head of the seat is parallel with the top tube.

4



4. Close the quick release lever using your palm or finger.



Saddle Adjustment

Adjusting the Seat Position and Angle

To change the angle and horizontal position of the seat:

- (1) Use an Allen wrench to loosen the seat adjustment bolt on the clamp positioned immediately underneath the seat, above the rear wheel.

Do not remove the bolt fully.

- (2) Move the seat backward or forward and tilt to adjust the angle. A seat position horizontal to flat ground is desirable for most riders. Do not exceed the limit markings on the seat rail, which show the minimum and maximum horizontal movement allowed.
- (3) While holding the seat in the desired position, use an Allen wrench to tighten the seat angle adjustment bolt securely to the recommended torque value.



Prior to first use, be sure to tighten the seat clamp via the seat adjustment bolt properly. A loose seat clamp or seatpost adjustment bolt can cause damage to the bike, property, loss of control, a fall, serious injury, or death. Regularly check to make sure that the seat clamp is properly tightened.



Suspension Fork Adjustment

Adjusting the Suspension Fork

The suspension fork can move up and down up to 80mm to cushion bumps in the riding surface, which can make riding on a rough road or trail smoother and more comfortable. Depending on a rider's preference, the suspension fork can be locked out as a rigid fork, which will typically yield higher efficiency while pedaling.

The preload adjustment knob (1), located on the top of the left side of the suspension fork. To soften the ride, subtract resistance by turning the preload adjustment knob counterclockwise, in the direction of the small " - " on the knob. To make the suspension stiffer when going over bumps, add resistance by turning the preload adjustment knob clockwise, in the direction of the small " + " on the knob.

The lockout lever (2), located on top of the right side of the suspension fork, can be turned counterclockwise until it stops to completely lock out the suspension fork's travel. To unlock the lockout lever, turn the knob clockwise until it stops. When the lockout lever is unlocked, resistance can be adjusted by turning.





Pedals Assembly

1. **Warning:** Incorrect installation will cause damage. Please read the instructions and watch our videos if needed. YouTube link: <https://youtu.be/a3FPtAbtFiY>
2. Identify the Left and Right markings on the pedals. They can only be installed in their respective side.
 - a. L is for the Left Pedal and it goes on the Left Crank Arm.
 - b. R is for the Right pedal and it goes on the Right Crank Arm (Chain Side)

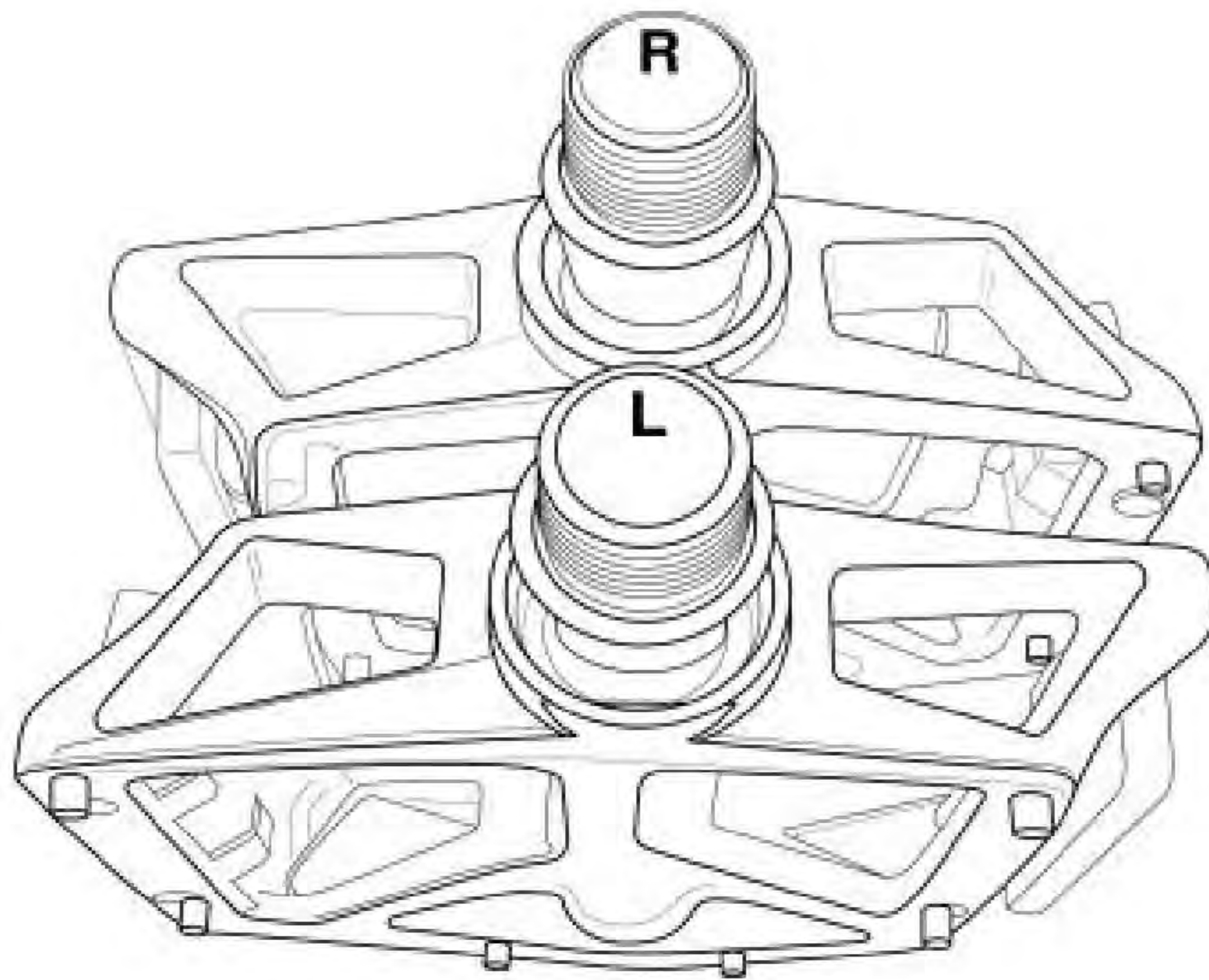

3. Sitting on your bike the pedals go on the Left and Right side respectively.
4. Keep the pedal Horizontal while hand screwing to get the thread started. Then Use your 15mm wrench to tighten them.
5. Both pedals tighten towards the front of the bike. The left pedal is reverse threaded to allow this.
6. The pedals need to be very tight, be sure to retighten after your first couple rides.

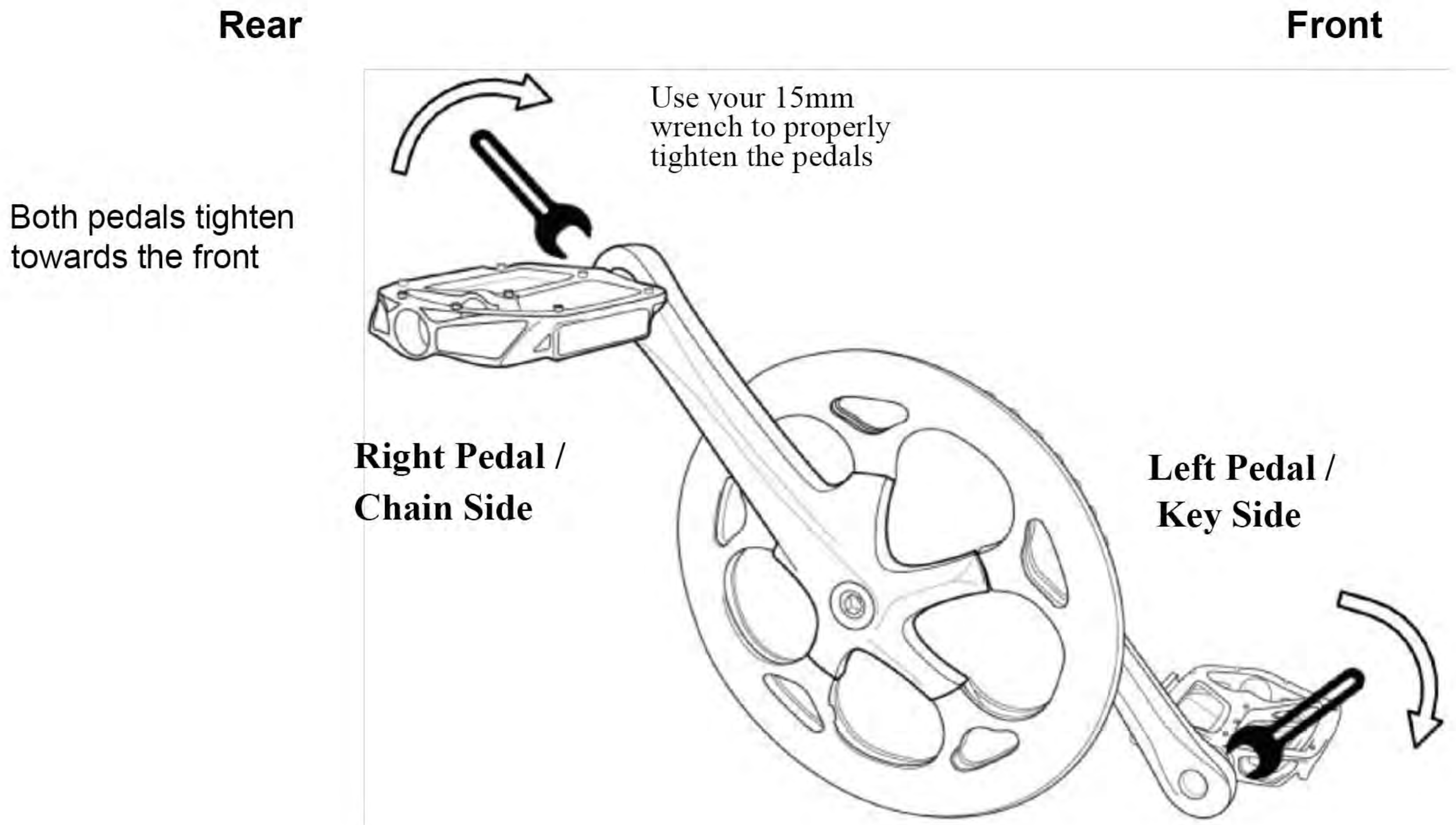



Battery on Downtube



Battery Charging Port



Battery Power Button



Battery Removing Switch

1. Familiarize yourself with the key port and battery power positions before riding the bike. The photo shows the key port aligned in key position 1, in line with the small lock icon. In key position 1, the battery is in the "lock" position, with the battery locked to the frame, and the key removed so the bike is ready to ride.

2. Anytime the battery is in key position 2, (off, unlocked from the frame) the battery must be removed from the bike before moving or riding the bike. Hold the battery and turn the rotary switch to the right to remove the battery.





Take out of the batteries

For your convenience, the Freesky battery can be removed.



1. Ensure the bike is off. Align the key port with the appropriate off position by inserting the key into the keyport and rotating to align the key with the off icons.



2. Carefully hold the battery and remove it from the frame. Note: the battery has some weight and should be handled with care.



Charge the Battery on the Bike

Before using the electric bike, you must fully charge the battery.



1. Remove the rubber cover on the place of charging port of the battery.
2. Plug the charger into the battery's charging port. With the battery on or off the bike, place the charger in a flat, secure place, and connect the DC output plug from the charger to the charging port on the side of the battery.
3. Plug the charger into a power outlet, charging should initiate and will be indicated by the LED charge status lights on the charger turning red. Once fully charged, the charging indicator light turning green. Unplug the charger from the wall outlet first and then remove the charger output plug from the battery charging port.
4. Unplug the charger from the wall outlet first and then remove the charger output plug from the battery charging port.



Charge Your battery off the bike



1. The battery can be charged off the bike. To remove the battery, carefully hold the battery before turning the key to the " unlock " icon in case the battery drops on the floor.







2. Plug the charger into a power outlet, charging should initiate and will be indicated by the LED charge status lights on the charger turning red. Once fully charged, the charging indicator light turning green. Unplug the charger from the wall outlet first and then remove the charger output plug from the battery charging port.



Start-Up Procedure

After the bike has been properly assembled according to the assembly video, all components are secured correctly, a certified, reputable mechanic has checked the assembly, and you have read this ensure manual, turn on the bike and select a pedal assist level following the steps below:

1. Turn on the bike. With the battery locked in place. Locate the LCD display controller (near the left handlebar grip). Hold down the  button for approximately 2 seconds until power is delivered to the LCD display and turn on.
2. Turn on the front light if needed or desired. Once the battery is on, long press  button.
3. Select the desired level of pedal assistance (PAS) between level 0 through 5 using the  and  on the display controller. Level 1 corresponds to the lowest level of pedal assistance, and level 5 corresponds to the highest level of pedal assistance. Level 0 indicates pedal assistance is inactive. Start in PAS level 0 or 1 and adjust from there.
4. Begin riding carefully. With the proper safety gear and rider knowledge, you may now operate your bike. On a flat surface, in a low gear (1 or 2), most riders should be able to begin pedaling the bike with pedal assist level 0 or 1. You may also use the throttle to accelerate and maintain your desired speed.
5. The throttle is used by slowly and carefully rotating the throttle backward toward the rider. Do not use the throttle unless you are on the bike.



Do not use the throttle while dismounted. Avoid accidental application of the throttle while dismounted; anytime you are moving the bike while dismounted, ensure the bike is powered off to prevent accidental application of the throttle.



Display Details

1. Display Areas

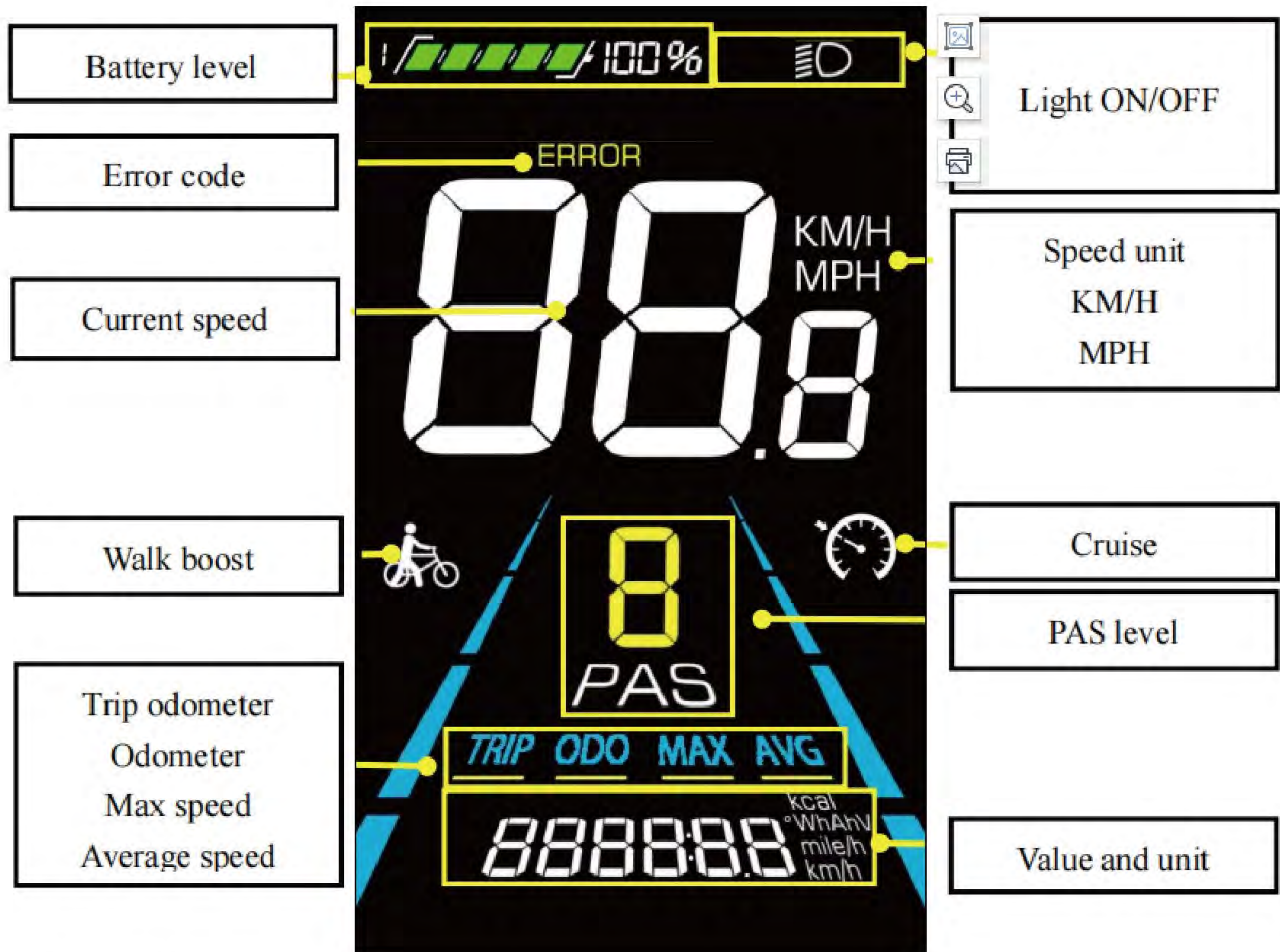





2. Functional overview

The display offers a variety of features to suit your riding needs, including:

- Battery level indicator
- Pedal assist (PAS) level indicator
- Speed (current speed, maximum speed, average speed)
- Mileage display (single and total mileage)
- Walk boost mode
- Light ON/OFF
- Error code indicator
- Motor power indicator (optional)
- USB connection indicator (optional)
- Cruise control indicator (optional)
- Bluetooth connection indicator (optional)
- Personalized parameter settings (e.g. wheel diameter, speed limit, battery power setting and PAS parameter setting, password setting, controller current limit setting, etc.).
- Factory default parameter recovery function

3.Control Button definitions



The display is equipped with five buttons on the corresponding operating unit: power on/off , plus , minus , light  and toggle .

4.Routine operation

4.1 Power on/off

Long press  to power on/off the display. When the display is off, it will not use the battery power and the leakage current is less than 1uA.



The display will automatically shut off if it is not used for more than 10 minutes.

4.2 Display interface switching

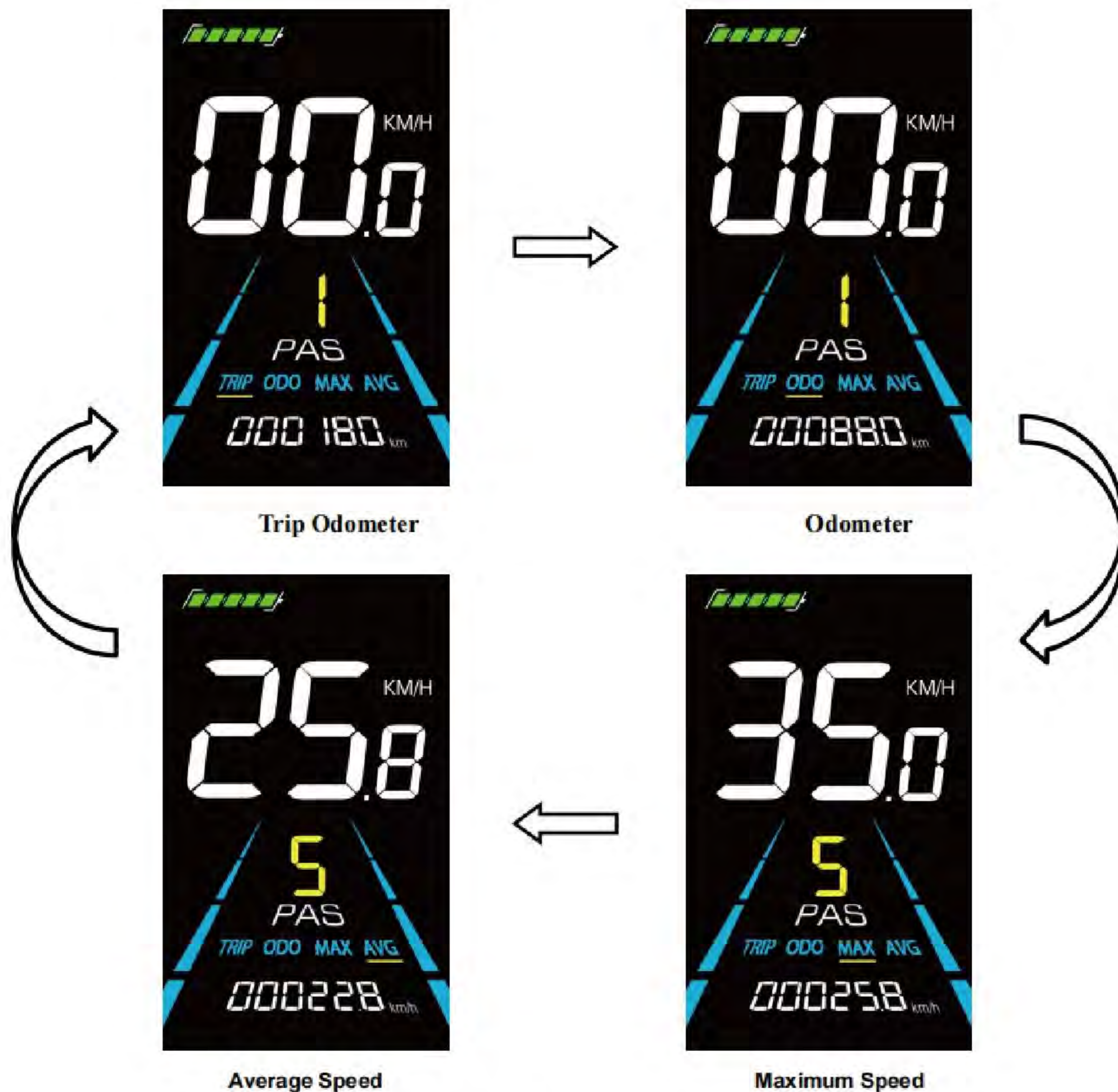
When the display is powered on, it will show the Current Speed (km/h) and Trip Odometer (km) by default. Short press  to switch between Trip Odometer(km), Odometer (km), Maximum Speed (km/h), and Average Speed (km/h).





4.3 Walk boost mode



Long Press and hold  , the electric bicycle enters the walk boost mode. The electric bicycle will walk at a fixed speed of 6 km per hour and the display shows  . Release  to stop the power output immediately and restore to the state before walk boost.

 The walk boost mode can only be used when pushing the electric bicycle, please do not use it while riding.

4.4 Turning on/off lights

Press the  to make the controller turn on the lights and the display backlight becomes dim. Press  again to make the controller turn off the lights and the backlight restore brightness.

4.5 PAS level

Press  /  to switch PAS level of electric bicycle, thus changing the motor output power.

4.6 Battery level display

The Battery level is shown as 5 bars. When the battery is full charged, all of the 5 bars lighten up. When the battery is fully depleted, the bar will begin to flash, warning the user to charge the battery as soon as possible.

4.7 Error code display





If there is a fault occurs in the electronic system of the electric bicycle, the display will automatically show an error code, see ERROR Code at the troubleshooting part.

 When the error code appears on the display, please troubleshoot the problem in time, the electric bicycle will not be able to drive normally after the problem occurs.

5.Quick operation



5.1 Restore factory settings

dEF is the restore factory default parameter settings. dEF-Y is to restore default settings, and dEF-N is not to restore.

Enter into the main setting interface and keep the speed at 0, press and hold  and  simultaneously for 2s to enter the restore factory default setting interface. Pressing  /  to toggle to dEF-Y. Then after pressing  to confirm, the display will show dEF-0 for a few seconds and then automatically start to restore the factory default settings. The display will automatically exit to setting interface after the restoration.

5.2 Trip odometer reset

The display can record trip odometer and odometer. Trip odometer is not automatically reset after turning off. The trip odometer needs to be reset manually.

Enter into the main setting interface and keep the speed at 0, press and hold  and  simultaneously for 2s to reset the trip odometer. The main interface will flash during the reset process.

Before your first ride

1. Check all nuts, bolts, and screws are tightened. If you suspect that something is loose, do not ride your bicycle. Try to fasten them carefully. If you are not sure, take your bicycle to a bicycle repair shop for service.
2. Adjust the seat to a proper height so that your legs can be comfortably stretched.
3. Check the front and rear brakes to see whether they are working correctly.
4. Fully charge the battery.
5. Pay attention to your first acceleration.

The acceleration of your Freesky eBike may be faster than anticipated, and may feel unusual at first. Before your first ride, you should use the lowest level of pedal assist (PAS 1) and become familiar with the operation of your eBike by practicing starting, stopping, cornering, and navigating obstacles in a safe environment away from other bicycles, pedestrians, and/or vehicles. You should also pay particular attention to terrain conditions as you may approach obstacles faster than expected. The Pedal Assist may be activated as soon as you step onto the pedals and the bicycle is in motion. ALWAYS be seated on the bicycle and engage at least one brake before starting to pedal. DO NOT place one foot on a pedal then throw your other leg over the bicycle or your eBike could accelerate unexpectedly.

6. When using throttle, try to push slowly to get a moderate speed and then push to the end to get the maximum speed. If you push the throttle hard at the beginning, the acceleration of your Freesky eBike may be faster than anticipated, which may cause the bike to lose control.
7. ALWAYS apply even pressure to both brake levers when slowing down or stopping. If only the front brake is applied while slowing or stopping quickly, you may be ejected over the front handlebars.

Daily Care and Maintenance

Cleaning and Storage

If you see stains on the bike body, wipe them off with a damp cloth. If the stains won't scrub off, put on some toothpaste, and brush them with a tooth brush, then wipe them off with a damp cloth.

Notes: do not clean the bike with alcohol, gasoline, kerosene or other corrosive and volatile chemical solvents to prevent dire damage. Do not wash the bike is with a high-pressure water spray. During cleaning, make sure that the bike turned off, the charging cable is unplugged, and the rubber flap is closed as water leakage may result in electric shock or other major problems. When the bike is not in use, keep it indoors where it is dry and cool. Do not put it outdoors for along time. Excessive sunlight, overheating and over cooling accelerate the battery pack's life span.

Battery Storage

Charge the battery pack before and during storage. When the battery pack will not be used for weeks or months, remove it from the eBike and store the battery pack at about 60 % charge as indicated by the Energy Bar on the display. At about 60% charge, the battery will degrade less, compared to higher charge levels. Every 2-3 months check the battery charge level and recharge to 60%, if necessary.

Note: If the battery is stored with no charge for an extended period of time, it may be damaged despite the low self-discharge and may reduce the battery capacity. For optimum service life for your battery pack, charge the battery pack to 100% a few hours before you plan to ride. If possible, store the battery pack in a dry, well-ventilated place. Protect it from moisture and water. For an optimum service life, store your Freesky eBike battery at temperatures between 50° F and 68° F. Never store it at temperatures below 14° F or above 140° F. Make sure the maximum storage temperature is not exceeded. Do not leave

the battery in your car during the summer, for example, and store it away from direct sunlight.

NOTE: Leaving the battery installed on the bicycle for long-term storage is not recommended.

Battery Disposal

When your battery is no longer usable, dispose of your battery according to state and federal regulations. State regulations regarding battery disposal vary so it is important you find out and follow the rules in your state. Lithium Ion batteries cannot be put in with standard garbage bins.

Recommended Service Intervals

Regular inspection and maintenance are key to ensure bikes from Freesky function as intended, and to reduce wear and tear on their systems. Recommended service intervals are meant to be used as guidelines. Real world wear and tear, and the need for service, will vary with condition of use. We generally recommend inspections, service, and necessary replacements be performed at the time or mileage interval that comes first in the following table.

Interval	Inspect	Service	Replace
Weekly, 100-200 miles (160-321 km)	<ul style="list-style-type: none"> - Check drivetrain for proper alignment and function (including the chain, freewheel, chainring, and derailleur). - Check wheel trueness and for quiet wheel operation (without spoke noise). - Check condition of frame for any damage. 	<ul style="list-style-type: none"> - Clean frame by wiping frame down with damp cloth. - Use barrel adjuster(s) to tension derailleur/brake cables if needed. 	<ul style="list-style-type: none"> - Replace any components confirmed by Freesky, Product Support or a certified, reputable bike mechanic.
Monthly, 250-750 miles (402-1207 km)	<ul style="list-style-type: none"> - Check bike is shifting properly, proper derailleur cable tension. - Check chain stretch. - Check spoke tension. - Check accessory mounting (rack mounting bolts, and alignment). 	<ul style="list-style-type: none"> - Clean and lubricate drivetrain. - Check crankset and pedal torque. - Clean brake and shift cables. - True and tension wheels if any loose spokes are discovered. - Balance the battery. 	<ul style="list-style-type: none"> - Replace brake and shift cables if necessary. - Replace brake pads if necessary.
Every 6 Months, 750-1250mides (1207-2011 km)	<ul style="list-style-type: none"> - Inspect drivetrain (chain, chainring, freewheel, and derailleur). - Inspect all cables and housings. 	<ul style="list-style-type: none"> - Standard tune-up by certified, reputable bike mechanic is recommended. - Grease bottom bracket. 	<ul style="list-style-type: none"> - Replace brake pads. - Replace tires if necessary. - Replace cables and housings if necessary.

Pre-Ride Safety Checklist

Notice: Before every ride, and after every 25-45 miles(40-72 km), we advise you following the pre-ride safety checklist.

Safety Check	
1.Brakes	<p>Ensure front and rear brakes work properly.</p> <p>Check brake pads for wear and ensure they are not overworn.</p> <p>Ensure brake pads are correctly positioned in relation to the rims.</p> <p>Ensure brake levers are lubricated and tightly secured to the handlebar.</p> <p>Test that the brake levers are firm and that the brake is functioning properly.</p>
2.Wheels and Tires	<p>Ensure tires are inflated within the recommended limits posted on the tire sidewalls and hold air.</p> <p>Ensure tires have good tread, have no bulges or excessive wear, and are free from any other damage.</p> <p>Ensure rims run true and have no obvious wobbles, dents, or kinks.</p> <p>Ensure all wheel spokes are tight and not broken.</p> <p>Check axle nuts and front wheel quick release to ensure they are tight. Ensure the locking lever on the quick release skewer is correctly tensioned, fully closed, and secured.</p>
3.Steering	<p>Ensure the handlebar and stem are correctly adjusted, tightened, and allow proper steering.</p> <p>Perform a handlebar twist test to ensure the stem clamp bolt security.</p> <p>Ensure the handlebar is set correctly in relation to the fork and the direction of travel</p>
4.Chain	<p>Ensure the chain is clean, oiled, and runs smoothly.</p> <p>Extra care is required in wet, salty/otherwise corrosive, or dusty conditions.</p>
5.Bearings	<p>Ensure all bearings are lubricated, run freely, and display no excess movement, grinding, or rattling.</p> <p>Check headset, wheel bearings, pedal bearings, and bottom bracket bearings.</p>
6.Cranks and Pedals	<p>Ensure pedals are securely tightened to the cranks.</p> <p>Ensure the cranks are securely tightened and are not bent.</p>
7.Derailleur and Mechanical Cables	<p>Check that the derailleur is adjusted and functioning properly.</p> <p>Ensure shifter and brake levers are attached to the handlebar securely.</p> <p>Ensure all shifter and brake cables are properly lubricated.</p>

Safety Check	
8.Frame, Fork, and Seat	<p>Check that the frame and fork are not bent or broken. If either frame or fork are bent or broken, they should be replaced. Check that the seat is adjusted properly, and seatpost quick release lever is securely tightened.</p>
9.Motor Drive Assembly and Throttle	<p>Ensure hub motor is spinning smoothly and motor bearings are in good working order. Ensure all power cables running to hub motor are secured and undamaged. Make sure the hub motor axle bolts are secured and the torque arm, torque arm bolt, and torque washers are in place.</p>
10.Battery	<p>Ensure battery is charged before use. Ensure there is no damage to battery. Lock battery to frame and ensure that it is secured. Charge and store bike and battery in a dry location, between 50 °F – 77 °F (10 °C – 25 °C). Let bike dry completely before using again.</p>
11.Electrical Cables	<p>Look over connectors to make sure they are fully seated and free from debris or moisture. Check cables and cable housing for obvious signs of damage. Ensure front light is functioning, adjusted properly, and unobstructed.</p>
12.Accessories	<p>Ensure all reflectors are properly fitted and not obscured. Ensure all other fittings on bike are properly secured and functioning. Inspect helmet and other safety gear for signs of damage. Ensure rider is wearing a helmet and other required riding safety gear. Ensure mounting hardware is properly secured if fitted with a front rack, rear rack, basket, etc. Ensure the taillight and taillight power wire are properly secured if fitted with rear rack. Ensure the fender mounting hardware is properly secured if fitted with fenders. Ensure there are no cracks or holes in fenders. If installed, ensure the optional rear wheel lock is secured in the unlocked position and the key is removed before every ride.</p>



Your cables, spokes, and chain will stretch after an initial break-in period of 50-100 mi (80-160 km), and bolted connections can loosen. Always have a certified, reputable bike mechanic perform a tune-up on your bike after your initial break-in period of 50-100 mi (80-160 km) (depending on riding conditions such as total weight, riding characteristics, and terrain). Regular inspections and tune-ups are particularly important for ensuring that your bike remains safe and fun to ride.

Tire Inflation and Replacement

The Wild Cat employs 26"×4"rubber tires with inner tubes. The tires are designed for durability and safety for regular cycling activities and need to be checked before each use for proper inflation and condition. Proper inflation, care, and timely replacement will help ensure that your bike's operational characteristics will be maintained, and unsafe conditions avoided.

Freesky recommends 24-30 PSI for the stock tires. Always stay within the manufacturer's recommended air pressure range as listed on the tire sidewall.



It is critically important that proper air pressure is always maintained in pneumatic tires. Do not underinflate or overinflate your tires. Low pressure may result in loss of control, and overinflated tires may burst. Failure to always maintain the air pressure rating indicated on pneumatic tires may result in tire and/or wheel failure.



Inflate your tires from a regulated air source with an available pressure gauge. Inflating your tires from an unregulated air source could overinflate them, resulting in a burst tire.

Even tires equipped with built-in, flat-preventative tire liners, like those that come with bikes from Freesky, can and do get flats from punctures, pinches, impact, and other causes. When tire wear becomes evident or a flat tire is discovered, tires and/or tubes must be replaced before operating the bike or injury to operators and/or damage to your bike from Freesky could occur.



When changing a tire or tube, ensure that all air pressure has been removed from the inner tube prior to removing the tire from the rim. Failure to remove all air pressure from the inner tube could result in serious injury.



Using aftermarket tires or inner tubes, not provided by Freesky may void your warranty, create an unsafe riding condition, or damage to your bike. If required by law, ensure replacement aftermarket tires have sufficient reflective sidewall striping.

For more information on tire or tube replacement procedures, or questions about tire inflation, contact Freesky after-sale service at support@freeskycycle.com.

Troubleshooting

	Symptoms	Possible Causes	Most Common Solutions
1	The bike does not work	<ol style="list-style-type: none"> 1. Insufficient battery power 2. Faulty connections 3. Battery not fully seated in tray 4. Improper turn on sequence 5. Brakes are applied 6. Blown discharge fuse 	<ol style="list-style-type: none"> 1. Charge the battery 2. Clean and repair connectors 3. Install battery correctly 4. Turn on bike with proper sequence 5. Disengage brakes 6. Replace discharge fuse
2	Irregular acceleration and/or reduced top speed	<ol style="list-style-type: none"> 1. Insufficient battery power 2. Loose or damaged throttle 3. Misaligned or damaged magnet ring 	<ol style="list-style-type: none"> 1. Charge or replace battery 2. Replace throttle 3. Align or replace magnet ring
3	The motor does not respond when the bike is powered on	<ol style="list-style-type: none"> 1. Loose wiring 2. Loose or damaged throttle 3. Loose or damaged motor plug wire 4. Damaged motor 	<ol style="list-style-type: none"> 1. Repair and or reconnect 2. Tighten or replace 3. Secure or replace 4. Repair or replace
4	Reduced range	<ol style="list-style-type: none"> 1. Low tire pressure 2. Low or faulty battery 3. Driving with too many hills, headwind, braking, and/or excessive load 4. Battery discharged for long period of time without regular charges, aged, damaged, or unbalanced 5. Brakes rubbing 	<ol style="list-style-type: none"> 1. Adjust tire pressure 2. Check connections or charge battery 3. Assist with pedals or adjust route 4. Balance the battery; contact Tech Support if range decline persists 5. Adjust the brakes
5	The battery will not charge	<ol style="list-style-type: none"> 1. Charger not well connected 2. Charger damaged 3. Battery damaged 4. Wiring damaged 5. Blown charge fuse 	<ol style="list-style-type: none"> 1. Adjust the connections 2. Replace 3. Replace 4. Repair or replace 5. Replace charge fuse
6	Wheel or motor makes strange noises	<ol style="list-style-type: none"> 1. Loose or damaged wheel spokes or rim 2. Loose or damaged motor wiring 	<ol style="list-style-type: none"> 1. Tighten, repair, or replace 2. Reconnect or replace motor.

Error Code:

The components of your Freesky eBike are continuously monitored automatically. If a fault is detected, the corresponding error code will appear on the display. The motor then might be not functional.

Error Code	Description	Method
001	Controller Fault	Check the controller cable connector inside the controller box. Contact technical support for more.
002	Communication Fault	Check the display cable connector. Contact technical support for more.
003	Hall Fault	Check the connector of the motor cable. Contact technical support for more.
004	Throttle Fault	Check the connector of throttle cable. Contact technical support for more.
005	Brake Fault	Check the connector of brake cable. Contact technical support for more.
006	Motor Phase Fault	Check the connector of the motor cable. Contact technical support for more.

Specifications

ITEM	SPECIFICATIONS
Model	Wild Cat
Product Dimensions	195x72x102(cm)
Package Dimensions	158x35x82(cm)
Max Load	300 lbs(135kg)
Package Weight	101.6 lbs
E Bike Weight	92 lbs
Max Speed	20MPH on throttle, 28MPH on Pedal Assist
Battery/Charger	Input 100-240V 50/60HZ AC Plug; Output 54.6V 3A
Range	45-90miles
Charging Time	4-8 hours
Tire Pressure	24-30 PSI
Recommended Rider Heights	5'4"-6'8"
Charging Port	Output Voltage 54.6V 3A
Frame Material	Artificial Mechanics 6061 Aluminum Alloy Frame
IP Level	Ip65

FAQS

Q: What if the e-bike arrived missing accessory or broken part?

A: Please take a photo and send to Freesky Support Team by sending email: support@freeskycycle.com and Freesky Support Team will reply you soon and send correct accessory or part replacement.

Q: Will my bike arrive assembled?

A: Your bike will arrive mostly assembled. We' ll also provide the tools and a comprehensive assembly video for the rest part.

Q: What can I do if something goes wrong with my e-bike during the warranty?

A: We believe that communication is the best way to solve the problem. Please contact us in time. To help you solve the problem as quickly as possible, please describe the problem in detail and provide photos/videos with your order ID.

Warranty

The warranty is non-transferable and only applies to the original owner. This warranty gives you specific rights and purchasers may also have other rights, which may vary from state to state. Damage caused by failing to follow instructions in the manual, acts of God, accident, misuse, neglect, abuse, commercial use, alterations, modification, improper assembly, installation of parts or accessories not originally intended or compatible with the Freesky eBike as sold, operator error, water damage, extreme riding, stunt riding, or improper follow-up maintenance is not covered under this warranty.

Warranty parts will only be shipped within the continental United States.

Parts covered by the warranty: frame, forks, stem, handlebars, headset, seat post, saddle, brakes (excluding brake pads), lights, bottom bracket, crank set, pedals, rims, wheel hub, freewheel, cassette, derailleur, shifter, motor, throttle, controller, wiring harness, display (excluding damage due to water), kickstand, reflectors, and hardware. The battery warranty does not include damage from power surges, use of 3rd party charger, improper maintenance or other such misuse, normal wear, or water damage (including rust).

Accessories sold on freeskycycle.com are not covered under warranty. Stolen bikes are not covered under warranty.

Necessary precautions must be taken to ensure the bike and battery are not exposed to severe weather conditions. Exposure to very wet, hot, or cold conditions may void the warranty.

Freesky eBikes will replace any parts deemed to have been damaged during shipping. Shipping damage must be reported to Freesky eBikes within 7 days of shipment arrival.

This applies to all products, including bikes and accessories. You will NOT be refunded as compensation for your time or efforts replacing damaged parts.

Replacement parts will not be sent until photographic evidence has been provided to

Freesky eBikes. Freesky eBikes may request additional documentation (such as video) to assist with accurately diagnosing the problem and processing the warranty claim.

Most warranty parts will be fulfilled in 5 business days after the request is put into our system by a customer service representative. Warranty parts will be sent from our American warehouse if stock is available, or we will ship from China factory, where the shipping time takes around 2 weeks. Warranty parts will not be expedited.

Items including the chain, tires, wheels, rims, tubes, battery handle, brake rotors, brake pads, cables and housings, grips, and spokes are considered wear items. These items wear down with normal use and are not covered under warranty. You are responsible for replacing and maintaining these wear items.

Any unauthorized alterations or repairs are not covered and may void this warranty.

For warranty services, please contact Freesky ebike's online support by email at support@freeskycycle.com. Bikes or parts returned without proper documentation may result in delayed service or denied warranty coverage. Warranty return shipping costs along with duties and taxes are the responsibility of the claimant. All unauthorized returns will be refused.

Note that your insurance policies may not provide coverage for accidents involving Freesky eBikes. To determine if coverage is provided, you should contact your insurance company or agent.

Damage as a result of an accident is not covered under this warranty, and Freesky eBikes is not responsible for repair or replacement of damaged bikes or parts.

Freesky eBikes reserves the right to change its warranty at any time and without notice. Any action, lawsuit or other proceeding, under this warranty or otherwise related to the bike must be commenced within ninety (90) days after expiration of the one-year warranty period.

Bike Performance Disclaimer

The bikes listed range and top speed are estimates (not guarantees) of expected performance. Performance will vary with rider weight, cargo weight, rider/cargo shape (both contribute to drag), terrain, tire pressure, brake adjustment, throttle & PAS usage, pedal power, battery charge level, ambient temperature, and wind conditions.

Under certain conditions it is possible to get ranges and top speeds that are different from the listed estimates.

To get the maximum range out of each battery charge, there are some simple things you can do:

- Ride at a lower PAS level
- Use lower PAS levels and pedal when climbing hills
- Pedal when starting from a standstill

Liability Disclaimer

Riding any kind of bicycle comes with inherent risks and dangers that cannot be predicted or avoided. These dangers could result in a serious accident, injury, or death of the rider. It is the sole responsibility of the rider to become properly educated and prepared to ride safely. Once in possession of the bike, Freesky eBikes strongly encourages and recommends that all customers have a certified and reputable bicycle mechanic complete a full inspection of each component on the bicycle to ensure it is safe for operation.

Freesky eBikes makes no claims or guarantees that the brakes, battery, frame, motor, motor controller, display, electrical cables, electrical cable housings, fasteners, grips, fork, stem, shifters, headset, seat post, seat post clamp, handlebar stem clamp, saddle, wheel hubs, handlebars, spokes, rims, tires, tubes, derailleur, freewheel, cassette, throttle, kickstand, lights, reflectors, hardware, bottom bracket, or any other part or accessory, will be properly secured and adjusted upon arrival. Before every ride, fully inspect your bicycle to ensure everything is secured and adjusted properly. Under no circumstances is Freesky eBikes responsible for any damage resulting from damaged, defective, or improperly secured parts. This includes, but is not limited to, damage to personal property, personal injury, or death.

Refund Policy

PARTS DAMAGE

Ebikes from Freesky may experience some damages because of long-time transportation, such as the screw bent or reflector broken. Send us pictures immediately after you get the item. After approval, we will send you replacement parts or partial refund upon agreement.

EBIKE RETURNS

Ebikes from Freesky are under 15-day return policy, which means you have 15 days after receiving your item to request a return. To return an ebike that is not defective or damaged, please contact the customer service team within 15 days. We do not provide product returns service after 15 days, as same as refund.

Please make sure the following if you need to return the bike:

- 1. The mileage on the LCD screen of the ebike must be less than 10 miles.**
- 2. There should be no wear, dirt, scratches, fragrances, or any other signs of use.**
- 3. All items (charger, keys, hardware, etc.) received by the customer must be included in the original packaging (all cardboard and foam) and in the same condition.**

You will be responsible for paying the shipping costs for returning your item under this condition. Original and return shipping costs are nonrefundable, and we do charge a restocking fee up to 25% of order value for the return. Return shipping fees may vary depending upon the chosen freight carrier. Customers are responsible for arranging return shipping and paying any fees.

We recommend using a trackable shipping service and purchasing shipping insurance.

Before a return is sent, the customer must have written approval of said return from Freesky.

If a customer sends a return without the written consent of Freesky, a refund will not be issued and the customer will have to pay for shipping to get the item returned, or sacrifice the item.

Once we received the item, we will conduct a detailed inspection on the package, then we will either replace the item or give you a partial refund according to the actual condition of the

item we received. This will be issued in 2-5 business days.

For ebike that has been delivered for more than 15 days or used for more than 10 miles, if there is any problem, we do not accept returns anymore, only repairs and replacements are allowed.

LATE OR MISSING REFUNDS

If you haven't received a refund after 5 business days of approval, please check your bank account again and contact your credit card company/bank as it may take some time before your refund is officially posted. There is often some processing time before a refund is posted. If you've done all of this and you still have not received your refund, please contact us at service@freeskycycle.com.



FREESKY
go anywhere