

FRONT BUMPER

User Manual

2007-2018 JEEP WRANGLER JK
2018-2023 JEEP WRANGLER JL
2019-2023 JEEP GLADIATOR JT



Model:	NJL01A109
Material:	Q235A
Product Dimensions:	66.8 x 10.37 x 16.34 inch
Package Dimensions:	47.2 x 15.7 x 11 inch
Product Weight:	72.75 lbs

※ Thank you for purchasing the FRONT BUMPER. Please read this manual carefully and keep it properly if you need to refer to it afterward. If you need any support or assistance, please contact us with your product model number and order number, and our support team will help you solve problems.





⚠ WARNING

※ This product is designed primarily to enhance the appearance of the vehicle. Do not rely in any way on the components of this product to protect against injury or death in the event of an accident. To reduce the risk of serious injury or property damage, please read all safety messages and understand all instructions and procedure notices before attempting to install or use this product.



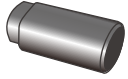

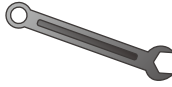
⚠ CAUTION





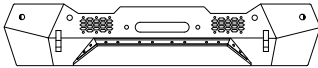
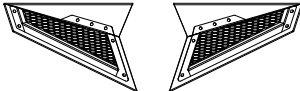
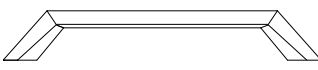
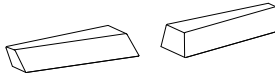
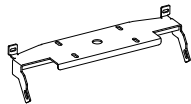
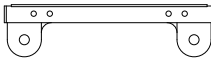

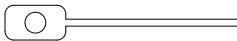
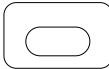

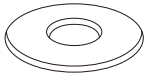
※ Properly torque and recheck fasteners and security of step tread after 250 miles and inspect frequently. Do not use if damaged.

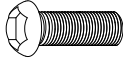
REQUIRED TOOLS

Socket 	Ratchet 	Wrench 	Allen Wrench 	Safety Glasses 
---	--	---	--	---

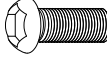
Parts Information

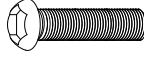
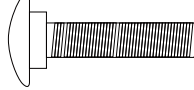
NO.	Parts Name	Size	Line Graph	Qty	Color
/	Mid Bumper	/		1	Black
/	Left & Right Bumper	/		2	Black
/	Top Bumper	/		1	Black
/	Left & Right Bumper Cover	/		1	Black
/	Winch Bracket	/		1	Black
/	License Bracket	/		1	Black
/	Tow Hook Bracket	/		1	Black
/	Bolt Plate	/		2	Black
/	Plate	54x33		2	Black
/	Shackles	/		2	Blue Zinc Plating
W39	Flat Washer	Φ12x44x3		3	Blue Zinc Plating

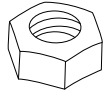
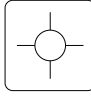
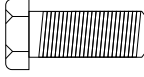
NO.	Parts Name	Size	Line Graph	Qty	Color
B19	Half Head Allen Bolts	M8x25		13	Dacro Black
W19	Flat Washer	Φ8x24x2		25	Dacro Black
W16	Spring Washer	Φ8		13	Dacro Black
N22	Hex Nuts	M8		13	Dacro Black
B12	Half Head Allen Bolts	M8x16		5	Dacro Black
N14	Hex Flange Nuts	M8		5	Dacro Black
N09	Hex Flange Nuts	M6		5	Dacro Black
B46	Half Head Allen Bolts	M6x40		5	Dacro Black
B43	Square Neck Bolt	M10x35		9	Blue Zinc Plating
W33	Flat Washer	Φ10x25x2		9	Blue Zinc Plating
W32	Spring Washer	Φ10		9	Blue Zinc Plating
N26	Hex Nuts	M10		11	Blue Zinc Plating
W21	Plastic Plate	M10		9	PVC
B53	Hex Bolts	M10x35		3	Zinc White

※ Note: spare parts such as W39、B19、W19、W16、N22、B12、N14、N09、B46、B43、W33、W32、N26、W21 and B53 are provided with 1PCS each (included in the number of parts details).

Installation Instructions

Step 1: Open the carton and take out the parts. Check whether the number of components is complete.

Step 2: Splicing the Bumper.

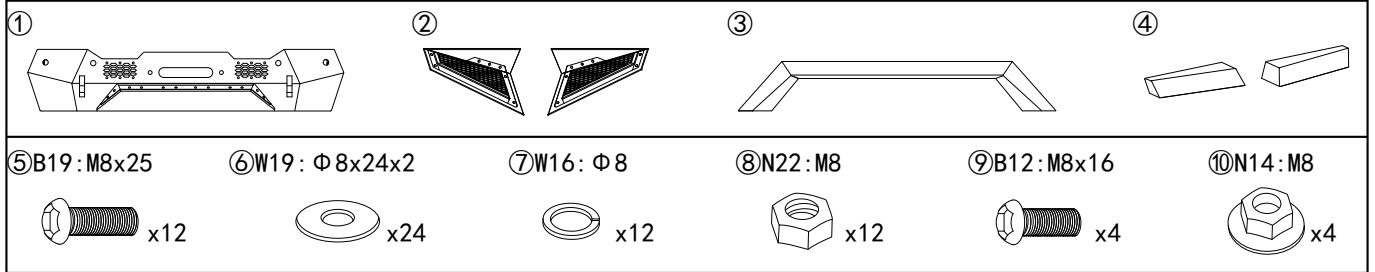

Align the holes

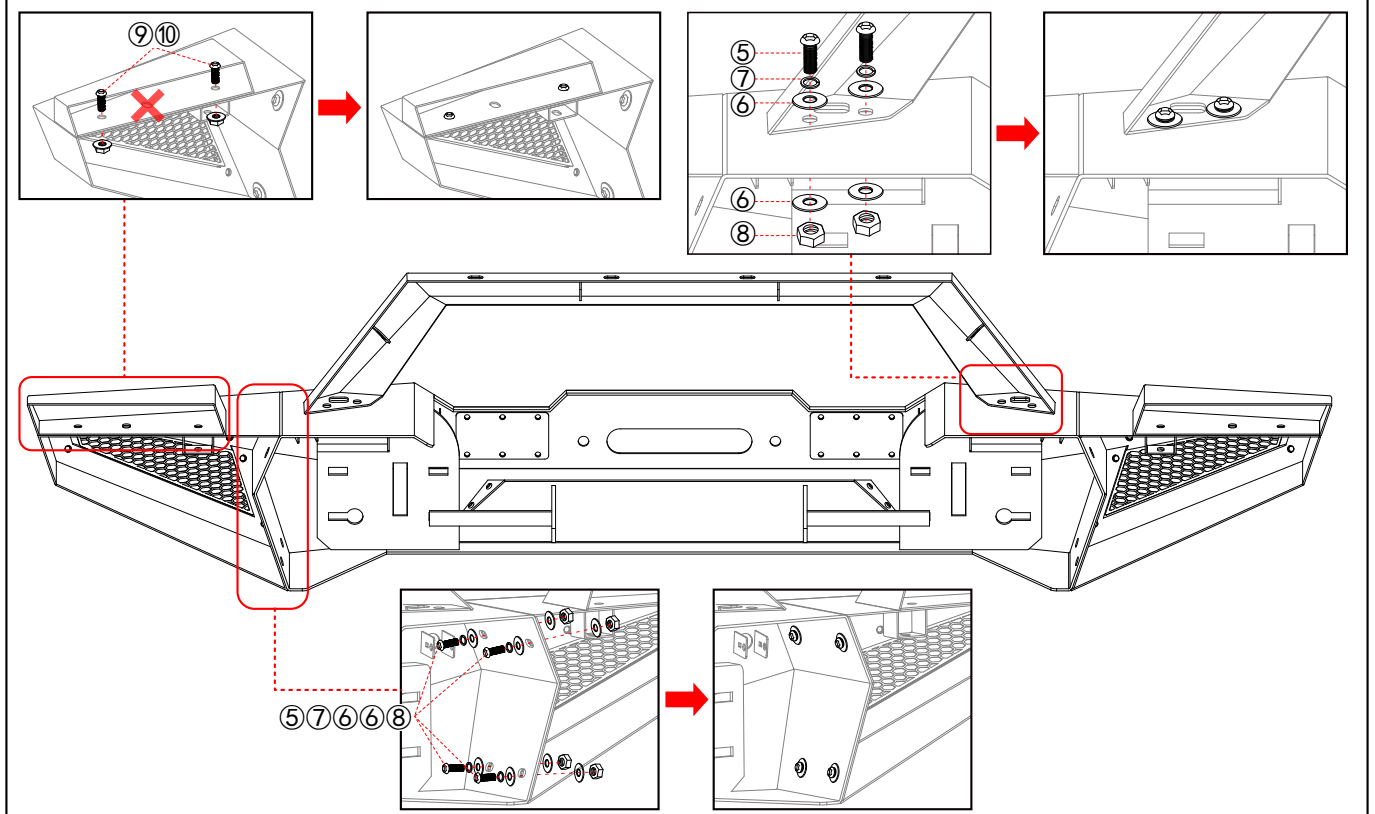
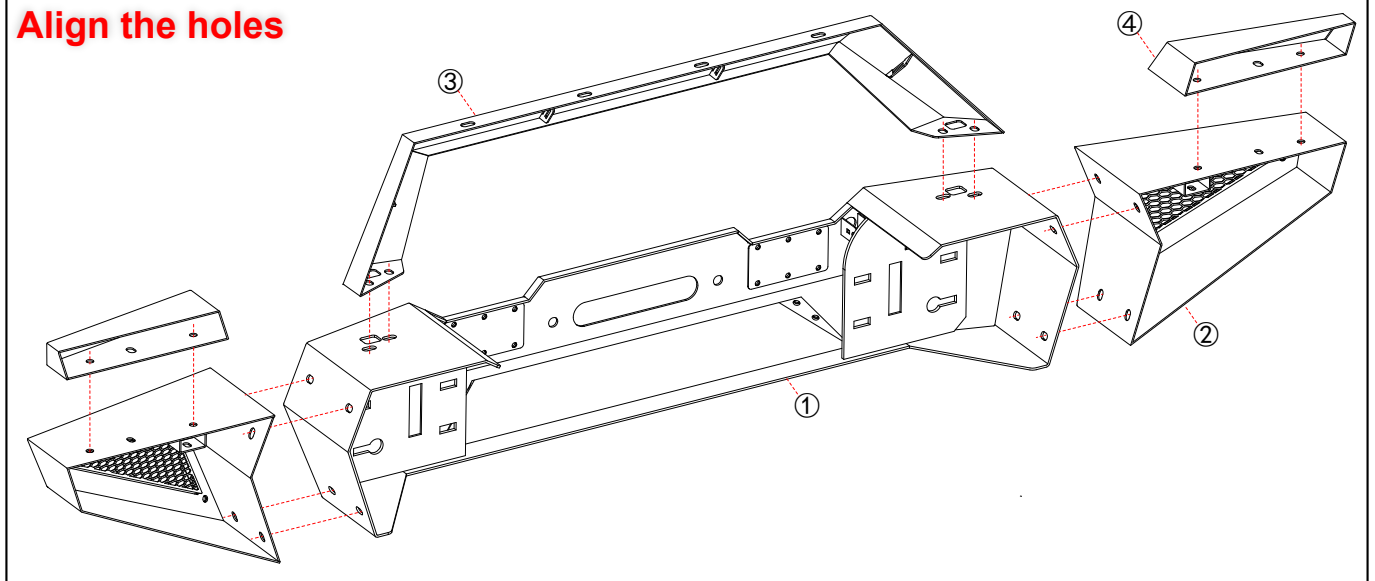

The Bumper is assembled.

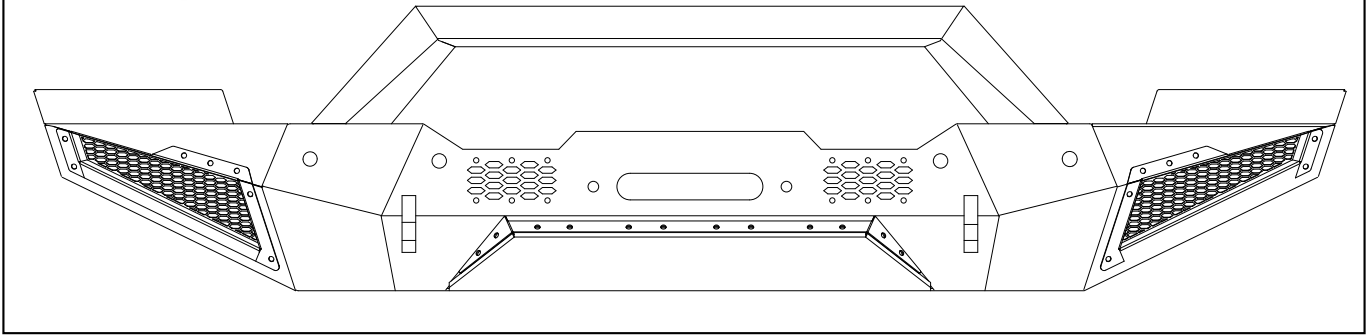

Step 3: Install the Winch Basket.

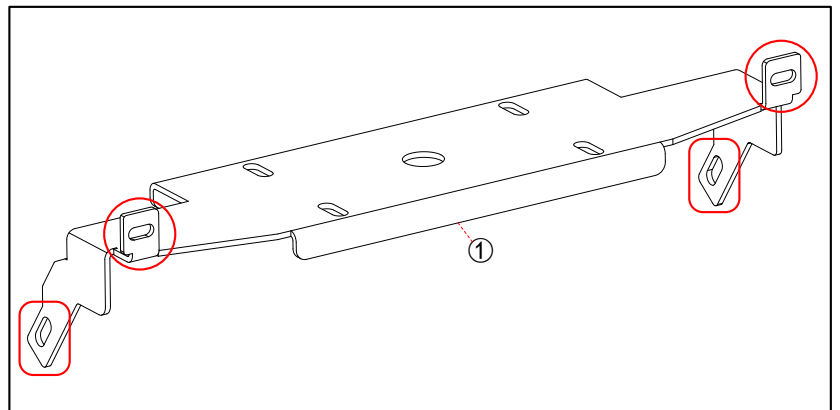
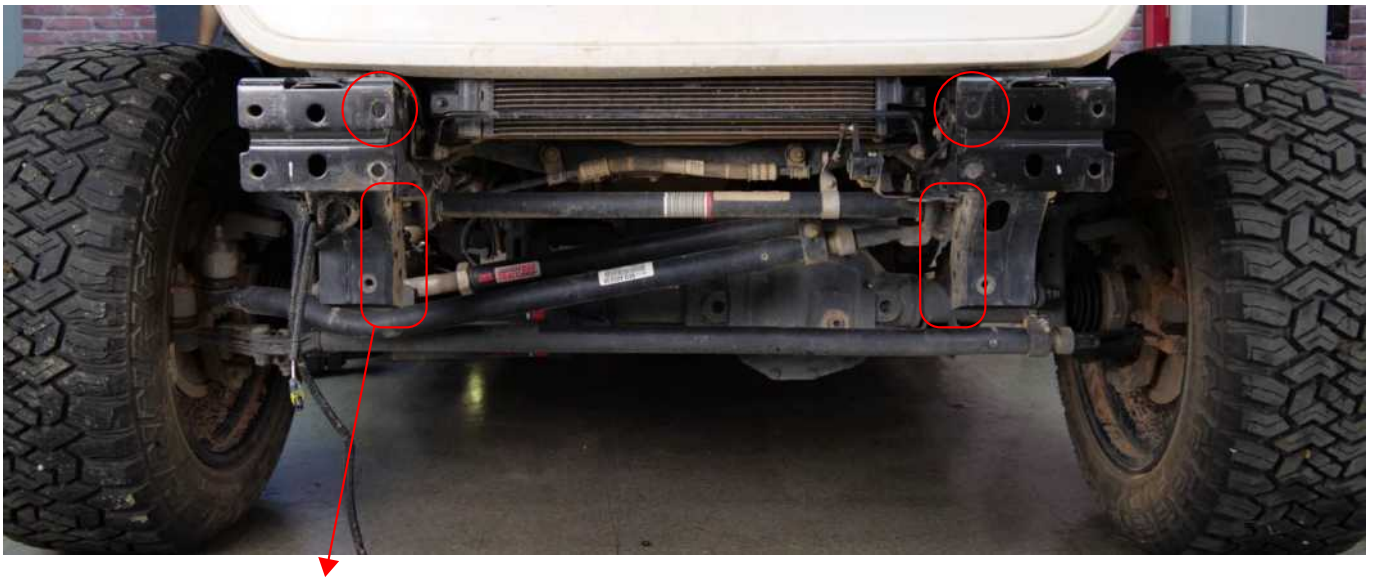
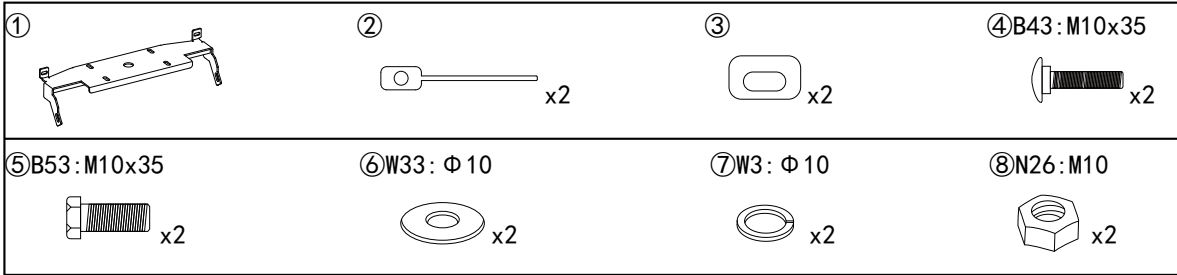

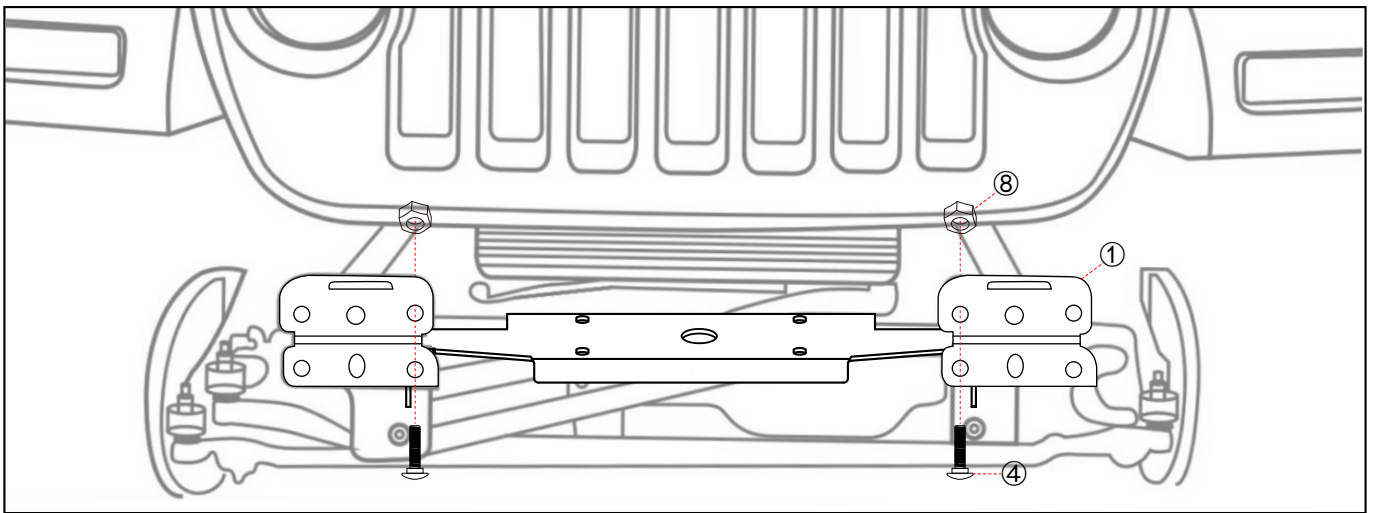
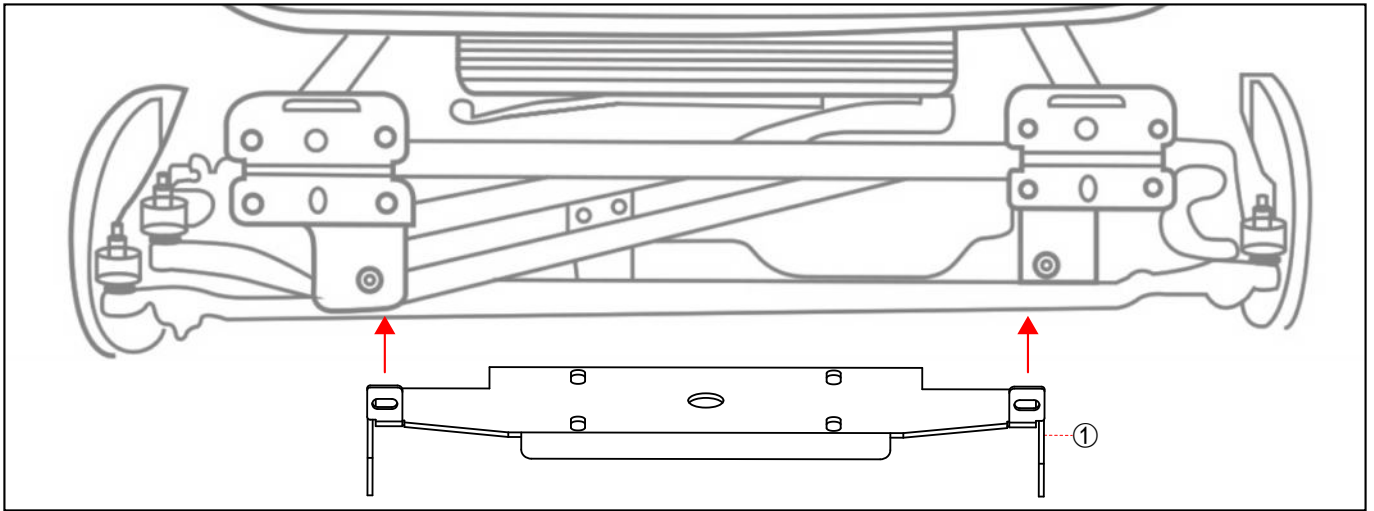

Note: Please mounting the corresponding bolts at the first. Do not tighten the bolt in this step. JK model do not need to use the ③Plate.

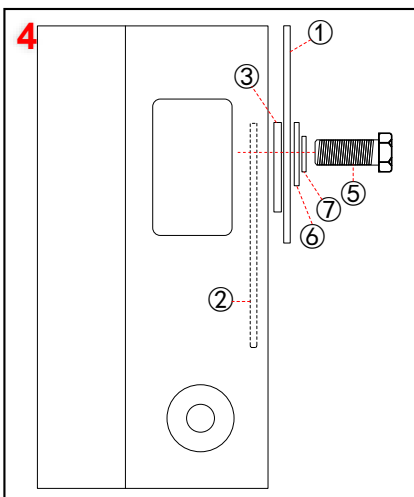
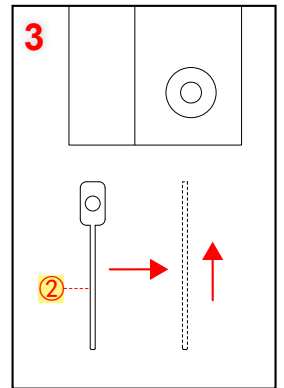
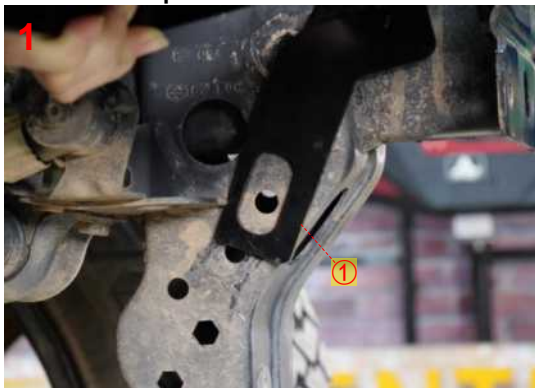



Note: The Bolt is only used to fix the Winch Bracket, and it is convenient to install the two mounting holes under the winch bracket. Please Keep it and use it in the next step.



Step 4: Install the Bumper.

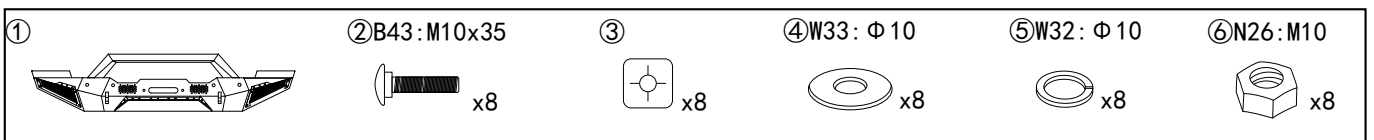

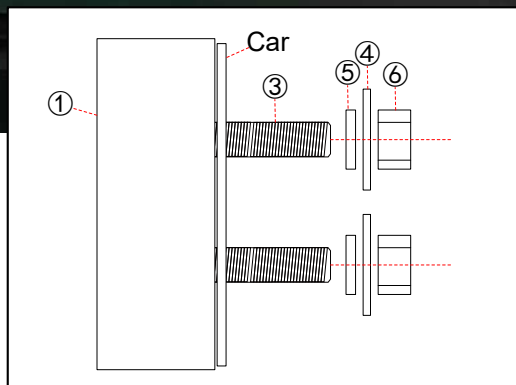
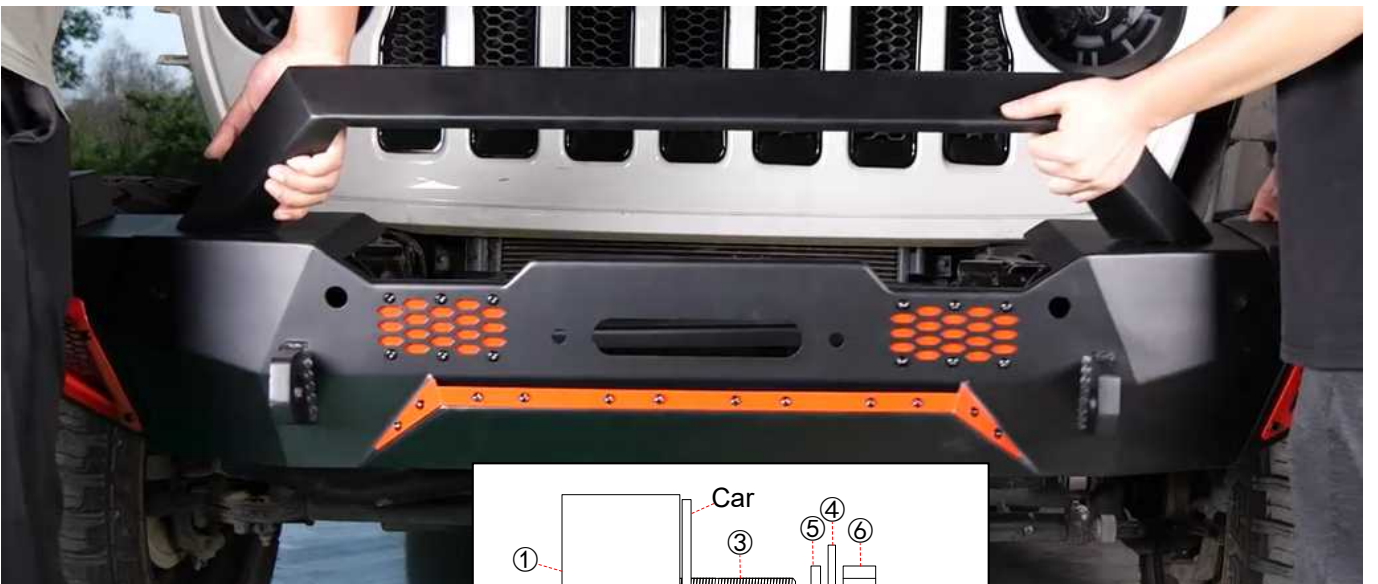
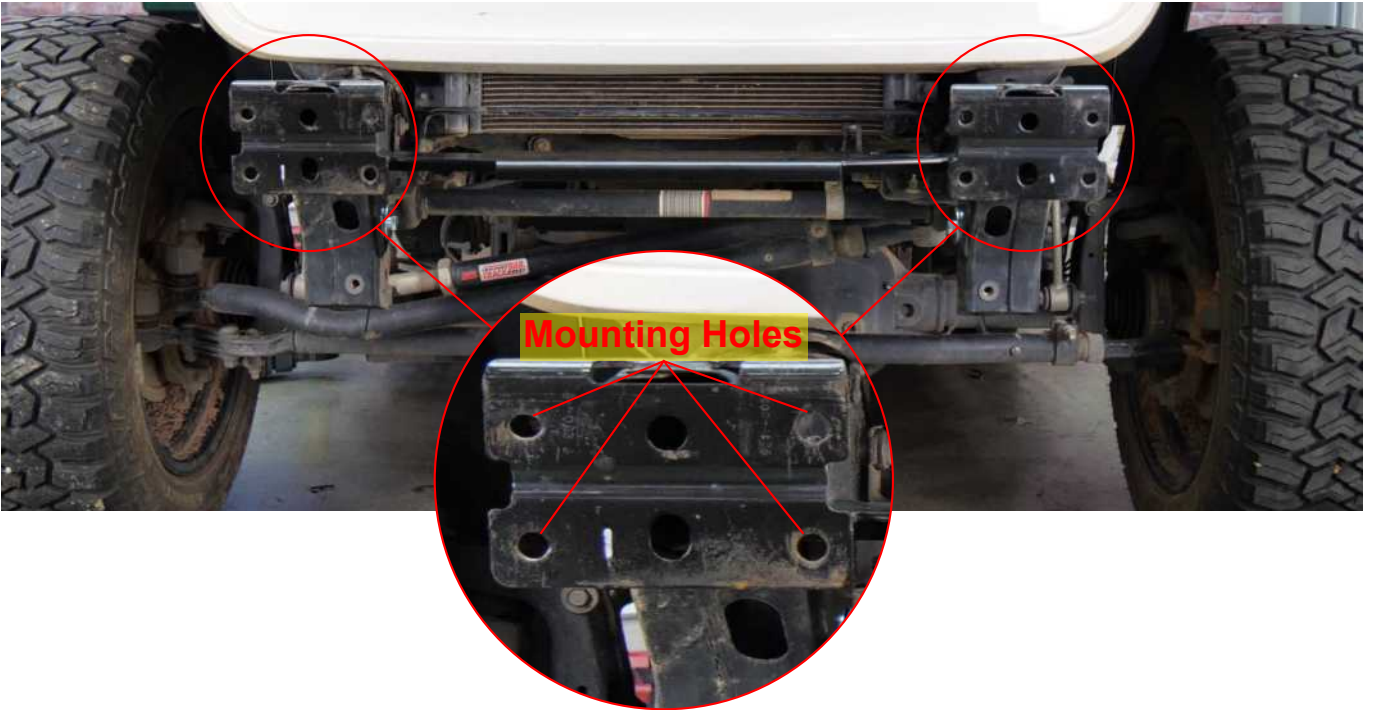

Bumper installed successfully



Step 5: Install the License Bracket.

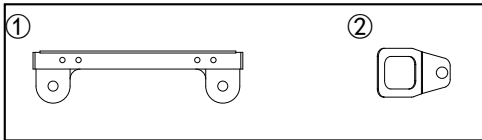

x12

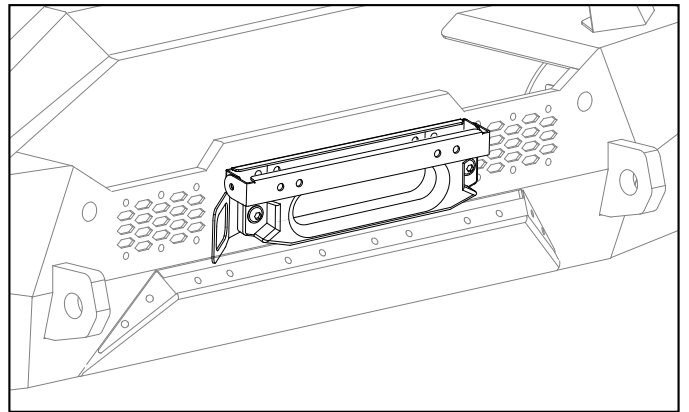
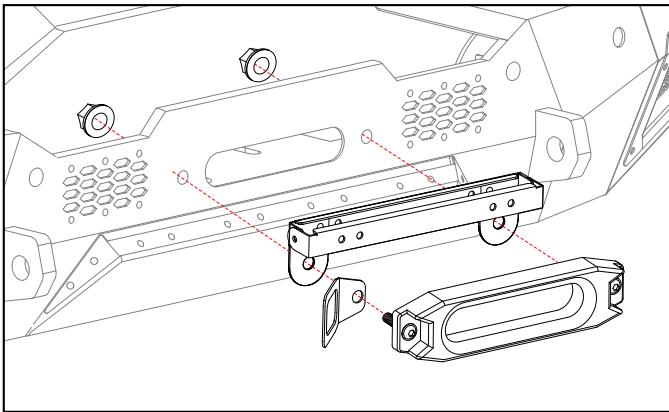

Step 6: Install the Shackles.

