

**W90HBW8/W10HBW8
W12HBW8/W14HBW8**

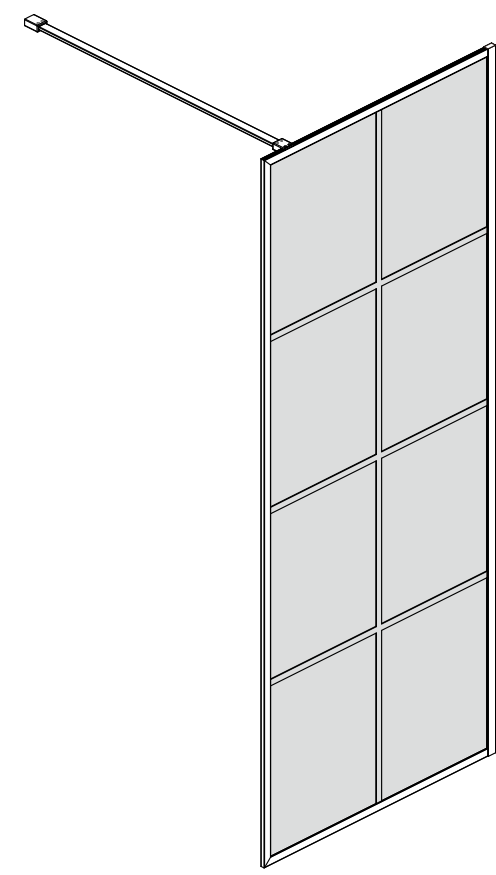



EN IMPORTANT - Please read and follow all warnings and instructions before using this product. Injury can result from improper use. Save this documents.

DE WICHTIG - Bitte lesen und befolgen Sie alle Warnungen und Anweisungen, bevor Sie dieses Produkt verwenden. Verletzungen können durch unsachgemäße Verwendung entstehen. Speichern Sie diese Dokumente.

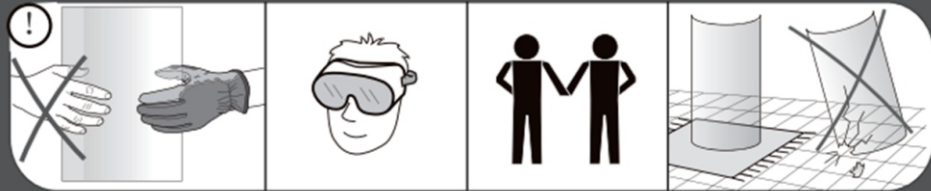
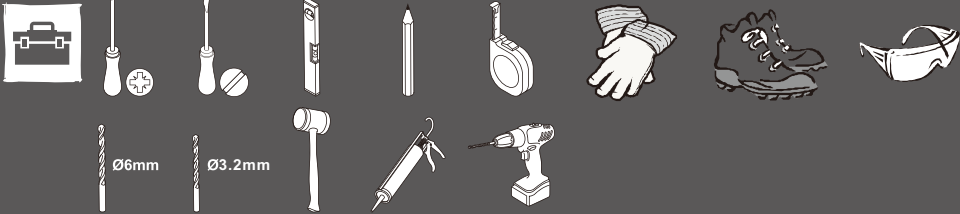

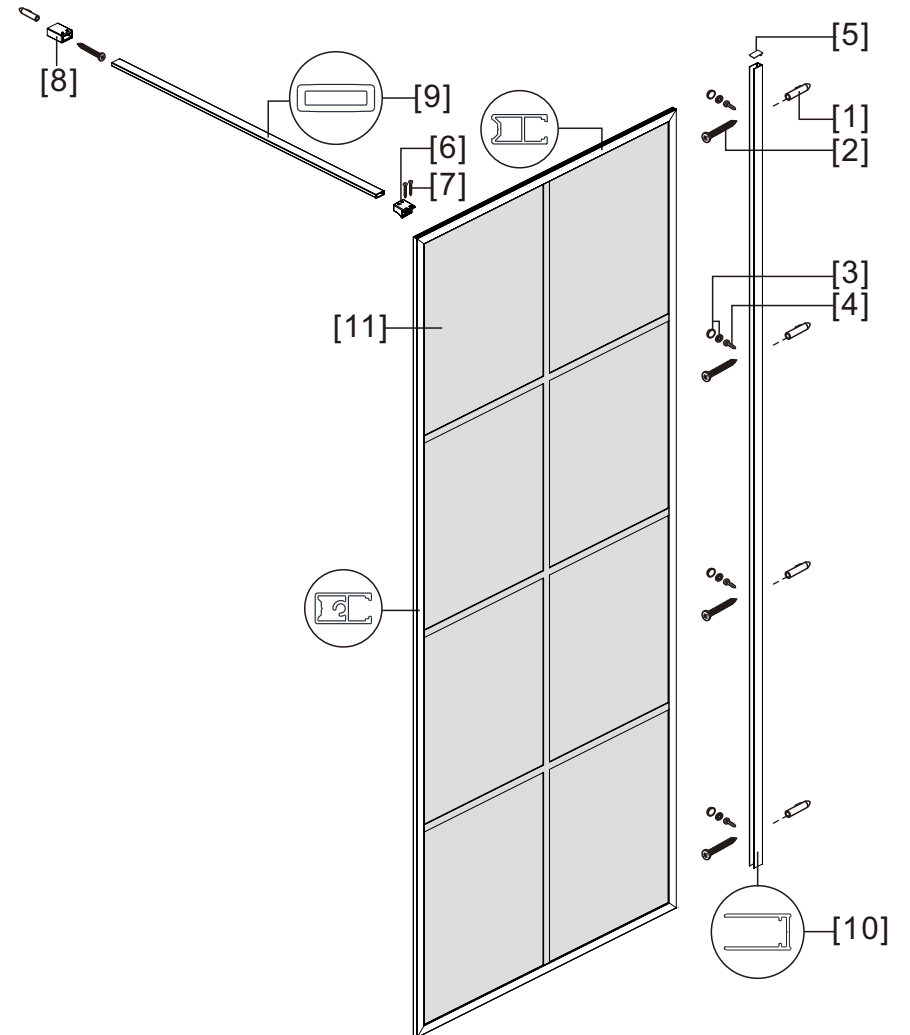

[1] x5	[2] x5 (ST4x30)	[3] x3	[4] x3 (ST4x8)	[5] x1	[6] x1
[7] x2 (ST4x12)	[8] x1	[9] x1	[10] x1		
[11] x1					





01





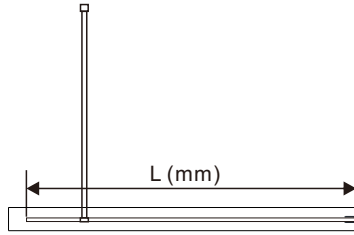

- [1]  x4
- [2]  x4 (ST4x30)
- [10]  x1

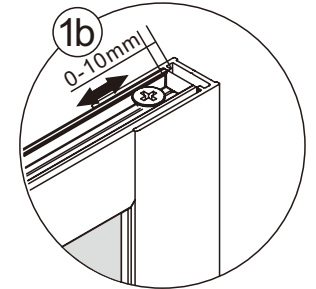
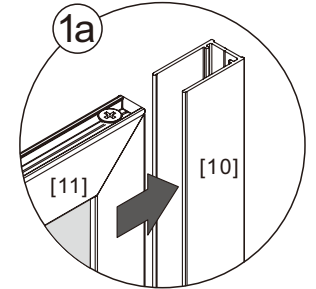
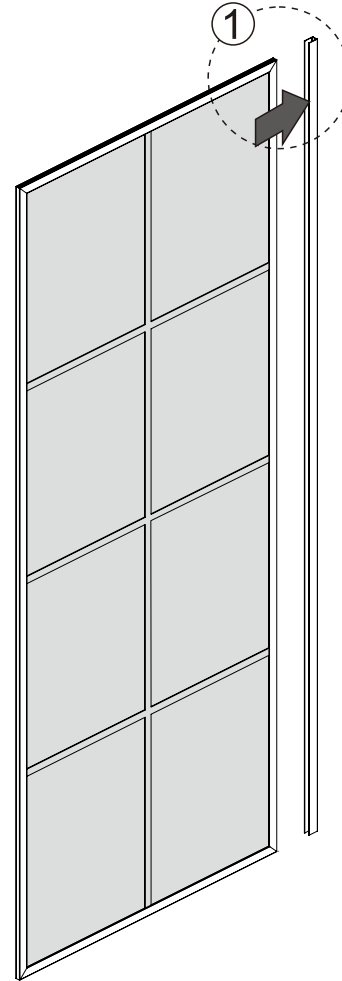
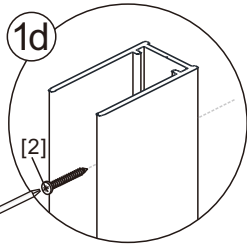
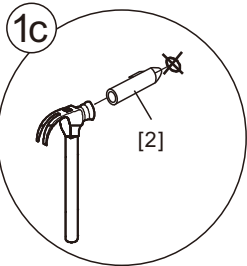
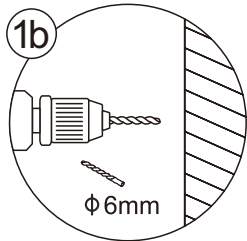
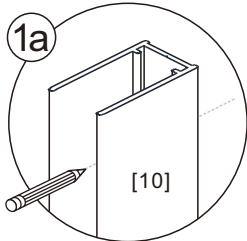
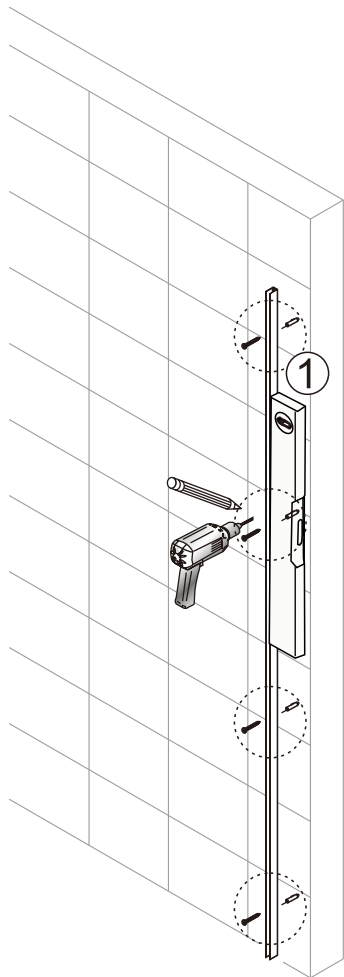
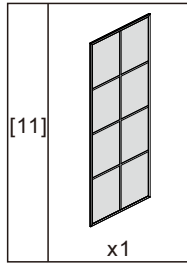
WHBW8	Size	L	
		Min.	Max.
	900mm	890mm	900mm
	1000mm	990mm	1000mm
	1200mm	1190mm	1200mm
	1400mm	1390mm	1400mm



02



[1]		x1
[2]		x1(ST4x30)
[6]		x1
[7]		x2(ST4x12)
[8]		x1
[9]		x1

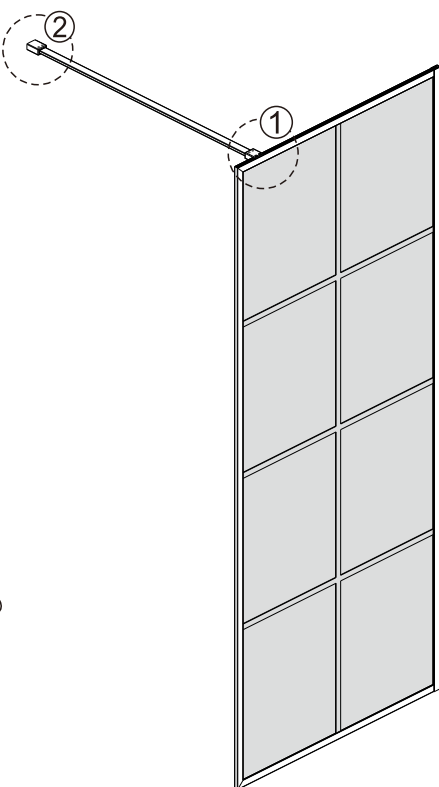
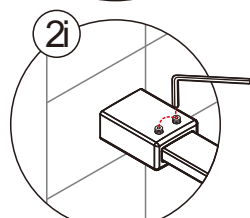
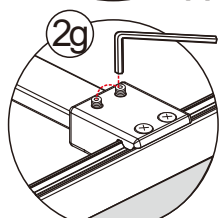
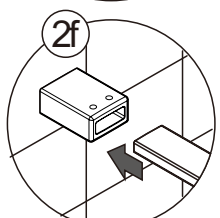
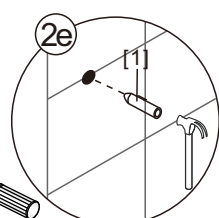
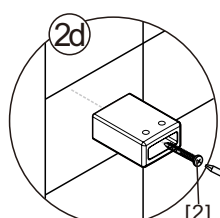
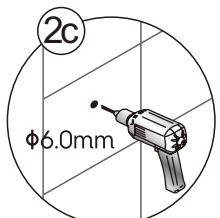
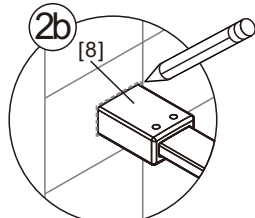
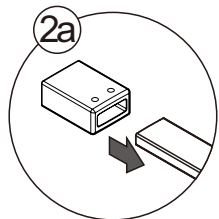
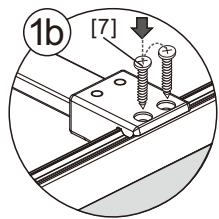
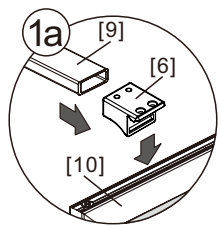

[3]		x3
[4]		x3(ST4x8)

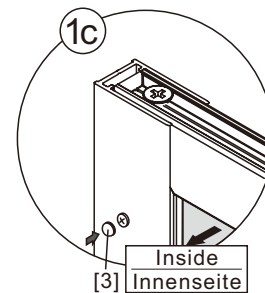
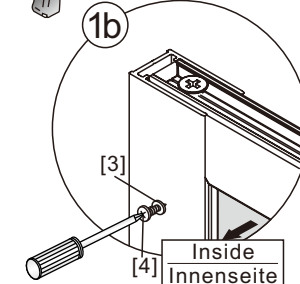
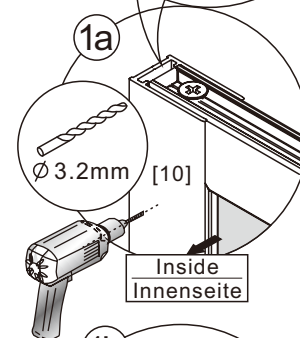
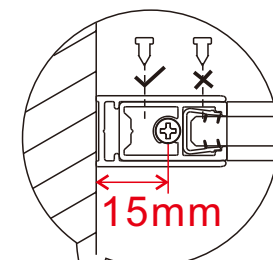
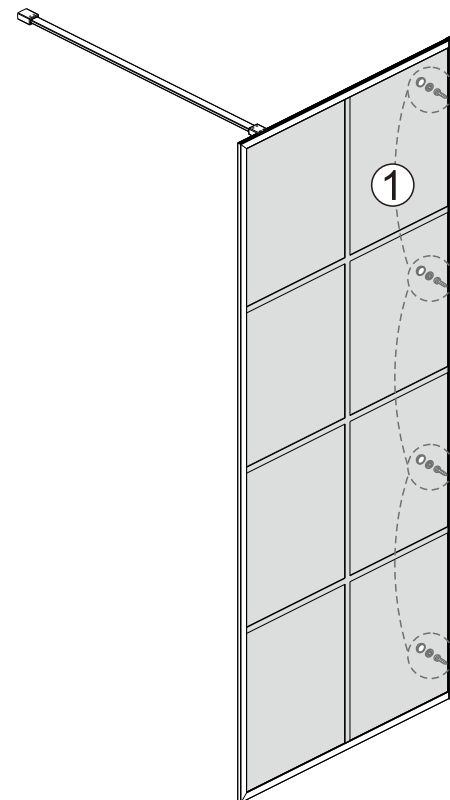

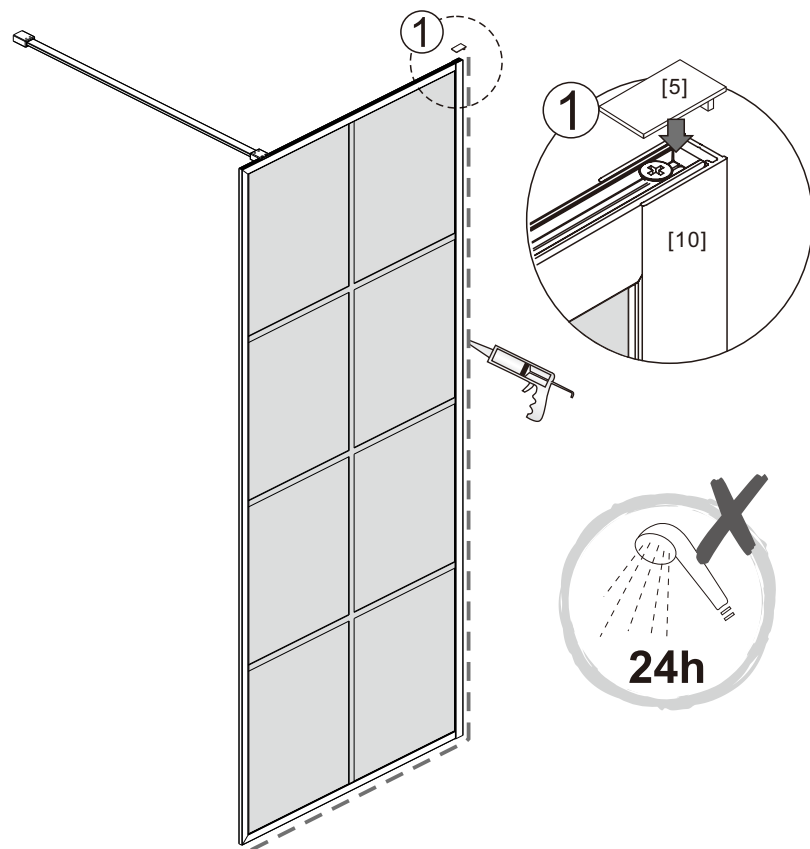

EN Do not use the shower enclosure for at least 24 hours in order to allow the silicone sealant to cure fully

DE Die Duschkabine darf innerhalb von mindestens 24 Stunden nicht benutzt werden, damit die Silikonversiegelung vollständig abbinden kann.



EN

The golden rules for care

NOTE: Use warm soapy water and a soft damp cloth to keep the glass clean. Wipe dry with a clean cloth. Glass cleaner can be used if required. Scourers, abrasives and chemical cleaners can damage the glass and pattern, and should not be used.

In hard water areas, insoluble lime salts may be deposited on the glass. If this is allowed to build up it becomes increasingly difficult to remove and looks unsightly. Regular cleaning will minimize this effect.

- Do not attempt to cut the glass.
- Do not strike the glass with hard or pointed items.
- Regularly check moving parts such as rollers and hinges to ensure they are secure and adjusted correctly. Tighten and adjust where required. Also check all sealed joints to ensure seal has not deteriorated. Re-seal if required.

DE

Die goldenen Regeln der Pflege

HINWEIS: Zum Reinigen des Glases warme Seifenlauge und einen weichen, feuchten Lappen benutzen. Mit einem trockenen Lappen trockenwischen. Bei Bedarf kann Glasreiniger verwendet werden. Scheuerschwämme, Scheuermittel und chemische Reiniger können das Glas und die Musterung angreifen und sollten daher nicht benutzt werden.

In Gebieten mit hartem Wasser können sich Kalkablagerungen am Glas bilden. Wenn diese nicht beseitigt werden und sich immer weiter Kalk ablagert, wird es umso schwieriger, die Kalkreste zu entfernen. Nach einiger Zeit wirken diese verkalkten Stellen unansehnlich. Durch regelmäßiges Reinigen kann dem vorgebeugt werden.

- Nicht das Glas anschneiden.
- Nicht mit harten oder spitzen Gegenständen gegen das Glas stoßen.
- Bewegliche Teile wie Rollen und Scharniere regelmäßig auf festen Sitz und richtige Justage überprüfen. Ggf. nachstellen und nachziehen. Außerdem alle versiegelten Übergänge prüfen, um festzustellen, ob die Dichtungen noch intakt sind. Ggf. nachdichten.