

# SFTR

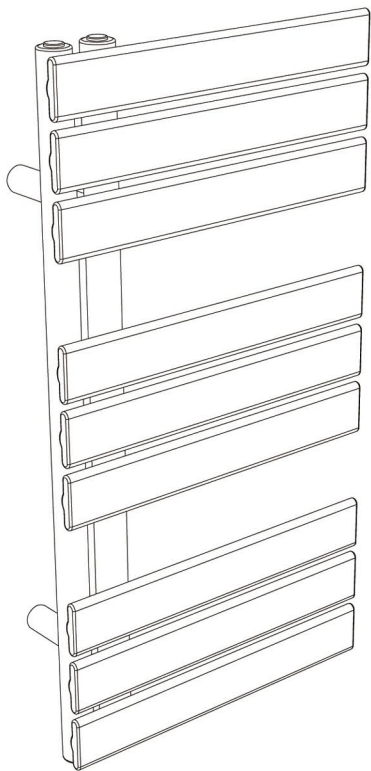

## **Installation Instructions**

( Central Heating)

## **Installationsanleitung**

(Zentralheizung)

## **Instructions d'installation**

(Chauffage central)

## **Instrucciones de instalación**

(Calefacción central)

## **Istruzioni per l'installazione**

(Riscaldamento centrale)

## 1 Product Information







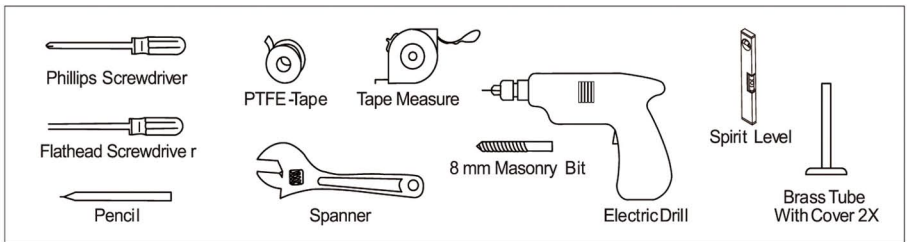



- Please read this instruction carefully before installation.
- Installation should be carried out by a qualified plumber.



### Preparation



### Product parts

 Towel Rail <b>[A]x1</b>	 Blanking Plug <b>[B]x1</b>	 Air Vent <b>[C]x1</b>	
 Rubber Ring <b>[D]x4</b>	 Wall Support <b>[E]x4</b>	 Rawlplug <b>[F]x4</b>	 Long Screw <b>[G]x4</b>
 Small Screw <b>[H]x4</b>	 Spacer <b>[I]x4</b>	 Bolt <b>[J]x4</b>	 Plastic Screw <b>[K]x2</b>

## 2 Installation

**Step 1:** Select your desired installation position and ensure the wall is sufficiently strong to hold the weight of the radiator. (Brick or breezeblock wall is ideal.)

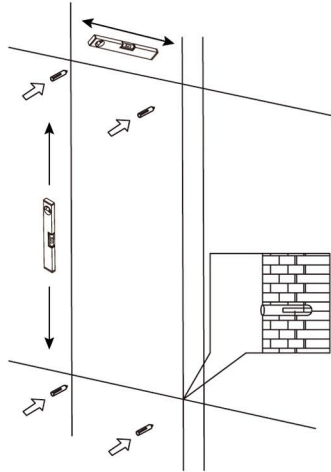
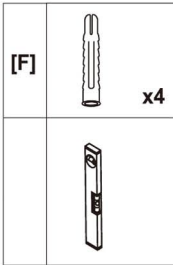

Mark down the screw position on the wall, then drill four holes accordingly and tap the Rawplug F into the wall.

**Step 2:** Connect the Wall Support E to the wall with Long Screws G.

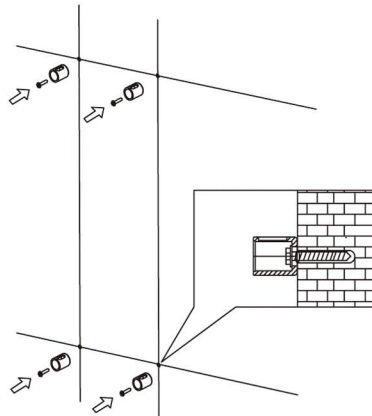
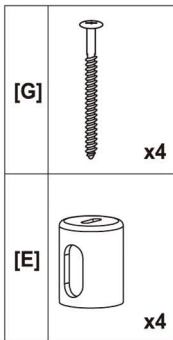

**Step 3:** Fix the spacer I to the radiator with bolts J.

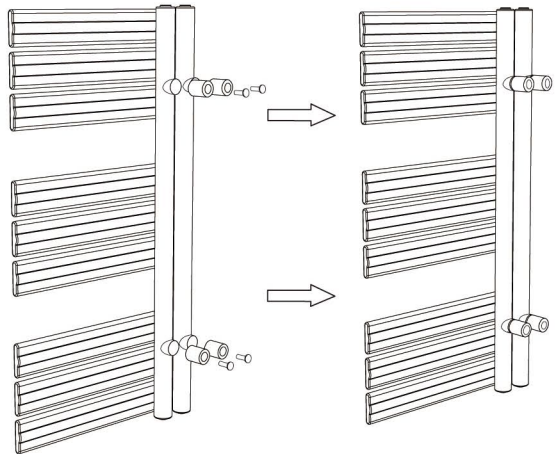
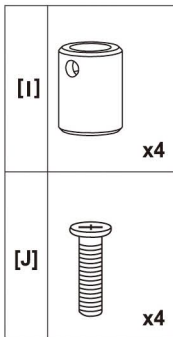

**Step 4:** Mount the radiator to the wall and tighten the Small Screws H in the brackets.

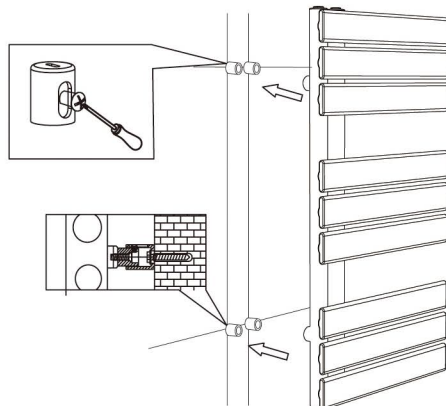
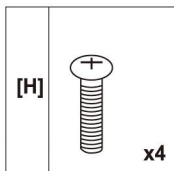

## After installation ..

- Use a screwdriver to open the air vent, open the valve and let the water rush into the towel warmer. Check all connections for leaks.
- Once water overflows from the air vent, there is no air in the tube.
- Use a screwdriver to close the air vent, turn on the valve and the towel warmer is ready for use.

## After care ...

- Classic towel warmers are made from steel with color painting, and should not be cleaned with corrosive or scouring cleaning agents.

## Please note...

- This product can only be used at  $P_N \leq 0.6 \text{ MPa}$  (6 Bar), It should only be filled with water, and at a temperature below  $100 \text{ }^\circ\text{C}$  ( $212^\circ\text{F}$ ) . See table below for installation requirements.
- If the temperature exceeds  $48 \text{ }^\circ\text{C}$  (oder  $120^\circ\text{F}$ ), please show a warning sign near the product to avoid burning and scolding accidents.

Fill 3/4 Full	Pressure	Temperature	Comments
Water only	$P_N \leq 0.6 \text{ Mpa}$	$0^\circ\text{C} < t \leq 100^\circ\text{C}$	If ambient temperature drops below $1 \text{ }^\circ\text{C}$ , drain out the water to prevent freezing

## 1 Produktinformationen







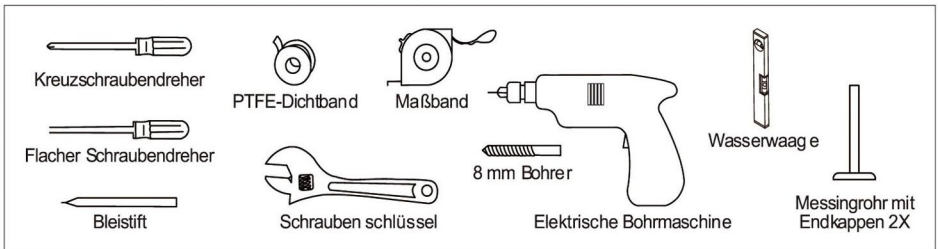



- Die Installation sollte von einer entsprechend qualifizierten Person durchgeführt werden.
- Entsorgen Sie die Verpackung auf verantwortungsvolle Weise



### Vorbereitung

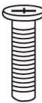

### Produktteile

 Badheizkörper [A]x1	 Blindstopfen [B]x1	 Entlüftung [C]x1	
 Gummi Ring [D]x4	 Wandhalterung [E]x4	 Dübel [F]x4	 Lange Schraube [G]x4
 Kleine Schraube [H]x4	 Abstandshalter [I]x4	 Bolzen [J]x4	 Plastik Stopfen [K]x2

## 2 Installation

**Schritt 1:** Wählen Sie die gewünschte Einbaulage und stellen Sie sicher, dass die Wand starkgenug ist, um das Gewicht des Badheizkörpers zu tragen. Die Mauer aus Ziegeln oder Brisenblock ist ideal.

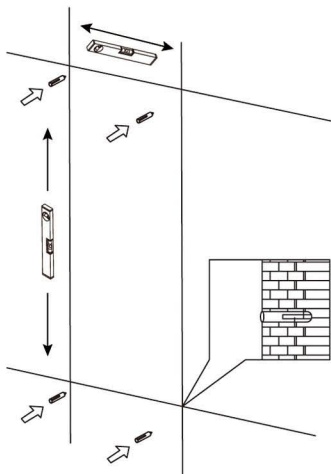
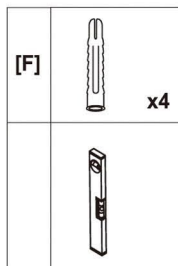

Markieren Sie die Schraubenposition an der Wand, bohren Sie dann vier Löcher entsprechend und klopfen Sie den Rawplug F in die Wand.

**Schritt 2:** Verbinden Sie die Wandhalterung E mit langen Schrauben G mit der Wand.

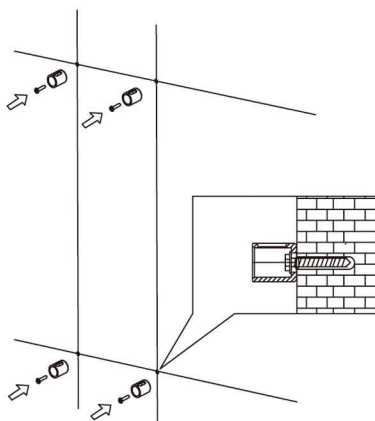
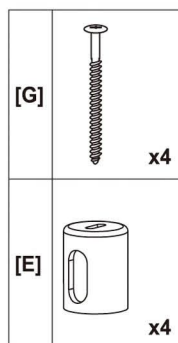

**Schritt 3:** Befestigen Sie den Abstandshalter I mit den Schrauben JamHeizkörper.

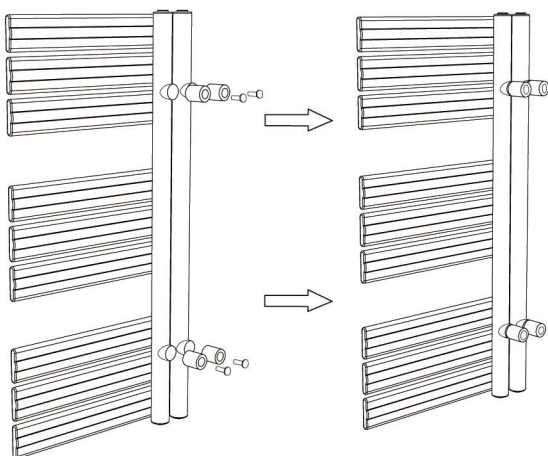
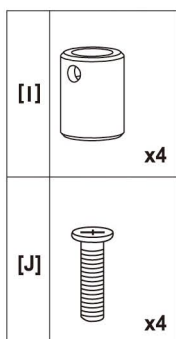

**Schritt 4:** Montieren Sie den Heizkörper an der Wand und ziehen Sie die kleinen Schrauben H in den Halterungen fest.

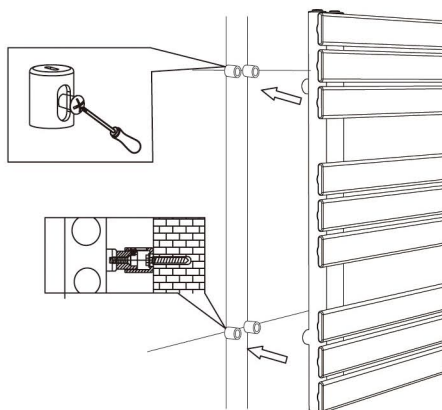
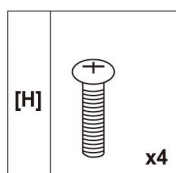



## Nach der Installation:

- Öffnen Sie mit einem Schraubendreher das Luftventil, öffnen Sie das Ventil und lassen Sie das Wasser in den Heizkörper strömen.  
Überprüfen Sie alle Anschlüsse, ob sie dicht sind.
- Sobald Wasser aus dem Luftventil überläuft, befindet sich keine Luft mehr in den Röhren.
- Mit einem Schraubendreher das Luftventil schließen, das Ventil einschalten und der Heizkörper ist jetzt betriebsbereit.

## Pflege:

- Klassische Heizkörper bestehen aus Lackieranlagen und sollten nicht mit ätzenden oder scheuernden Reinigungsmitteln gereinigt werden.

## Bitte beachten Sie..

- Dieses Produkt kann nur bei  $P_N \leq 0.6 \text{ MPa}$  (6 Bar) verwendet werden. Es sollte nur mit Wassergefüllt werden und bei einer Temperatur unter  $100^\circ\text{C}$  ( $212^\circ\text{F}$ ). In der folgenden Tabelle finden Sie die Installationsanforderungen.
- Wenn die Temperatur  $48^\circ\text{C}$  (oder  $120^\circ\text{F}$ ) überschreitet, zeigen Sie bitte ein Warschild in der Nähe des Produkts, um Verbrennungen und Schelteinwirkungen zu vermeiden.

Fülle Sie 3/4 voll	Druck	Temperatur	Bemerkungen
Nur Wasser	$P_N \leq 0.6 \text{ Mpa}$	$0^\circ\text{C} < t \leq 100^\circ\text{C}$	Wenn die Umgebungstemperatur unter $1^\circ\text{C}$ fällt, lassen Sie das Wasser ab, um ein Einfrieren zu verhindern.

## 1 Informations sur le produit







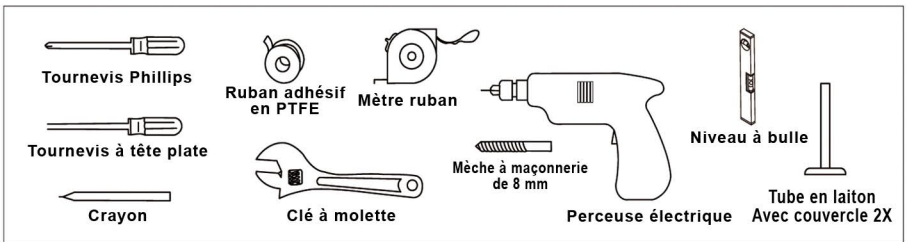



- Veuillez lire attentivement ces instructions avant l'installation.
- L'installation doit être effectuée par un plombier qualifié.



### Préparation



### Pièces du produit

 Porte-serviettes [A]x1	 Bouchon d'obturation [B]x1	 Event d'air [C]x1	
 Anneau en caoutchouc [D]x4	 Support mural [E]x4	 Bouchon Rawlplug [F]x4	 Vis longue [G]x4
 Petite vis [H]x4	 Entretoise [I]x4	 Boulon [J]x4	 Vis en plastique [K]x2

## 2 Installation

**Étape 1:** Choisissez la position d'installation souhaitée et assurez-vous que le mur est suffisamment solide pour supporter le poids du radiateur. (Un mur en briques ou en parpaings est idéal).

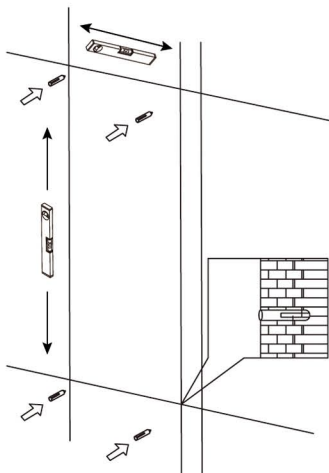
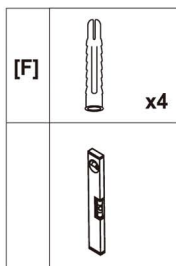

Marquez la position de la vis sur le mur, puis percez quatre trous en conséquence et tapez le Rawlplug F dans le mur.

**Étape 2:** Fixez le support mural E au mur à l'aide des longues vis G.

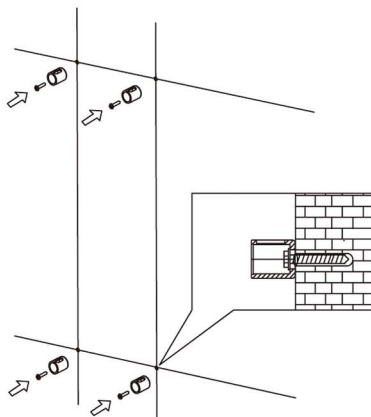
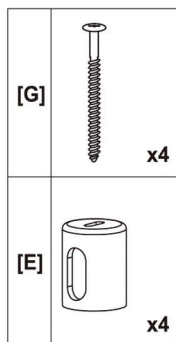

**Étape 3:** Fixez l'entretoise I au radiateur à l'aide des boulons J.

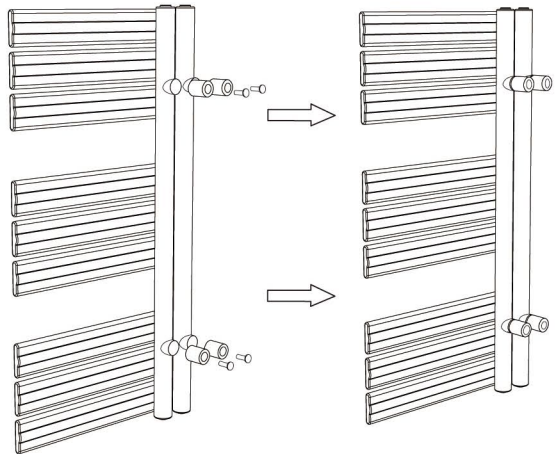
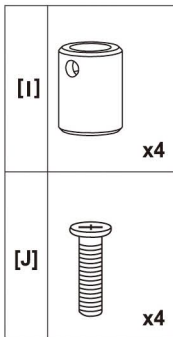

**Étape 4:** Fixez le radiateur au mur et serrez les petites vis H dans les supports.

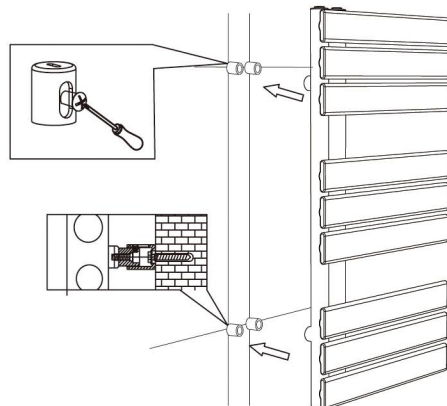
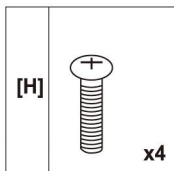

## Après l'installation ...

- Utilisez un tournevis pour ouvrir l'évent d'air, ouvrez la vanne et laissez l'eau s'engouffrer dans le radiateur sèche-serviettes. Vérifiez l'étanchéité de tous les raccords.
- Une fois que l'eau déborde de l'évent d'air, il n'y a plus d'air dans le tube.
- Utilisez un tournevis pour fermer l'évent d'air, ouvrez la valve et le radiateur de serviettes est prêt à être utilisé.

## Après l'entretien ...

- Les chauffe-serviettes classiques sont fabriqués en acier chromé et ne doivent pas être nettoyés avec des produits corrosifs ou récurants.

## Veillez noter ...

- Ce produit ne peut être utilisé qu'à  $PN \leq 0,6 \text{ MPa}$  (6 Bar), Il ne doit être rempli que d'eau, et à une température inférieure à  $100 \text{ }^\circ\text{C}$  ( $212 \text{ }^\circ\text{F}$ ) . Voir le tableau ci-dessous pour les exigences d'installation.
- Si la température dépasse  $48 \text{ }^\circ\text{C}$  (ou  $120 \text{ }^\circ\text{F}$ ), veuillez montrer un panneau d'avertissement près du produit pour éviter les accidents de brûlure et de grondement.

Remplir à 3/4	Pression	Température	Commentaires
Eau seulement	$PN \leq 0,6 \text{ Mpa}$	$0 \text{ }^\circ\text{C} \leq t \leq 100 \text{ }^\circ\text{C}$	Si la température ambiante descend en dessous de $1 \text{ }^\circ\text{C}$ , veuillez vidanger l'eau pour éviter le gel.

## 1 Información sobre el producto

- Por favor, lea atentamente estas instrucciones antes de la instalación.
- La instalación debe ser realizada por un fontanero cualificado.



### Preparación

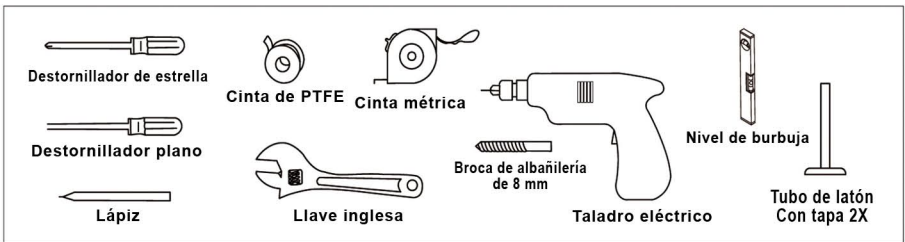

### Partes del producto

<p>Toallero</p> <p>[A]x1</p>	<p>Tapón ciego</p> <p>[B]x1</p>	<p>Ventilación</p> <p>[C]x1</p>	
<p>Anillo de goma</p> <p>[D]x4</p>	<p>Soporte de pared</p> <p>[E]x4</p>	<p>Tapón Rawiplug</p> <p>[F]x4</p>	<p>Tornillo largo</p> <p>[G]x4</p>
<p>Tornillo pequeño</p> <p>[H]x4</p>	<p>Espaciador</p> <p>[I]x4</p>	<p>Perno</p> <p>[J]x4</p>	<p>Tornillo de plástico</p> <p>[K]x2</p>

## 2 Instalación

**Paso 1:** Seleccione la posición de instalación deseada y asegúrese de que la pared es lo suficientemente fuerte como para soportar el peso del radiador. (Lo ideal es una pared de ladrillos o de bloques de brisa).

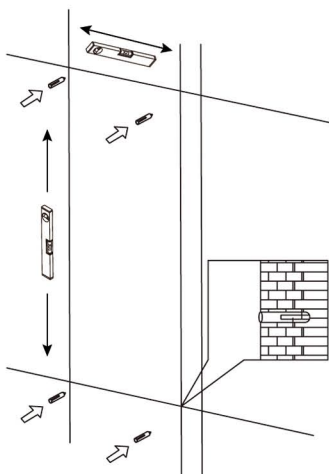
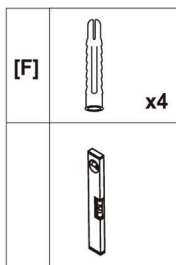

Marque la posición de los tornillos en la pared, luego perforo cuatro agujeros en consecuencia y golpee el Rawlplug F en la pared.

**Paso 2:** Conecte el soporte de pared E a la pared con los tornillos largos G.

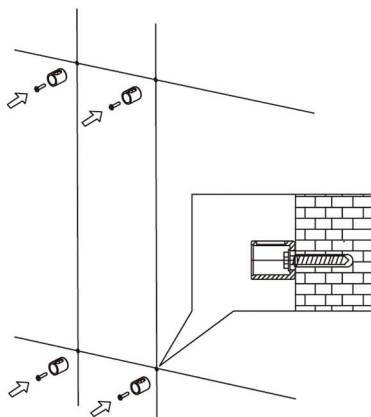
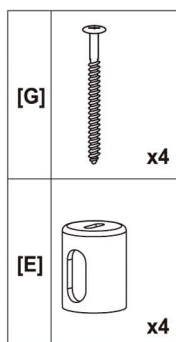

**Paso 3:** Fijar el espaciador I al radiador con los tornillos J.

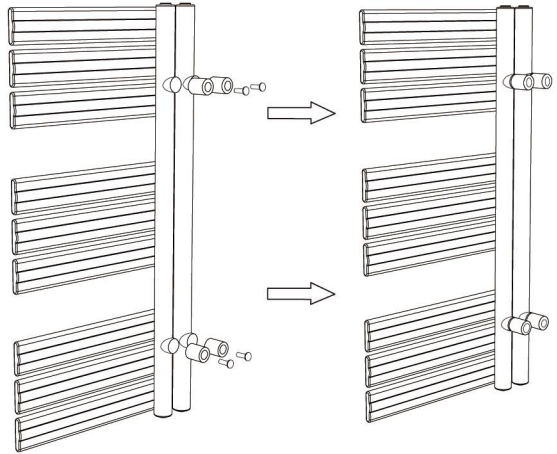
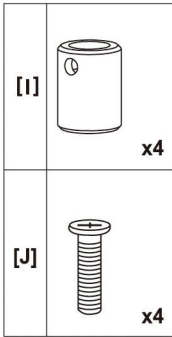

**Paso 4:** Monte el radiador en la pared y apriete los tornillos pequeños H en los soporte.

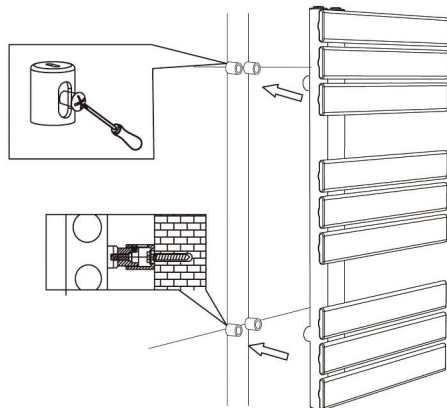
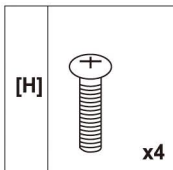



## Después de la instalación ...

- Utilice un destornillador para abrir el respiradero, abra la válvula y deje que el agua entre en el calentador de toallas. Compruebe que no haya fugas en todas las conexiones.
- Una vez que el agua rebosa por el respiradero, no hay aire en el tubo.
- Utilice un destornillador para cerrar el respiradero, abra la válvula y el calentador de toallas estará listo para su uso.

## Cuidados posteriores ...

- Los calentadores de toallas Classic están fabricados en acero cromado y no deben limpiarse con productos de limpieza corrosivos o abrasivos.

## Tenga en cuenta ...

- Este producto sólo puede utilizarse a  $PN \leq 0,6 \text{MPa}$  (6 Bar), Sólo debe llenarse con agua, y a una temperatura inferior a  $100 \text{ }^\circ\text{C}$  ( $212^\circ\text{F}$ ). Consulte la tabla siguiente para conocer los requisitos de instalación.
- Si la temperatura supera los  $48 \text{ }^\circ\text{C}$  (o  $120^\circ\text{F}$ ), por favor, muestre una señal de advertencia cerca del producto para evitar accidentes de quemaduras y resacaños.

Llenar 3/4 de su capacidad	Presión	Temperatura	Comentarios
Sólo agua	$PN \leq 0,6 \text{Mpa}$	$0^\circ\text{C} < t \leq 100^\circ\text{C}$	Si la temperatura ambiente desciende por debajo de $1 \text{ }^\circ\text{C}$ , por favor, drene el agua para evitar la congelación

## 1 Informazioni sul prodotto







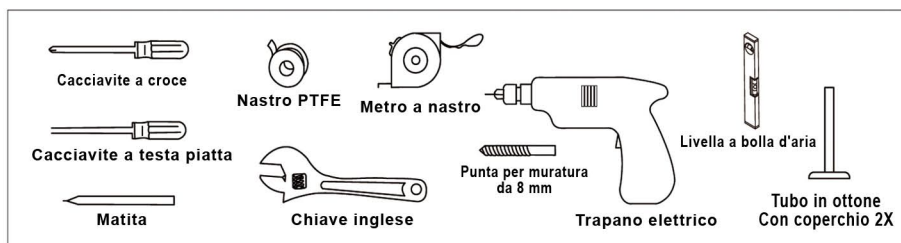



- Leggere attentamente le istruzioni prima dell'installazione.
- L'installazione deve essere eseguita da un idraulico qualificato.



### Preparazione



### Parti del prodotto

 Guida per asciugamani [A]x1	 Tappo di chiusura [B]x1	 Bocchetta d'aria [C]x1	
 Anello in gomma [D]x4	 Supporto a parete [E]x4	 Tappo a vite [F]x4	 Vite lunga [G]x4
 Vite piccola [H]x4	 Distanziatore [I]x4	 Bullone [J]x4	 Vite di plastica [K]x2

## 2 Installazione

**Fase 1:** Scegliere la posizione di installazione desiderata e assicurarsi che la parete sia sufficientemente robusta da sostenere il peso del radiatore. (L'ideale è una parete in mattoni o in legno.)

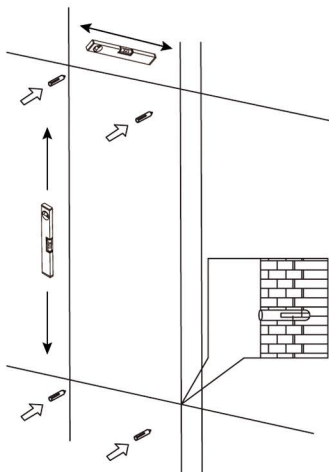
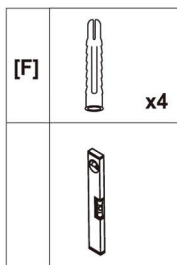

Segnare la posizione delle viti sulla parete, quindi praticare quattro fori di conseguenza e inserire il Rawplug F nella parete.

**Fase 2:** Collegare il supporto a parete E alla parete con le viti lunghe G.

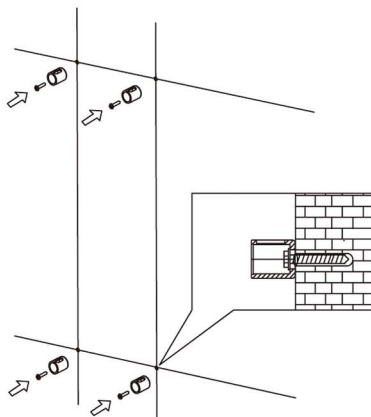
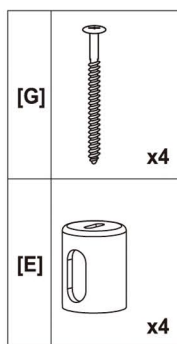

**Passo 3:** Fissare il distanziale I al radiatore con i bulloni J.

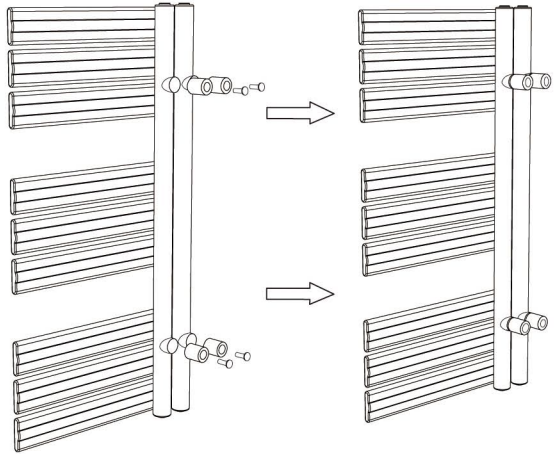
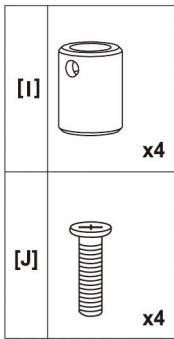

**Passo 4:** Montare il radiatore alla parete e stringere le viti piccole H nelle staffe.

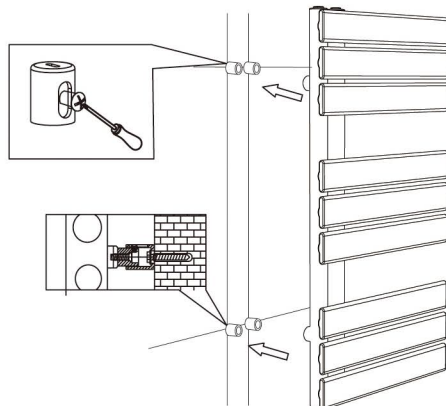
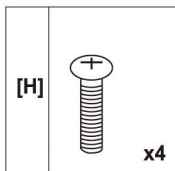

## Dopo l'installazione ...

- Aprire lo sfiato con un cacciavite, aprire la valvola e far affluire l'acqua nello scaldasalviette. Controllare che tutti i collegamenti non presentino perdite.
- Una volta che l'acqua trabocca dallo sfiato, non c'è aria nel tubo.
- Con un cacciavite chiudere lo sfiato, riaprire la valvola e lo scaldasalviette è pronto per l'uso.

## Cura ...

- Gli scaldasalviette Classic sono realizzati in acciaio cromato e non devono essere puliti con detergenti corrosivi o abrasivi.

## Attenzione ...

- Questo prodotto può essere utilizzato solo a  $PN \leq 0,6 \text{MPa}$  (6 Bar), deve essere riempito solo con acqua e a una temperatura inferiore a  $100 \text{ }^\circ\text{C}$  ( $212^\circ\text{F}$ ). Per i requisiti di installazione, vedere la tabella seguente.
- Se la temperatura supera i  $48 \text{ }^\circ\text{C}$  (o  $120 \text{ }^\circ\text{F}$ ), si prega di esporre un cartello di avvertimento vicino al prodotto per evitare bruciature e incidenti.

Riempire per 3/4	Pressione	Temperatura	Commenti
Solo acqua	$PN \leq 0,6 \text{Mpa}$	$0^\circ\text{C} < t \leq 100^\circ\text{C}$	Se la temperatura ambiente scende al di sotto di $1 \text{ }^\circ\text{C}$ , scaricare l'acqua per evitare il congelamento

