



SECURITY CAMERA TESTER

IPC-9800 Plus+ Series User Manual



IPC-9800 Plus+
IPC-9800ADH Plus+
IPC-9800ADHS Plus+

IPC-9800C Plus+
IPC-9800ADHC Plus+
IPC-9800ADHSC Plus+
IPC-9800MOVTADHS Plus+

V01.00

- Thank you for purchasing the Rsrting IP camera tester. Please read the manual before using the IP camera tester and use properly. We have built this user manual in the tester, you can also view it on your tester.
- For using the IP camera tester safely, please first read the 「Safety Information」 carefully in the manual.
- If the functions marked with * or / multi-options in the manual are differentiated functions. Whether you have this function depends on the model you purchased.
- The manual should be kept well in case of reference.
- Keep the S/N label for after-sale service within warranty period. Product without S/N label will be charged for repair service.
- If there is any question or problem while using the IP camera tester, or damages occurred on the product, please contact our After-sales service department service@rsrteng.com or view WWW.RSRTENG.COM.

Content

1. Safety information	1
2. IP Camera Tester Introduction	
2.1 General	2
2.2 Model feature comparison.....	3
2.3 Packing list	3
2.4 Function interface	4
3. Operation	
3.1 Installing the Battery	7
3.2 Instrument connection	8
3.2.1 IP camera connection	8
3.2.2 Analog camera connection	9
3.2.3 HD Coaxial camera connection	10
3.2.4 HDMI IN.....	10
3.2.5 HDMI output.....	11
3.3 OSD menu	11
3.3.1 Drop-down Menu	11
3.3.2 Short cut-menu	12
3.3.3 Screen capture	13
3.3.4 Link monitor	13
3.3.5 TesterPlay	15
3.3.6 IPC test pro	16
3.3.7 IP discovery	20
3.3.8 Rapid ONVIF test	21
3.3.9 NON ONVIF.....	33
3.3.10 HDMI IN (*Optional).....	35
3.3.11 Analog camera test.....	38
3.3.12 Color-bar generator (TV OUT)	46
3.3.13 AutoHD (*Optional)	47

3.3.14 HD Coaxial & Analog level test (*Optional).....	47
3.3.15 SDI Camera Test (*Optional).....	49
3.3.16 CVI camera test (*Optional).....	50
3.3.17 TVI camera test (*Optional).....	57
3.3.18 AHD camera test (*Optional).....	59
3.3.19 NET TOOL PRO.....	60
(1) IP address scan.....	60
(2) PING Test.....	61
(3) Network test (Ethernet bandwidth test).....	61
(4) Port Flashing.....	64
(5) DHCP server.....	65
(6) Trace route.....	66
(7) Link monitor.....	66
3.3.20 PoE power / DC12V 3A and DC 5V 2A USB power output.....	67
3.3.21 DC 24V 2A power output.....	68
3.3.22 Cable Test.....	69
3.3.23 RJ45 cable TDR test.....	72
3.3.24 Cable Tracer (*Optional).....	74
3.3.25 TDR cable test (*Optional).....	75
3.3.26 BNC attenuation test (*Optional).....	78
3.3.27 PoE Voltage test.....	80
3.3.28 12V power input test.....	81
3.3.29 Digital Multi-meter (*Optional).....	81
3.3.30 Optical power meter (*Optional).....	89
3.3.31 Visual Fault Locator (*Optional).....	91
3.3.32 Audio Record.....	92
3.3.33 Data monitor.....	92
3.3.34 Audio player.....	93
3.3.35 Media Player.....	93

3.3.36 RTSP Player.....	94
3.3.37 Hik test tool.....	95
3.3.38 Dahua test tool	99
3.3.39 Update.....	105
3.3.40 Office.....	105
3.3.41 LED Flashlight.....	106
3.3.42 Browser.....	107
3.3.43 Notepad.....	107
3.3.44 System Setting.....	108
3.3.45 File explorer.....	113
3.3.46 Theme	114
3.3.47 Audio test.....	116
4. Specifications	
4.1 General Specifications	116
4.2 Multi-meter specifications	120
4.3 Optical power meter specifications	123
4.4 Visual fault locator specifications	123
5. Contact us.....	124

1. Safety information

- ◆ The tester is intended to use in compliance with the local rules of the electrical usage and avoid to apply at the places which are inapplicable for the use of electrics such as hospital, gas station etc.
- ◆ To prevent the functional decline or failure, the product should not be sprinkled or damped.
- ◆ The exposed part of the tester should not be touched by the dust and liquid.
- ◆ During transportation and use, it is highly recommended to avoid the violent collision and vibration of the tester, lest damaging components and causing failure.
- ◆ Don't leave the tester alone while charging and recharging. If the battery is found severely hot, the tester should be powered off from the electric source at once. The tester should not be charged over 8 hours.
- ◆ Don't use the tester where the humidity is high. Once the tester is damp, power off immediately and move away other connected cables.
- ◆ The tester should not be used in the environment with the flammable gas.
- ◆ Do not disassemble the instrument since no component inside can be repaired by the user. If the disassembly is necessary indeed, please contact with the technician of our company.
- ◆ The instrument should not be used under the environment with strong electromagnetic interference.
- ◆ Don't touch the tester with wet hands or waterish things.
- ◆ Don't use the detergent to clean and the dry cloth is suggested to use. If the dirt is not easy to remove, the soft cloth with water or neutral detergent can be used. But the cloth should be tweaked sufficiently.

About Digital Multi-meter

- ◆ Before using, you must select the right input jack, function and range.
- ◆ Never exceed the protection limit values indicated in specifications for each range of measurement.
- ◆ When the tester is linked to a measurement circuit, do not touch unused terminals.
- ◆ Do not measure voltage if the voltage on the terminals exceeds 660V above earth ground.
- ◆ At the manual range, when the value scale to be measured is unknown beforehand, set the range selector at the highest position.
- ◆ Always be careful when working with voltages above 60V DC or 40V AC, keep fingers behind the

probe barriers while measuring.

- ◆ Never connect the meter with any voltage source while the function switch is in the current, resistance, capacitance, diode, continuity, otherwise it will damage the meter.
- ◆ Never perform capacitance measurements unless the capacitor to be measured has been discharged fully.
- ◆ Never measure any of resistance, capacitance, diode or continuity measurements on live circuits.

Visual laser sources

When you turn on visual laser sources, please don't stare at it, or will damage to eyes

When not using it, please turn it off and cover the protective cap.

2. IP Camera Tester Introduction

2.1 General

The Rsrteng 7 inch touch screen IP camera tester is designed for maintenance and installation of 4K 12MP IP cameras, analog CVBS cameras, 8MP TVI, 8MP CVI, 8MP AHD, 8MP EX-SDI cameras, as well as testing 4K H.264 /4K H.265 camera via mainstream, The 1920x1200 resolution enables it to display network HD cameras and analog cameras in high resolution. The unit supports many ONVIF PTZ and analog PTZ control. The combination of touch screen and key buttons make the IP camera tester very user-friendly.

The tester is also a great tool for Ethernet network testing. It can test PoE power voltage, PING, and IP address searching. You can use the blue cable tracer to locate individual connected cables from a bundle of cables. Test LAN cable for proper connection termination. Other functions include providing 25.5W PoE power to your camera, HDMI IN and OUT, CVBS loop test, testing IP and analog at the same time, LED Flashlight, DC 12V 3A, DC 24V 2A, power output and much more. Its portability, user-friendly design and many other functions make the IP tester an essential tool for all installers or technicians.

2.2 Model feature comparison

The IPC-9800 Plus+ series has multiple models, this manual lists all the functions of the tester, but does not mean that your tester has all the functions in the user manual. Except for IPC-9800MOVTADHS Plus+, other models will not support some of these functions, it depends on the model you purchased.

You can see the difference between different models from the table.

Model \ Feature	IPC-9800 Plus+	IPC-9800C Plus+	IPC-9800ADH Plus+	IPC-9800ADHC Plus+	IPC-9800ADHS Plus+	IPC-9800ADHSC Plus+	IPC-9800MOVTADHS Plus+
IP camera test	✓	✓	✓	✓	✓	✓	✓
CVBS camera test	✓	✓	✓	✓	✓	✓	✓
HD AHD camera test	N/A	N/A	✓	✓	✓	✓	✓
HD CVI camera test	N/A	N/A	✓	✓	✓	✓	✓
HD TVI camera test	N/A	N/A	✓	✓	✓	✓	✓
HD SDI camera test	N/A	N/A	N/A	N/A	✓	✓	✓
Digital multimeter	N/A	N/A	N/A	N/A	N/A	N/A	✓
Optical power meter	N/A	N/A	N/A	N/A	N/A	N/A	✓
Visual laser sources	N/A	N/A	N/A	N/A	N/A	N/A	✓
TDR cable test	N/A	N/A	N/A	N/A	N/A	N/A	✓
HDMI input&output	Only output	Only output	✓	✓	✓	✓	✓
With Cable tracer	*	✓	*	✓	*	✓	✓

Explanation: ✓: indicates support, *: indicates optional, N/A: indicates don't support















2.3 Packing list

- 1). Tester
- 2). Adaptor DC12V 2A

- 3). Network cable tester
- 4). Polymer lithium ion battery (7.6V DC 7800mAh)
- 5). BNC cable
- 6). RS485 cable
- 7). SC, ST connector (Only for optical power meter)
- 8). Multi-meter test leads one pair of red and black (only for the Multi-meter models)
- 9). Output Power cable
- 10). Audio cable
- 11). TDR alligator clamp (only for TDR models)
- 12). 8GB SD card
- 13). Safety cord
- 14). Tool bag
- 15). Manual

2.4 Function interface



1		Press more than 2 seconds, turn on or off the device, short press to turn on or off the menu display
2		Menu key, press it to call short- menu.
3		4xzoom the image displays.
4		Far focus: Focus the image faraway
5		Near focus: Focus the image nearby
6		TELE: zoom in the image
7		WIDE: zoom out the image
8		Open/set, Confirm the setting of parameters, open or enlarge the aperture
9		Return/Close: Return or cancel while setting parameters of the menu, close or decrease the aperture
10		Upward, set function or add parameter. Tilt the PTZ upward
11		Rightward, select the parameter whose value will be changed. Add the value of the parameter. Pan the PTZ right
12		Downward, set function or reduce the value of the parameter. Tilt the PTZ downward
13		Leftward, select the parameter whose value will be changed
14		Confirm key,(Long press it to capture screen interface)
15		Return/Close : Return or cancel while setting parameters of the menu, close or decrease the aperture
16		Multi meter interface (Optional)
17		The charge indicator: it lights red while the battery is being charged. As the charging is complete, the indicator turns off automatically
18		The RS485 data transmission indicator: it lights red while the data is being transmitted
19		The data received indicator: it lights red while the data is being received
20		The power indicator: it lights green while the tester is powered by the adapter

Top interface



Bottom interface



- | | |
|----|--|
| 21 | Visible red laser source emits Interface (Optional) |
| 22 | DC12V 3A power output, for provisional DC power supply |
| 23 | HDMI IN (Optional) |
| 24 | CVBS IN/AHD/TVI/CVI Coaxial interface /(BNC interface) (AHD /TVI/CVI (Optional) |
| 25 | Video signal output(BNC interface) / cable tracer interface |
| 26 | Optical power meter interface (Optional) |
| 27 | LED lamp |
| 28 | RS485 Interface: RS485communication for the PTZ |
| 29 | HD-SDI/EX-SDI input (BNC interface) (Optional) |

30	TDR cable test interface (Optional)
31	HDMI output interface
32	Micro SD card slot,(comes with 8GB, supports up to 32GB)
33	UTP cable port: UTP cable tester port/ Cable tracer port
34	PSE power sourcing equipment. Tests PoE voltage/LAN test port
35	PoE power supply output or LAN test port (Using test PoE or non-PoE IP camera)
36	Microphone
37	USB 5V 2A power output, transmit data.
38	DC 12V 2A charging interface.
39	DC 24V 2A output
40	Audio input/Audio output and earphone interface.

3. Operation

3.1 Installing the Battery

The tester has a built-in lithium-ion polymer rechargeable battery. For safety, the battery should be insulated during transportation. Before using the instrument, remove the battery insulation.

Normally, there is no need to insulate the battery during normal use, and the tester can be turned on or off by pressing  button continuously.



Notice: Please use the original adaptor and connected cable of the device!



When the battery icon is full or the charge indicator turns off automatically, indicate the battery charging is completed.



Notice: When the Charge Indicator  turns off, the battery is approximately 90% charged.

The charging time can be extended for about 1 hour and the charging time within 12 hours will not damage the battery.

Notice: Press the key several seconds to restore the default settings when the instrument works abnormally.

Multi-meter: the red and black multi-meter pen must insert the corresponding port.

Warnings: Instrument communication port is not permitted access circuit voltage over 6V, otherwise damage the tester.

Warnings: Not allow insert multi-meter pen in the current terminal to measure voltage.

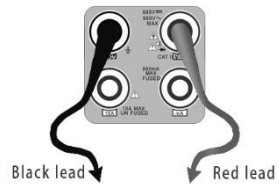

3.2 Instrument connection

3.2.1 IP camera connection

Power an IP camera with an independent power supply, then connect the IP camera to the IPC tester's LAN port, if the link indicator of the tester's LAN port is green and the data indicator flickers, it means the IP camera and the IPC tester are communicating. If the two indicators don't flicker, check if the IP camera is powered on or the network cable is not functioning properly.



Note: 1) If the IP camera requires PoE power, then connect the IP camera to the IP tester's LAN port . The tester will supply PoE Power for the IP camera. Click the icon POE to turn the PoE Power off or on.

2) If use the tester's menu to turn off the tester's PoE power supply, the PoE switch and the power sourcing equipment are allowed to connect to the tester's PSE port, and the PoE power will be supplied to the IP camera by the tester's LAN port. On this condition, the tester cannot receive data from IP camera, but the computer connected to the PoE switch can receive the data via the the tester.



Warning: PoE switch or PSE power sourcing equipment only can be connected to tester "PSE IN" port, otherwise will damage the tester.

3.2.2 Analog camera connection



- 1) Connect the camera's video output to the IP tester's VIDEO IN. The image will display on the tester after pushing the PTZ icon.
- 2) CCTV IP Tester "VIDEO OUT" interface connect to the Video input of monitor and optical video transmitter and receiver, the image display on the tester and monitor.
- 3) Connect the camera or the speed dome RS485 controller cable to the tester RS485 interface.(Note: positive and negative connection of the cable)

3.2.3 HD Coaxial camera connection

* SDI, CVI, TVI, AHD camera are classified as HD coaxial cameras. Hereby the following instruction of how to connect SDI camera to the tester is also applied to CVI, TVI, and AHD camera.



- 1) Connect the SDI camera's video output to the IP tester's "SDI IN" interface, the image will display on the tester. The tester only come with SDI input interface. There is no SDI output interface.
- 2) Connect the SDI camera or the speed dome RS485 controller cable to the tester RS485 interface.

3.2.4 HDMI IN



DVR/NVR or other device's HDMI out port connect to tester's HDMI in port, the meter will display input image. Support 4K 3840x2160P 30fps.

3.2.5 HDMI output

The built in HDMI output port can output live video from an analog or IP camera, recorded files, media files and images to HDTV monitors. Connect an HDMI cable from the IP tester to an HDTV monitor at any time. It supports up to 1080P resolution.

3.3 OSD menu

Press the key  2 seconds to turn on

Press the key  again to turn off

short press the key  to enter sleep mode, press it again to test.

If tester works abnormally and cannot be turned off, Press the key  several seconds to turn off, the tester reset.

3.3.1 Drop-down Menu

Press and slide at right top right corner twice to open shortcut menu. The shortcut menu includes POE power output, IP settings, Wi-Fi, HDMI IN, CVBS, Video OUT, LAN, Brightness, settings etc.

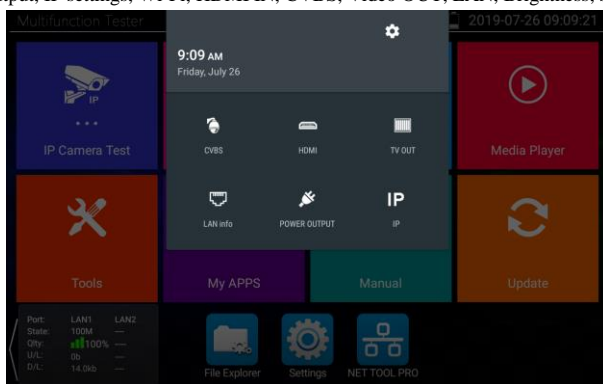

HDMI: Click HDMI IN to enter, In HDMI IN mode, it can converter test from analog to digital with dual test window IP & HDMI in or Analog & HDMI in.

CVBS: Click icon "CVBS"to enter, you can test IP and analog camera at the same time.

TV OUT: Click TV OUT to enter floating window, connecting the BNC cable to tester and appears analog video monitor interface, it can test circuit and BNC cable whether normal.

LAN: Display network port or WIFI connection real-time upload and download speeds and other

network parameters. **Settings:** Enter settings interface.

IP: Enter IP Settings interface. **POE power output:** Turn on or off the tester "PoE power" app.

3.3.2 Short cut-menu

You can call shortcut –menu by press tester's "menu" key, you can self- define shortcut -menu.

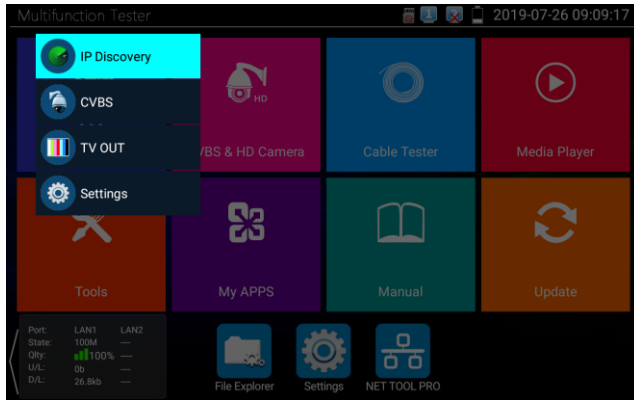

Press the key **(MENU)**, you can turn on it, and switch functions, then press **(🔍)** to enter app, tap other area on the screen, to exit the menu.

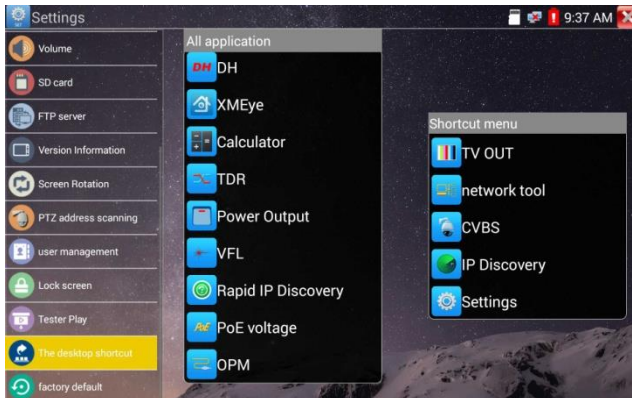

You can long press any app in the all applications list, it will auto move to shortcut menu . If delete any app in the shortcut menu, please select a app and press several seconds, it will be deleted.

3.3.3 Screen capture

Long press the key "enter", can capture screen interface and save it in any time.



You can go file management to view "file Explorer –sdcard- Pictures—Screenshots".

3.3.4 Link monitor

Tap icon "Link Monitoring" at left corner on the screen, to enter.

It can detect instrument port rate 10/100/1000M, signal quality detection, upload and download speed, etc. in real time. It can be used to detect whether the network video access bandwidth of devices such as NVR is normal.



When using a four-core cable to connect to a Gigabit device, would prompt "the link limited".



Advanced link monitor

It is for monitoring CVBS loop, Ethernet statistics, error frame statistics, frame length etc

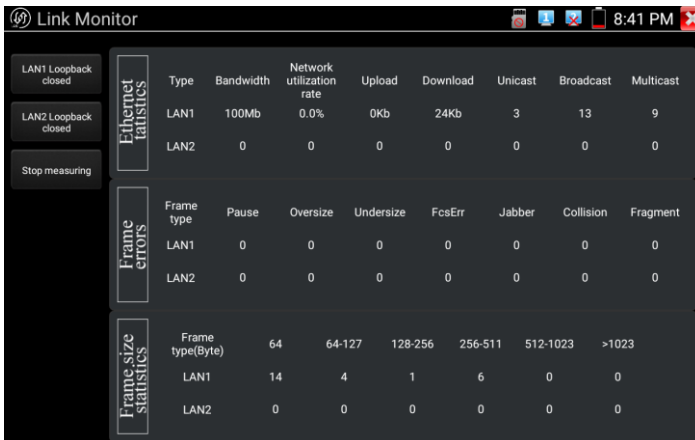

3.3.5 TesterPlay

Mobile screen projection (**Only for android version**)

The meter creates WIFI hotspot, connect mobile phone to the tester's WIFI hotspot, or the tester and mobile phone connect the same Wi-fi network. Download and install Remote control app to mobile phone, Tap icon "", select "TesterPlay" app, Click "Start" will create the RTSP URL.

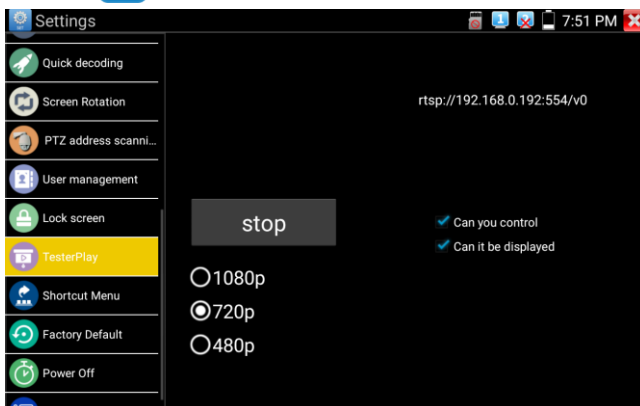

Mobile phone enter "Remote control" app, please click "Automatically search for IP" to search remote host IP, then click "Play" to display the real-time image and control IPC Tester.

If can't find the IP address, can click "Manually search for IP", and input tester's rtsp url to remote host IP, such as 192.168.0.186, then click "Play". Please contract supplier for Remote control APP.

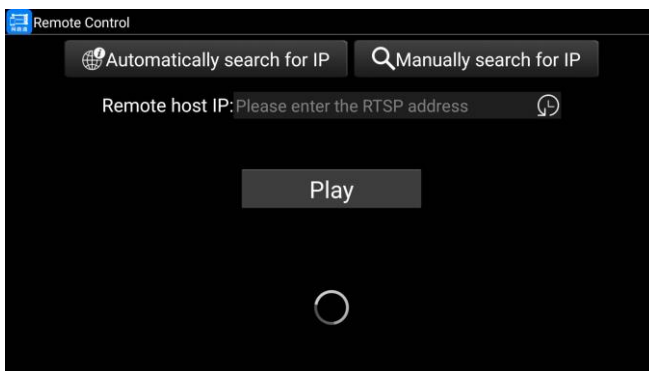



PC screen projection:

Install VLC player in the PC, turn on the VLC player "Media - Open Network Streaming", and input the RTSP address of on the top instrument two-dimensional code, click "play" to view the screen real-time projection.

3.3.6 IPC test pro

Camera test often need to open multiple apps, "IPC TEST PRO" app, using new technology and combine multiple functions to one APP, such as PoE ,DC 12V power information, IP scan and DHCP etc. It can improve working efficiency. Click icon  to enter

Power information

POE power: when entering "IPC test pro app", 48V PoE Auto-turn on, if exit it, Auto-turn off.

12V power: if the meter turn on, DC12V Auto-turn on, after enter "IPC test pro", support DC12V power output ,as well display power and voltage of DC12V power supply . (If select box, then exit not turn on PoE)

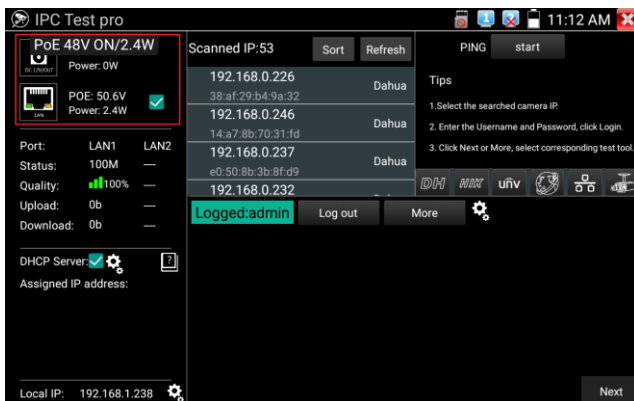

Networking information

Link status: 10/100/1000M Auto adapt, display the current network rate of the connected device.

Signal quality: the transmission quality of the currently connected network, normal is 100%.

Upload/Download rate: Real-time upload and download rate of the LAN and PSE IN port of the meter.

Practicability: connect the meter to the transmission channel between the hard disk or recorder and the camera, detect the real-time bandwidth traffic of the network and the hard disk recorder.

Checking bandwidth problems caused network or video recorder loss problems etc.

DHCP server: after entering “IPC test pro” app, the DHCP Auto-turn on. Go “Assigned IP “-IP Info., click icon “” to enter “Network tool-DHCP .

Local IP: display IP address of the meter, click icon “” to enter “System setting-IP setting”.

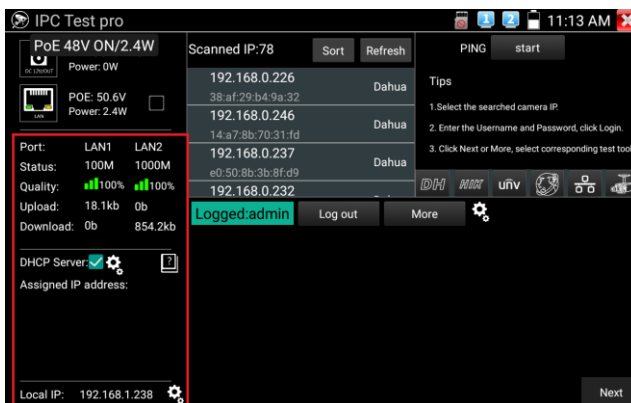

Camera information

Total number of searched IP address: Display the searched device IP address list. After entering the APP, when the network is connected, it will automatically search for the IP of the cameras in the entire network connected to the tester. Click "Sort" to sort by IP in ascending order. Click "Refresh" to search the list again.

PING test: After selecting the IP address of the camera, click "Start" to perform a ping test.

HIKVISION and Dahua camera activation

After searching for inactive cameras, click on the camera IP to pop up an activation window.

All inactive cameras will be activated in batches, and after activation, the camera IP addresses will be automatically incremented modified by default. The IP address range can be set by yourself.

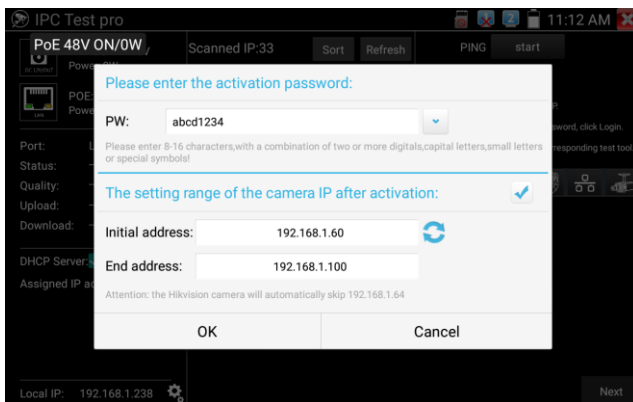

Camera image display:

- 1) Input the correct Username and Password, When there is no input box, click "Logout" to expand the input box.
- 2) Click the camera IP to display the camera image.
- 3) Double-click the image display area or click "Next" to jump to the ONVIF function.
- 4) Dahua, Hikvision, and Uniview etc camera can be tested with the corresponding camera test tool on the right side of the IP list.

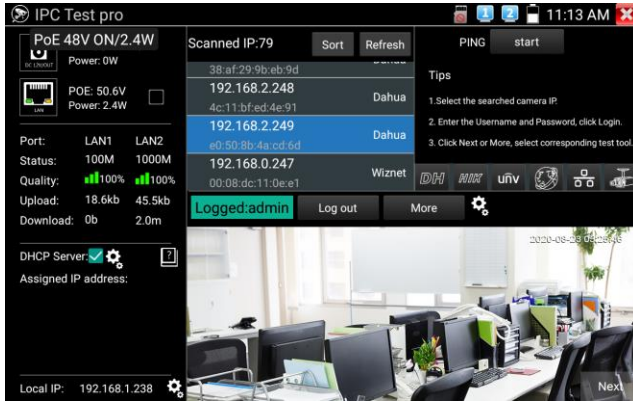

Setting

Auto login: ON/OFF

Video transmission protocol: If the video can't be displayed when input the correct camera username and password, please try to switch the video transmission protocol. Some cameras only support UDP transmission protocol.

More features

Click "more" to jump to more function interface. Click "+" icon to add other programs for quick jump.

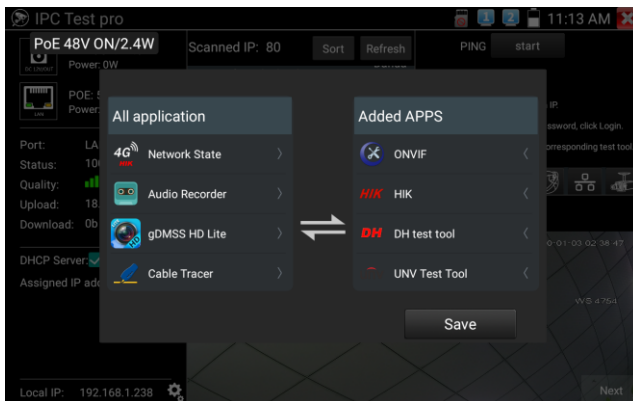

3.3.7 IP discovery

Press IP discovery  , tester auto-scan the whole network segment IP, as well as auto-modify the tester's IP to the same network segment with the scanned camera's IP.

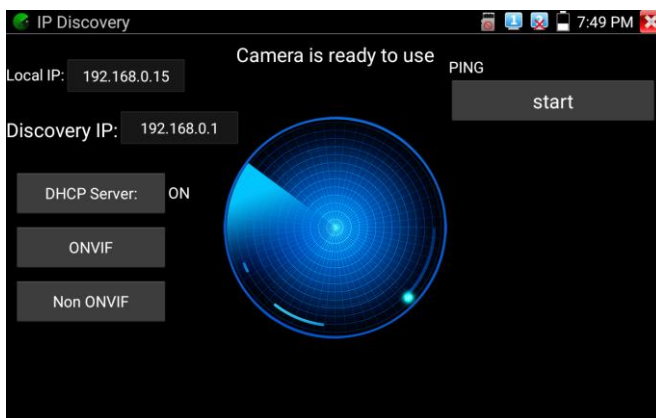

Local IP: Tester's IP address, Tester can auto-modify the tester's IP to the same network segment with the scanned camera's IP

Discovery IP: Connected tester equipment's IP address. If the camera connected to the tester directly, tester will display the camera's IP address, if tester connects to Local Area Network, it displays the current IP address.

Temp IP: After searching IP address, the modified tester's IP address will not be saved, if you do not select "Temp IP" the modified tester's IP address will auto-save after searching.

Start: PING function, Click "Start", can PING camera's IP

Rapid ONVIF: Rapid ONVIF Quick link

NON ONVIF: NON ONVIF Quick link

Applicability: Using IP discovery app, you don't need to know the first two digits of camera's IP address, it can auto-scan the whole network segment IP, and auto-modify tester's IP address, greatly improved engineering efficiency .

3.3.8 Rapid ONVIF test

Rapid ONVIF can display 4K H.265/H.264 camera image by tester mainstream, one key to activate Hikvision camera.

Press  enter Rapid ONVIF function, the meter auto scan all ONVIF cameras in different network

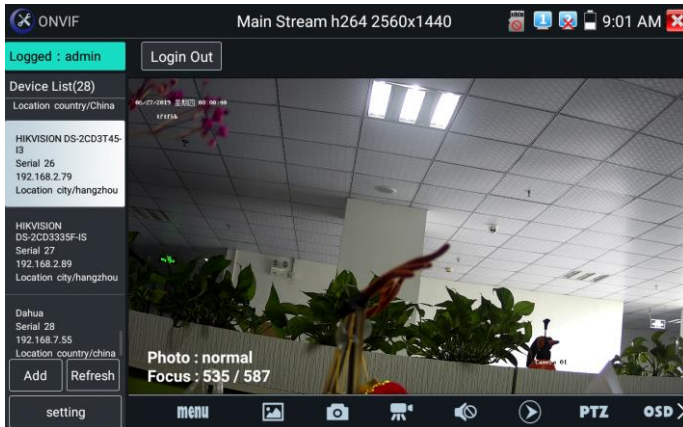

segments. It lists cameras name and IP address on the Left of screen. Tester can auto login camera and display camera image. Factory default use admin password to auto login, if you modified the password, then default use the modified password to log in.

If you select ONVIF Rapid mode, the meter automatically scan different network segments for ONVIF cameras. It lists the camera name and IP address on the Device List. Tester can auto login camera and display camera image.



Click the button "Refresh", tester will scan the ONVIF camera again. Click the newly displayed ONVIF camera on the "Device List". The tester will show the IP camera's relative information and settings.

Activate HIKVISION Camera: When connected inactivated HIKVISION Camera, tester can auto recognized, and prompt "The camera have not been activated, activated now?", click "OK" to start activate .

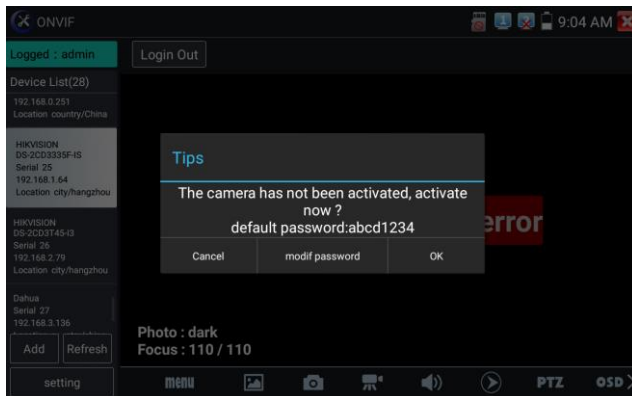

Pop-up settings menu when click the "ONVIF setting" icon in the upper left corner.



Cross network scan: After open this function, enter "Setting - IP Settings - Advanced" to add other network segments IP, Rapid ONVIF function can across network segments to scan camera's IP.

Auto Login: After open this function, tester can auto login camera and display camera image. (The login password is the same with last time, the first time using password is the default password "admin")

Video transmission protocol: UTP and TCP protocol.

View manual: Open Manual.

Restore Defaults settings: Revert "Rapid ONVIF" to default settings.

OK: Save the modified parameters.

Click "MENU" icon to open camera setting.

While in the "Live video" menu, click "Video Menu" at the top right of the image to access the following tools: Snapshot, Record, Photo, Playback, PTZ and Settings.



ONVIF PTZ control: Tap the image in the direction you want the PTZ camera to move. Tap the left side of the image to move left, right to go right, up to go up and down to go down. Compatible IP PTZ cameras will rotate accordingly. PTZ rotation direction is displayed on top left corner of the image.

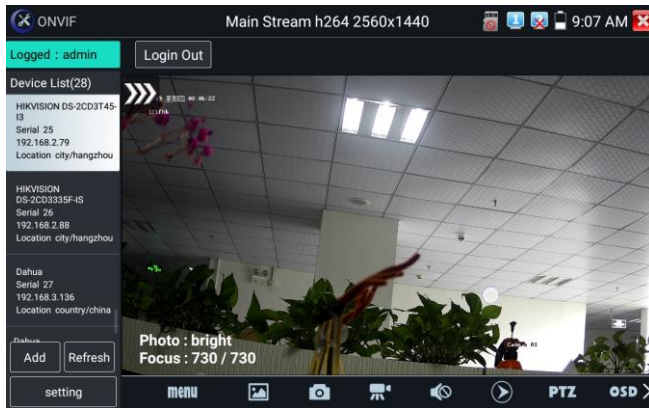

IP camera video settings: Click "Video Set" to enter the IP camera's encoder and resolution settings. Make the desired changes and click "OK" to save.

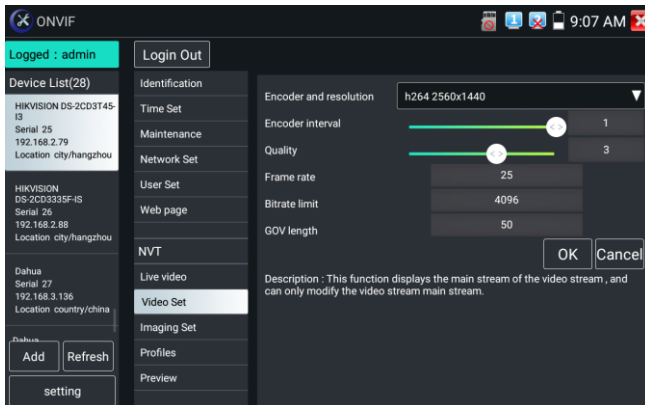
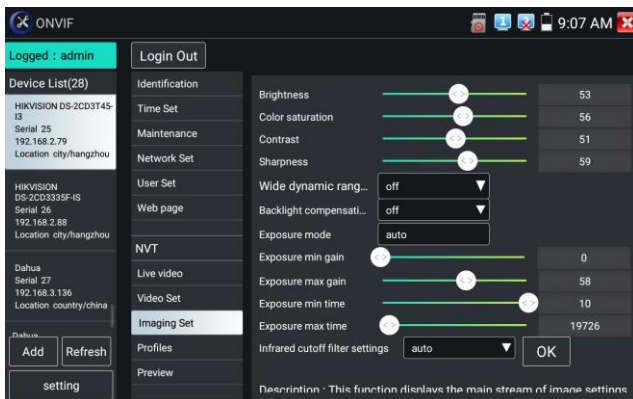

Image setting: Click "Imaging Set" to adjust image brightness, saturation, contrast, sharpness and backlight compensation mode.



Profiles: Click "profiles", can view video streaming current configuration files, as well as switch between Major stream and minor stream.

Preview pictures: Quickly preview and zoom in or out pictures, automatically and manual refresh.

Identification: Click "Identification" to view information of the camera.

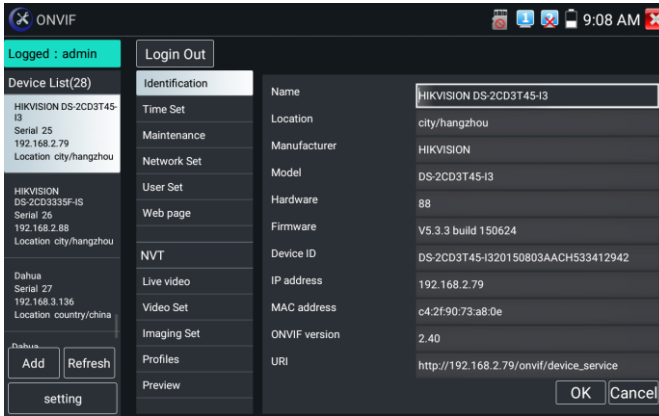

Time set: Click "Time set", Select "Manual set" to set up the time of camera.

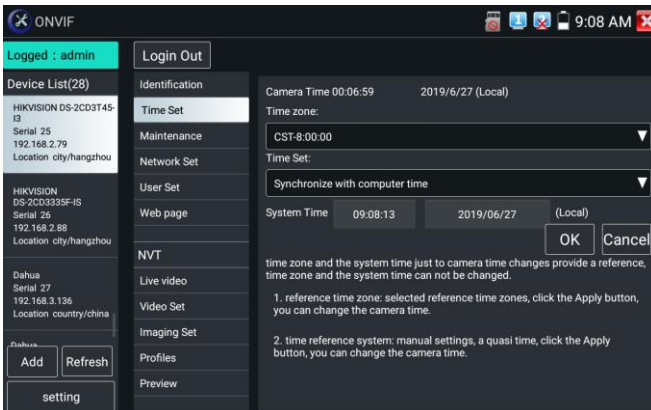

Maintenance: For camera software reset or restore to factory settings.



User Set: Modify camera user name, password etc parameters.

Network setting: Click "Network Set" to change the IP address. Some cameras cannot support change IP address, so there is no change after saving.



Zoom in image: Press the  key to enter the zoom mode. Press it again to exit zoom mode. When the image is enlarged tap left, right, up or down on the image to move the whole image on the screen



When the image is enlarged, if not operate on touch screen, it can operate by the keyboard, press the key  to zoom in, press the key  to zoom out, press upward and downward key to move image.

If it is network video input to the tester, as the tester supports resolution up to 1080p, the input image will be very clear after it is enlarged. This is greatly helpful for the installers to ensure the IP camera's video coverage and decide the IP camera's install site.

Image can only be enlarged on SD mode (The icon "ONVIF" is SD mode.)

Select relative function on the bottom Toolbar to operate, "Snapshot", "Record", "Photos", "Video playback", "Storage set", "PTZ control" etc.

Snapshot: Click bottom "snapshot" to screenshot the image and store it to SD card.

If select manual storage, appears dialog box "Input Name", user-defined the files name(by Chinese character, English letter or digit) to save in SD card, if select "Auto- storage", the tester auto stores the files after snapshot.

Record: When you click bottom the "Record" icon, video starts recording. A red recording icon appears on the screen and begins to flash and a timer appears indicating the time elapsed for the video. Click on the "Stop" icon to stop recording and save the video file to the SD card.



Playback: Click the "Playback" icon to view saved videos. Double click the video you want to play. Click to return to the last menu.

To rename or delete a photo, click and hold on the file until this screen appears:

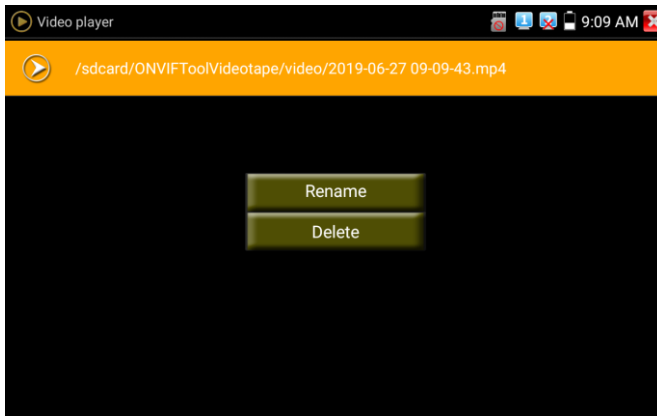

OSD Menu: Select OSD and pop up the OSD menu. include time, channel name and other optional items.

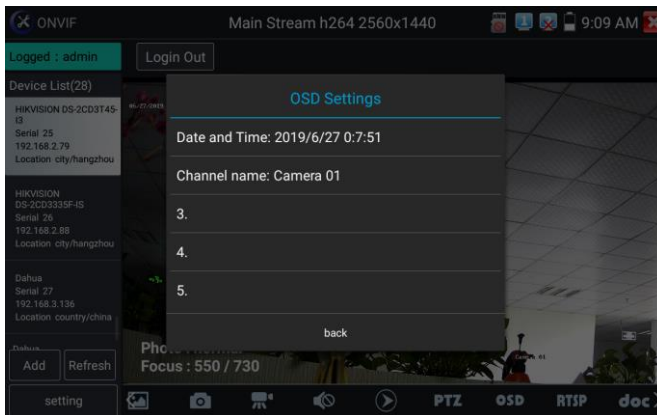

After channel selecting, you can edit the channel name, modify the display position, and switch the font size. Select "default location" in "content location" is without modification. Select "Customization" to arbitrarily adjust the channel name and display location. Click "OK" and the effects will appear. Press return key or click any area of the screen to return to the upper layer of the interface.

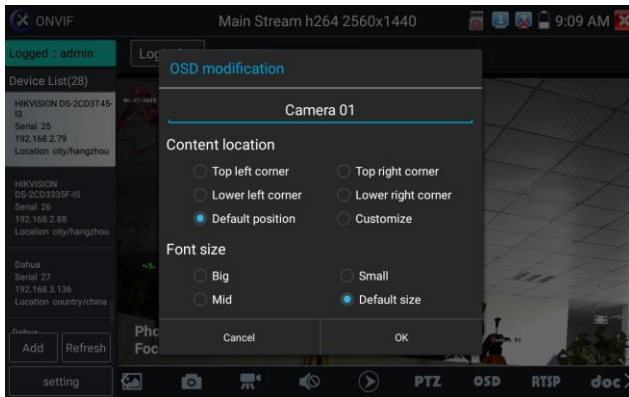

Video files can play in the Video player on the main menu.

PTZ

Set preset position: Move the camera to preset position, enter the preset number on the Bottom right corner to complete position preset.

Call the preset position: Select the preset number on the left, click "Call" to call preset.

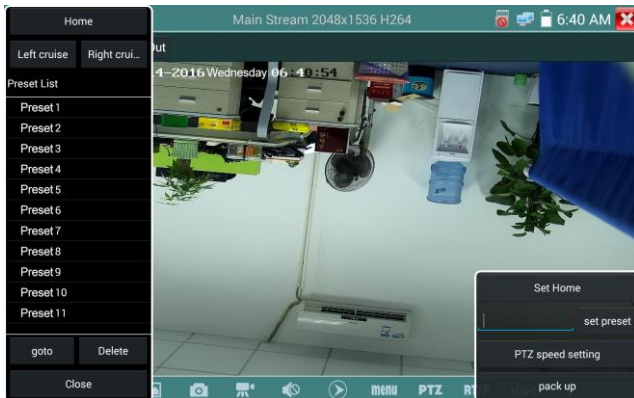

PTZ Speed set: Horizontal and Vertical Speed set.



RTSP: Get RTSP address of the current camera

Doc: Auto generate test reports document of camera, click "generate document". Click Preview to view the report document.

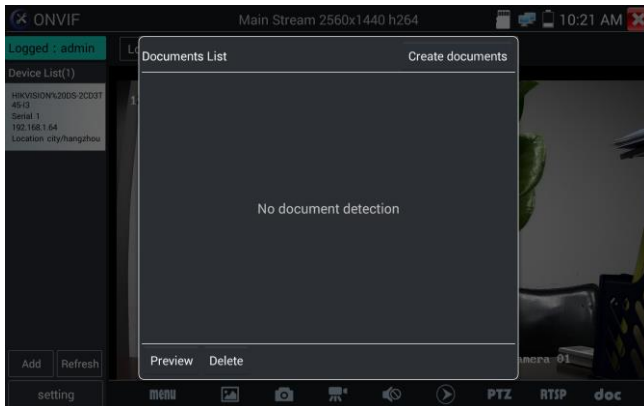

Enter the camera test information, click "Generate Document" to complete the report.



Click "Doc" menu again, you can preview the report document.

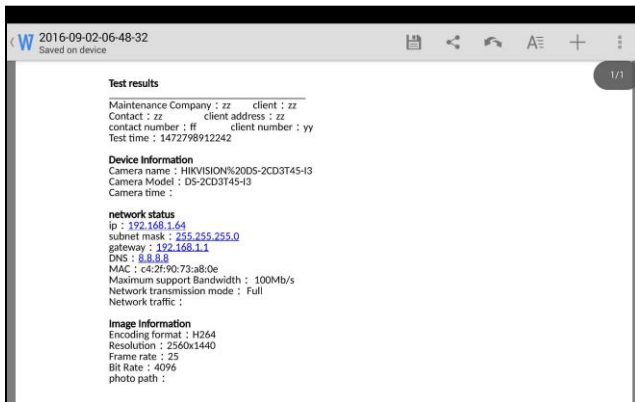

Icons description: The description of function icons on the bottom toolbar.

3.3.9 NON ONVIF

Display image from the 4K H.265 camera by mainstream

Click icon  to enter IP camera test



Note: Currently, the IPC Test App only supports some brands' specific IP cameras, these include specific models made by ACTI, AXIS, Dahua, Hikvision, Samsung, and many more. If the camera is not fully integrated, please use the ONVIF or RTSP apps.

IPC test interface



The screenshot shows the 'NON ONVIF' configuration screen of an application. The interface is dark-themed with white text. At the top, there's a title bar with the text 'NON ONVIF' and a status bar showing the time '7:59 PM'. Below the title bar, there are several configuration fields, each with a label on the left and a value in a dark box on the right. To the right of each value box is a button. The fields are: 'Local IP' with value '192.168.0.15' and an 'Edit' button; 'IP camera type' with value 'HIKVISION_DS-2CD864-E13' and a 'Manual' button; 'IPC Cameras IP' with value '192.168.0.64' and a 'search' button; 'IPC User Name' with value 'admin'; 'IPC Password' with value '.....' and a 'Show' button; 'IPC Port' with value '5198'; and 'Video streaming transp...' with value 'TCP'. At the bottom of the screen, there are four buttons: 'Enter', 'Reset', 'Restore', and 'Rate'.

Local IP: This is the tester's IP address. Click "Edit" to enter "IP setting" and change the tester's IP address settings.

IP camera type: Click on the IP Camera type to select the Manufacturer and model number of the integrated IP camera.

"Manual": Click IP camera type, list Honeywell, Kodak, Tiandy, Aipu-waton, ACTi, WoshiDA IP camera etc. If the brand has offered official original protocols, pls select camera type, input IP camera address, user name and password, click "official" to enter the camera image display interface (Currently, only support DAHUA official protocols)

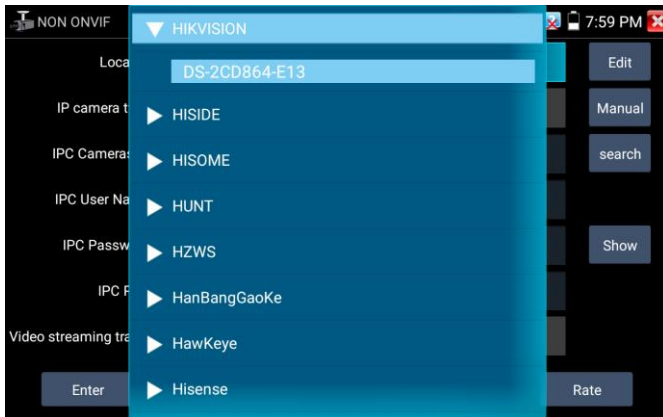

Stream code: When test camera via RTSP, you can select mainstream or sub stream to test (if camera's RTSP have not been start or without, it will tip "auto match fail, please switch to manually selecting").

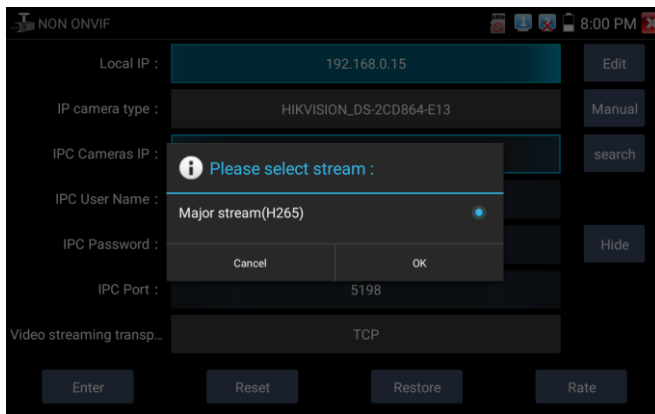

IP Camera's IP: Enter the IP camera's IP address manually or click "Search" to auto-scan for the IP camera's IP address. It is better to directly connect the IP camera to the tester so the search results will only display the camera's IP address. If the tester is connected to a PoE switch, it will find and display several IP address.

IPC User Name: Enter IP camera's user name.

IPC Password: Enter IP camera's login password.

IPC Port: When you select the IP camera type, it will default the camera's port number and doesn't need to be changed.

After all settings are completed, click "Enter" to view the live video.

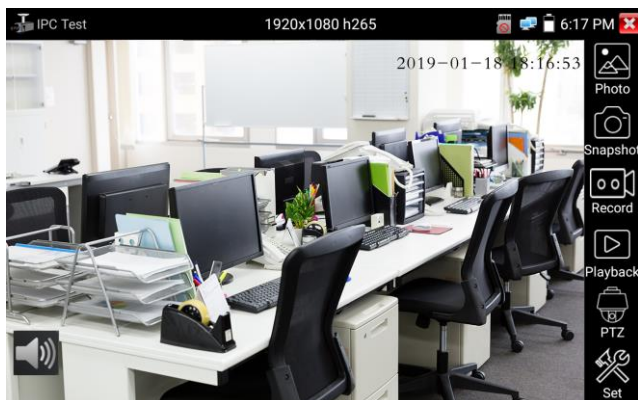

If IP address setting has error or IP camera is not connected.. The tester prompts "Network Error"

Click  to quit from image display and return to IP camera test interface.



Once you are viewing video on the IPC Test app, you will see the "Video Menu" icon on the top right. This button will give you access to Snapshot, Record, Photo, Playback, PTZ, and Set. Please refer to the ONVIF section to use these functions.

3.3.10 HDMI IN (*Optional)

HDMI in HD signal test, Tap icon "" to enter

When tester receives HDMI in image, the top tool bar shows the resolution of this image. You can select "resolution" to set resolution in the setting menu. Tap screen by twice, full image display.

Support resolution below

4K_3840×2160-30FPS/2K_2560×1440P/1920×1080p /1920×1080i /720×480p /720×576p /1280×720p/1024×768p/1280×1024p /1280×900p /1440×900p



(1) Snapshot

Click the icon "Snapshot", when the video in, to take a picture and save the current video frame in the SD card as JPEG file.

If the unit is set to the manual mode an "Input Name" pop up box will appear and you can enter a title for the snapshot. If the unit is set up to automatically set file names, this box will not pop up.

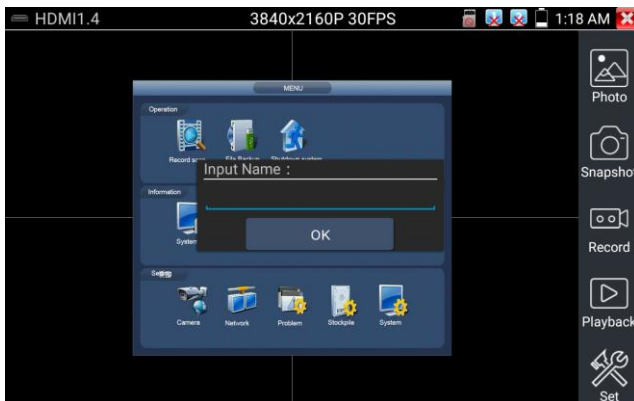

(2) Video record

When you click the "Record" icon, video starts recording. A red recording icon appears on the screen and begins to flash and a timer appears indicating the time elapsed for the video. Click on the "Record"

icon again to stop recording and save the video file to the SD card.

if select manual storage, before recording begins, appears dialog box "Input Name", user-defined the files name(by Chinese character, English letter or digit) to store in SD card, tester will hereby store the files in SD card after recording. if select "Auto-storage", tester will auto store the files in SD card after recording.



(3)Photo

Click the icon "photo" to enter, click the selected thumbnail photo to display it on the screen.

Double-tap the image you want to view to make it full screen. Double-click again the photo to return.

To rename or delete an image, click and hold on the file until this screen below appears

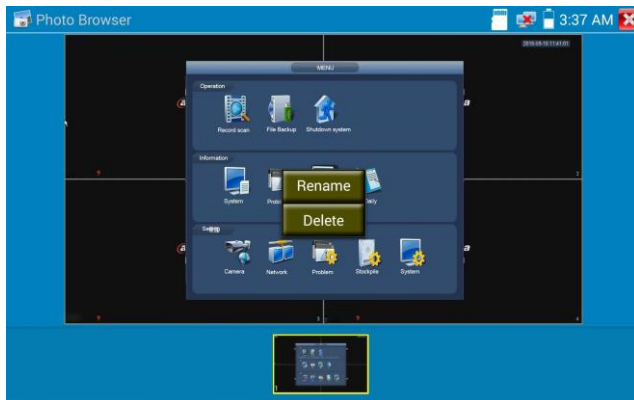

Click to close and return to PTZ controller.

(4) Recorded video playback

Click the "Playback" icon to view your recorded videos. Tap on the video file image you want to watch. To rename or delete a video, click and hold on the file until this screen appears:

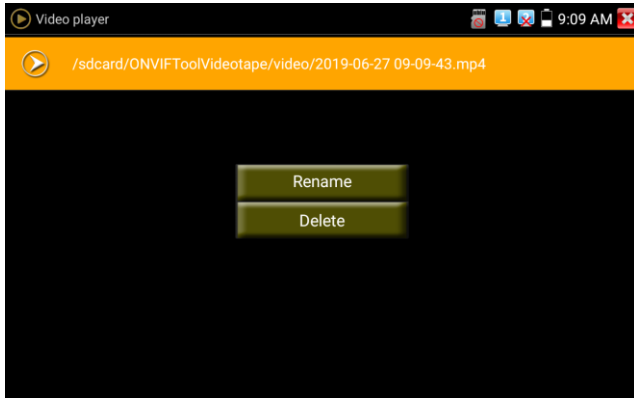

Video files also can play in the main menu "Video Player".

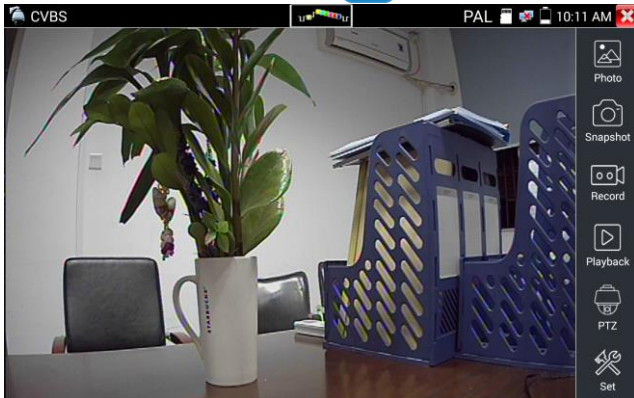

3.3.11 Analog camera test

Analog camera test and PTZ control, click icon  to enter



Display the input video image, click the top menu bar icon  to enter video level meter, (PEAK level, SYNC level, COLOR BURST measurement)

Select relative function on the right side Toolbar to operate, functions including "Photos", "Snapshot", "Record", "Playback", "PTZ", "Set".

Click , or press  to quit.

Click the screen twice quickly, can be full zoom in on the touch screen.

1) PTZ controller parameter setting

Select and click icon "PTZ", to enter PTZ setting:

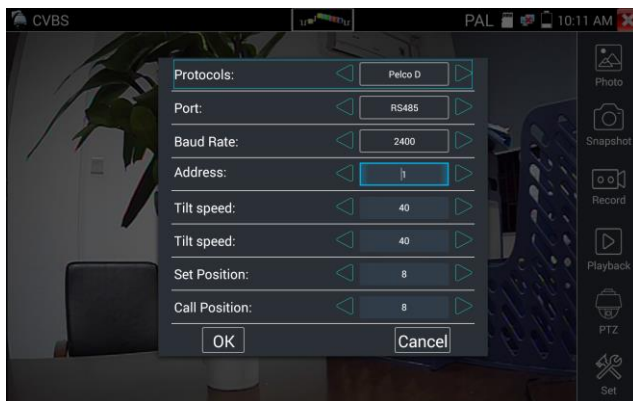

A. Protocol

Use the up and down arrow keys to move the yellow cursor to the "protocol", set corresponding Protocol and support more than thirty PTZ protocols. Such as Pelco-D, Samsung, Yaan, LiLin, CSR600, Panasonic, Sony-EVI etc.

B. Port

Click and move to "port" Select the communication port for the PTZ camera controlling (RS485)

C. Baud

Move the yellow cursor to "Baud ", Select the baud rate according to baud rate of the PTZ camera.(150/300/600/1200/2400/4800/9600/19200/57600/115200)

D. Address

Set the ID according the ID of PTZ camera (0~254), the setting address data must be consistent the speed dome address.

E. Pan speed: Set the pan speed of PTZ camera (0~63)

F. Tilt speed: Set the tilt speed of PTZ camera (0~63)

G. Set preset position (Set PS)

Click and select "Set PS", set and save preset position number(1~128).

H. Call the preset position (Go PS)

Click and select "Set PS", set and save preset position number (1~128), click "sure" to save,

Call some special preset number, can call the dome camera menu



Check and set the protocols, address, interface and baud, all must be consistent with the dome camera, then the IPC tester can test. After setting the parameter, the tester can control the PTZ and lens

To control PTZ by screen touch:

Tap left, right, upward and downward on the touch screen to control the PTZ rotation direction. By two fingers move outward and inward on the touch screen to zoom in and out the PTZ.

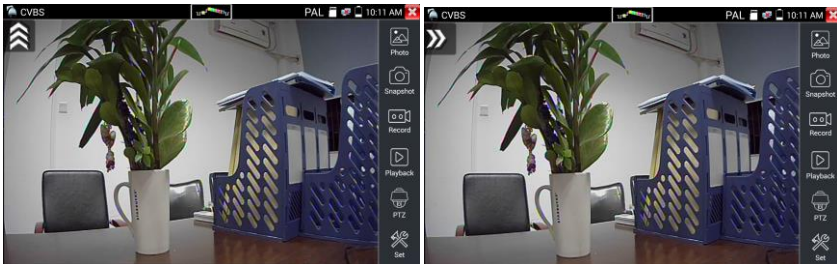

PTZ Control:

Press the key control the PTZ direction of rotation

Press the key or , switch on or turn off the aperture.

Press the key or , adjust the focus manually

Press the key or , manually adjust the zoom

2) Video and storage setting

Click icon "set", to enter and set analog video image brightness, contrast, color saturation, as well as the file storage way after snapshot and recording, support auto-storage and manual storage.

When select manual storage, user can name and store the files.

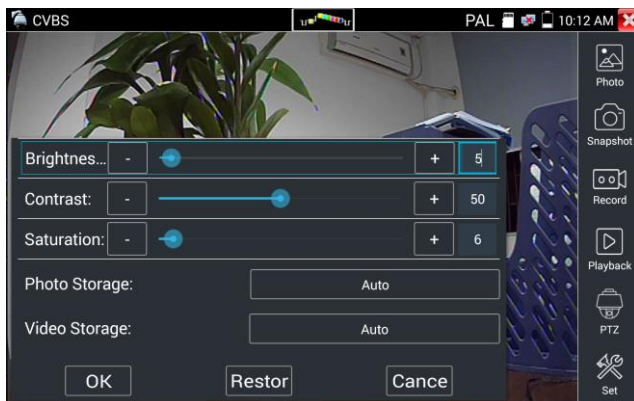

3) 4 x zoom image display and Video out

When image input, press  to enter "zoom", press it again to quit.

Using the touch screen to control PTZ camera movement:

Tap left, right, upward or downward on the video image to move the PTZ camera in a desired direction.

Stretch two fingers outward or inward on the touch screen to zoom the image in or out.

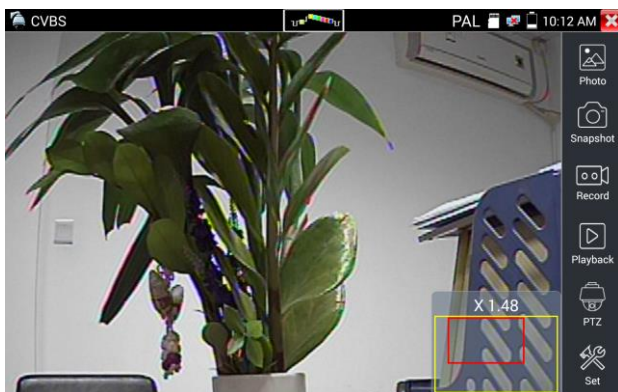

If not use touch screen to operate, press the key  to zoom out , press the key  to zoom in, press upward and downward key to move the image.



For analog video input, as the resolution is 720*480, it is normal that the zoom in image is not

clear. But for network digital video input, as it supports resolution up to 1280*960, the zoom in image is still very clear. This is very helpful for IP camera installation.

4) Snapshot

Click the icon "Snapshot ", when the video in, to take a picture and save the current video frame in the SD card as JPEG file.

If the unit is set to the manual mode an "Input Name" pop up box will appear and you can enter a title for the snapshot. If the unit is set up to automatically set file names, this box will not pop up.

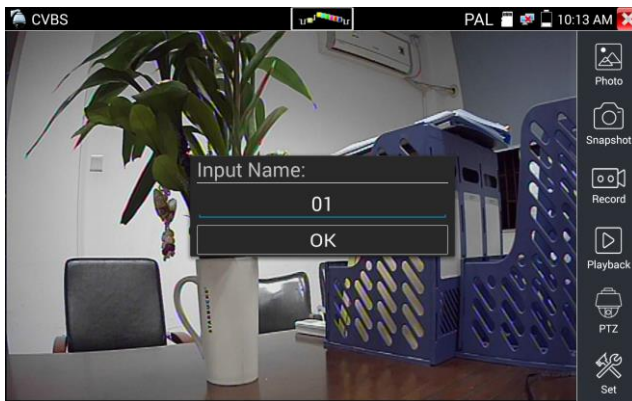

5) Video record

When you click the "Record" icon, video starts recording. A red recording icon appears on the screen and begins to flash and a timer appears indicating the time elapsed for the video. Click on the "Record" icon again to stop recording and save the video file to the SD card.

if select manual storage, before recording begins, appears dialog box "Input Name", user-defined the files name(by Chinese character, English letter, or digit) to store in SD card, tester will hereby store the files in SD card after recording. if select "Auto-storage", tester will auto store the files in SD card after recording.

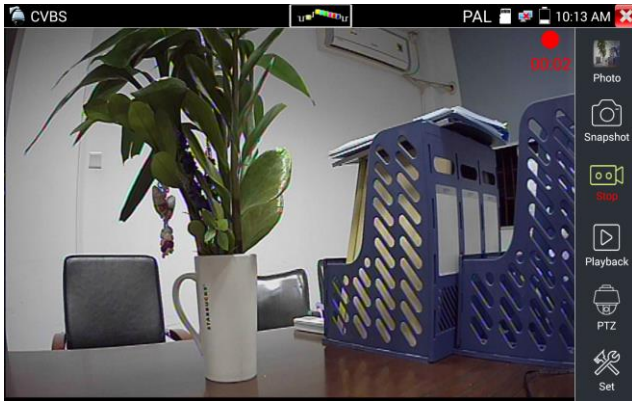

(6)Photo

Click the icon "photo" to enter, click the selected thumbnail photo to display it on the screen.

Double-tap the image you want to view to make it full screen. Double-click again the photo to return.

To rename or delete an image, click and hold on the file until this screen below appears.



Click to close and return to PTZ controller.

(7) Recorded video playback

Click the "Playback" icon to view your recorded videos. Tap on the video file image you want to watch.

To rename or delete a video, click and hold on the file until this screen appears:

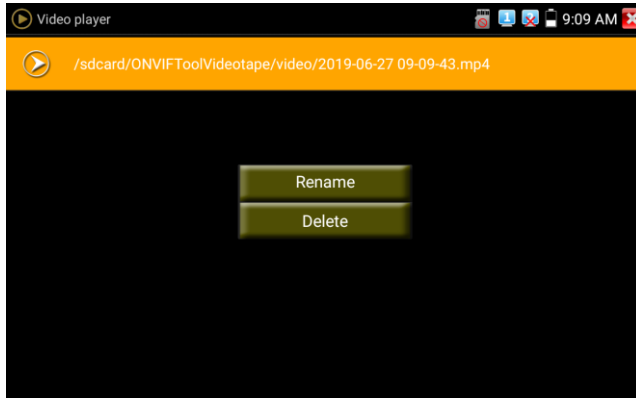

Video files also can play in the main menu "Video Player".

(8) Video level meter (*optional)

Click the icon  to enter, the IP camera tester has adopted hardware high-speed sampling and processing technology, can perform both NTSC and PAL video amplitude signal measurements for PEAK to PEAK, SYNC levels and COLOR BURST chroma level. When an analog signal is fed into the meter, the tester displays the measurements on the bottom left corner of the screen

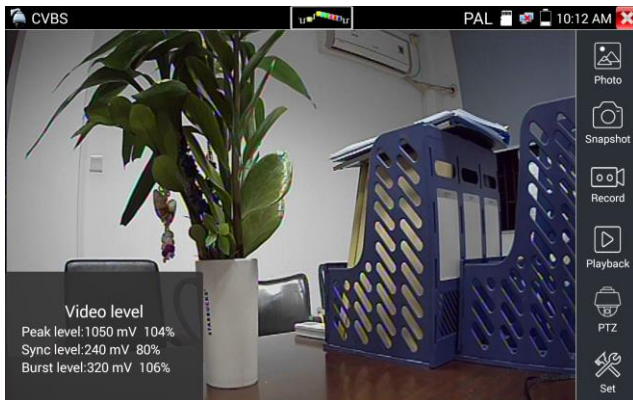

While in PAL format, the unit will be mV, While in NTSC format, it will be IRE.

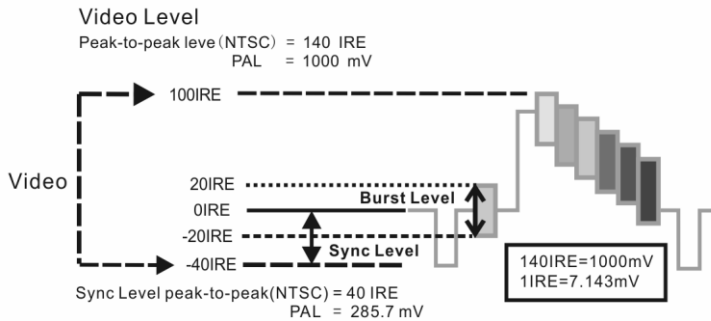

NTSC	Video signal level	140±15IRE
	Chroma level(COLOR BURST)	40±5IRE
	SYNC signal level	40±5IRE
PAL	Video signal level	1000±200mV
	Chroma level(COLOR BURST)	300±35mV
	SYNC signal level	300±35mV

Video signal PEAK to PEAK level:

For NTSC format, the video signal level is 140±15IRE

For PAL format, the video signal level is 1000±200mV

If the level is too low, it will cause the image to lose quality and limit the distance it will travel over cable. If the level is too high, it will distort the image.

SYNC level: Tests the amplitude of the video sync pulse to verify if the video level is correct.

For NTSC format, the SYNC level is 40 ± 5IRE

For PAL format, the SYNC level is 300 ± 35mV

If the level is too low, it will cause the image to not frame out properly. If the level is too high, it will lead to a poor quality image.

COLOR BURST level: Testing the color burst level will determine if the burst signal is sufficient to trigger the displays color producing circuit. Burst will diminish in amplitude over longer cable runs and can get fall below the threshold for the video display to show a color image.

For NTSC format, the Chroma standard level is 40 IRE

For PAL format, the Chroma standard level is 280mV

If the Chroma level is too low, the color will not be as deep, and some details of the image will become lighter. If the Chroma level is too high, there will be distortions on the image. If the coaxial cable is too long, it will reduce the chroma level.

Image loop test: Test video optical transmitter and receiver and video cable, connect one end to the tester "VIDEO OUT" port, and the other end connected to "VIDEO IN" port, the signal send via "VIDEO OUT" port, and received via "VIDEO IN" port, If the testing is ok, the tester displays several gradually dwindling photos on the desktop.

3.3.12 Color-bar generator (TV OUT)

Click  to enter, the tester sends the color bars from the "Video out" port, Click the icon "PAL", select "PAL/NTSC" output formats.

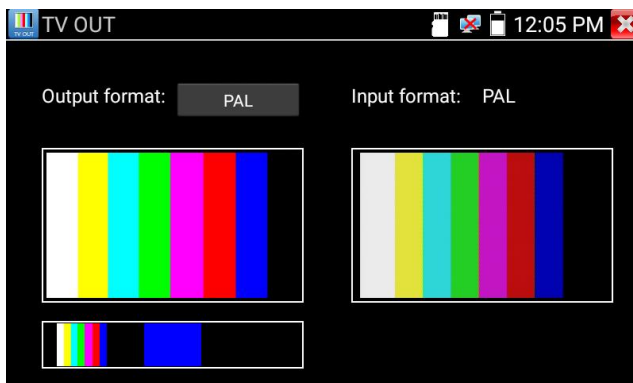

Click the selected color-bars, testing image or single bar (red, green, blue, white or black). Double click to full display on the screen and output, click  to return main menu.

Application

BNC loop test: Tester can send and receive color bar generator through the tester's "video out and video in" port, it is for testing transmission channels, such as video Optical, video cables etc. The tester "VIDEO OUT" port to connect optical terminal's sending port, and "VIDEO IN" port to optical terminal's connect its receiving port.

A. When maintaining the dome camera, the tester sends out the color bar by its BNC output to the monitor at the monitoring center. If the monitor receive the color bar, it means the video transmit channel works normally. Meanwhile on the basis of the received color bar, the monitoring center can judge if transmission has loss or interference.

B. The tester sends out the pure color bar (such as white and black color), to test the monitor whether has bright or black dots

C. The tester sends out video signal image to test if the image received by the monitor has excursion.

3.3.13 AutoHD (*Optional)

Auto-recognize the resolution and Auto-display the image of the connected camera. Support coaxial PT Z control and call OSD menu, support up to 8MP TVI/CVI/AHD and CVBS cameras.



3.3.14 HD Coaxial & Analog level test (*Optional)

Through hardware high-speed sampling and processing technology, accurately measure video peak level, sync level and burst level. It is used for level measurement of HD coaxial cameras, judge whether the working image of the camera and the image after attenuation by BNC cable transmission are normal, quickly detect and eliminate faults.

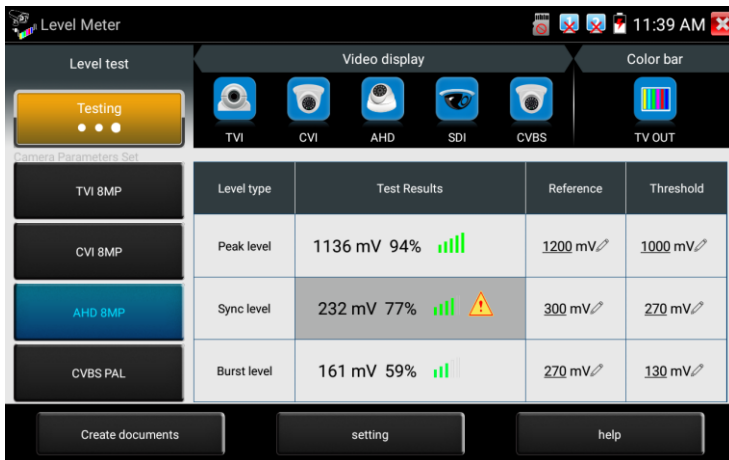

Image display: Select the camera type, no need to select the resolution, click the camera icon, can browse the camera image directly.

Level Meter Test: Need to select the camera type and resolution, click "test" to test the level

Color bar generation: Click "CVBS", quickly enter color bar generation app

Test Result: The percentage and signal grid of the level value. compared with the reference value.

When the value is lower than the threshold, the background color will be grayed and appear the warning icon. Different camera and cable lengths, different level value.

Reference value: The normal value at this resolution, it is used to reference and compare test results, click "value" to modify.

Threshold: Critical value at this resolution. Lower this value, will appear image noise on the screen, click "value" to modify.

Reset: Click "Reset" to reset the reference value and threshold.

Create documents: The testing report can save customer information, level meter test information, camera information and Instrument information.

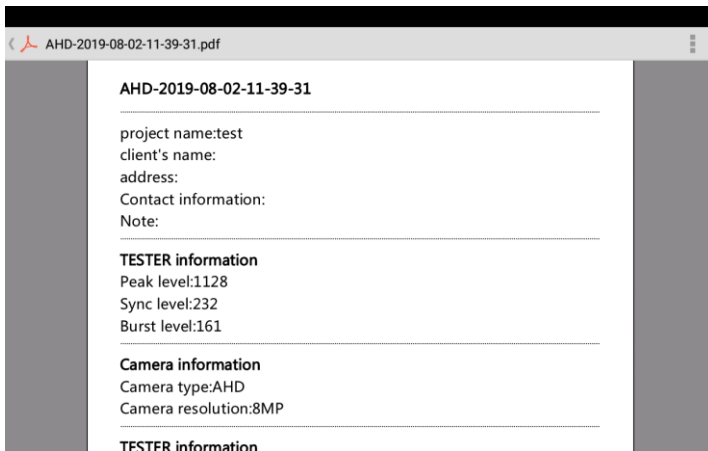
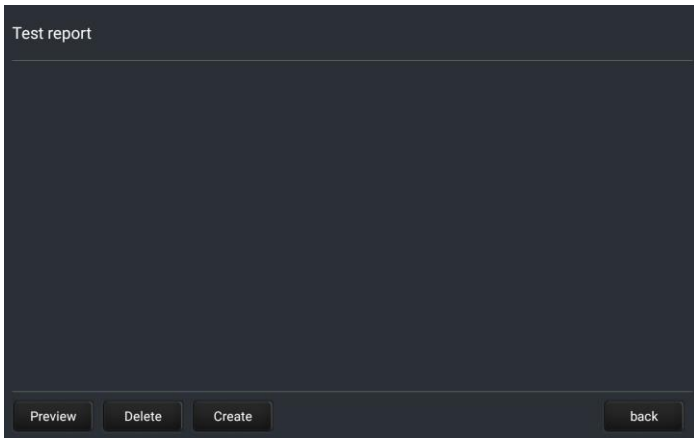

3.3.15 SDI Camera Test (*Optional)

SDI camera test, Dome camera test and PTZ control, click icon



to enter.



When tester receives SDI camera image, it will display the image data.

Double-taps on the screen to make the image displayed full screen.

The tester supports resolution as follows:

1280x720P 25Hz, 1280x720P 30Hz, 1280x720P 50Hz, 1280x720P 60Hz, 1920x1080P 25Hz

1920x1080P 30Hz, 1920x1080I 50Hz, 1920x1080I 60Hz, EX-SDI: 2560x1440P /25/30FPS,

3840x2160 20/30FPS.

IPC tester's HDMI output port can be use as SDI to HDMI converter, output HD SDI image to HD TV monitor.

Select relative function on the right side Toolbar to operate, "Snapshot", "Record", "Photos",

"Video playback", "PTZ control", "Video Brightness and Storage set", the operation is the same to the video monitor function, please refer to the relevant instructions "3.3.1" in the manual.

Click  or press  to quit.

3.3.16 CVI camera test (*Optional)

HD CVI camera, CVI dome camera test and PTZ control, click icon  to enter

When HD CVI signal input, the tester will display the image resolution on the top bar. Double-taps on the screen to make the image displayed full screen.

The tester supports resolution as follows:

1280x720P 25FPS / 1280x720P 30FPS / 1280x720P 50FPS / 1280x720P 60FPS / 1920x1080P 25FPS /
1920x1080P 30FPS/2560x1440P 25FPS/2560x1440P 30FPS/ 2592x1944P 20FPS / 2960x1920P
20FPS / 3840 x 2160P 12.5/15 FPS

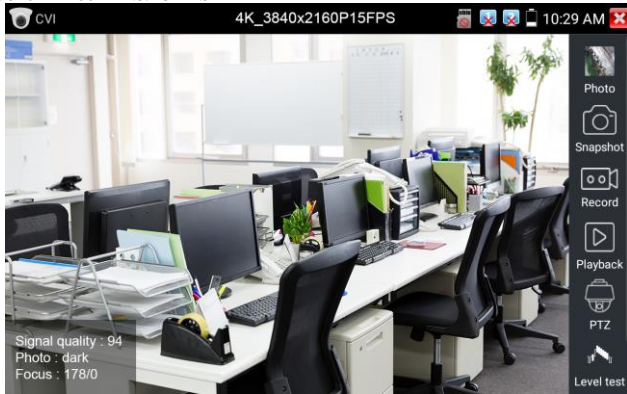

(1) PTZ control

1.1 Coaxial PTZ control

Click the icon "PTZ" on the right toolbar to do the corresponding setting.

"Port": select coaxial control

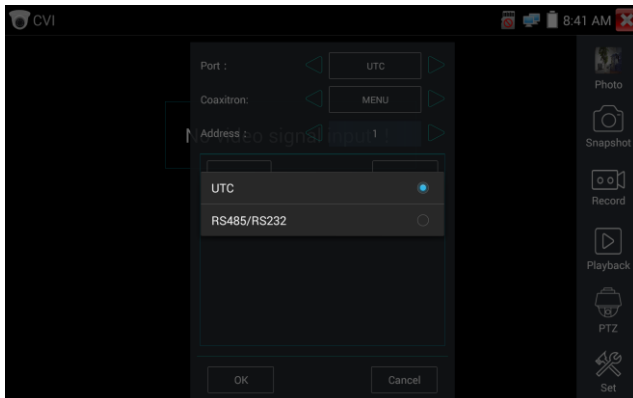

Enter PTZ address to perform parameters setting

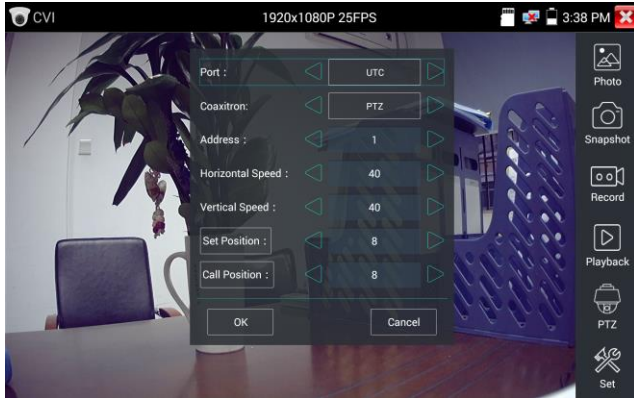

Operation instructions, please refer to "3.3.1 PTZ (1) Video monitor test"





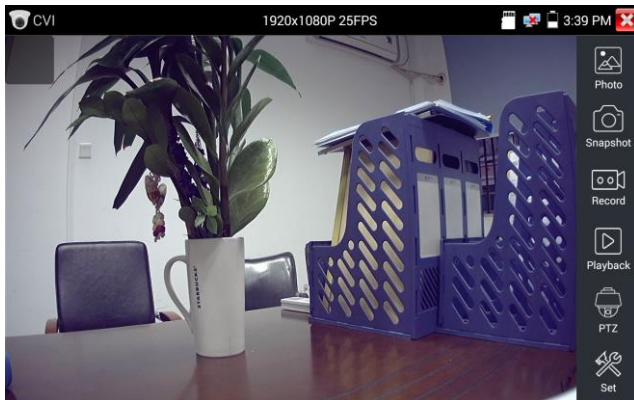







The PTZ address in the tester must be consistent with the dome camera or decoder, then the IPC tester can test. After setting the parameter, the tester can control the PTZ and lens.



To control PTZ by screen touch:

Tap left, right, upward and downward on the touch screen to control the PTZ rotation direction, PTZ cameras will rotate accordingly. By two fingers move outward and inward on the touch screen to zoom in and out the PTZ.

To control PTZ by key buttons

- ◆ Press arrow keys to control     to control the PTZ direction of rotation
- ◆ Press the key   to switch on or turn off the aperture.
- ◆ Press the key   to adjust the focus manually.
- ◆ Press the key   to manually adjust the zoom.

Set preset position

Setup preset position, move the PTZ camera to the preset position, the Tap it and input preset position number. Tap "Set position" to complete set preset position.

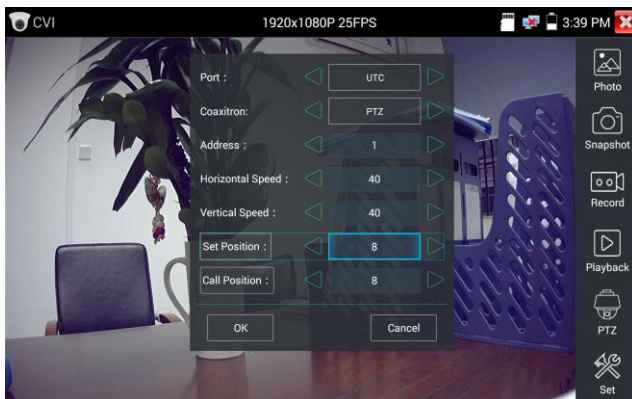

Call preset position

Tap the preset position:

Tap the preset position area, input preset position number. Tap "call position" to complete call preset position.



1.2 RS485 control

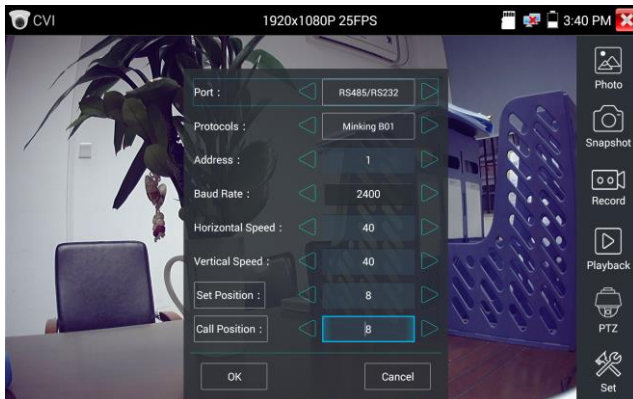

(1)Operation instructions, please refer to "3.3.1 PTZ (1) PTZ control parameters setting".

(2)Coaxial camera menu setting

Tap icon "UTC", select "menu setting" to enter the dome camera menu.

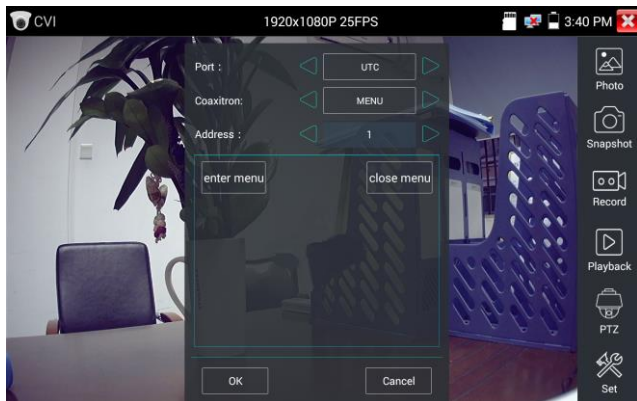

Input calling dome camera menu address code, after finishing the parameter settings, you can press the

key  or click the icon  to call the dome camera menu.

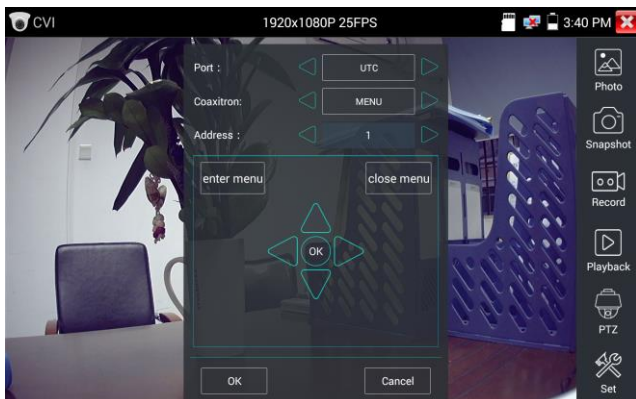

Press arrow keys     to set



(3) Snapshot, record, photo viewer and video play back, please refer to "3.3.1 PTZ (1) Video monitor test".

Tap "close menu" or press the key "  " to close camera menu.

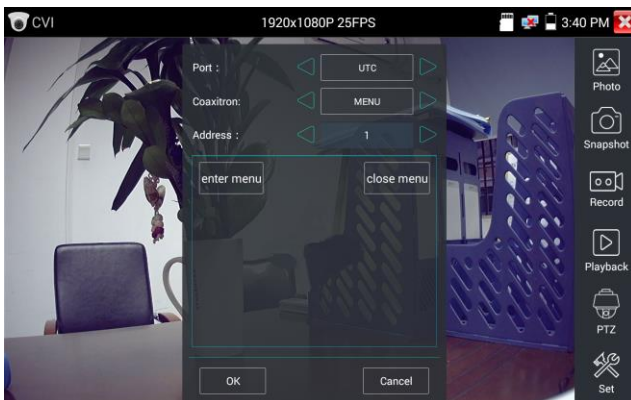

(4) Save setting

Click icon "Set" on the right toolbar to enter storage setting.

Support auto-storage and manual storage.

When select manual storage, user can name and store the files.

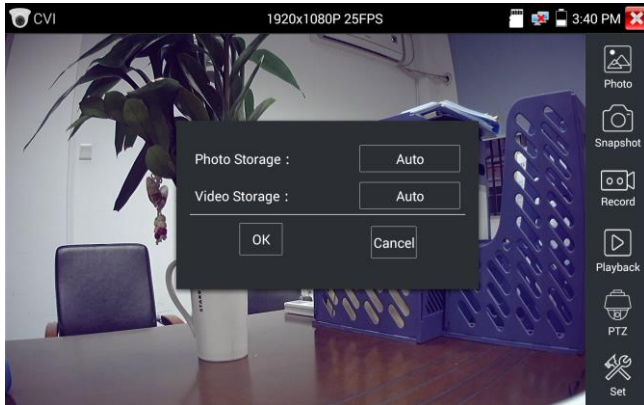

3.3.17 TVI camera test (*Optional)

HD TVI camera, TVI dome camera test and PTZ control, Click icon  to enter

The tester supports resolution as follows:

1280x720P 25FPS / 1280x720P30FPS / 1280x720P 50FPS / 1280x720P 60FPS

1920x1080P 25FPS / 1920x1080P 30FPS / 1920x1080P 50FPS / 1920x1080P 60FPS //2048x1536P

18FPS/2048x1536P 25FPS/2048x1536P 30FPS /2560x1440P 15FPS/2560x1440P 25 FPS/2560x1440P

30FPS/2688x1520P 15FPS/2592x1944P 12.5FPS/2592x1944P 20FPS/3840 x 2160P 12.5/15 FPS

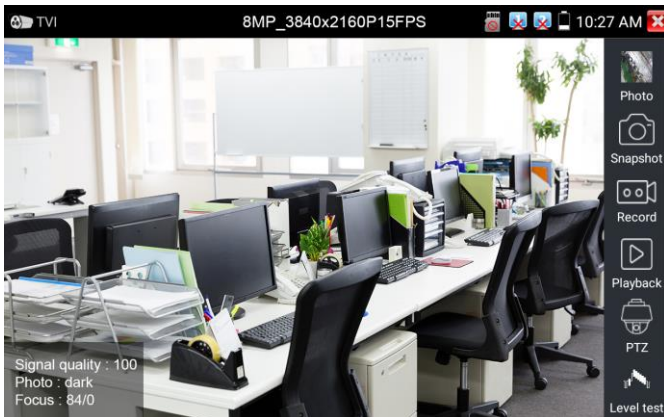

Coaxial camera menu settings

Tap icon "UTC", select "menu setting" to enter the dome camera menu.

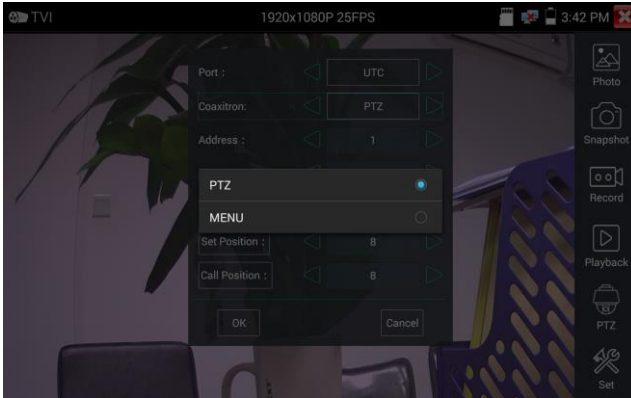

Input calling dome camera menu address code, after finishing the parameter settings, you can press the key **ENTER** or click the icon  to call the dome camera menu.

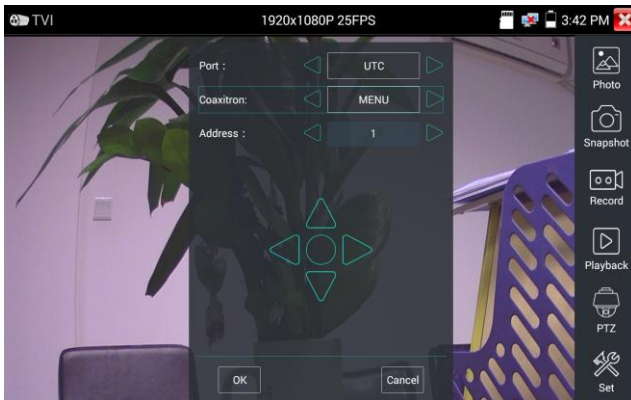

More operation instructions (such as PTZ control, coaxial camera menu setting, snapshot, recording and playback etc), please refer to "3.3.6 CVI camera test".

3.3.18 AHD camera test (*Optional)

AHD camera, AHD dome camera test and PTZ control, Click icon  to enter

The tester supports resolution as follows:

1280x720P 25,30FPS / 1920x1080P 25FPS / 1920x1080P 30FPS/2048x1536P 18,25FPS/2048x1536P 30FPS /2560x1440P 15 FPS/2560x1440P 25,30 FPS/2592x1944P 12.5,20FPS/3840 x 2160P 15FPS

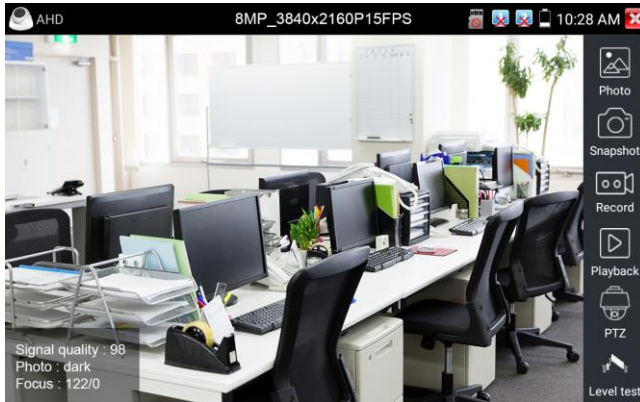

(1) Coaxial PTZ control

UTC control: select "PTZ control or PTZ control-2"(AHD camera has two different order, if select "PTZ" cannot control, please go "PTZ-2")

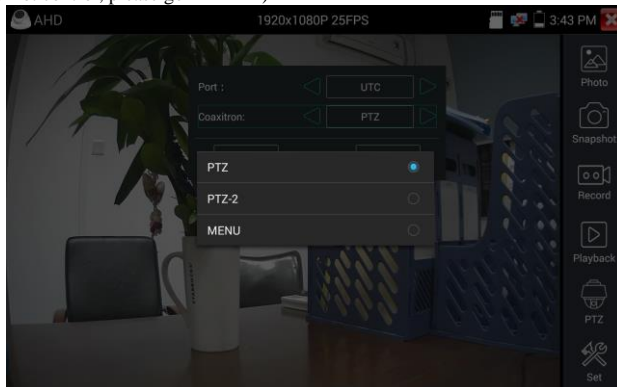

If to coaxial PTZ control the AHD camera, no parameters setting is needed.

More operation instructions please refer to "3.3.6 CVI camera test"

3.3.19 NET TOOL PRO

NET TOOL PRO-Cable Test, Wireless Tool, Link Tool, Full Duplex Detection, PING, IP Scan, DHCP Server, PPPOE, OUI Search, Socket Tool, DNS, LLLDP.

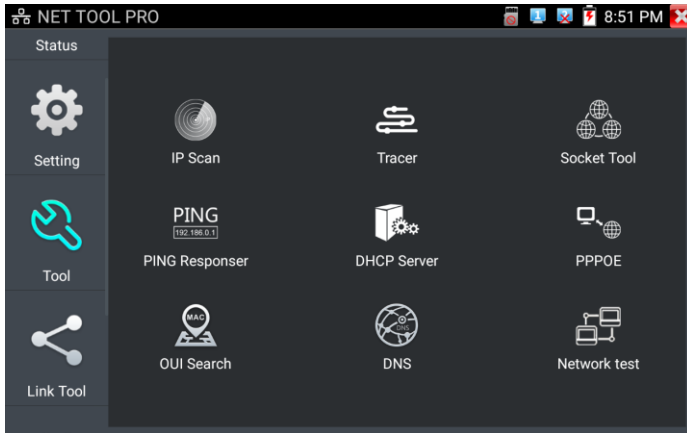

(1) IP address scan

Connect the cable to the LAN port. Set your IP address search range by changing the Start and End IP addresses. Click the "Start" button to scan the IP address range. You can also input an IP address in the Port Number Scan to scan for open ports.

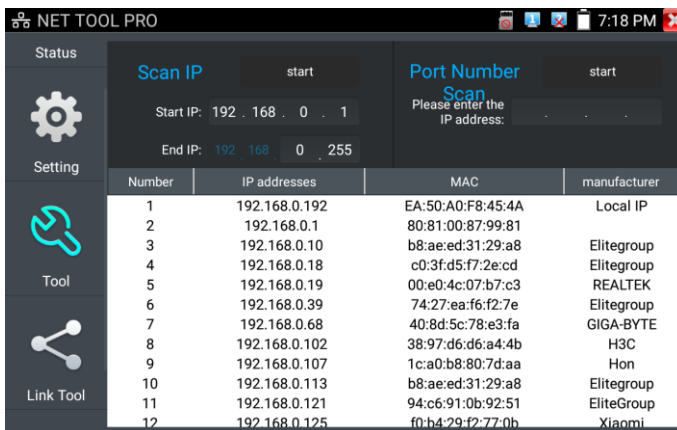

(2) PING Test

PING is the most conventional network debugging tool, it is used for testing if the connected IP camera or other network equipment's Ethernet port is working normally and the IP address is correct.

Connect a network cable to the LAN port and click the  icon to open the PING tool. You can set your LOCAL (native) IP address, Remote IP address (e.g. IP camera), Packet count, Packet Size, Packet time and Timeout. Press "Start" to start ping. If the IP camera or network device is not configured properly or not plugged in, it will say "Destination host unreachable" or "have 100% packet loss". If the tester connects to the device, the send and receive packets will have a 0% packet loss.

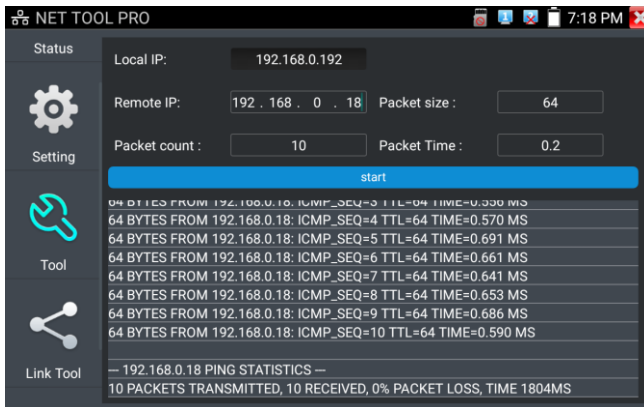

Application: PING testing is the most conventional network debugging tools. It is used for testing if the connected IP camera or other network equipment's Ethernet port is working normally and the IP address is correct.

It's normal that the first data packet will be lost when test start.

(3) Network test (Ethernet bandwidth test)

To use the Network tester, you will need two IP testers. One is used as a Server and the other as a Client.

Both devices must be on the same network segment in order to communicate. Click the  icon to open the Network Tester app.



When test, need a tester or a computer installed Network Test Software as the Server, the other tester sends packet test. The two testers must be in the same network segment.

a). Start the server: Click "Start Server" button to use the tester as a Server. It will display its IP address at the top of the screen.



b). Start send packet test: Using the other IP tester, type in the Server's IP address at the top right corner of the screen. This app is used to send packets for network speed testing. Click the "Start" button to send the packets and start testing.

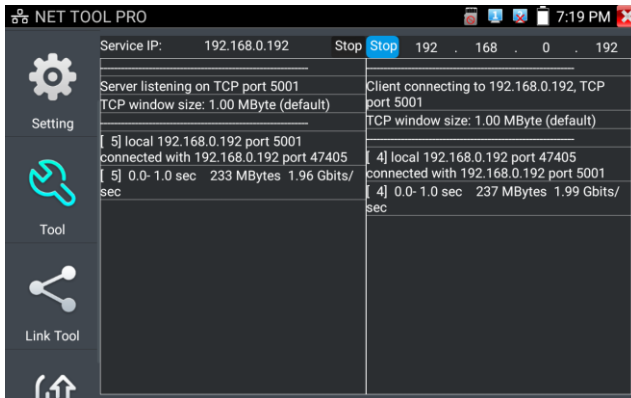

Network bandwidth testing can also be tested with a computer using compatible network bandwidth testing software. Install network bandwidth testing software on a computer, as a test Client or Server, to do the mutual testing with the tester. If use computer as the server, the computer IP address is :192.168.0.39

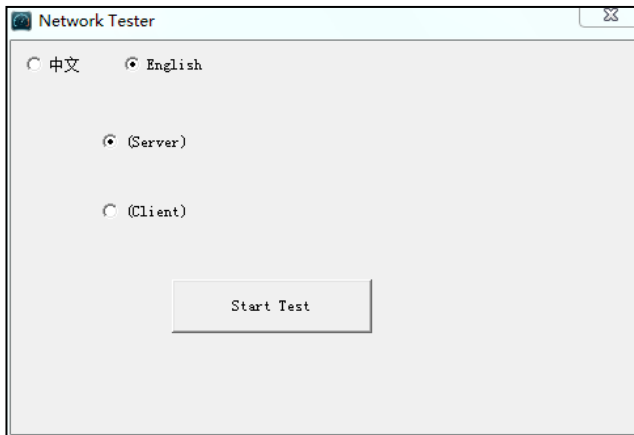

Tester as Client, tester's IP address is:192.168.0.238. The Server and the Client are at the same network segment, but with different IP address. Input Server's IP address 192.168.0.39 in the tester and click "Start" to test network bandwidth.

Or use tester as a Server, computer as test Client (select Client, input tester's IP address to test)

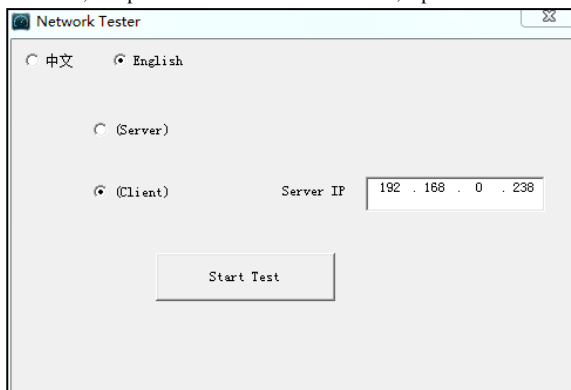

When use tester as Server, shows results:



(4) Port Flashing



Connect a network cable to the meter's "LAN" port, click the icon to open the Port Flashing app.

Click "Start". The IP tester sends a unique signal to make the connected LAN port of the switch flash.

If the tester and PoE switch are connected well, the LAN port of POE switch flash at special frequency,

If not, no any changes on the LAN port

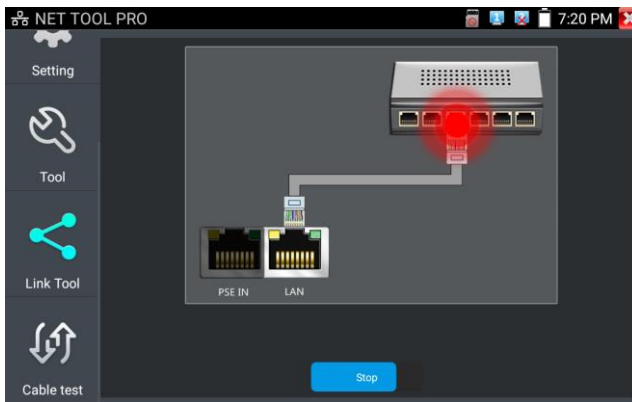

Application:

The tester will send special signals to make the connected LAN port flicker at special frequency, which will enable the installers to easily and quickly find the connected Ethernet cable. This function can prevent mistakenly insertion or disconnection non-corresponding cable to artificially interrupt network connection.

(5) DHCP server

Click on the DHCP icon to open the DHCP server app. Select the "Start" check box at the top and make any desired changes to the network settings. Click "Save" to start assigning dynamic IP addresses for IP cameras and other networked devices. Click the "Refresh" button to check your Client list.

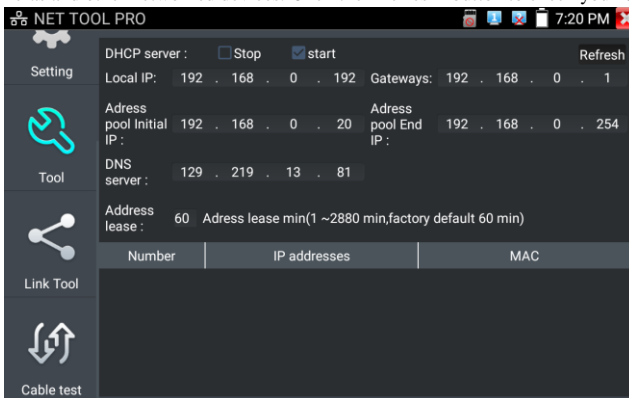

(6) Trace route

It is used to determine path of the IP packet access target.

Note: Trace route testing results only for reference, for accurate test route tracking, Please use professional Ethernet tester.

Click  to enter trace route

Input tracking IP address or domain name in the Remote Host IP. Set maximum hop count, normally default is 30

Click "start" to trace the goal address

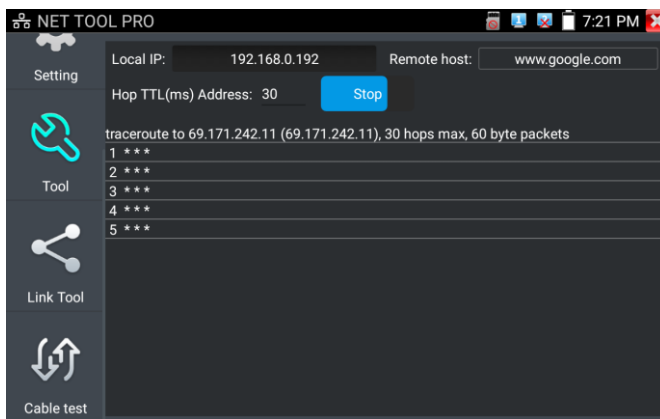

(7) Link monitor

Click the  icon to open the Link Monitor app. This app is used to see if an IP address is occupied by other network devices. This will avoid new address conflicts

Click "Add" and enter the desired IP address. To test different network segments, click the "Settings" icon on the main menu and go to IP Settings and make the desired changes. Once the desired IP addresses are added to the Link Monitor list, click "Start". If the IP address status shows a check mark the IP address is occupied. If the IP address status shows an X the IP address is available. Click "Stop" to stop the testing

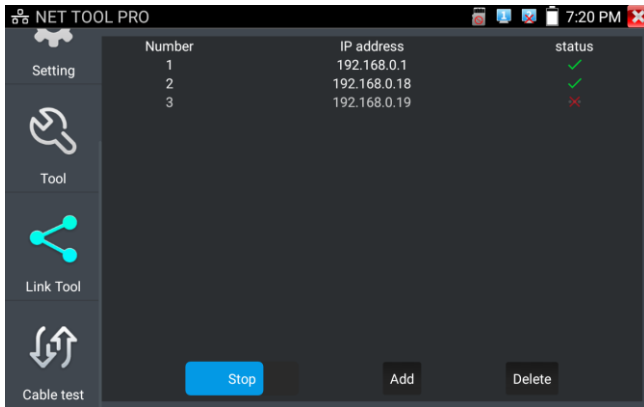

Application:

Add an IP camera or other network device to the current network group, the new IP address must not be occupied, otherwise it will cause IP conflicts and stop the equipment normal working. Link monitor can check if the new setting IP address is occupied.

3.3.20 PoE power / DC12V 3A and DC 5V 2A USB power output

When the tester is turned on, the DC 12V and DC 5V power output functions are automatically turned on. If the IP tester is turned off, the DC 5V USB can still be used to power an external USB device.

To use the PoE Power Output function, click on the icon  and change the switch "ON" or "OFF".

The IP camera needs to be connected to the LAN port before you turn PoE Power on. If the IP camera Supports PoE, the PoE power is delivered via pins 1, 2, 3, and 6 on the LAN port. The IP tester will display "48V ON" at the top of the screen when the POE power is still on.



**Note:**

1. Don't input power into the "DC12/3A OUTPUT" port.
2. Don't output this DC12V/3A power to the DC12V/IN port of the IP camera tester to avoid destroy
3. The IPC tester power output is close to 3A, if the IP camera's power is over 3A, the tester will auto enter protection mode. Disconnect all the connections of the tester and then connect the tester with power adaptor to resume the tester.
4. Before turning on the PoE power output, please make sure the IP camera supports PoE power. Otherwise it may damage the IP camera.
5. Make sure you plug in your IP camera to the LAN port prior to turning on PoE power
6. Make sure the tester is full charged or more than 80% charged, otherwise the tester will shows "low power", "not able to supply power".

3.3.21 DC 24V 2A power output

The top and the bottom of the "DC24V ON/0W "is power output interface

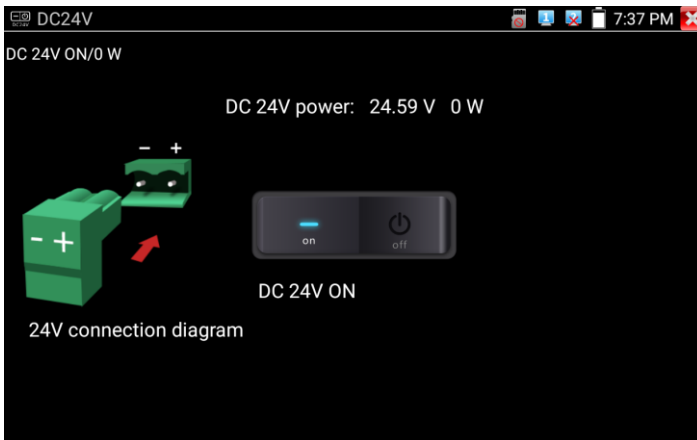

Application: Power output function is mainly used in the camera field demonstration and testing, meanwhile, for some camera installation sites, if there is no power outlet, the tester can offer temporary power for the camera.



Notice:

- a. Don't input any power into the "DC24V/2A OUTPUT" port of the tester to avoid destroy.
Man-made damage is not within our company's warranty
- b. Don't output this DC24V/2A power to DC12V/ IN port to avoid destroy. otherwise the tester will damage, and man-made damage is not within our company's warranty.
- c. The IPC tester power output is close to 2A, if the IP camera's power is over 2A, the tester will auto enter protection mode. Disconnect all the connections of the tester and then connect the tester with power adaptor to resume the tester.
- d. Make sure the tester is full charged or more than 80% charged, otherwise the tester will shows "low power", "not able to supply power"

3.3.22 Cable Test

Click icon  to enter

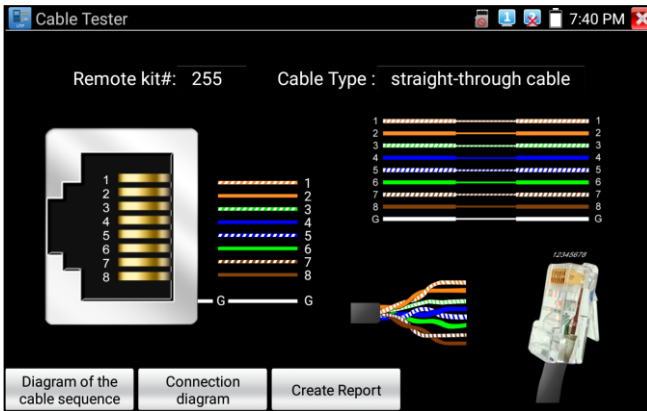

Test LAN cable or telephone cable.

Connect LAN cable or telephone cable with the CCTV tester and cable tester. And then the connecting status, cable type and the sequence of wires as well as the serial number of the cable tester kit will be displayed.

The number of the cable tester is 255.

If need several different number other types cable testers, should pay the additional cost.

Visual judgment of network cable availability:

- All sequence of cable is correct, generally corresponds to Gigabit straight/cross network cables.
- Cable sequence is wrong, but the cable is still available, generally corresponds to 100M straight-through/cross network cable.
- All sequence of cable is wrong, not available.

Meter-end/cable tester-end fault location:

Tester-end/cable tester-end display “x”, it means theRJ45 cable connector or within 1 meter from the RJ45 cable connector is faulty.

The middle part of sequence display “x”, it means theRJ45 cable connector at the end of Tester/Cable tester is normal, and there is a breakpoint 1 meter away from the RJ45 cable connector.

The middle part of sequence is not communicated and not display “x”, it means theRJ45 cable connector at the end of Tester / Cable tester is faulty, and the middle of the cable is normal.

Tester-end can performRJ45 cable connector fault detection even when the remote end is not connected to the cable tester's UTP interface.

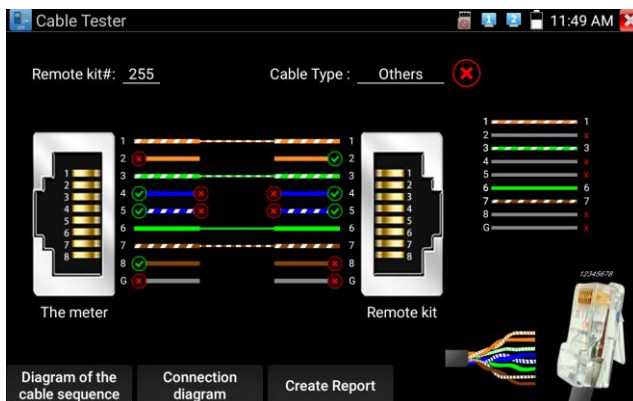

Short-circuit detection:

Supports short-circuit detection of the network cable. Testercan perform short-circuit detection even when the remote end is not connected cable tester or cable tracer.

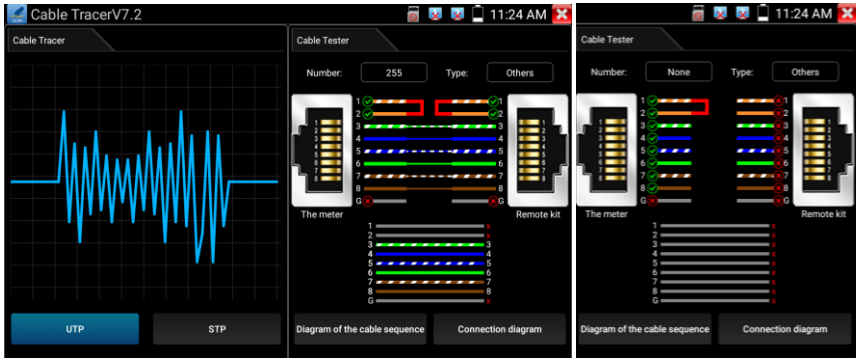

Cable test

Tap "cable test sketch map", pop up Straight-through cable and crossover cable sketch, It is for line sequence reference, when the crystal on the first pressure in the twisted-pair.

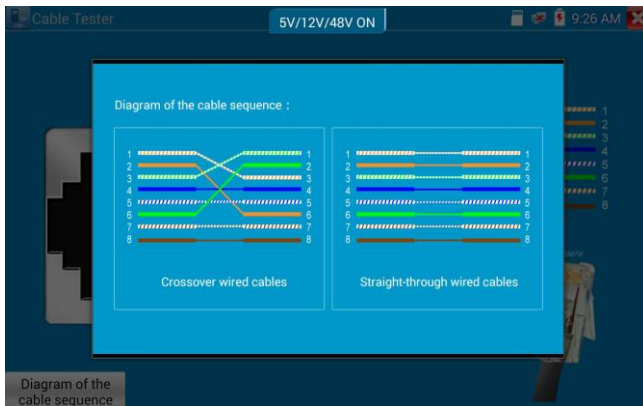

3.3.23 RJ45 cable TDR test

Connect cable to tester's LAN port, click icon "  " to enter RJ45 cable TDR test app.



Single test: Test cable status, length and attenuation.

Repeat test: Continue to test cable status, length and attenuation.

Status: After link up, screen display "online", if not link up or open circuit, screen display "open circuit", if cable pair is short circuit, screen display "short circuit".

Length: The max test length is 180 meters, when cable is open circuit or short circuit, can test the cable length, if screen display "online", the testing result would be not accurate.

Cable quality test: Green is good quality cable, Yellow is Poor quality cable, Red is water poured cable, the attenuation value will be displayed when cable over 10 meters.

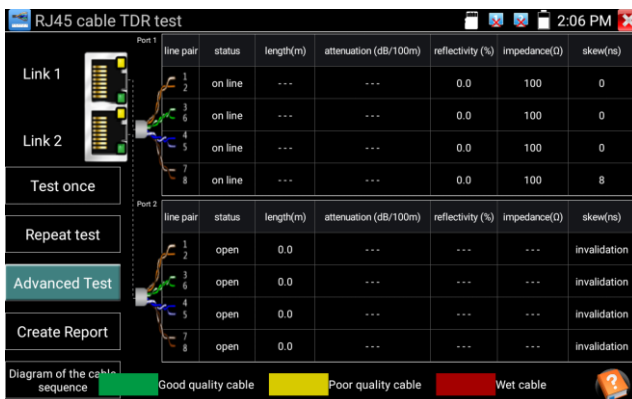

Advanced Test: Test cable pair status, length, attenuation, reflectivity, impedance, skew and other parameters.

Attenuation reflectivity: After link up, if reflectivity value is 0, it is the best quality communication

Impedance: After link up, if the impedance value is 100Ω, it is the best quality communication, the range is generally in 85-135Ω.

Skew: After 1000M link up, when skew value is 0ns, it is the best quality communication, if over 50ns, will cause a Bit Error Rate in the transmission.

Cable sequence diagram:

A straight- through and cross-over cable diagram, the cable sequence display for reference.

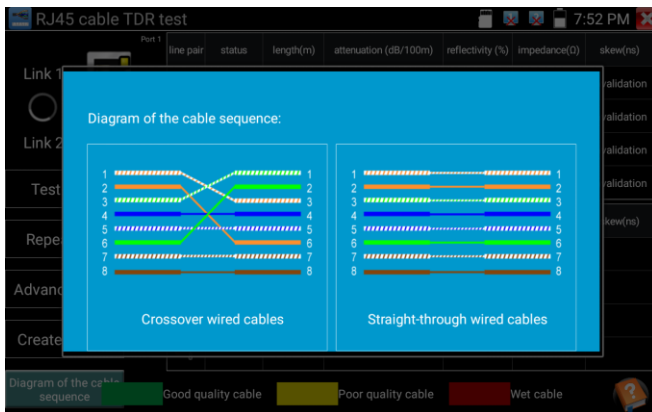

Click "Help" to check the instruction of all parameters.

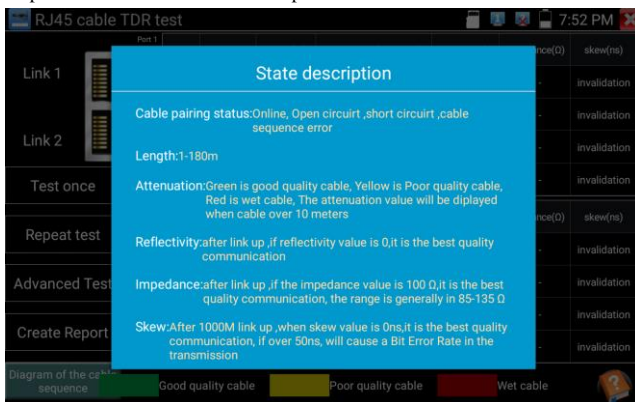

3.3.24 Cable Tracer (*Optional)

Connect tested cable or BNC cable to the UTP port or the CABLE SCAN (VIDEO OUT) port on the bottom. Click icon  to enter, click the Number on the screen to adjust audio type.

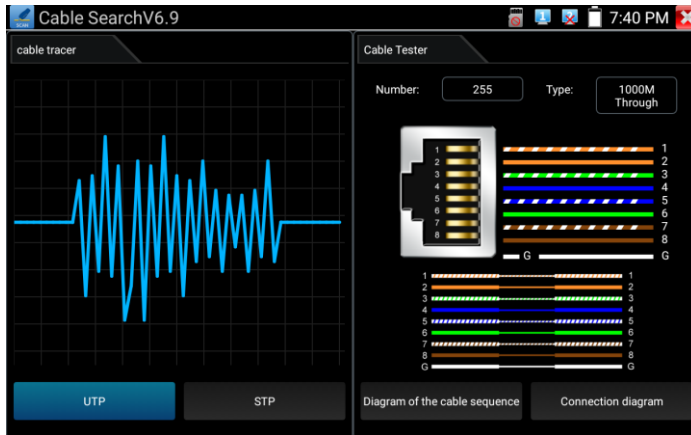

UTP mode is used for searching the normal network cable or other cables. STP mode is used for searching the shielded network cable.

Rotating the switch of cable tracer to turn on. Clockwise rotation increases sensitivity, anticlockwise rotation reduce sensitivity.

Cable tracer and Cable tester can be tested at the same time. It is better to judge whether the search network cable is accurate. Connect the other end of the tested network cable to the "UTP" port of cable tracer, the cable sequence, continuity, test box number and network cable type will be displayed on the right side of the meter interface. The "G" indicates the continuity of the shielded network cable.

The 1-8 indicators of cable tracer will flash according to the cable sequence. The DIRECT / CROSS / OTHER three indicator lights display the type of network cable directly.

Press the "MUTE" button of cable tracer for 2 seconds. After the "Di" sound, the silent mode is turned on. In the silent mode, can judge cable type according to the indicator light. Press the "MUTE" button again to exit the silent mode.

Application

It's convenient for people to find out the other end of the cable from the messy cables in security maintenance and network engineering.

While searching BNC cable, connect one port of the alligator clips to the copper core or copper net of the BNC cable, the other one to connect the earth wire (barred windows).



Note: The battery of the cable tracer must according to corresponding positive pole + and negative pole -, otherwise will damage the tester.



Note: While the cable tracer tester is receiving the audio signal from the tester, it may be influenced by other signals and make some noise.

3.3.25 TDR cable test (*Optional)



Note: The testing cable can't be connected to any equipment, otherwise it will damage the tester.

Connect Alligator clip cable to the TDR port, and the cable must connect well before testing, **otherwise** it will influence the accuracy. Built-in BNC cable, network cable, RVV control cable, Telephone line and TVVB cable etc can test. 11 groups user-defined cable can be set.

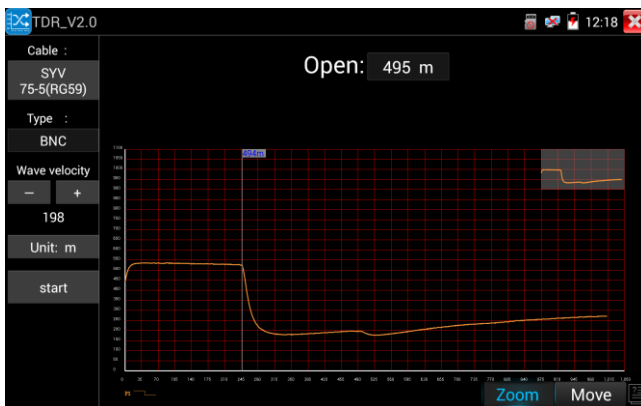

(1) Curved trajectory

1) Curve result analysis

Inflection point: The position of break point or short-circuit of the cable, is where curve suddenly rises or falls after the smooth curve.

Short circuit: The curve shows an upward trend after the inflection point

Open (break point): The curve shows a downward trend after the inflection point

2) Curve operation

Zoom: Zoom the curve. Click icon "zoom", tap the curves by two fingers or use virtual keyboard (tap the icon of the screen left edge, to call virtual keyboard)

Move: Move curve, click icon "move", and drag the curve to move.

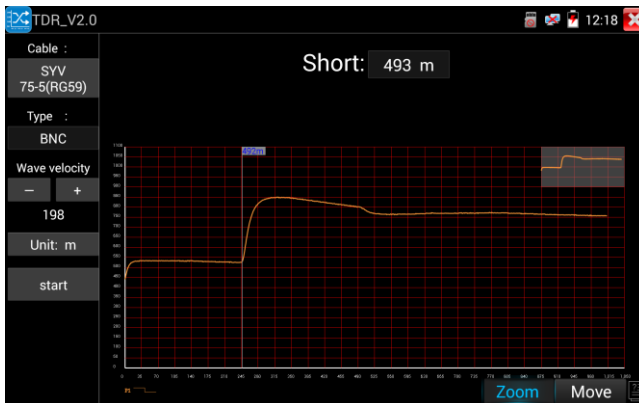

Distance bar: Display the current length, and use the virtual keyboard to move distance bar.

Curve thumbnail: Double-click the thumbnail, to restore the scaled curve

(2) Calibration

Due to differences in production processes and materials, the cable impedance of different manufacturers may be different, which will lead to large deviations in the test results. The Calibration function can be used at this time.

Click "Cable" "Type" to select cable and start testing. One tap on "Start", do one testing. If select built in cable type for testing, click "+" and "-" to adjust cable's wave speed.

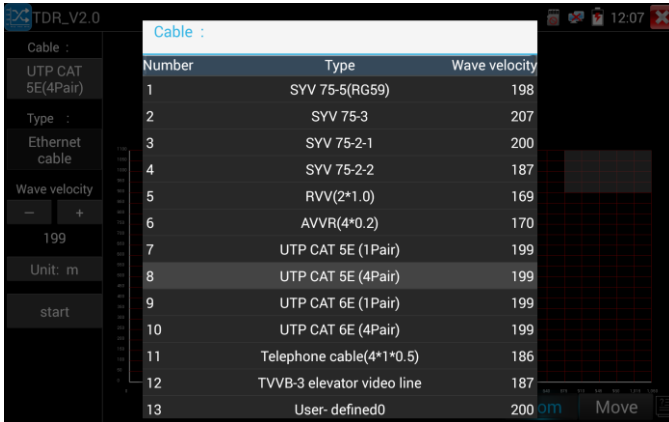

User-defined calibration: Choose the cable 100 meters to 200 meters (more than 50 meters), click "Cable", "Type" to select user-defined 1 for calibration, 11 groups user-defined can be set.

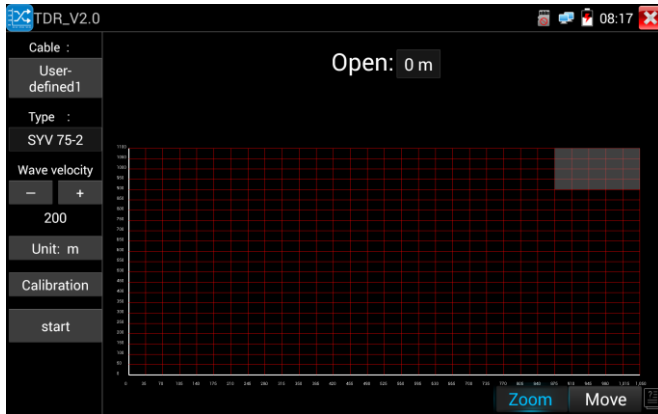

1. Select user-defined and click "Calibration" to enter test, click "user-defined 1" can define cable name, such as: AiPu BNC-5
2. Click "Cable", "Type" to select cable, and corresponding type, for example, if testing BNC cable, select "BNC", if testing communication cable 75-2, select SYV 75-2.
3. Click "+" or "-" to adjust wave speed, while display length is the same with the actual Length, click "Save" to save calibration data. It can be used for the same cable testing next time.

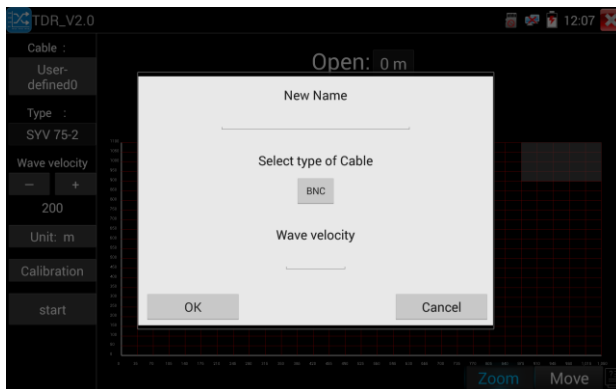

Application: TDR test is the use of pulse reflection method, to transmit pulse signal for tested cable, when cable is open circuit or short-circuit, reflected pulse is generated, the tester receives and deals with the reflected wave, measurement results displayed on the screen. TDR can test cable open circuit and short circuit, help engineer quickly find the cable's problem location. It is more convenient and efficient to repair the faulty cable.

▲Note: The TDR reflect signal could be affected by the cable quality cable's not well connected etc to cause the different TDR measurement. The TDR measurement is for reference only.

3.3.26 BNC attenuation test (*Optional)

Introduction: Through hardware high-speed sampling and processing technology, the coaxial cable transmission attenuation value can be tested in real time, which can be used to detect the attenuation of the coaxial cable through long-distance transmission and the attenuation value of different cables but at the same distance, and can detect the quality of coaxial cable.

Test Methods:

1.Connect the two alligator clip cables to the CVBS IN port and CVBS OUT port separately. Two crocodile clips red to red and black to black clip together, then click "calibration" to calibrate it.

3.3.27 PoE Voltage test

Click icon  to enter PoE voltage measurement

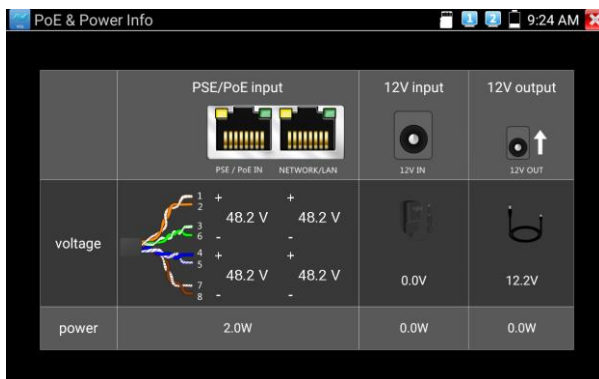

Connect a network cable from a PoE switch to the IP tester's PSE IN port. Connect an IP camera or other PoE using node to IP tester's LAN port, the PoE voltage and the cable's pin connection status show on the screen.



Note: This test is for measuring the voltage being drawn by the PoE node and the IP tester must be between the PoE switch and the PoE node for this test to work.

Note: The PoE switch must be connected to the PSE IN port. The powered device such as IP camera or other PoE node must be connected to the LAN port.



Note: Do not connect PoE power supply equipment (such as a PoE switch) to the tester's UTP/SCAN port, otherwise it will damage the tester.

PSE transmission

When PoE / PSE voltage testing, PoE/PSE connect to the tester's PSE "IN" port, the camera connect to tester's LAN port, tester not only can transmit voltage to supply power for camera, but also transmit data at the same time. as well as the computer connect to the PoE/PSE, it can log in connected tester's PoE camera.

3.3.28 12V power input test

Connect 12V power adaptor to tester's charging port, then click icon "PoE" to enter voltage measurement app, screen show the current adaptor input voltage and power. Note: the current 12V input measured power is the battery charging power and the device working power, the measured power will change depending on the different of battery power and backlight brightness.

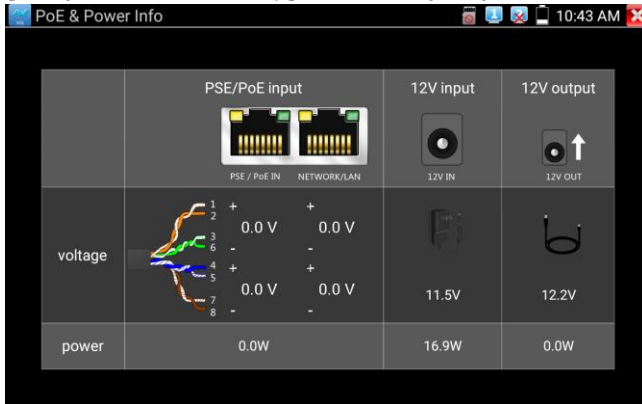

Warning: Not allow connect device with input power over 17V to tester "12V IN" port, otherwise it will damage the machine.

3.3.29 Digital Multi-meter (*Optional)

Click icon  to enter.

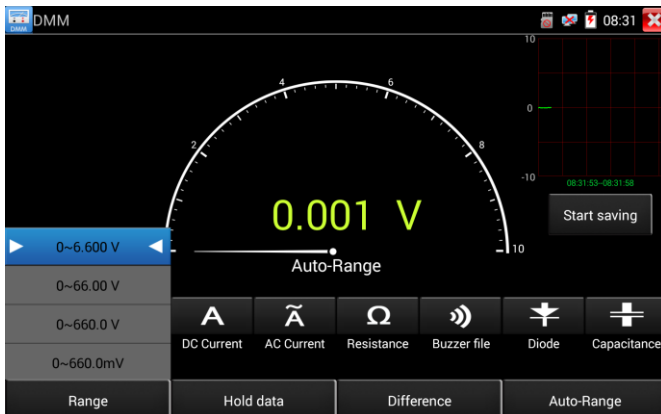

1) SYMBOLS:

- U: DC Voltage Measuring A: DC Current Measuring
- Ω: Resistance Measuring ⚡: Diode Testing
- \tilde{U} : AC Voltage Measuring \tilde{A} : AC Current Measuring
-))) : Continuity Testing $\text{||} \perp$: Capacitance Measuring

AC/DC	Voltage and current measurement state display
Auto- range	The Multimeter auto adjust the range by input signal or tested components
Data hold	Hold data
Relative measurement	Display the relative measurement value Press the key to change display state
10A socket	In 10A current measurement state ,indicate use 10A socket
Over range	The current measurement value over the range, if in the Auto range state, to switch Auto.

2) OPERATING INSTRUCTION

A. DC Voltage Measuring

WARNING!

You can't input the voltage which more than 660V DC, it's possible to show higher voltage, but it's may destroy the inner circuit.

Pay attention not to get an electric shock when measuring high voltage.

- a. Connect the black test lead to the "COM " jack and the red test lead to the "V/Ω" jack.
- b. Select \tilde{U} , enter the DC voltage measurement.
- c. the tester default Auto range status ,by click "DC auto range" , press the key can select manual range and restore auto range .

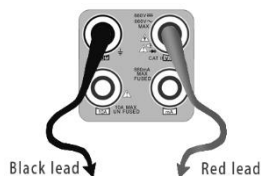

Manual range: 0.000V → 6.600V range

00.00V → 66.00V range

000.0V → 660.0V range

000.0mV → 660.0mV range

B. AC Voltage Measuring

WARNING!

You can't input the voltage which more than 660V AC, it's possible to show higher voltage, but it's may destroy the inner circuit.

Pay attention not to get an electric shock when measuring high voltage.

a. Connect the black test lead to the "COM" jack and the red test lead to the "V/Ω" jack.

b. select U ~ , enter the AC voltage measurement.

c. The tester default Auto range status, by click "AC auto range"

d. Manual range can be select, press the key "NEAR" to restore Auto range

e. Manual range: 0.000V → 6.600V range

00.00V → 66.00V range

000.0V → 660.0V range

000.0mV → 660.0mV range

C. DC Current Measuring (only manual range)

WARNING!

Shut down the power of the tested circuit, and then connect the meter with the circuit for measurement.

a. Connect the black test lead to the "COM " jack and the red test lead to the "mA" jack for a maximum of 660mA current. For a maximum of 10A, move the red lead to the 10A jack.

b. Select **A**, enter the DC current measurement, the screen display"DC current ", can select manual

range.

- c. Manual range: 0.000mA → 6.6mA range
 - 00.00mA → 66.00mA range
 - 000.0mA → 660.0mA range
 - 00.00A → 10.00A range (use 10A socket)

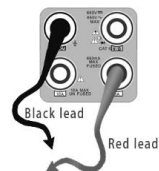

d. Select the range to enter current measurement



NOTE:

- ◆ When only the figure "OL" is displayed, it indicates over range situation and the higher range has to be selected.
- ◆ When the value scale to be measured is unknown beforehand, set the range selector at the highest position.
- ◆ The maximum current of mA socket is 660mA, over-current will destroy the fuse, and will damage the meter.
- ◆ The maximum current of 10A socket is 10A, over-current will destroy the meter, and will damage the operator.

D. AC Current Measuring (Only Manual range)

WARNING!

Shut down the power of the tested circuit, and then connect the meter with the circuit for measurement.

- a. Connect the black test lead to the "COM" jack and the red test lead to the "mA" jack for a maximum of 660mA current. For a maximum of 10A, move the red lead to the 10A jack.

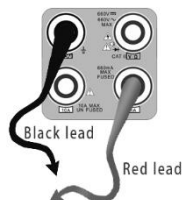

b. Select \tilde{A} , enter the AC current measurement, manually select the range.

- c. Manual range: 0.000mA → 6.600mA range
 00.00mA → 66.00mA range
 000.0mA → 660.0mA range
 00.00A → 10.00A range (use 10A socket)



Note:

- ◆ When only the figure "OL" is displayed, it indicates over range situation and the higher range has to be selected.
- ◆ When the value scale to be measured is unknown beforehand, set the range selector at the highest position.
- ◆ The maximum current of mA socket is 660mA; over-current will destroy the fuse, and will damage the meter.
- ◆ The maximum current of 10A socket is 10A, over-current will destroy the meter, and will damage the operator.
- ◆ In "AC" mode, only can input "AC", if not, will damage the meter.

E. Resistance Measuring

WARNING!

When measuring in-circuit resistance, be sure the circuit under test has all power removed and that all capacitors have discharged fully.

- a. Connect the black test lead to the "COM" jack and the red test lead to the "V/ Ω " jack.
- b. Select Ω , enter the Ω measurement
 the tester default Auto range status, Press the key manually select range, press "NEAR" to restore "Auto range"

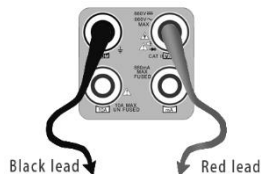

Manual range: (Connect the red lead to black leads, will display the measure range)

- 000.0Ω → 660Ω range
- 0.000 KΩ → 6.600KΩ range
- 00.00 KΩ → 66.00KΩ range
- 000.0 KΩ → 660.0KΩ range
- 0.000 MΩ → 6.600MΩ range
- 00.00 MΩ → 66.00MΩ range

F. Continuity Testing

WARNING!

When testing the circuit continuity, be sure that the power of the circuit has been shut down and all capacitors have been discharged fully.

- a. Connect the black test lead to the "COM" jack and the red test lead to the "V/Ω" jack.
- b. Select ⌋ , enter the continuity test, Connect test leads across two point of the circuit under testing.
- c. If continuity exists (i.e., resistance less than about 50Ω), built-in buzzer will sound.

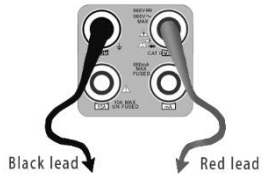

G. Diode Testing

WARNING!

The capacitance of a capacitor should be tested separately, should not test in the installation of circuit.

- a. Connect the black test lead to the "COM" jack and the red test lead to the "V/Ω" jack. (the red lead anode "+")
- b. Select ⌋ , enter the diode testing.
- c. Connect test red lead across to the anode, the black lead to the cathode of the diode under testing.

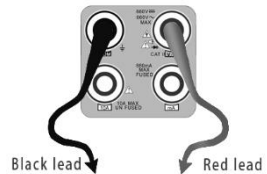

- d. Connect test red lead across to the cathode, the black lead to the anode of the diode under testing.
- e. Tested diode, forward voltage low 30m, there is sound indication, then can finish the testing quickly without view the screen.

H. Capacitance Measuring

WARNING!

To avoid electric shock, be sure the capacitors have been discharged fully before measuring the capacitance of a capacitor.

- a. Connect the black test lead to the "COM " jack and the red test lead to the "V/ Ω " jack.
- b. Select " C ", enter the capacitance measurement.
- c. The tester default auto range status, and manual range by press upward and downward key, Auto rang by press the key "NEAR"

Manual range: 0.000nF	→	6.600nF range
00.00nF	→	66.00nF range
000.0nF	→	660.0nF range
0.000uF	→	6.600μF range
00.00uF	→	66.00μF range
000.0uF	→	660.0μF range
0.000mF	→	6.600mF range
00.00mF	→	66.00mF range

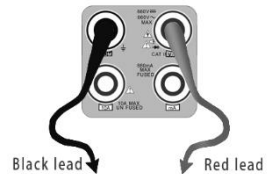

- d. Before connect test leads across two sides of the capacitor under measurement, be sure that the capacitor has been discharged fully.



- a. The capacitance of a capacitor should be tested separately, should not test in the installation of circuit.
- b. To avoid electric shock, be sure the capacitors have been discharged fully before measuring the capacitance of a capacitor.

- c. While testing the capacitance of a capacitor to 660uF, the Max time will be 6.6 seconds, if the capacitor is leaked or damaged, the data can't be read.

The tester will be normal after disconnecting the capacitor.

Manual range and Auto range

When testing, click "Range select" to change the value, click "Auto range" to enter Auto measurement.

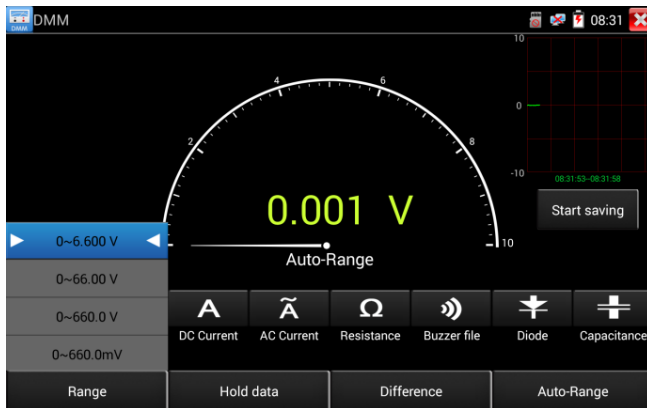

Data hold

Click "Hold data" to enter, the data be hold, the value is green. Press it again to quit.

Relative value measurement

Click "Relative" to enter, the tester Auto-save the data, the displayed new measurement and relative value is red color. Press it again to quit.

The hold function and the relative value be combined use, the display value is yellow

The meter protection

➤ Voltage protection

You can't input the voltage which more than 660V AC, it's possible to show higher voltage, but it's may destroy the inner circuit.

➤ Resistance, Continuity, Diode, PTC component Protection

Wrong input voltage, will Auto enter protection state, it only suitable for short and limit time work.

If input voltage over 600V, will damage the meter.

➤ **mA current fuse range: 250V 1A**

if the current over the rated range ,fuse will melt to protect the meter .Pls use the same model when change the fuse, Pls opens the battery cover to change.



Note: 10A socket without fuse protection, if over the current range

Wrong using the 10A socket to measure the voltage, will damage the meter.

3.3.30 Optical power meter (*Optional)

Click icon  to enter ,with five wavelength 1625nm,1550nm, 1490nm, 1310nm,1300nm, 850nm, linear or nonlinear optical power display, both for optical power testing and Fiber link loss relative measurement. It is necessary tool for installation and maintenance optical fiber communication, cable television and CCTV security system.



Note: Please keep the fiber connector and the dust cap be clean, and clean the detector with the special alcohol.

Data hold

While testing, click "Hold" to data hold, the data will not change. It's convenient to read. Press again to quit.

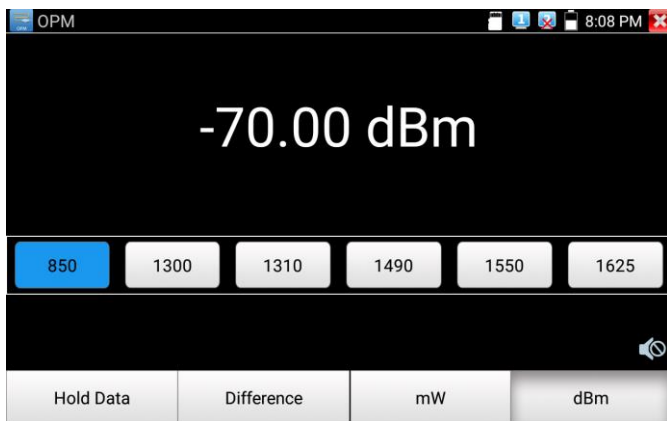

Relative power value (optical link loss) measurement

While testing, set the wavelength for measurement. Click "relative"(difference) to test, the tester Auto save current fiber power value as the base reference value. Input another optical fiber to be measured, the displayed new measurement and relative value is red color. Press it again to quit.



Data hold and Relative measuring use together, the data is yellow while the function is effect.



3.3.31 Visual Fault Locator (*Optional)

Click icon  to enter

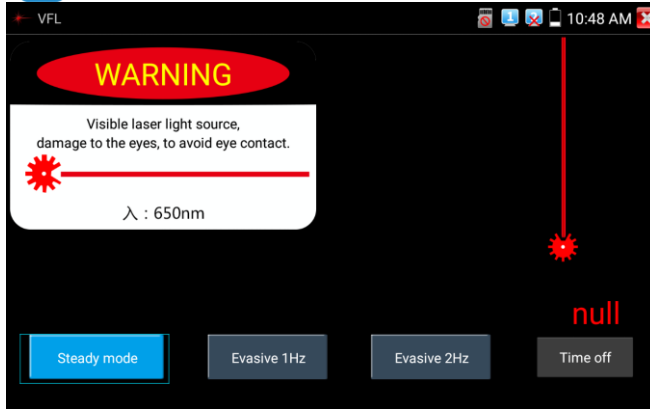

VFL four status can select——"Steady mode", "Evasive 1Hz", "Evasive 2Hz"and "Time off". Click button "Steady mode" to enter steady status, click button "Evasive 1Hz" and "Evasive 2Hz", to enter pulse mode, click button "Time off ", VFL is turned off. Timed turn off can select (5 mins, 10 mins, 30 mins, 60 mins and 120 mins).

Click "Steady mode", red laser source emits steady, click again to quit.

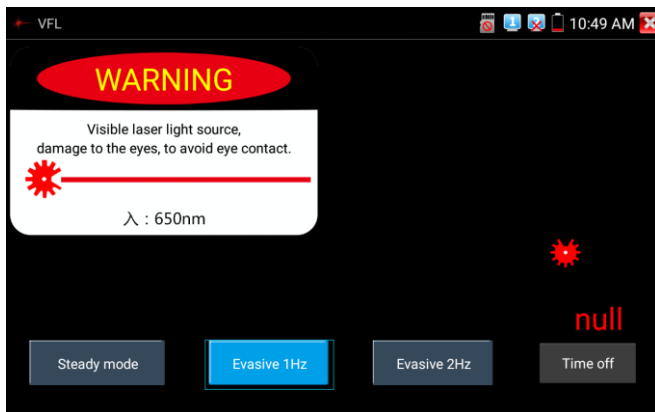

Click icons "Evasive 1Hz"or "Evasive 2Hz" to enter pulse mode, the red laser source is emitted by a certain frequency, press it again to quit

3.3.32 Audio Record

Connect an audio device to the IP tester's audio input port. Click the  icon to enter the Audio Recorder app. Click the red button to stop, and the unit will prompt you to save the recording.

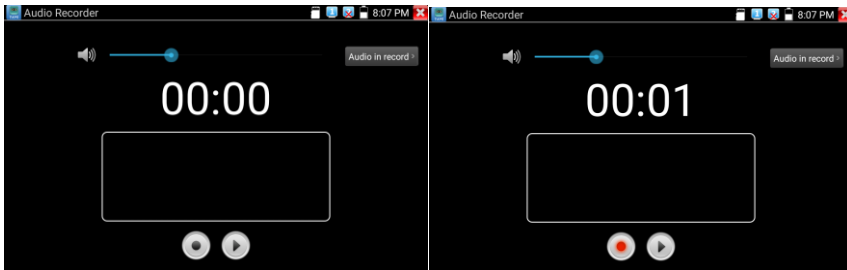

3.3.33 Data monitor

Please click icon  to enter

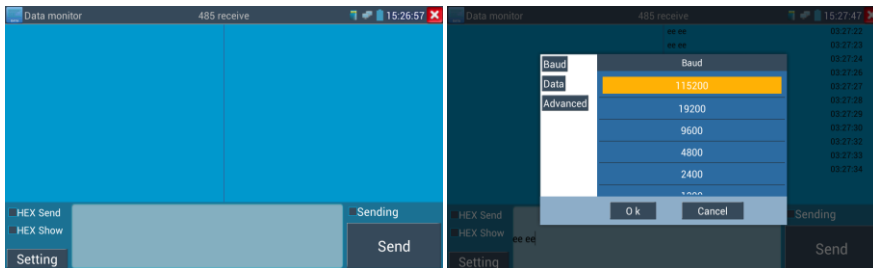

Click "Setting" to choose the baud rate of RS485, it must be the same as the DVR or the Control keyboard. The DVR or Control keyboard send the code to the tester, if it can be read, the protocol will shown on the upper right, like Pelco D, if not, like P:--

While the tester receives the code, press the  key to empty.

Though the RS485 port, display the PTZ control code of the multifunctional keyboard or the DVR.

Controller can check the status of the RS485 transmission through the code on the display. (The RS485 communication rate must be the same.)

Application: Check the RS485 communication states of the video optical transmitter whether normal.

Engineer can analyze the protocol and check the data through the displayed code.

3.3.34 Audio player

Click the icon  to enter . The audio player only supports MP3 format Audio files.

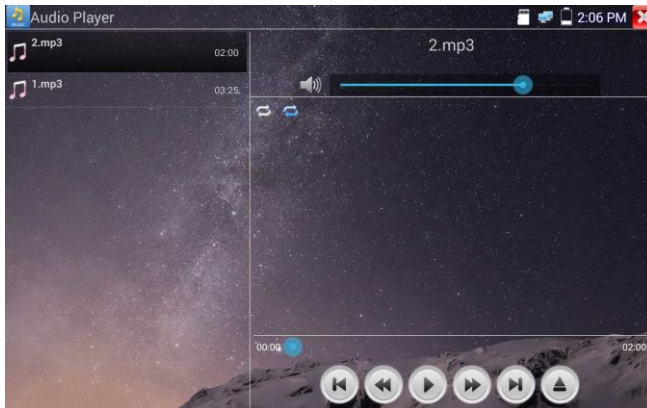

3.3.35 Media Player

Click the icon  to enter

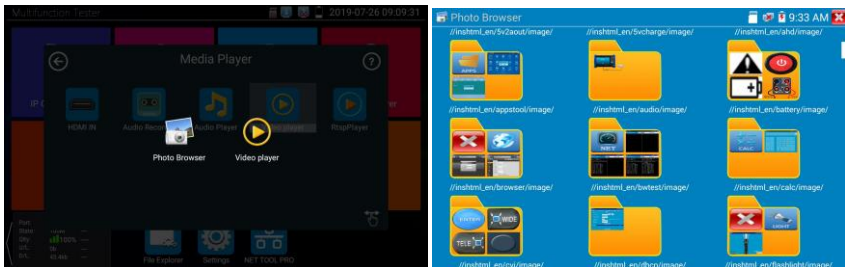

The Media player can browse video and image files. It supports the video formats of MP4, H.264, MPEG4, and MKV. The IP tester recorded files can play directly via the Media player. The Media player will automatically display the video files from the SD card. Click on the desired file to play. Click RETURN to exit.

To rename or delete an existing file, press the file name for a few seconds until the screen below appears. You can then rename or delete the file by pressing the desired option.

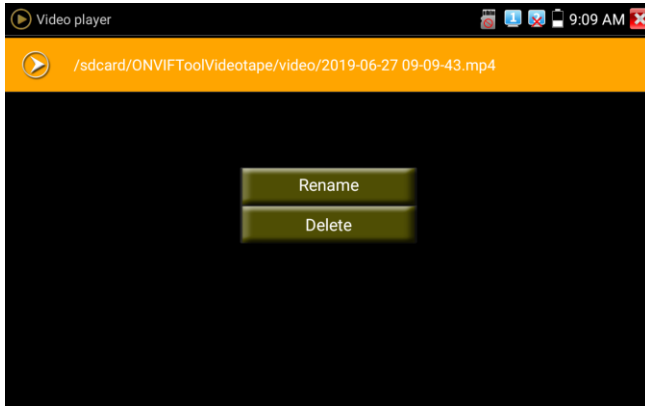

3.3.36 RTSP Player

The RTSP Player app will allow you to view the RTSP video stream from an IP camera. If you were unable to view your camera via the ONVIF or IPC Test apps, it is possible your camera will have an RTSP stream and you can view live video.

From the main menu, select the "APP Tool" folder and then select the "RTSP Player" to open the app. If the IP camera uses MJPEG, select the RTSP icon. If the IP camera uses H.264, select the "RTSP HD" icon.

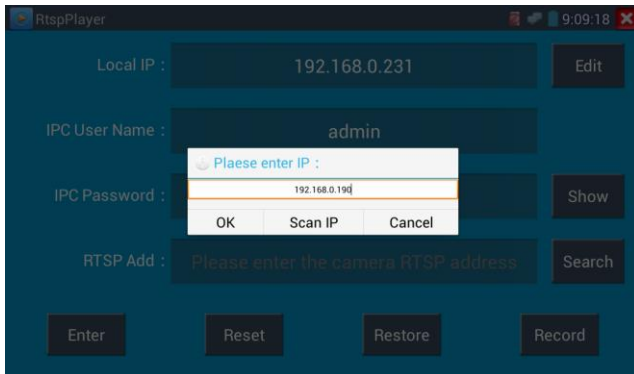

Local IP: This is the IP testers IP address.

RTSP Add: This is where you can manually enter the IP camera's RTSP URL or click on Search to search the network for cameras that use an RTSP stream.

IPC Username: Enter the IP camera's user name.

IPC Password: Enter the IP camera's password.

Once you have entered all the necessary information, select Enter at the bottom left to view the RTSP stream.

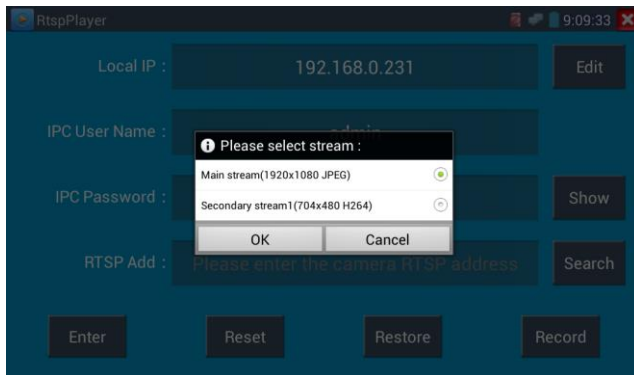

Note: In the event the IPC tester does not auto detect the RTSP stream, refer to the specific camera manufacturer for the specific RTSP stream URL. you may find this on line with a search of the camera model number and the word RTSP.

3.3.37 Hik test tool

Hik test tool app is design for activating and debugging Hikvision camera, can auto-identify inactivated hikvision camera, also can display image from the Hikvision camera.

Tap icon  to enter

1. **Activation:** Select left [online detection] to display the "inactivated" camera and click activate.



"Activation" and "Batch activation" are optional.

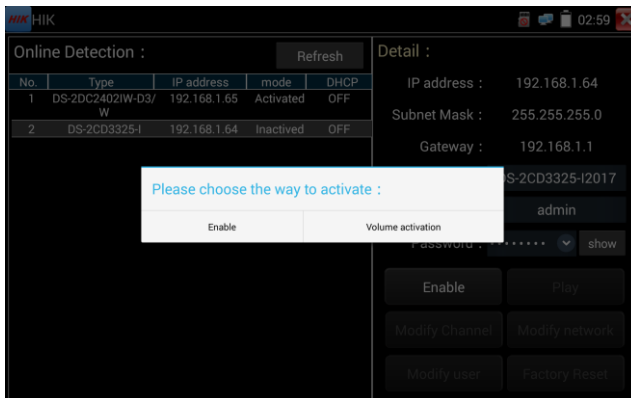

Auto open ONVIF protocol: After activation, the new HIK cameras click "play, modify the channel name, modify network information, modify user information" any one of to auto open the selected camera ONVIF protocol.

Play: Security status shows the "activated" camera. Enter the correct camera password in the right [password] and click [play] to pop up the "private protocol" or "speed ONVIF" two options. Select the protocol you need to see the camera images.

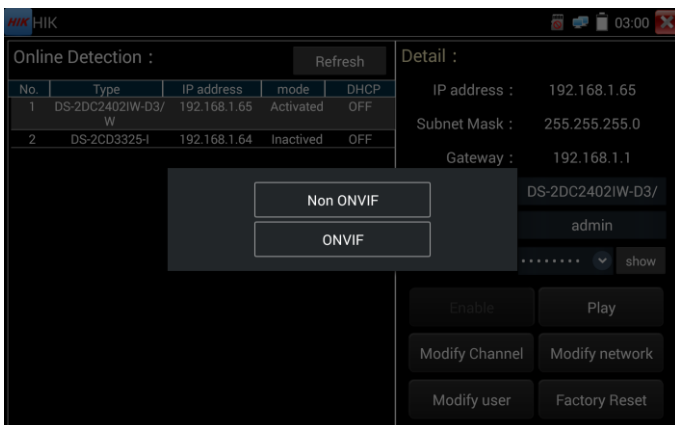

Modify channel name: Clicking "Modify the channel name" will pop up OSD settings, including time, channel name and other optional items.

After channel selecting, you can edit the channel name, modify the display position, and switch the font size. Select "default location" in "content location" is without modification. Select "Customization" to arbitrarily adjust the channel name and display location. Click "OK" and the effects will appear. Press return key or click any area of the screen to return to the upper layer of the interface.

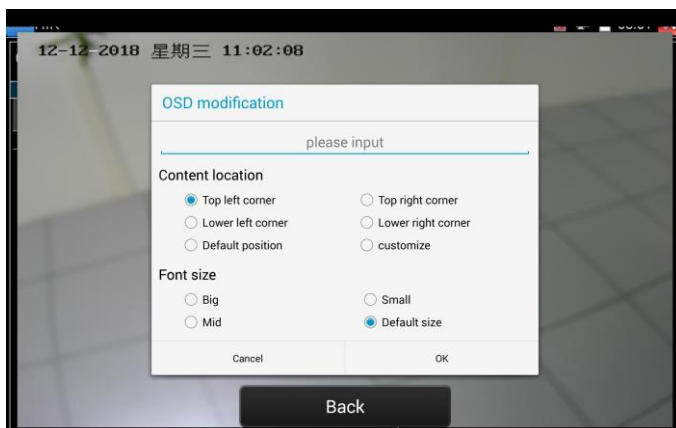

Modify network information: Support "modify" and "batch modify" camera IP address, subnet mask and other parameters modification.

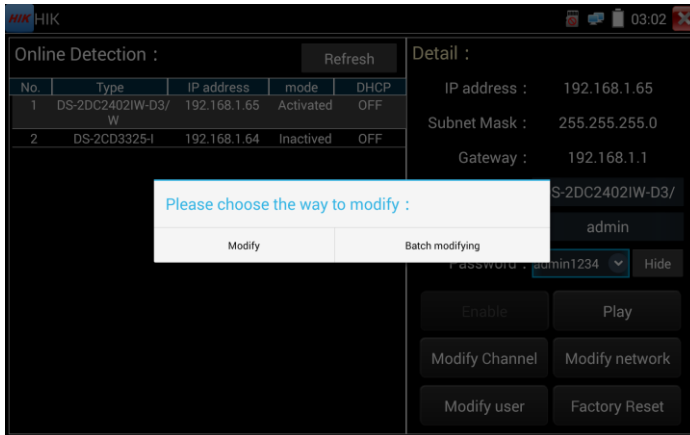

Enter a new IP address and subnet mask, the default gateway will be auto modified according to the IP address. Click "OK" to save the changes.

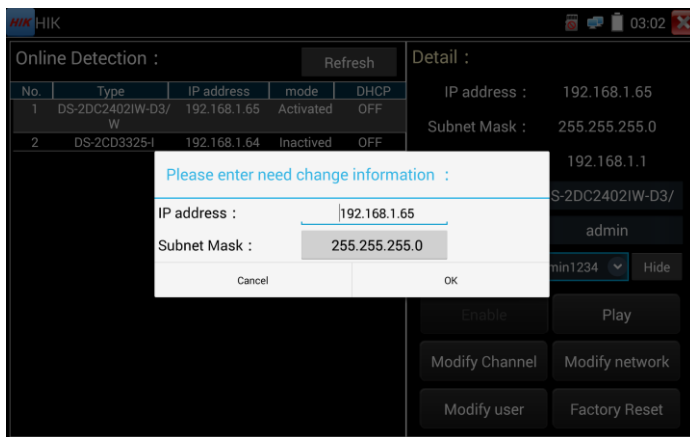

Modify user information: Modify the camera's user name and password.

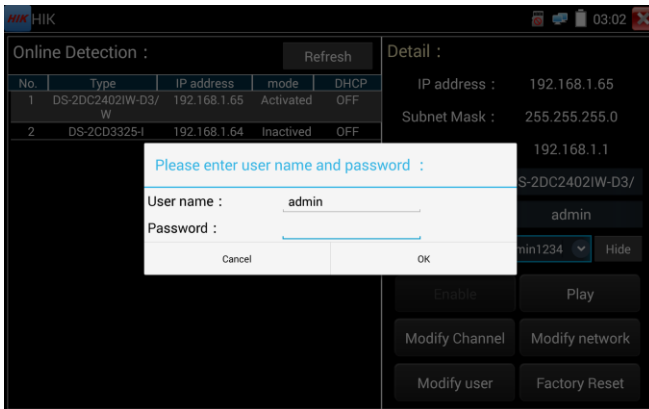

Factory Reset: Camera factory reset.

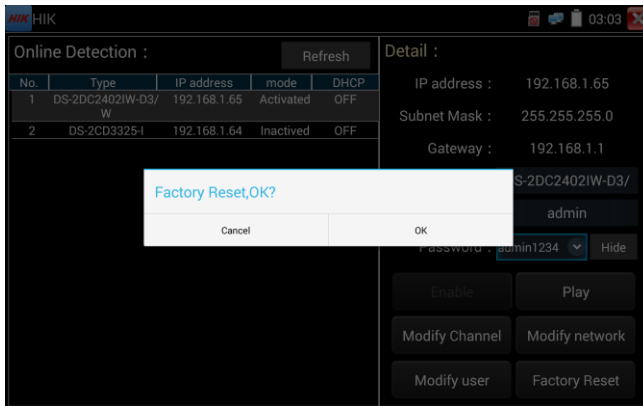

3.3.38 Dahua test tool

Dahua test tool is developed for installation and debugging of the Dahua IP camera, it can display image, and modify IP, user name and password etc. Making Dahua camera test more convenient and quickly.

Activation: select left [online detection] to display the "inactivated" camera and click activate.

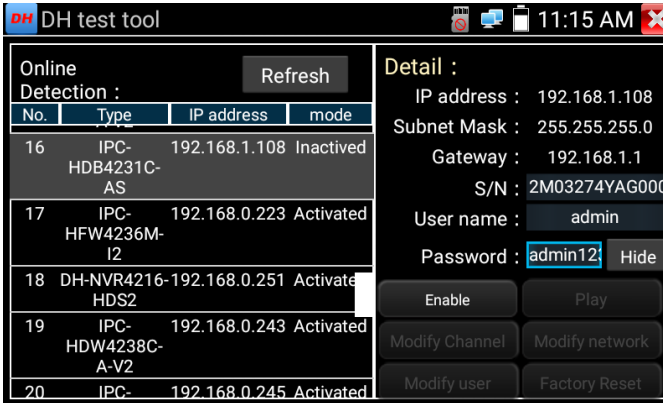

Activate and Batch activate are optional, support reserved phone number for resetting password.

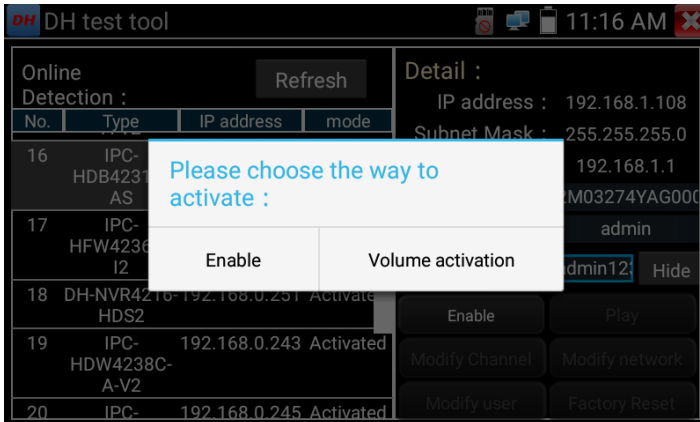

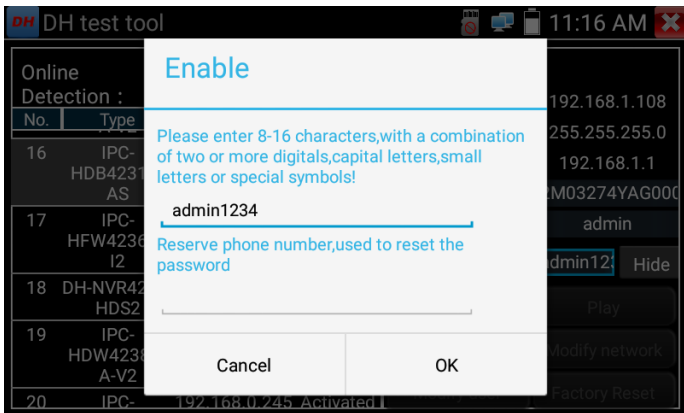

Play: When mode display "activated" camera, input correct password, click "Play" popping up "private protocol" and "ONVIF", Select correspond protocol to view the camera image.



Modify Channel: Click "Modify Channel", will pop up OSD setting, includes time, channel name,etc



After selected Channel name, can edit channel name, modify the display position and font size. If select "Default position" of Content location, then no need to modify. If select "customize", then can modify Channel name and display position, click "OK" to view the image. Click "Back" or "Return" button to return previous interface.

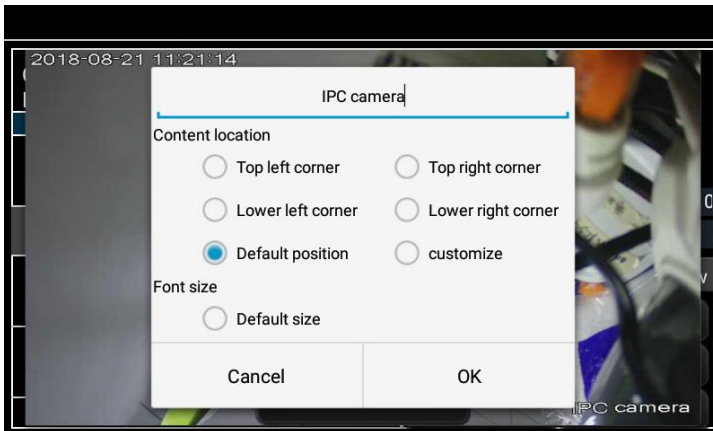

Modify Network: Support Modify and batch modify two way, can modify camera IP address, Subnet mask and gateway.

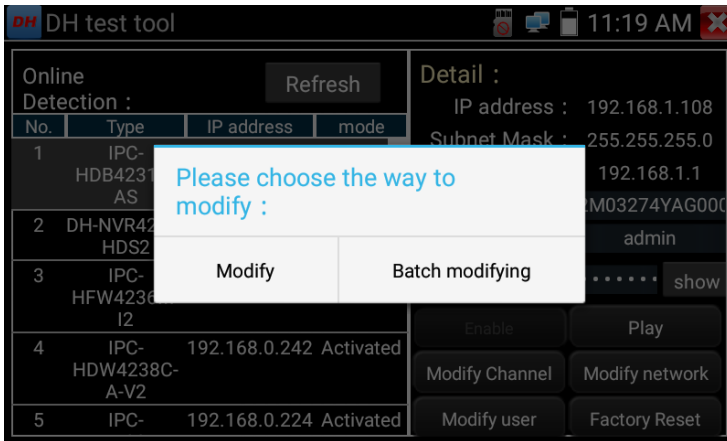

Input new IP address, need to input password, click "OK" to save the modification

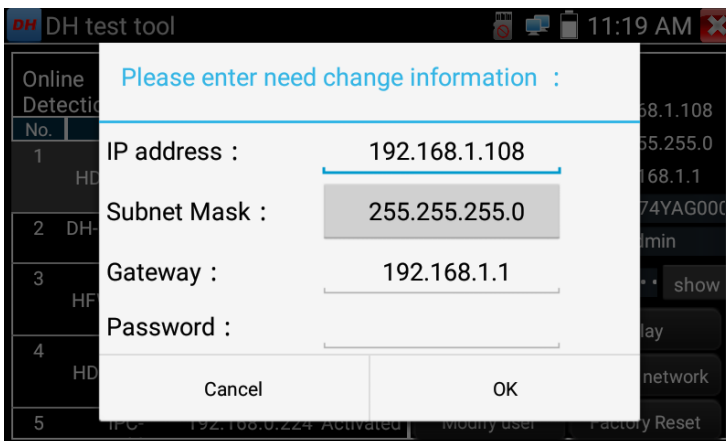

Modify user information: Modify camera user name and password, which is onvif, Dahua test tool, IPC TESTE user name and password, not web user name and password.

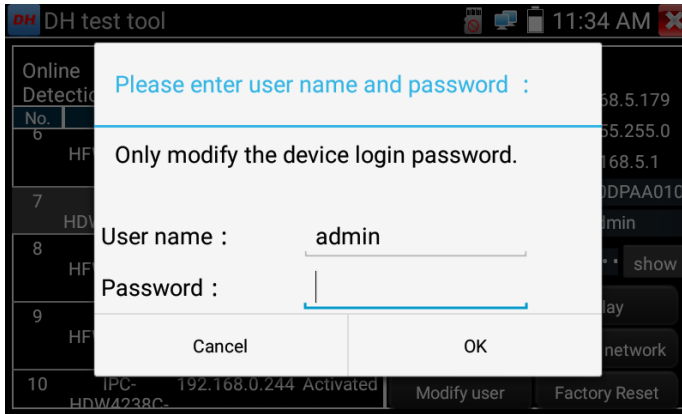

Factory reset setting: Camera will be soft reset, and the device's user name, password and network set be saved. Other settings information is factory reset.

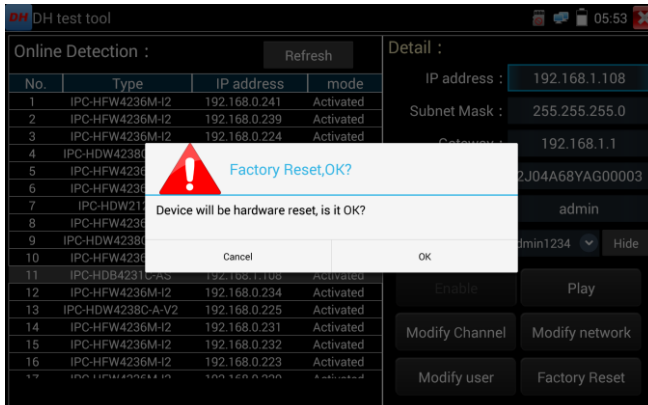

3.3.39 Update

Copy the downloaded update file to SD card "update" directory, if no directory, please create one.

Click the  icon to open the Update menu. Select "Local Update" to update via the SD card or select "Online Update" to check for updates on the internet. If there are applications that need updating, the applications will be displayed on the

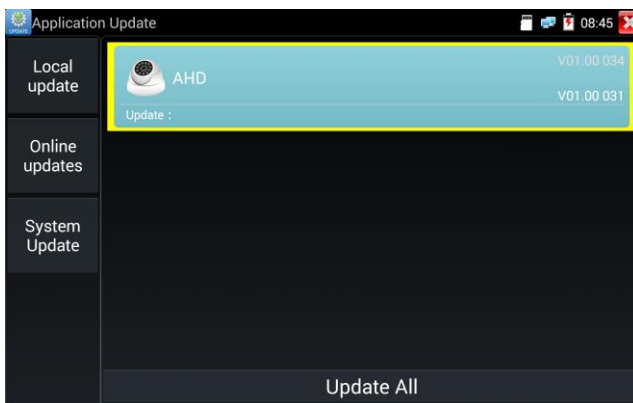

If there are update programs, applications will be listed in the interface, click related applications, update to the latest version.

Update online: Before using online update, need enter settings-user management to register first.

System update: Connect the Internet to update systems.

3.3.40 Office

Quick office app (support excel, word, ppt format) doc. editable

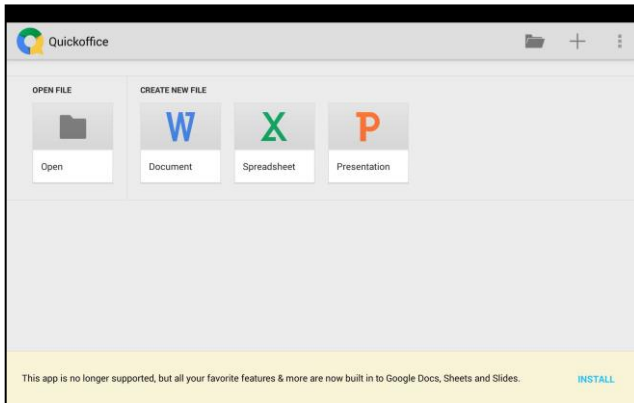

3.3.41 LED Flashlight

It is convenient for the installation or maintenance in the evening or in the dark. Click on  to enter

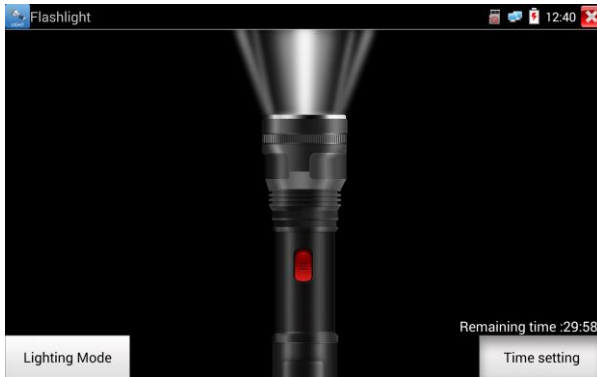

While in the flashlight app, click the red button to turn on the LED lamp. Press it again to turn it off. If you don't press the red button  to shut off the lamp and press the button to exit the app, the lamp will stay on. Click the Time Setting button to set a timer that will shut off the lamp.

3.3.42 Browser

Click icon  to enter

Type in the 's IP address and press "Go" to access the IP camera's interface.

NOTE: You will not be able to view live video in the web browser. For viewing video, use the IP tester's live camera view Apps

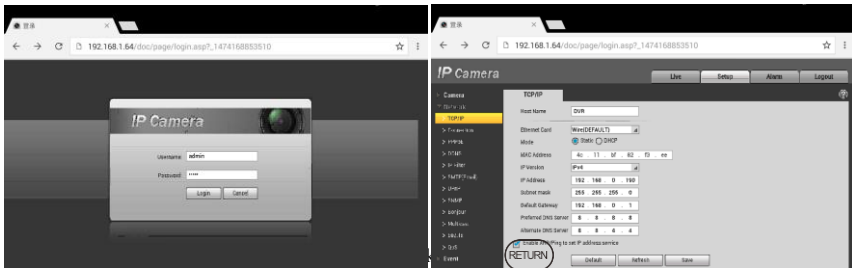



camera. If they are not in the same segment, click the button  or press "RETRUN" to exit. Open the "Settings" app from the main menu to change the IP tester's network settings to match those of the IP camera.

3.3.43 Notepad

Notepad can be used to record the important testing results, click the key "Save" to save the contents.

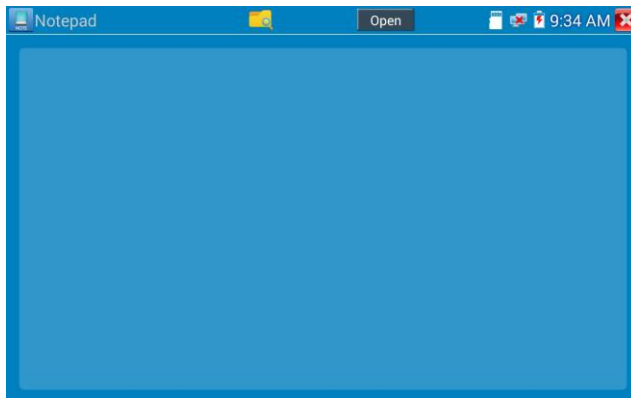
Notepad can auto record the storage date and time.



Please click  to view the notepad, all saving contents display. Click each record bar to show the details. Press the record bar for several seconds, prompt whether delete it.

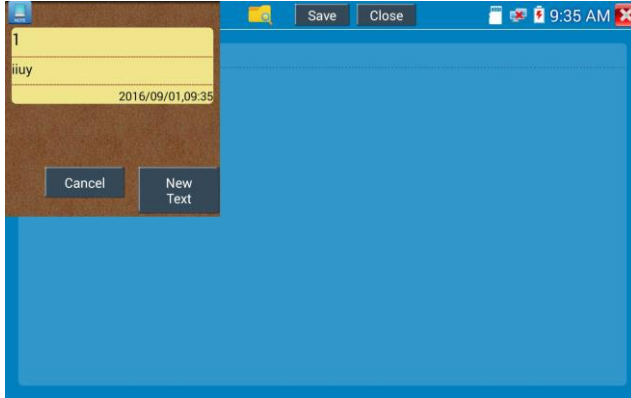

3.3.44 System Setting

Click icon  to enter

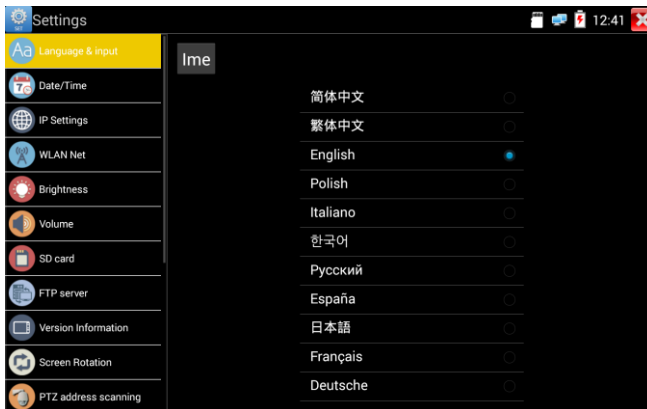

Language: Select your desired language: English, Chinese, Korean, Russian, Italian, Polish, Spanish, French or Japanese, German, Turkish, etc.

Typewriting: You can select typewriting or install other typewriting:

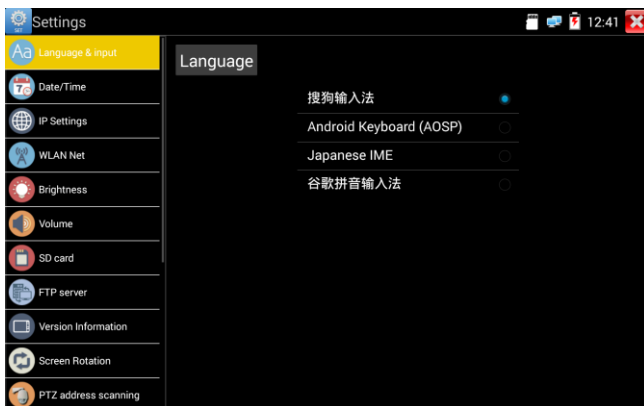

Date/Time: Set the Date/time of the IP tester

IP setting: Manually set the IP address, Subnet Mask, Default Gateway and DNS address or select "Dynamic allocation" to use DHCP. To test multiple network segments, click "Advanced " and then click "Add " to enter another IP address for the IP tester.

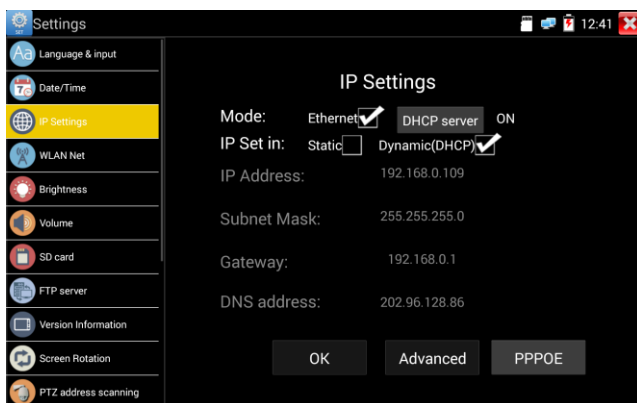

After setting an advanced IP address (refer to the photos above), the unit can test two network segments (192.168.5.0) and (192.168.1.0)

WLAN Net: Turn WiFi off or on by pressing the "Open the wifi" button. Once WiFi is turned on, and click connected WIFI, it will scan for wireless networks in your area.

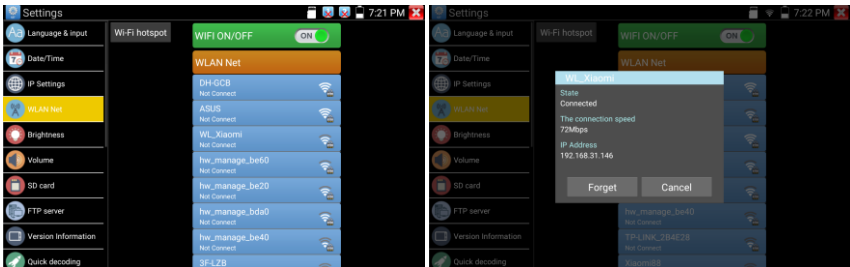

Select and press "WIFI" several seconds, to set static IP address.

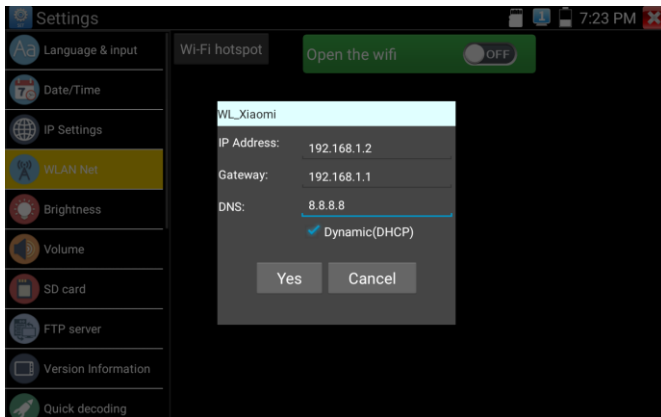

Wi-Fi hotspot: Input "SSID" name and "password", and then click "ok" to create Wi-Fi hotspot.



Brightness: Set the desired brightness of the IP tester and adjust the sleep time settings.

Volume: Set volume level

SD Card: Displays SD Card Capacity. You can also format the SD card or unmount it before removing it.

FTP server: Once the IP tester connects to a network, a computer can be used to read the SD card files via FTP

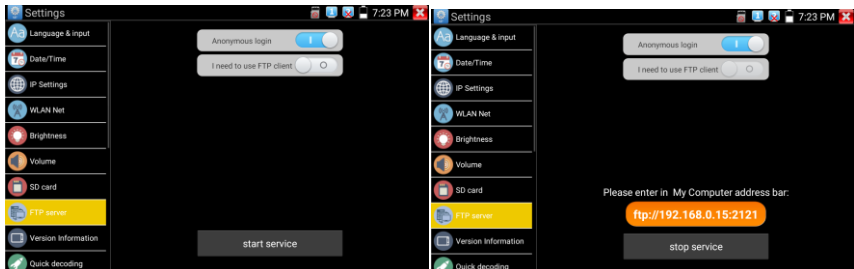

Start the FTP server and then input the tester's FTP address in the PC's address bar. This will enable the PC to read, copy and edit the files from the SD card without the use of SD card reader.

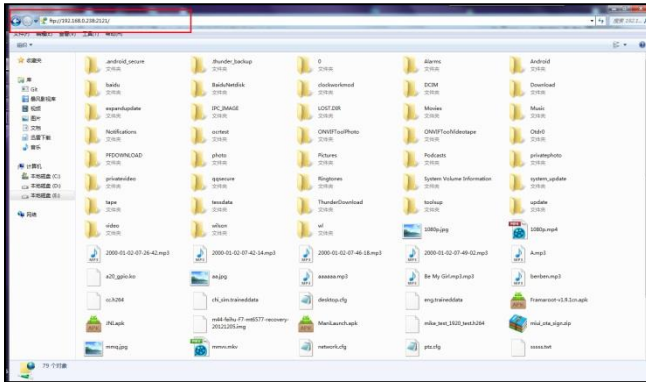

Version Information: Shows applications version information, if press any apps icon several seconds to uninstall.

Screen display rotation: Click on "Screen Rotation" to flip the IP tester's display 180 degrees. This function is very convenient for the user to connect the LAN cable on the bottom of the unit without having to flip the unit itself.

PTZ address scan: You can toggle the PTZ Address scan off or on before entering the " PTZ controller" app. This needs to be turned on in order to use the PTZ Scan feature of the PTZ app.

Online Registration: Online update need register first, after the tester connect to network, then fill registration information to register.

User Feedback: If you have any comments or suggestions for the tester, please connect it to network and write your feedback.

Lock Screen: The meter default is not locked. You can choose password Lock screen, pattern Lock screen or "NO".

Password Lock Screen: Set password, you can input digitals, letters or characters as password, input it again to confirm .when the meter is in standby mode or turn it on, you can input your password to enter.

Pattern Lock Screen: Drawing a pattern to lock. While the meter is in standby mode or turn it on, you can input your pattern to enter.

Modify Lock screen password, you need input lock password again. Select password Lock screen or pattern Lock screen to reset lock screen password. After reset pattern lock screen, you need to draw a new lock pattern.

Restore the factory settings: If the tester to restore factory settings, all your personal files and apps will be removed.

3.3.45 File explorer

Click "File" on the top bar tool, can select internal or external storage. Click on the upper right corner Icon "...". will pop-up menu, you can select other operation or exit.



Browse

It includes Music, Videos, Pictures, Documents, zip file etc. It is convenient to view and manager.

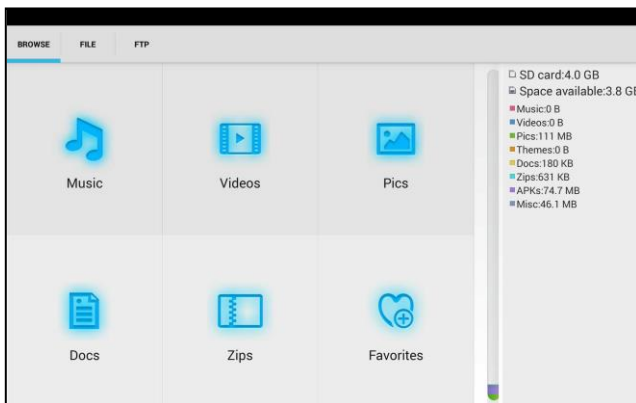

FTP server

You can choose internal or external SD card.

Other operation details, Please refer to FTP settings.

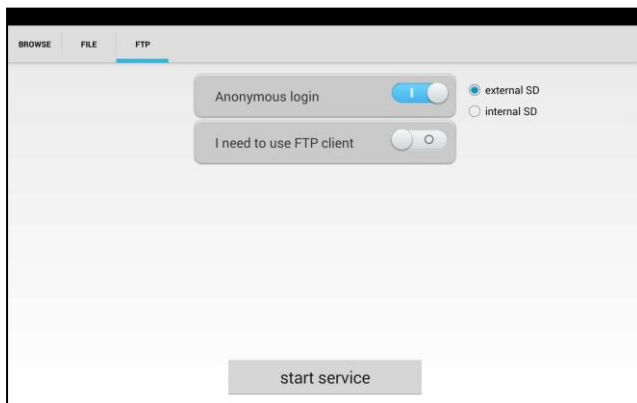

3.3.46 Theme

Desktop style: you can select Lite mode or normal mode.

Theme:

Pressing square area's any color icon several seconds, the selected color icon will be auto move the rectangle area, if you press selected color several seconds, and it will be auto deleted.

Theme colors include fixed order and random order, and click "set" to save.

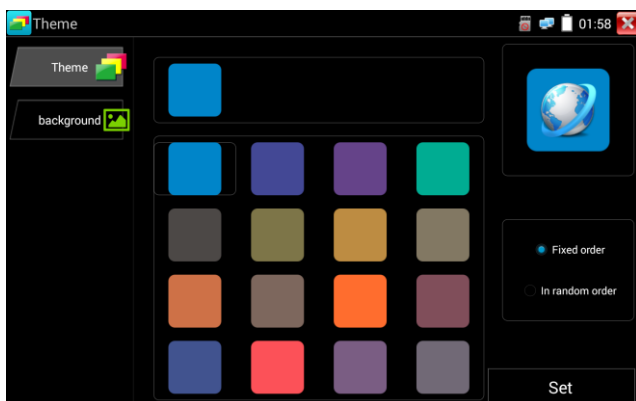

Color

When set background color, you can select colors from Color Phase, and also can input color's RGB to set.

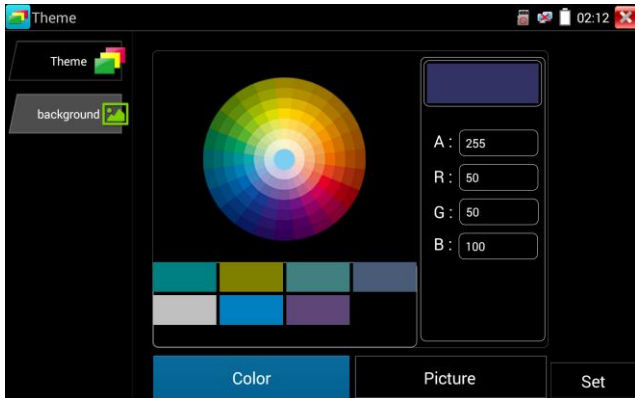

After finished color setting, click "set" to set it as desktop or application background.

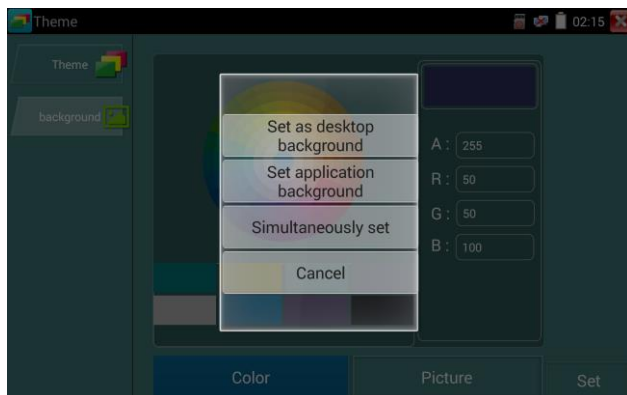

Set as desktop background: Setting color as desktop background.

Set as application background: Set color as application background.

Set at the same time: Setting color as desktop background and application background.

Cancel: Cancel current setting.

Picture:

Click Picture to select one, and set as temporarily background to view setting effect. Click "more" to select pictures from local file, and click set to set picture as background.

3.3.47 Audio test

You can test the audio input from audio pickup devices by connecting the audio pickup device to the IP tester with the supplied audio cable.



4. Specifications

4.1 General Specifications

Model	IP Camera Tester 【*】 models Optional
Display	7 inch retina touch screen, 1920*1200 resolution
Network port	10/100/1000Mbps auto adjust, RJ45, Dual LAN port
WIFI	Built in WIFI, speeds 150M, allows you to connect to a wireless network and view IP cameras

H.265 Mainstream test	New hardware decoding, 4K H.265/H.264 camera image display by mainstream testing
IP discovery	Auto-scan the whole network segment camera IP
Rapid ONVIF	Search camera quickly, auto log in and display image from the camera, activate Hikvision camera
Hik test tool	Batch activate Hikvision camera, display image from the camera, modify Channel, batch modify IP, user name and password parameters etc.
DH test tool	Batch activate Dahua camera, batch modify IP, modify Channel, user name and password parameters etc.
IP camera type	ONVIF, ONVIF PTZ, Dahua IPC-HFW2100P, Hikvision DS-2CD864-E13, Samsung SNZ-5200, Tiandy TD-NC9200S2, Kodak IPC120L, Honeywell HICC-2300T, RTSP Viewer
AutoHD* (Optional)	Auto-recognize the resolution and Auto-display the image of the connected camera. Support coaxial PTZ control and call OSD menu, support up to 8MP TVI/CVI/AHD and CVBS cameras.
4K HD Coaxial level test* (Optional)	Through hardware high-speed sampling and processing technology, accurately measure video peak level, sync level and burst level. By one key to create testing report.
SDI video signal test * (Optional)	1 channel HD-SDI/EX-SDI input (BNC interface), resolution support: 720P 60fps, 1080P 60fps, 1080i 60fps, EX-SDI: 2560 x1440P /25/30fps, 3840 x 2160P 20/30 fps, UTC control and call OSD menu
CVI video signal test * (Optional)	1 channel CVI input (BNC interface, resolution support 720P 25/30/50/60fps, 1080P 25/30fps, 2560x1440P 25/30fps, 2592x1944 20fps, 2960x1920 20fps, 3840x2160 12.5/15 fps. UTC control and call OSD menu
TVI video signal test* (Optional)	1 channel TVI input (BNC interface) ,resolution support 720P 25/30/50/60fps, 1080P 25/30fps, 2048x1536P 18/25/30fps, 2688x1520P 15fps, 2560x1440P 15/25/30fps, 2560x1944P 12.5/20fps, 3840 x 2160 12.5/15 fps, UTC control and call OSD menu

AHD video signal test * (Optional)	1 channel AHD input (BNC interface) ,resolution support 720P 25/30fps, 1080P 25/30fps, 2048x1536P 18/25/30fps, 2560x1440P 15/25/30fps, 2560x1944P 12.5/20fps, 3840 x 2160P 15 fps, UTC control and call OSD menu
Analog video test	1 channel BNC Input & 1 channel BNC Output, NTSC/PAL (Auto adapt)
Video level meter	PEAK video signal level, SYNC signal level, COLOR BURST chroma level measurement for CVBS camera.
Zoom Image	Supports Analog and IP camera image zooming & movement
Snapshot, Video record and playback	Capture current images and record live video as JPG file. Media player will view photos and playback video
HDMI IN *(Optional)	4K_3840*2160P/24/25/30fps, 2K_2560*1440P/60fps, 720x480P/60fps/720x576P/60fps, 1280x720P/25/30/50/60fps, 1920x1080P/25/30/50/60fps, 1920x1080I/50/60fps, 800x600P/60fps, 1024x768P/60fps, 1280x1024P/60fps。
HDMI output	1 channel HDMI output, supports up to 1080P
RJ45 cable TDR test	RJ45 cable TDR test and cable quality test, to test cable pair status, length, attenuation reflectivity, impedance, skew and other parameter.
24V 2A power output	Output DC24V/2A power to camera
12V 3A power output	Output DC12V/3A power to camera
USB 5V power output	5V 2A power output
PoE power output	48V PoE power output, Max power 25.5W
Screen management	Under normal mode, you can change icons sequence and self-define the number of icons in each page
Theme	Self-define icons, desktop and application interface background, modify interface sliding effect.
drop-down menu	PoE power switch, IP setting, WLAN switch, HDMI IN functions etc screen lock, password lock screen or pattern lock
Audio test	1 ch audio signal input and 1 ch audio signal output to connect headphones

PTZ control	SupportRS485 control, Baud 600-115200bps, Compatible with more than 30 protocols such as PELCO-D/P, Samsung, Panasonic, Lilin, Yaan, etc
Color bar generator	Output one channel PAL/NTSC color bar video signal for testing monitor or video cable.(red, green, blue, white and black color)
UTP Cable tester	Test UTP cable connection status and display on the screen. Read the number on the screen
Data monitor	Captures and analyzes the command data from controlling device, also can send hexadecimal
NET TOOL PRO	NET TOOL PRO-Cable Test, Wireless Tool, Link Tool, Full Duplex Detection, PING, IP Scan, DHCP Server, PPPOE, OUI Search, Socket Tool, DNS, LLLDP.
Cable tracer* (Optional)	Using the advanced multiplexing technique, the cable tracer and cable test in the same interface. Find a connected cable from a bundle of cables using audio tones
PoE /PSE voltage test	Measures PoE switch voltage and displays pin configuration
Digital Multi-meter *(Optional)	AC/DC Voltage, AC/DC current, Resistance, Capacitance, Data hold, Relative measurement, Continuity testing. Testing speed: 3 times/ seconds, Data range -6600~+6600.
Optical power meter *(Optional)	Calibrated Wavelength(nm): 850/1300/1310/1490/1550/1625nm Power range(dBm): -70~+10dBm
Visual fault locator *(Optional)	Test fiber's bending and breakage (SM and MM fiber)
TDR cable test *(Optional)	BNC cable, network cable, telephone cable, RVV cable and elevator cable, cat 5/6 cable's length and short circuit. measurement range 1.2KM
BNC attenuation test *(Optional)	Through hardware high-speed sampling and processing technology, test the BNC coaxial cable transmission attenuation value, detect the transmission quality of BNC cable.
POWER	

External power supply	DC 12V 2A
Battery	Built-in 7.6V Lithium polymer battery, 7800 mAh
Rechargeable	Fasting charge, after charging 3.5 hours, normal working time 16 hours
Parameter	
Operation setting	Capacitive touch screen, OSD menu, select your desired language: English, Chinese, Polish, Italian, Korean, Russian, Spanish, Japanese, French, German, Turkish, Portuguese, Vietnamese, etc.
Auto off	1-30 (mins)
General	
Working Temperature	-10°C --- +50°C (14°F --- 122°F)
Working Humidity	30%-90%
Dimension/Weight	240mm x 154mm x 46mm / 620g

4.2 Multi-meter specifications

Counts: -6600~+6600

Conversion rate: 3times/s

Current modes for clamp meter with ZERO function

Isolation: the Multi-meter connector must be isolated with the other connector.

DC voltage

Range	Accuracy	Resolution
660mV (Manual range)	$\pm (0.3\%+4)$	0.1mV
6.600V		1mV
66.00V		10mV

660.0V		100mV
--------	--	-------

AC voltage

Range	Accuracy	Resolution
660.0mV (Manual range)	$\pm (1.5\%+6)$	0.1mV
6.600V	$\pm (0.8\%+6)$	1mV
66.00V		10mV
660.0V		100mV

DC current

Range	Accuracy	Resolution
6.600mA	$\pm (0.5\%+3)$	1uA
66.00mA		10uA
660.0mA		100uA
10.00A	$\pm (1\%+5)$	10mA

AC current

Range	Accuracy	Resolution
6.600mA	$\pm (0.5\%+3)$	1uA
66.00mA		10uA
660.0mA		100uA
10.00A	$\pm (1\%+5)$	10mA

Resistance

Range	Accuracy	Resolution
660.0 Ω	$\pm (0.8\%+5)$	0.1 Ω
6.600K Ω	$\pm (0.8\%+2)$	1 Ω
66.00K Ω		10 Ω

660.0K Ω		100 Ω
6.600M Ω		1K Ω
66M Ω	$\pm (1.2\%+5)$	10K Ω

») Continuity

Range	Resolution	Function
660.0 Ω	0.1 Ω	The measurement value less 30 Ω \pm 3 Ω ,the tester will sound

Diode

Range	Resolution	Function
2.0V	1mV	Schottky diode:0.15~0.25V rectifier diode:0.6~1.0V triode PN junction:0.5~0.8V

Capacitance

Range	Accuracy	Resolution
6.600nF	$\pm (0.5\%+20)$	1pF
66.00nF	$\pm (3.5\%+8)$	10pF
660.0nF		100pF
6.600 μ F		1nF
66.00 μ F		10nF
660.0 μ F	$\pm (5\%+8)$	100nF
6.600mF		1 μ F
66.00mF		10 μ F

4.3 Optical power meter specifications

Measure Range(dBm)	-70 ~ +10dBm
Wavelength(nm)	850nm,1300nm,1310nm,1490nm,1550nm,1625nm
Detector	InGaAs
Uncertainly	<±3%dB(-10dBm,22°C) <±5%dB(full range,22°C)
Display Resolution	Linear:0.1% ; Nonlinear:0.01dBm
Operating Temperature(°C)	-10~+50
Storage Temperature (°C)	-20~+70
Connector type	FC/PC

4.4 Visual fault locator specifications

Laser type	LD
Wavelength Calibration	650nm
Output power	5mW (Optional 10mW,20mW)
Modulation mode	CW/1Hz/2Hz
Measurement Range	5KM (Optional 10-20KM)
Connector	FC/PC exchangeable
Working Temperature	-10°C~+50°C
Operating Temperature	-20°C~+70°C

The data above is only for reference and any change of them will not be informed in advance. For more detailed technical inquiries, please feel free to call the Technical Department of our company.

5 . Contact us

The data above is only for reference and any change of them will not be informed in advance.

You can get more information and support by:

Website: www.rsrteng.com

Sales department: sales@rsrteng.com

After-sales service department: service@rsrteng.com

WhatsApp: +86 18100275797

Tel: +86-755-32974680

Thank you!