

***insē***

Please do not hesitate to contact us whenever you want,  
we are always more than happy to help you!

✉ support@inselife.com  
🌐 www.inselife.com



bit.ly/inse-v120-y2b  
Installation Videos V120



General Tips, FAQ, etc  
www.inselife.com

**FC**



**MADE IN CHINA**

***insē***

# USER MANUAL

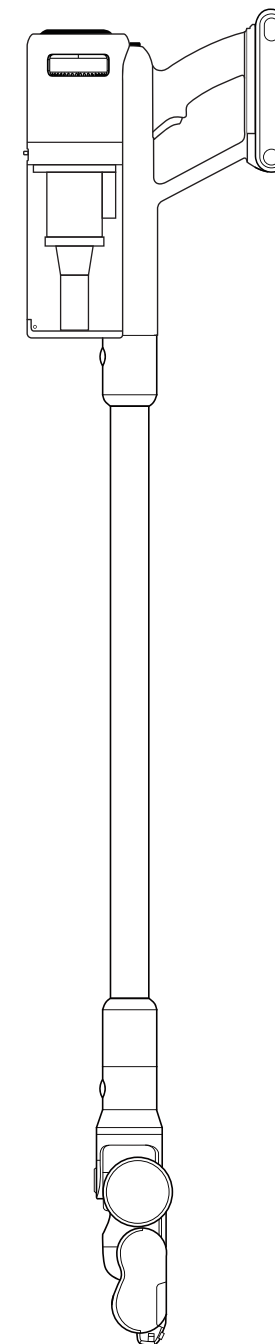

**Cordless Vacuum Cleaner  
V120**

**V120S/V120P/V121/V122  
V125/V126/V127/V128/V129**



# Contents

---

SAFETY INSTRUCTIONS & WARNINGS .....	EN 01-02
Warranty .....	EN 03
Product Parts List and Schematic .....	EN 04
Product Overview .....	EN 05
Specifications .....	EN 06
Charging Notes .....	EN 06
Storage .....	EN 07-08
Assembly .....	EN 09
Operating the Vacuum .....	EN 10
Troubleshooting & Cleaning .....	EN 11-16
When the LED shows  .....	EN 11
Detach the Dust Cup .....	EN 12
Install the Dust Cup .....	EN 12
Cleaning the HEPA Filter .....	EN 13-14
When the LED shows  .....	EN 15
Cleaning the Brush Roll .....	EN 15
Basic Troubleshooting Guide .....	EN 16

## SAFETY INSTRUCTIONS & WARNINGS

---

### SAFETY INSTRUCTIONS

- Before using this product, read all instructions and warnings in this manual and on the product.
- When using an electrical appliance, you should always follow basic precautions to reduce the risks of fire, electric shock, and injury.

### WARNINGS

1. This vacuum cleaner is for household use only. Do not use it for commercial cleaning or other purposes of cleaning.
2. Before connecting the product to the power supply, make sure the local voltage is the same as the voltage indicated on the power adapter.
3. Before use, be sure to check the product. If the product or power adapter is damaged, stop using it.
4. Please use the product in strict compliance with the instructions of this manual. It is strictly prohibited to perform any maintenance operations other than those recommended by the company's after-sales personnel.
5. This product is not intended for use by children or persons with decreased physical, sensory or reasoning capabilities, or lack of experience and knowledge unless the guardian is around to supervise or give instructions to ensure their safe use of the product.
6. Keep this product away from children. Keep a close eye on your children, and do not let them use this product as a toy.
7. Keep the vacuum cleaner away from fire and other hot places.
8. Do not use or store the machine under extremely adverse conditions, such as extreme temperatures. It is recommended that you use it in an indoor environment with an ambient temperature of 5 °C to 40 °C. Store it in a cool and dry place, and do not expose it to sunlight for a long time.
9. Please fully charge the battery before using the new battery or using the battery for the first time after long storage.
10. Do not touch the plug or any part of the product with wet hands.
11. If the power supply cord is damaged, it must be replaced by a professional from the manufacturer, its maintenance department, or other similar departments to prevent danger. Dismantling or replacing parts on your own may cause an electric shock or fire, for which the company will not be liable.
12. Be sure to use the original power adapter to charge this product.
13. Be sure to use the original battery: other types of batteries may burst, resulting in personal injury or product damage.

## SAFETY INSTRUCTIONS & WARNINGS

---

14. If the product is not working as it should according to the instructions of the manual, has received a severe impact, fallen from a height, been damaged, or fallen into the water, do not use it and please contact the after-sales service personnel.
15. Only the specified replacements and parts can be used; otherwise, the company will not be liable.
16. If the power adapter cable or plug is damaged, do not use it. Once the cable is damaged, it must be replaced by the company, service agents, or personnel with relevant qualifications to prevent harm.
17. Do not use this product to suction water.
18. Do not use the vacuum cleaner to suction flammable or explosive liquids such as gasoline, or use the machine where these liquids or their vapors may exist.
19. Do not use this vacuum cleaner to suction burning or smoke objects, such as cigarette butts, matches, or hot ashes.
20. Do not insert anything into product gaps. Do not use it when any air channel is sealed. Remove any dust, cotton wool, hair, or anything that could hinder airflow.
21. Do not use it before the clear bin and HEPA are installed in place.
22. Disconnect the power supply or unplug the machine during repair, cleaning, and maintenance, and before replacing the HEPA.
23. Take special care when using the product to clean stairs.
24. Do not install, charge, or use this product outdoors, in the bathroom, or within 3 meters (10 feet) of a swimming pool. Do not use it on wet surfaces, and keep it free from moisture, rain, and snow.
25. When cleaning the vacuum cleaner, use a dry cloth. Do not use gasoline, alcohol, banana oil, etc. Otherwise, the shell will crack or fade.
26. When storage for a long time, ensure that the battery power is sufficient and that the battery is charged and discharged at least once every three months.
27. Fire hazard warning - Do not place this product on or near a stove or any other high-temperature surface, and do not incinerate it even if it is severely damaged. The battery may catch fire or explode.
28. Fire hazard warning - Do not apply any fragrance product to the filter of this product. The chemicals in this type of product are known to be inflammable and can cause the product to catch fire.

## SAFETY INSTRUCTIONS & WARNINGS

### Warranty

#### 12-month Warranty & Lifetime Customer Support

Only apply to eligible purchases made directly from INSE Authorized Retailers. Warranty coverage applies to the original owner and to the original product only and is not transferable.

#### What is Covered:

- Unless otherwise stipulated by law, we will repair or replace the product for you if material, manufacturing, or functional defects are found within 1 year after purchase (at our discretion, if any part is no longer available, we will replace it with a replacement part that is functionally equivalent).
- This warranty is valid only when the product is used in the country where it was sold.
- You must provide proof of purchase. Otherwise, any work carried out will be chargeable. Please keep your receipt or invoice properly.

Type	Warranty Content	Warranty Period
Main Machine	Main Machine	1 Year
Battery/Power Adapter	Battery/Power Adapter	1 Year
Accessories	Motorized Floor Brush Metal Tube 2-in-1 Brush	1 Year

#### What is Not Covered:

- Accidental damage and faults caused by negligent, incorrect, careless, or improper operations or any other manner in violation of the instructions of the user manual;
- Use of the product for any purpose other than normal household use;
- Repairs or alterations carried out by parties other than the company or its authorized agents;
- Normal wear and tear (e.g. product appearance, fuse, brush bar, etc);
- Use of the product for gravel, ash, or plaster;

If you have any doubt about what is covered, please contact the customer service personnel of your purchase channel.

## Product Parts List and Schematic

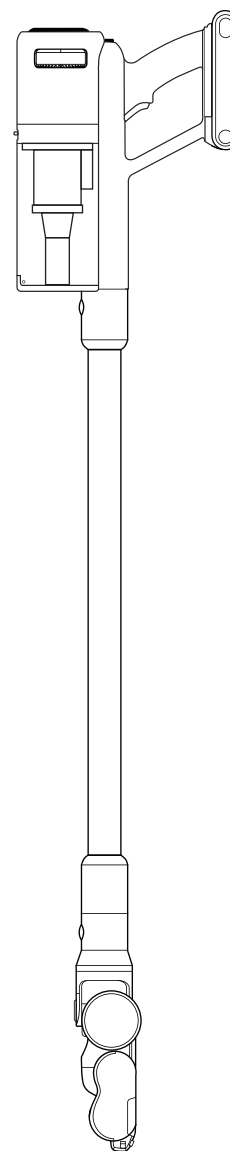

Main Motor

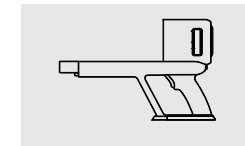

Motorized Floor Brush

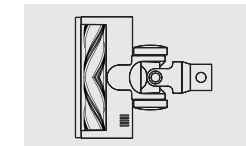

Battery Pack

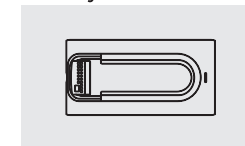

Power Adapter

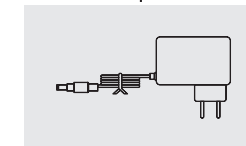

Dust Box

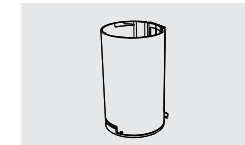

Wall Mount

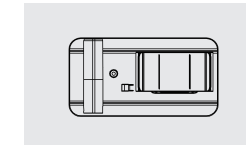

Metal Tube

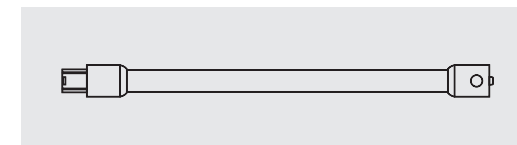

2-in-1 Brush

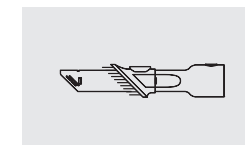

HEPA Filter

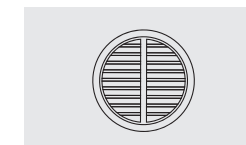

Metal Strainer

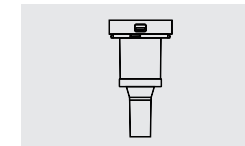

2-in-1 Cleaning Gadget



User Manual



Quick-start Guide

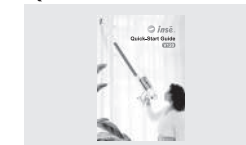

## Product Overview

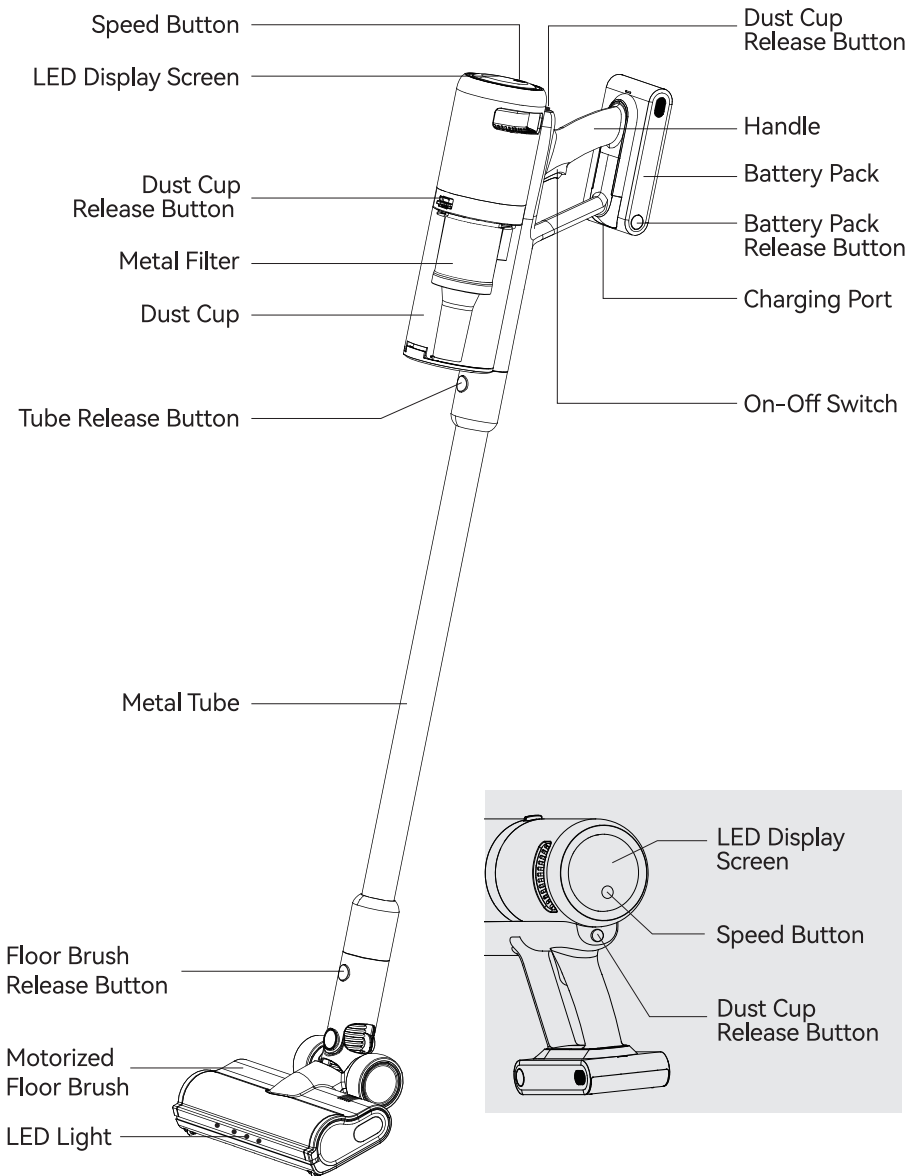

Due to the continuous optimization and improvement of this product, the above accessories may vary according to different versions. The company has the right to final interpretation.

## Specifications

Model	V120
Rated power	450W
Rated Voltage	25.9V $\approx$
Power Adapter Input	100-240V~50/60Hz
Power Adapter Output	32V $\approx$ 800mA
Battery Capacity	2500mAh
Charging Time	3.5~4 hour
Product Net Weight	2.7Kg
Product Weight (All Attachments)	3.0Kg

## Charging Notes

Before first use, please fully charge the appliance (3.5~4 hours)

1. For the purpose of recharging the battery, only use the supply unit matched with this appliance. Other types of chargers can cause battery failure or extreme thermal effects.
2. While charging, please put the product upright on the storage base, and put them against the wall to avoid stumbling.
3. Normally, it takes about 3.5~4 hours for the vacuum to be fully charged.
4. Unplug the adapter after charging is finished.
5. Please keep the adapter away from water.

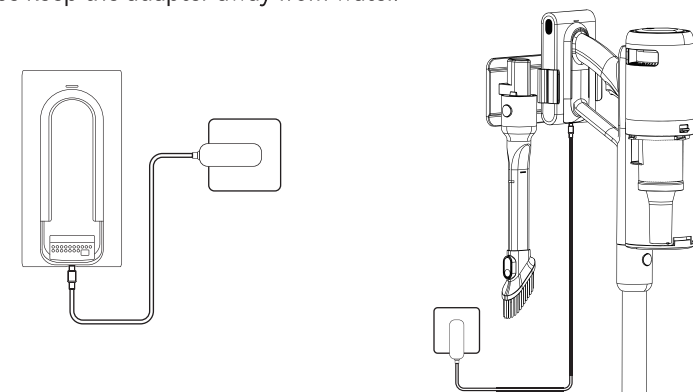

During charging, the white LED is continuously blinking. If the white LED becomes steady on, it means that the device has been fully charged. The charging duration is about 3.5 hours.

## Storage

### Wall Mount Installation Guide

1. First, install the wall mount firmly on the wall. Before fix the included wall mount, please make sure to place it high enough but without hanging the machine off the ground so that the vacuum can be securely mounted.
2. Then please insert the vacuum cleaner holder clip into the U-shaped groove from top to bottom.
3. Finally, please insert the 2-in-1 brush storage clip from top to bottom and put it into the square groove to fix it.
4. In the middle of the vacuum cleaner holder clip and the 2-in-1 brush storage clip is the adapter wire storage groove.

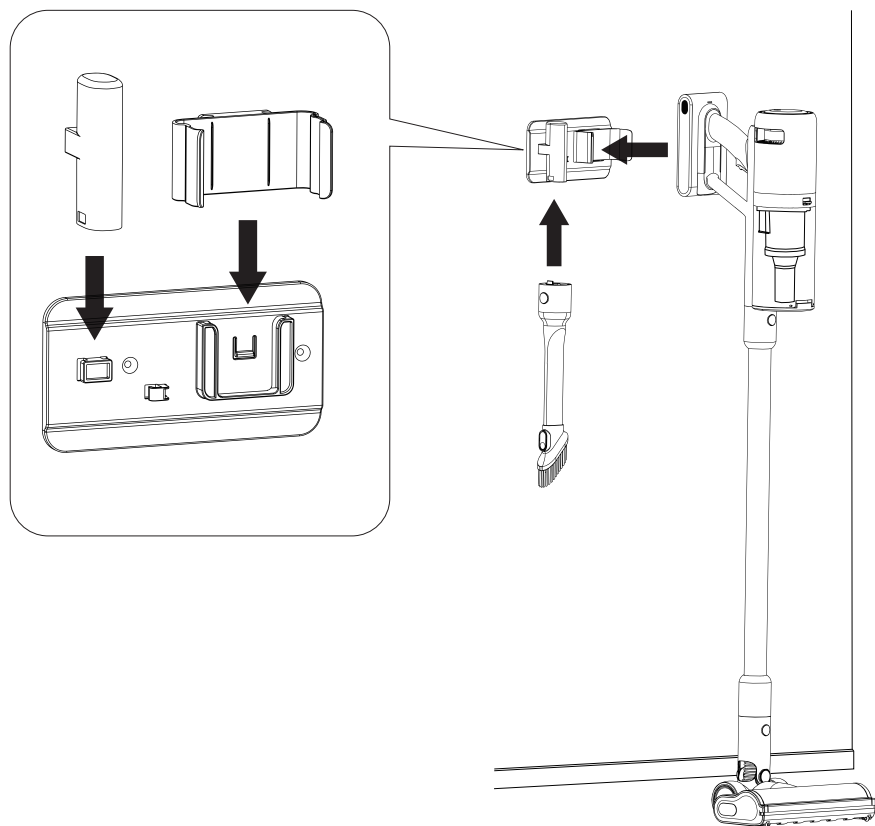

## Storage

### Method 1

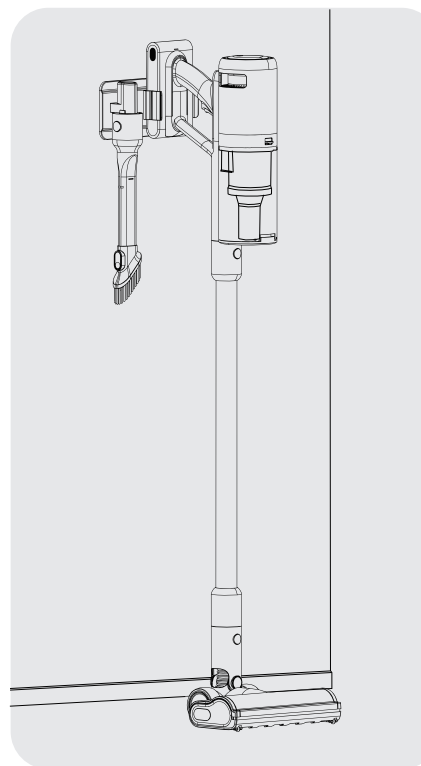

### Method 2

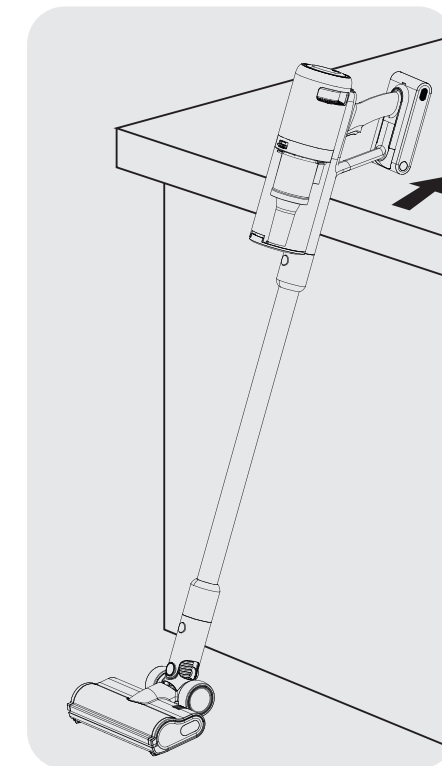

## Assembly

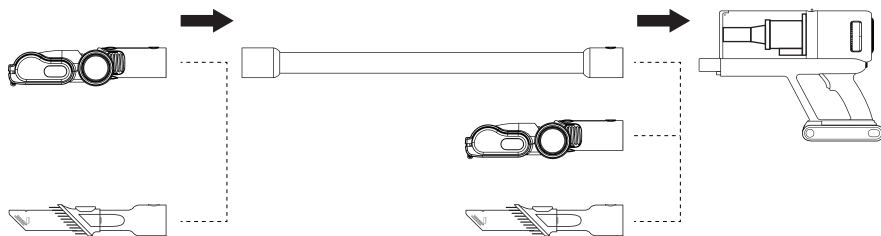

1

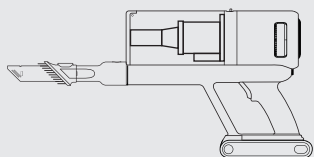

2

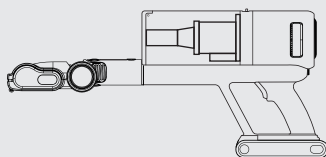

3

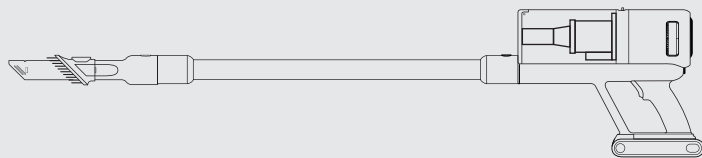

4

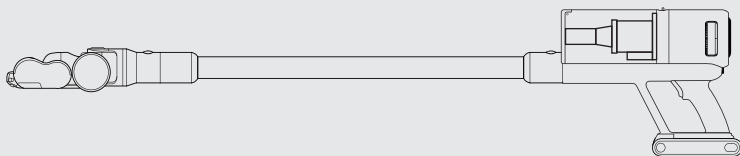

## Operating the Vacuum

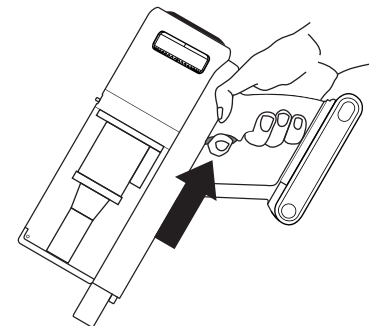

### ON/OFF

Press the trigger, and the device will start vacuum-cleaning. You do not need to hold down the trigger. Press it again, and the device will stop vacuum-cleaning.

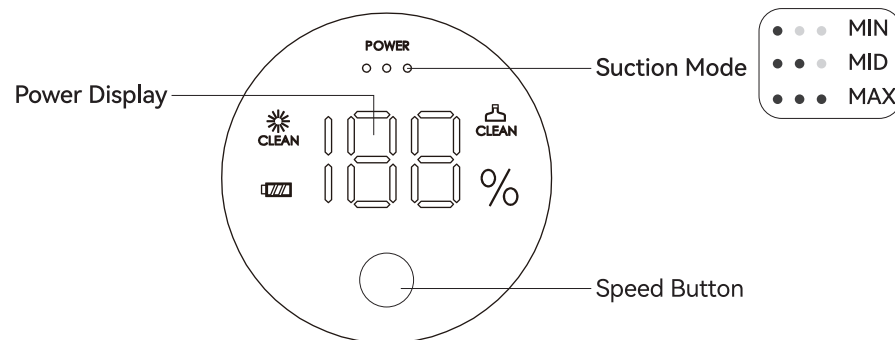

### Speed Button

Tap the red button on the screen to adjust the suction force. 3 gears are supported: **MAX**, **MID**, and **MIN**.

\* If you do not adjust the suction force before starting the vacuum cleaner, the medium gear is used by default.

## Troubleshooting & Cleaning

### When the LED shows

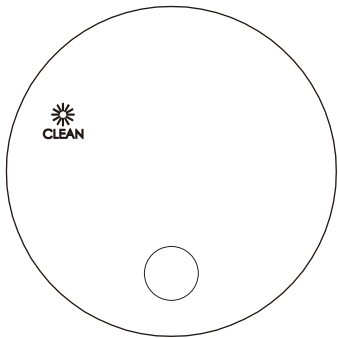

If the display screen shows this red icon, you need to check the dust cup and connection tube to see whether they are blocked and whether the HEPA has retained too much dust.

If the dust cup has too much trash, Please clean the cup first. Remove the connecting tube, point it towards a trashcan, and push forward the button above the handle with your thumb to open the cover and dump the dust.

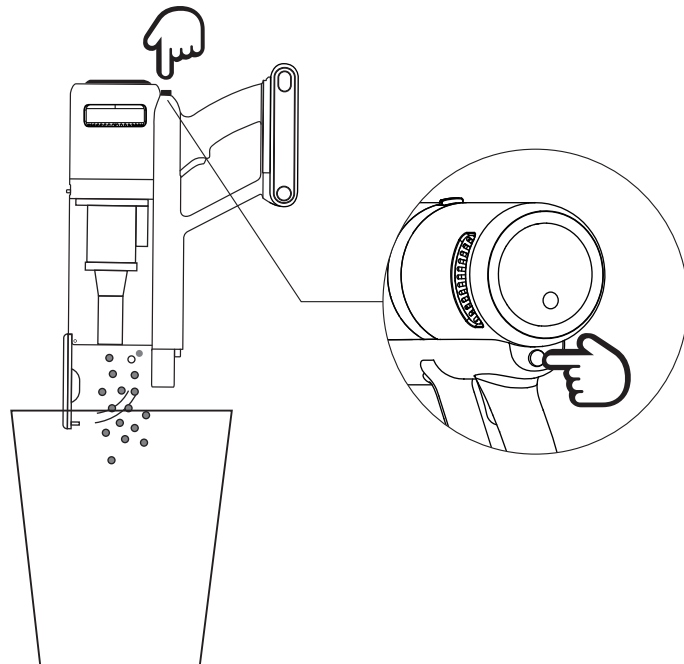

## Troubleshooting & Cleaning

### Detach the Dust Cup

1. Firstly, please press the metal tube release button to detach the motor head and the metal tube.
2. Then follow the down arrow marked on the motor head to press the dust cup release switch and detach it.

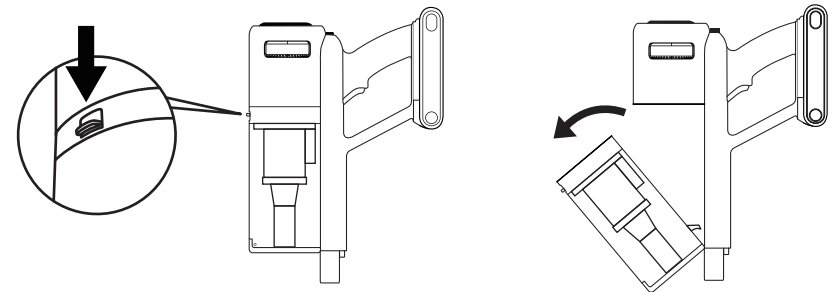

### Install the Dust Cup

Please insert the two hooks on the back of the dust cup into the two grooves of the main motor first, and then gently push inward to install the dust cup.

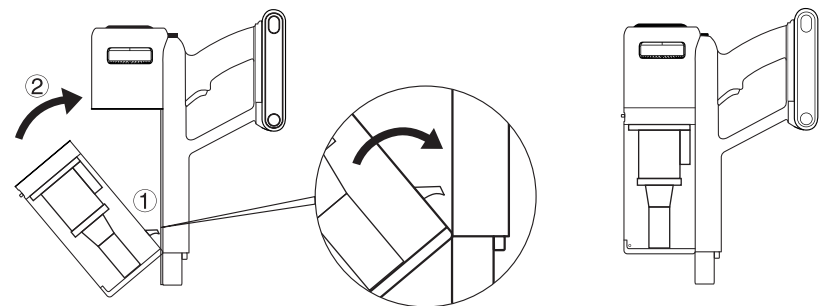



## Troubleshooting & Cleaning

### Cleaning the HEPA Filter

Press down the unlock button on the top of the dust cup to lift the dust cup upward.

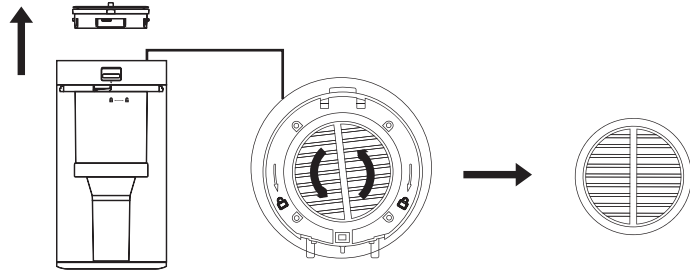

If there is too much dust on the HEPA, please clean it up in time.  
Turn the HEPA counterclockwise 15° to take it out.

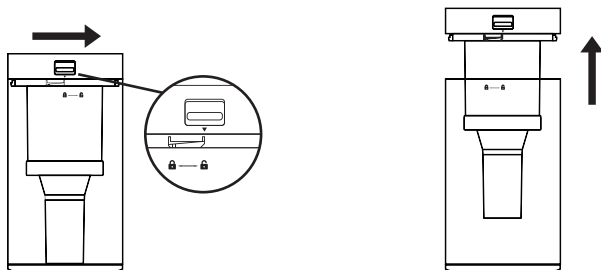

Turn the cyclone cone until the triangle symbol ▼ is pointed at the unlock symbol 🔒, and then the cyclone cone and clear bin can be separated.

## Troubleshooting & Cleaning

If there is too much dust on the strainer, please clean it up in time.  
The 3 assemblies below can be cleaned with water. Air-dry them completely before reinstalling them for use!

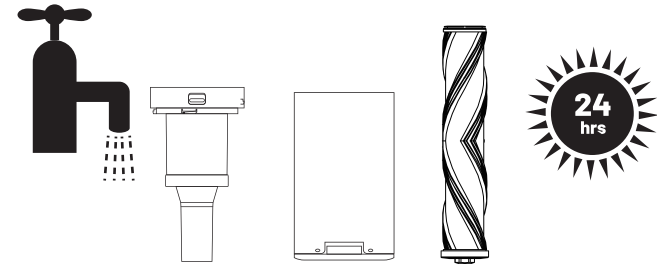

To reduce suction loss, we recommend that you clean the above assemblies at least once every month.



HEPA  
Unwashable

\* Regularly replace the HEPA filter to prevent the suction decline from affecting machine cleaning performance.

## Troubleshooting & Cleaning

### When the LED shows

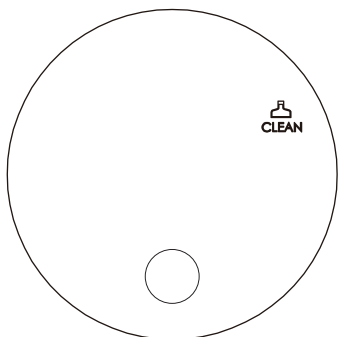

If the display screen shows this red icon, you need to check whether the floor brush is entangled by hair.

### Cleaning the Brush Roll

After flipping the bottom switch of the floor brush to the unlock icon, you can lift the locking piece to take out the rolling brush.

If the rolling brush is entangled by hair, clean it up in time.

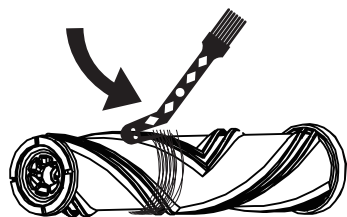
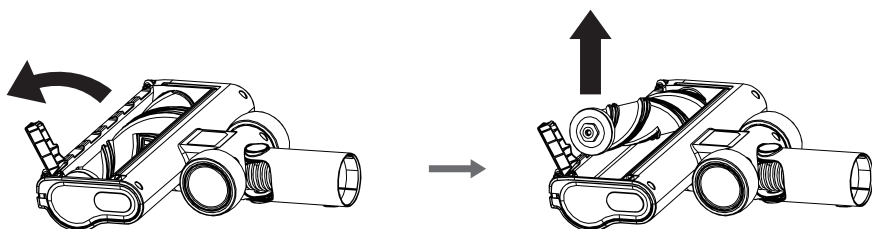

## Troubleshooting & Cleaning

### Basic Troubleshooting Guide

Problem	Possible Cause	Possible Solution
Not working	Battery pack not installed correctly	Reinstall battery pack
	Low battery	Fully charge the battery
	Roller tangled	Clean the roller
	Dust box reaches max volume	Clean dust box
Poor suction	Dust box reaches max volume	Clean dust box
	Dust box not installed correctly	Reinstall dust box
	Roller tangled	Clean the roller
	Air duct blocked	Clean air duct
	Low battery	Fully charge the battery
	Dirty HEPA didn't work	Clean or replace the HEPA
Abnormal sound in motor	Filter strainer blocked	Clean the filter strainer
	Air duct blocked	Clean air duct
	Dust box reaches max volume	Clean dust box
Not charging	Dirty HEPA didn't work	Clean or replace the HEPA
	Plug isn't well connected	Make sure the plug is well connected