

insē



Please do not hesitate to contact us whenever you want, we are always more than happy to help you!

✉ support@inselife.com

🌐 www.inselife.com

FC



MADE IN CHINA

insē

USER MANUAL

Cordless Stick Vacuum Cleaner

**S10 / S11 / S12 / S15 / S16 /
S17 / S18 / S19 / S10P / S10X /
S10P Rro / S100 / S150 / S160 /
S170 / S180 / S190**

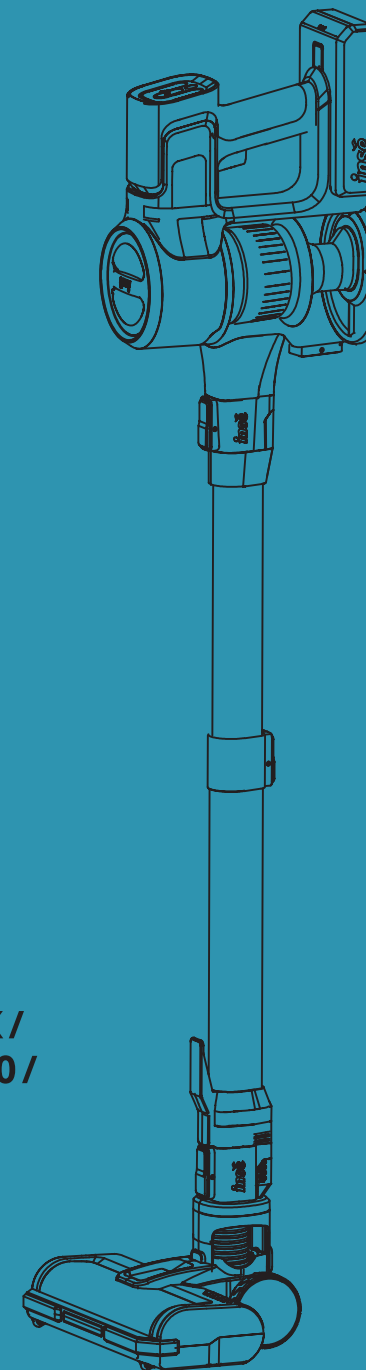

Warranty

NOTE:
THIS WARRANTY TERM GIVES YOU SPECIFIC LEGAL RIGHTS, AND YOU MAY ALSO HAVE OTHER RIGHTS WHICH VARY FROM STATE TO STATE.

12-month Warranty & Lifetime Customer Support

Only apply to eligible purchases made directly from the INSE authorized distributors. Warranty coverage applies to the original owner and to the original product only and is not transferable.

How to initiate a warranty claim

If your appliance operates improperly while in use under normal household conditions within the warranty period, please contact our customer support [support@inselife.com] or visit www.inselife.com to fill out the warranty form to initiate a warranty claim.

For more warranty details, please refer to www.inselife.com.

All rights are reserved by INSE official website.

Ready to Use Your Vacuum Cleaner?

Please read the attached user manual carefully before use.

Besides, you could get more operation guidance and maintenance tips on **INSE S10 Support**:



<https://bit.ly/inse-s10-support>
Maintaince tips, Installation vedios etc.

INSE CUSTOMER CARE

Your INSE vacuum cleaner enjoys a 12-month warranty. It will be covered for all accessories for 12-month from the date of purchase. If you have any questions about your INSE appliance, just contact INSE Customer Support via the following channels:

You can reach the INSE customer support team at
Email: support@inselife.com with your order ID,
and details of the issue you met.

INSE Customer Support will help you solve the problem quickly within 24 hours.

CONTENTS

Important Safety Instructions	01
Battery safety	02
Warning	03
Product Parts List and Schematic	04
Accessory Instructions	05
Product Overview	06
Assembly and Storage	07
Combination	08
Ready to Use	09
Charging	10-11
Product Technical Parameters	12
Daily Maintenance	13-14
Trouble Shooting	15

IMPORTANT SAFETY INSTRUCTIONS

BEFORE USING THIS MACHINE READ ALL INSTRUCTIONS AND CAUTIONARY MARKINGS IN THIS MANUAL AND ON THE MACHINE

When using an electrical appliance, basic precautions should always be followed, including the following:



Do not use near open flames

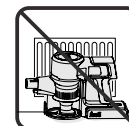

Do not store near heat sources



Do not pick up water or liquids



Do not pick up burning objects



Do not put hands near the brush bar when the machine is in use

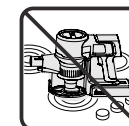

Do not place on or near the cooker

- Do not use to pick up water or any other liquid, as this may cause electric shock.
- Do not use to pick up sharp objects such as glass or screws, etc.
- Do not use the appliance to pick up flammable liquid, matches, cigarette ends, hot ashes or any hot, burning or smoking objects.
- Do not use if any of its openings are blocked.
- Do not store the appliance in direct sunlight or in high humidity conditions.
- Do not use this appliance outdoors.
- Do not use any damaged accessories or adaptors.
- Do not use any parts/accessories or adaptors other than those supplied with this appliance, as this may cause damage.
- Do not use the appliance for anything other than its intended use.
- Do not use the appliance if it has been dropped or if there are visible signs of damage.
- Do not use the adaptor to recharge non-rechargeable batteries.
- Do not remove from the adaptor from the mains power supply by pulling the cord; switch off and remove the plug by hand.
- Do not expose the appliance to rain.
- Do not operate the appliance with wet hands.
- Do not immerse the appliance in water or any other liquid.
- Only use with provided power adapter.
- Use of an extension power cord is not allowed.
- Always ensure that the appliance has cooled fully after use before performing any cleaning or user maintenance.
- Switch off the appliance and disconnect it from the mains power supply before changing or fitting accessories.
- Take care when equipping accessories with rotating parts as this could cause entrapment.
- This appliance is intended for domestic use only. It should not be used for commercial purposes.

- Keep the appliance away from other heat emitting appliances.
- Keep the appliance away from heat or sharp edges that could cause damage.
- Keep away from children aged below 8.
- Improper repairs may put the user in danger.
- If any part is damaged due to human error, only a qualified electrician can repair it. Please note the appliance is not under warranty in this case.
- This appliance is not a toy.
- Children should be supervised to ensure that they do not play with the appliance.
- Children whose aged from 8 years and above, people who with reduced physical, sensory or mental capabilities or lack of experience and knowledge can use this appliance, only if they have been given supervision or instruction concerning to use the appliance in a safe way and understand the hazards involved.
- Check the voltage indicated on the rating plate and confirm you connect the appliance to the power supply with correct voltage.

Battery Safety

- If the battery pack becomes exhausted, it should be removed from the product to avoid leakage.
- In the event of the battery pack leaking, do not allow any liquid to come into contact with the skin or eyes.
- If contact has been made, wash the affected area with copious amounts of water and seek medical advice.
- Keep the battery pack out of the reach of children.
- Secondary battery packs need to be charged before use. After extended periods of storage, it may be necessary to charge and discharge the batteries several times to obtain maximum performance.
- Do not leave battery packs on charge for prolonged periods of time.
- Do not use any charger other than that specifically provided for use with the product.
- The supply terminals are not to be short-circuited.
- Do not store above 60°C. Avoid storing in direct sunlight.
- Do not use any battery packs that are not designed for use with the product.
- Do not dispose of the battery pack in a fire.
- Do not crush, puncture, dismantle or otherwise damage the battery pack.
- Do not dismantle, open or shred battery packs.
- Do not expose the battery pack to heat or fire as it may explode.
- Do not subject the battery pack to mechanical shock.
- Do not dispose of the exhausted battery pack in household waste.
- To dispose of the exhausted battery pack, take it to a local recycling station.
- Contact the local government offices for further details.
- This appliance is fitted with a 25.2V 2200mAh Li-ion rechargeable battery.

WARNING

Read all safety warnings and instructions. Failure to follow the warnings and instructions may result in electric shock, fire and/or serious injury.

1. Prevent unintentional starting ensure the switch is in the off-position before connecting pack, picking up, or carrying the appliance.
Carrying the appliance with your finger on the switch or energizing appliance that have the switch on invites accidents.
2. Disconnect the battery pack from the appliance before making any adjustments changing accessories or storing appliance.
Such preventive safety measures reduce the risk of starting the appliance accidentally.
3. Recharge only with the charger specified by the manufacturer. A charger that is suitable for one type of battery pack may create a risk of fire when used with another battery pack.
4. Use appliances only with specifically designated battery packs.
Use of any other battery packs may create a risk of injury and fire.
5. When battery pack is not in use, keep it away from other metal objects, like paper clips, coins, keys, nails, screws or other small metal objects, that can make a connection from one terminal to another.
Shorting the battery terminals together may cause burns or a fire.
6. Under abusive conditions, liquid maybe ejected from the battery; avoid contact.
If contact accidentally occurs, flush with water.
If liquid contacts eyes, additionally seek medical help.
Liquid ejected from the battery may cause irritation or burns.
7. Do not use a battery pack or appliance that is damaged or modified.
Damaged or modified batteries may exhibit unpredictable behavior resulting in fire, explosion or risk of injury.
8. Do not expose a battery pack or appliance to fire or excessive temperature.
Exposure to fire or temperature above 130°C may cause explosion.
The temperature of 130°C can be replaced by the temperature of 265 °F.
9. Follow all charging instructions and do not charge the battery pack or appliance outside of the temperature range specified in the instructions.
Charging improperly or at temperatures outside of the specified range may damage the battery and increase the risk of fire.
10. Have servicing performed by a qualified repair person using only identical replacement parts.
This will ensure that the safety of the product is maintained.
11. Do not modify or attempt to repair the appliance or the battery pack (as applicable) except as indicated in the instructions for use and care.

Product Parts List and Schematic

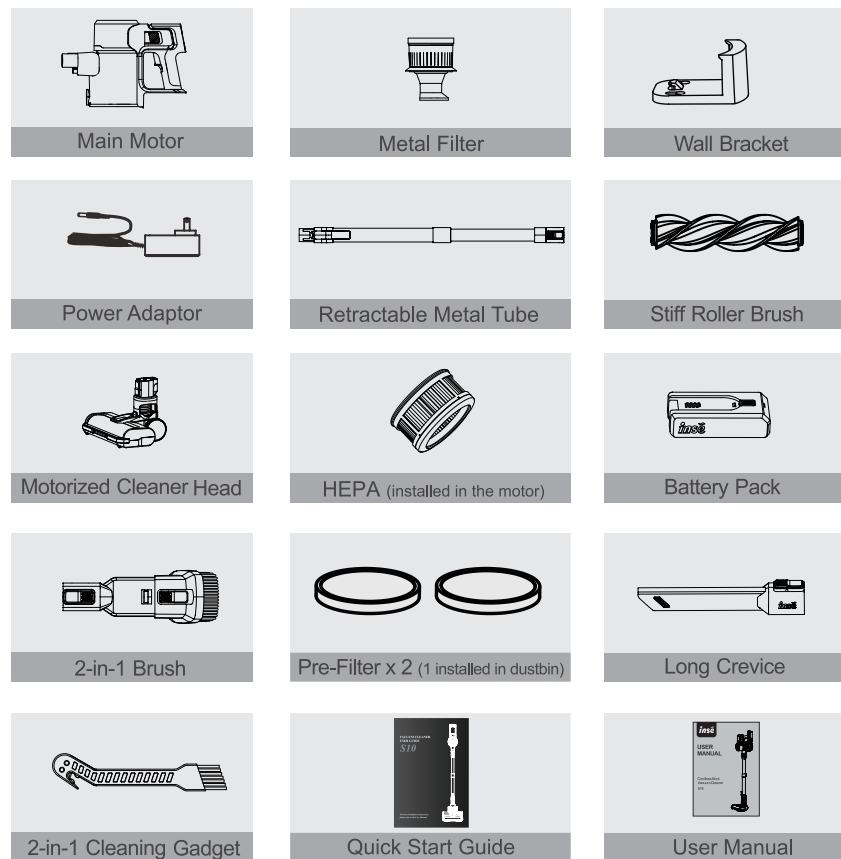

- * Actual accessories may vary from shown or change without notice.
- * Available accessories may vary by market.

Accessory Instructions

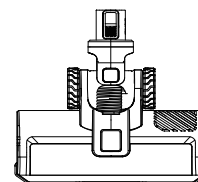

Motorized Cleaner Head

Can be connected to the metal tube for daily cleaning on the floor or carpet, or to the main motor for cleaning the trunk



Stiff Roller Brush

Can be installed into the cleaner head; Ideal for both hard floors and carpets

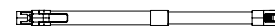

Retractable Metal Tube

Can be installed into the cleaner head; performs better for corners that are not easy to clean up

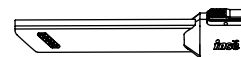

Long Crevice

For corners and other hard-to-reach places; can be connected to the metal tube to clean spider web on the ceiling

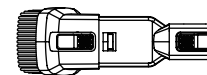

2-in-1 Brush

Can be switched into a brush or a wide crevice; suitable for fabric surface and corners



2-in-1 Cleaning Gadget

The blade end can be used to cut off hair that wrapped around roller brush, the another brush end can be used to clean dirt inside dustbin, strainer or cleaner head

Product Overview

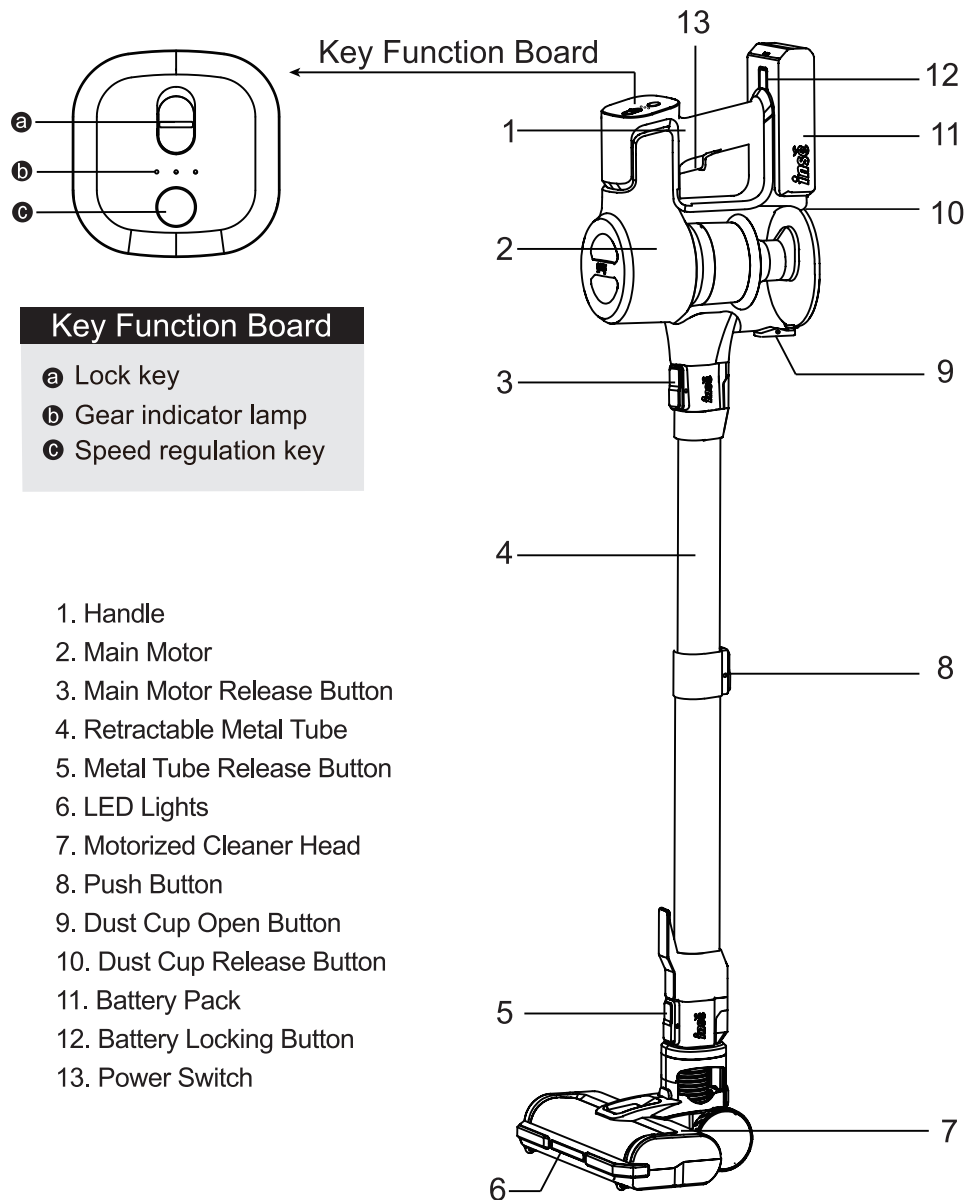

Assembly and Storage

1. Insert the tube end into the cleaner head port until you hear a click, make sure the connection is tight. And press the metal tube release button with one hand, hold the tube with another hand and then pull it out to remove it.
2. Insert the metal tube end into the suction port of the main motor until you hear a click, make sure the connection is tight. And press the main motor release button with one hand, hold the main motor with another hand and then pull the handle to remove the main motor from the tube.

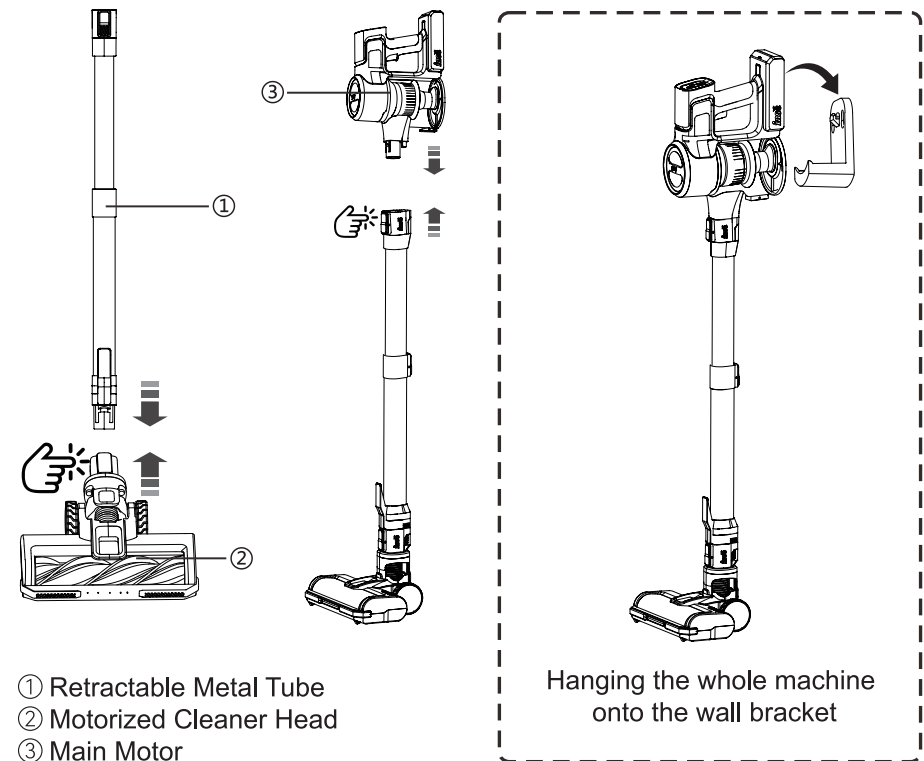

Combination

1

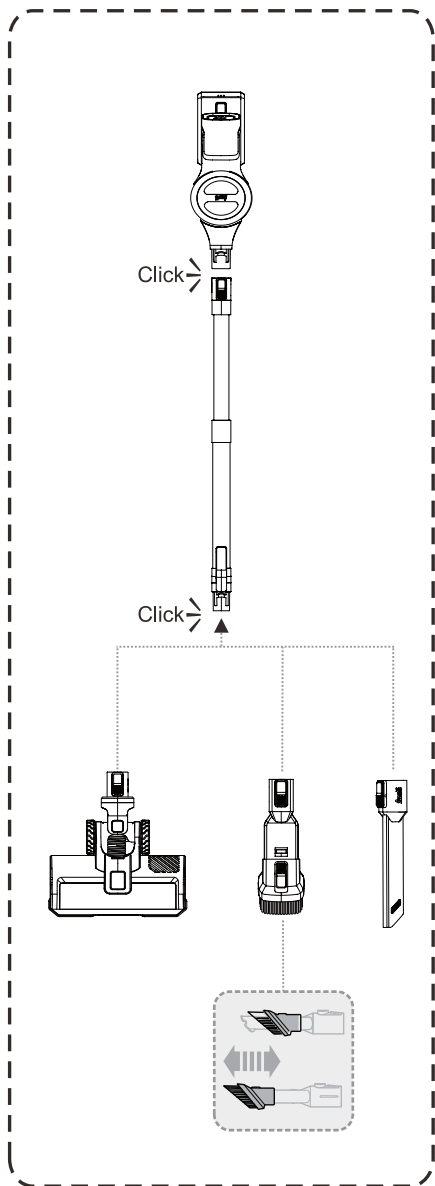

2

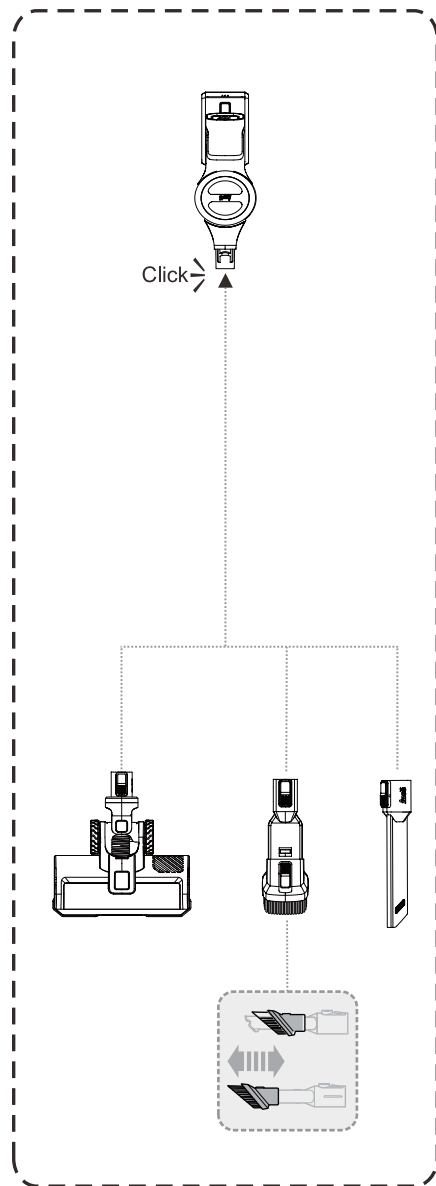

Ready to Use

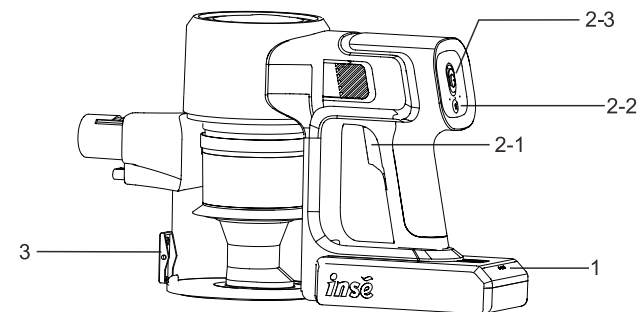

1. Preparation

Please check if the battery power is sufficient before using. It's suggested to charge over 5-6 hours before the first time of use to ensure utmost performance of the product. Choose the attachment you need according to the cleaning area/surface.

2. Start to Work

- 2-1 Press the power switch to turn on the vacuum, second press to turn it off.
- 2-2 Press the button to switch the power mode between MIN, MID and MAX mode.
- 2-3 Press the power switch to turn on the vacuum, push the button, release the power switch, the vacuum continues to work. Push the button again to turn the vacuum off. The button has a lock function. Push it again and the lock function will be invalid.

- ⓘ **HOUSEHOLD USE ONLY**
- ⓘ **DO NOT** use outdoors or on wet surfaces
- ⓘ **DO NOT** immerse in water

3. Dust Cup Cleaning

After turning off, press the button to release the dustbin cover, dump the dirt and then close the cover until you hear a click.

Charging

- * For safety, the battery was charged up to 30% battery capacity before shipping. Please fully charge the battery before first use.
- * It takes about 4.5 hours to fully charge the battery from flat status.

Way 1: Insert the battery pack into the main motor; insert the power plug into the battery pack; connect the power adaptor with the power supply

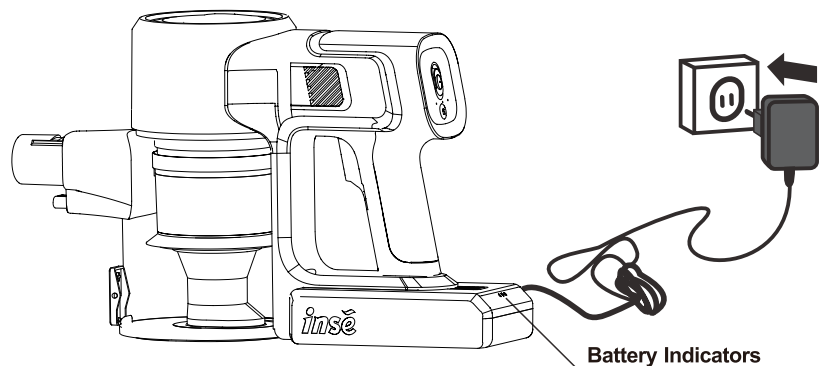

Way 2: Charge the separate battery directly

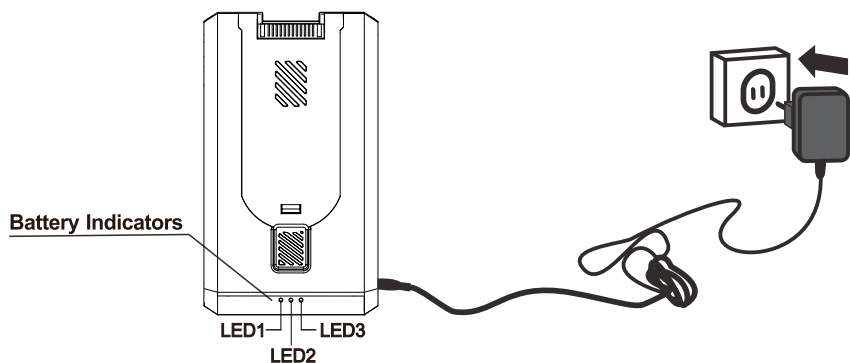

Battery Indicators

On Work

- ● ● - Three solid white lights: **full power**
- ● - Two solid white lights: **medium power**
- - One solid white light: **low power**
- ☀ - One blinking white light: **lower than 10% of the total power, needs a recharge**

During Charging

- ☀ ☀ - Three white lights blinking successively: **charging**
- ● ● - Three steady lights: **charging complete**

! Notes:

- * The machine cannot be turned on during charging
- * Charge the battery only with the adaptor (30V) provided by INSE
- * When you won't use the battery for a long time, please store it in a cool dry place. In this situation, please ensure that the battery has been half charged (2 glowing indicator lights)
- * If you need an additional battery, please purchase from an authorized distributor of INSE
- * When the Brush motor overcurrent protection or short circuit protection, the machine stops, LED1, LED2, LED3 into 3HZ running lights, 5 seconds after the extinguish, all keys fail during the alarm.
- * When the vacuum motor overcurrent protection, short circuit protection or blocking, the machine stops, LED1, LED2 and LED3 will blink synchronously at 3HZ, other lights will be off after 5 seconds, and all keys will fail during the alarm.
- * When the battery pack is abnormal, LED1 blinks at 3HZ synchronously. Other lights are off and will be off after 5 seconds. During the alarm, all keys fail. For example, when discharging, the cell temperature is higher than $70\pm 3^{\circ}\text{C}$.
- * When the voltage of the charger is $< 30\text{V}$, it can be charged normally. LED1, LED2, LED3 blink once every second, and the light sequence is from left to right. When the charger voltage is higher than 31.5V , stop charging, LED1, LED2, LED3 lights run the horse light, 5 seconds after the shutdown.

Product Technical Parameters

Product Model	S10		
Product Net Weight (Main Motor with Battery)	1.6kg/3.5lb	Rated Power	350W
Dust Cup Capacity	1L	Rated Voltage	25.2V
Charging Time	4.5 hours	Power Adapter Input	100-240V~50/60Hz
Battery Capacity	2200mAh	Power Adapter Output	30V 500mA

Power Mode and Runtime

Note:

* Any runtime posted on the website is the time when the machine runs without attaching to any surface and debris.

* Actual runtime will vary based on the power mode, battery capacity, attachment, debris amount, cleaning area/surface.

Daily Maintenance

In order to make ensure max performance of the vacuum, please regularly maintain its components.



The dustbin or the cleaner head cannot be washed by water. Otherwise, the motors will be damaged.

Clean Handheld Part of the Main Motor

- ⚠ Please turn off the vacuum before cleaning.
- ⚠ Wipe the surface with a clean cloth; avoid the water gets into the inner part of the vacuum.
- ⚠ Do not place the vacuum under direct sunlight or in wet places after cleaning.

Clean Dust Cup

The sign -MAX- on the dust cup means dust capacity limit. Once the dust approaches the sign, empty the dust cup in time. You could use the 2-in-1 cleaning gadget to clean the inside.

Clean Detachable Roller Brush

1. Unlock the side lock on the underside of cleaner head, remove the side cover and take out the roller brush.
2. Use the 2-in-1 cleaning gadget to cut and remove the tangled hair.

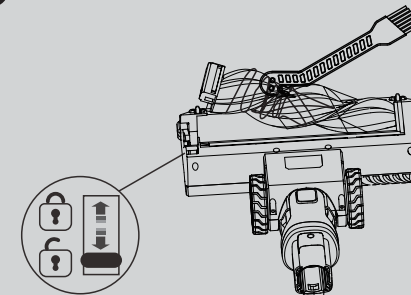

Clean Strainer and High Efficiency Filter



IMPORTANT!

1. Please check and clean the High-efficiency filter/HEPA regularly;
2. Please clean the filter in time if the suction performance decline;
3. Please replace the filter/HEPA if it's broken or it cannot maintain the suction performance of the vacuum cleaner.
4. Please do not bend or squeeze the HEPA.

1. Hold the main motor, press the button to open the dust bin cover, rotate the strainer and filter one by one to take them out. (see as pictures below)

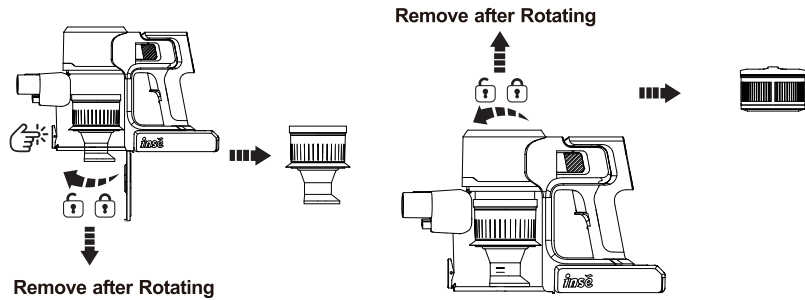

2. If they are too dirty, you could wash the metal filter and the black mesh with **cool water**, and clean the HEPA with the cleaning brush.

3. Ensure the strainer and the black mesh are **completely dry before refitting**.

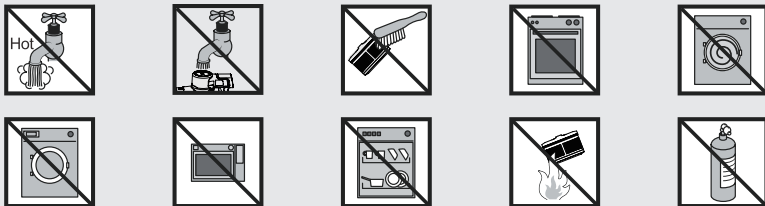
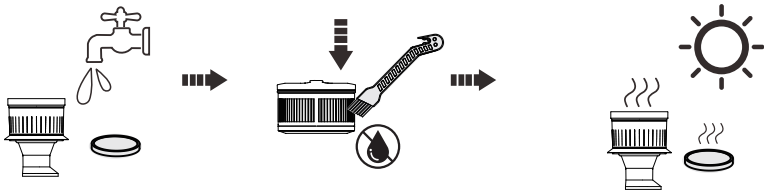

Troubleshooting

Problems	Possible Causes	Solutions
Machine stops working or doesn't work	<ol style="list-style-type: none"> 1. Low battery or no battery power 2. There is blockage 3. Roller brush is tangled by hair 	<ol style="list-style-type: none"> 1. Charge the battery 2. Remove the blockage (check the metal tube and filters) 3. Clean the roller and also remove the side covers to remove the tangled hair
Roller brush stops spinning	Roller brush is tangled by hair	Clean the roller and also remove the side covers to remove the tangled hair
Weak suction power	<ol style="list-style-type: none"> 1. Dustbin, strainer or filter is full of dust 2. The strainer or filter is not installed 3. There is blockage 4. Roller brush is tangled by hair 	<ol style="list-style-type: none"> 1. Clean the dustbin, strainer or filter, replace the filter if necessary 2. Install the strainer and filter 3. Remove the blockage
Abnormal motor sound	There is blockage	Remove the blockage
Battery cannot be charged	<ol style="list-style-type: none"> 1. Wrong adaptor is used 2. Connection between power cord and battery is loose 	<ol style="list-style-type: none"> 1. Use the correct adaptor offered by INSE 2. Make sure the power cord is plugged tightly



<https://bit.ly/inse-s10-support>
Maintenance tips, Installation videos etc.

If the solutions cannot solve the problem, or the issue you met has not been listed, please feel free to contact us via the following channels for further support:

Email: support@inselife.com

Website: www.inselife.com