

SIMDER



SD-4050PRO **10-IN-1 WELDER&CUTTER**

OPERATION'S MANUAL

Table of Contents

| | |
|---|-------|
| SAFETY | 01-05 |
| SPECIFICATION | 06 |
| TECHNICAL SPECIFICATIONS | 06 |
| OVERVIEW OF MACHINE | 07 |
| CASE FRONT & BACK CONTROLS | 07 |
| INSTALLATION | 08-11 |
| OPERATION | 12-17 |
| MIG Welding | 12 |
| TIG Welding | 13 |
| Plasma Cutting | 14 |
| Stick Welding | 15 |
| Seperate Mode | 16 |
| Smart Memory | 17 |
| Basic Knowledge of Welding | 18-25 |
| MAINTENANCE | 26 |
| TROUBLESHOOTING | 27-34 |
| OBSERVE ALL SAFETY GUIDELINES DETAILED THROUGHOUT THIS MANUAL | 27 |
| MIG WELDING ISSUES | 28-29 |
| TIG WELDING ISSUES | 30-31 |
| STICK WELDING ISSUES | 32 |
| CUTTING ISSUES | 33-34 |

SAFETY

THANK YOU FOR SELECTING A QUALITY PRODUCT BY SSIMDER Welding Equipment Inc.

PLEASE EXAMINE CARTON AND EQUIPMENT FOR DAMAGE IMMEDIATELY

When this equipment is shipped, title passes to the purchaser upon receipt by the carrier. Consequently, claims for material damaged in shipment must be made by the purchaser against the transportation company at the time the shipment is received.

SAFETY DEPENDS ON YOU

SIMDER arc welding and cutting equipment is designed and built with safety in mind. However, your overall safety can be increased by proper installation ... and thoughtful operation on your part. **DO NOT INSTALL, OPERATE OR REPAIR THIS EQUIPMENT WITHOUT READING THIS MANUAL AND THE SAFETY PRECAUTIONS CONTAINED THROUGHOUT.** And, most importantly, think before you act and be careful.

WARNING

This statement appears where the information must be followed exactly to avoid serious personal injury or loss of life.

CAUTION

This statement appears where the information must be followed to avoid minor personal injury or damage to this equipment.

KEEP YOUR HEAD OUT OF THE FUMES.

DON'T get too close to the arc. Use corrective lenses if necessary to stay a reasonable distance away from the arc.

READ and obey the Safety Data Sheet (SDS) and the warning label that appears on all containers of welding materials.

USE ENOUGH VENTILATION or exhaust at the arc, or both, to



keep the fumes and gases from your breathing zone and the general area.

IN A LARGE ROOM OR OUTDOORS, natural ventilation may be adequate if you keep your head out of the fumes (See below).

USE NATURAL DRAFTS or fans to keep the fumes away from your face.

If you develop unusual symptoms, see your supervisor. Perhaps the welding atmosphere and ventilation system should be checked.

WEAR CORRECT EYE, EAR & BODY PROTECTION



PROTECT your eyes and face with welding helmet properly fitted and with proper grade of filter plate (See ANSI Z49.1).

PROTECT your body from welding spatter and arc flash with protective clothing including woolen clothing, flame-proof apron and gloves, leather leggings, and high boots.

PROTECT others from splatter, flash, and glare with protective screens or barriers.

IN SOME AREAS, protection from noise may be

appropriate.

BE SURE protective equipment is in good condition.

Also, wear safety glasses in work area

AT ALL TIMES.



SPECIAL SITUATIONS

DO NOT WELD OR CUT containers or materials which previously had been in contact with hazardous substances unless they are properly cleaned. This is extremely dangerous.

DO NOT WELD OR CUT painted or plated parts unless special precautions with ventilation have been taken. They can release highly toxic fumes or gases.

Additional precautionary measures.

PROTECT compressed gas cylinders from excessive heat, mechanical shocks, and arcs; fasten cylinders so they cannot fall.

BE SURE cylinders are never grounded or part of an electrical circuit.

REMOVE all potential fire hazards from welding area.

ALWAYS HAVE FIRE FIGHTING EQUIPMENT READY FOR IMMEDIATE USE AND KNOW HOW TO USE IT.



SAFETY



WARNINGS



CALIFORNIA PROPOSITION 65 WARNINGS



WARNING: Breathing diesel engine exhaust exposes you to chemicals known to the State of California to cause cancer and birth defects, or other

reproductive harm.

- Always start and operate the engine in a well-ventilated area.
- If in an exposed area, vent the exhaust to the outside.
- Do not modify or tamper with the exhaust system.
- Do not idle the engine except as necessary.

For more information go to
www.P65warnings.ca.gov/diesel

WARNING: This product, when used for welding or cutting, produces fumes or gases which contain chemicals known to the State of California to cause birth defects and, in some cases, cancer. (California Health & Safety Code § 25249.5 et seq.)



WARNING: Cancer and Reproductive Harm
www.P65warnings.ca.gov

ARC WELDING CAN BE HAZARDOUS. PROTECT YOURSELF AND OTHERS FROM POSSIBLE SERIOUS INJURY OR DEATH. KEEP CHILDREN AWAY. PACEMAKER WEARERS SHOULD CONSULT WITH THEIR DOCTOR BEFORE OPERATING.

Read and understand the following safety highlights. For additional safety information, it is strongly recommended you download free PDF of Standard ANSI Z49.1 from the American Welding Society.
<https://www.aws.org/library/doclib/AWS-Z49-2021.pdf>

BE SURE THAT ALL INSTALLATION, OPERATION, MAINTENANCE AND REPAIR PROCEDURES ARE PERFORMED ONLY BY QUALIFIED INDIVIDUALS.



FOR ENGINE POWERED EQUIPMENT.

1.a. Turn the engine off before troubleshooting and maintenance work unless the maintenance work requires it to be running.

1.b. Operate engines in open, well-ventilated areas or vent the engine exhaust fumes outdoors.

1.c. Do not add the fuel near an open flame welding arc or when the engine is running. Stop the engine and allow it to cool before refueling to prevent spilled fuel from vaporizing on contact with hot engine parts and igniting. Do not spill fuel when filling tank. If fuel is spilled, wipe it up and do not



start engine until fumes have been eliminated.

1.d. Keep all equipment safety guards, covers and devices in position and in good repair. Keep hands, hair, clothing and tools away from V-belts, gears, fans and all other moving parts when starting, operating or repairing equipment.



1.e. In some cases it may be necessary to remove safety guards to perform required maintenance. Remove guards only when necessary and replace them when the maintenance requiring their removal is complete. Always use the greatest care when working near moving parts.

1.f. Do not put your hands near the engine fan. Do not attempt to override the governor or idler by pushing on the throttle control rods while the engine is running.

1.g. To prevent accidentally starting gasoline engines while turning the engine or welding generator during maintenance work, disconnect the spark plug wires, distributor cap or magneto wire as appropriate.

1.h. To avoid scalding, do not remove the radiator pressure cap when the engine is hot.



ELECTRIC AND MAGNETIC FIELDS MAY BE DANGEROUS



2.a. Electric current flowing through any conductor causes localized Electric and Magnetic Fields (EMF). Welding current creates EMF fields around welding cables and welding machines

2.b. EMF fields may interfere with some pacemakers, and welders having a pacemaker should consult their physician before welding.

2.c. Exposure to EMF fields in welding may have other health effects which are now not known.

2.d. All welders should use the following procedures in order to minimize exposure to EMF fields from the welding circuit:

2.d.1. Route the electrode and work cables together - Secure them with tape when possible.

2.d.2. Never coil the electrode lead around your body.

2.d.3. Do not place your body between the electrode and workcables. If the electrode cable is on your right side, the work cable should also be on your right side.

2.d.4. Connect the work cable to the workpiece as close as possible to the area being welded.

2.d.5. Do not work next to welding power source.

SAFETY



ELECTRIC SHOCK CAN KILL.



- 3.a. The electrode and work (or ground) circuits are electrically "hot" when the welder is on. Do not touch these "hot" parts with your bare skin or wet clothing. Wear dry, hole-free gloves to insulate hands.
- 3.b. Insulate yourself from work and ground using

ing dry insulation. Make certain the insulation is large enough to cover your full area of physical contact with work and ground.

In addition to the normal safety precautions, if welding must be performed under electrically hazardous conditions (in damp locations or while wearing wet clothing; on metal structures such as floors, gratings or scaffolds; when in cramped positions such as sitting, kneeling or lying, if there is a high risk of unavoidable or accidental contact with the workpiece or ground) use the following equipment:

- Semiautomatic DC Constant Voltage (Wire) Welder.
- DC Manual (Stick) Welder.
- AC Welder with Reduced Voltage Control.

- 3.c. In semiautomatic or automatic wire welding, the electrode, electrode reel, welding head, nozzle or semiautomatic welding gun are also electrically "hot".
- 3.d. Always be sure the work cable makes a good electrical connection with the metal being welded. The connection should be as close as possible to the area being welded.
- 3.e. Ground the work or metal to be welded to a good electrical (earth) ground.
- 3.f. Maintain the electrode stringer, work clamp, welding cable and welding machine in good, safe operating condition. Replace damaged insulation.
- 3.g. Never dip the electrode in water for cooling.
- 3.h. Never simultaneously touch electrically "hot" parts of electrode holders connected to two welders because voltage between the two can be the total of the open circuit voltage of both welders.
- 3.i. When working above floor level, use a safety belt to protect yourself from a fall should you get a shock.
- 3.j. Also see It ems 6.c. and 8.



ARC RAYS CAN BURN.



- 4.a. Use a shield with the proper filter and cover plates to protect your eyes from sparks and the rays of the arc when welding or observing open arc welding. Headshield and filter lens should conform to ANSI Z87.1 standards.
- 4.b. Use suitable clothing made from durable flame-resistant material to protect your skin and that of your helpers from the arc rays.
- 4.c. Protect other nearby personnel with suitable, non-flammable screening and/or warn them not to watch the arc nor expose themselves to the arc rays or to hot spatter or metal.



FUMES AND GASES CAN BE DANGEROUS.



- 5.a. Welding may produce fumes and gases hazardous to health. Avoid breathing these fumes and gases. When welding, keep your head out of the fume. Use enough ventilation and/or exhaust at the arc to keep fumes and gases away from the breathing zone. **When welding hardfacing (see instructions on container or SDS) or on lead or cadmium plated steel and other metals or coatings which produce highly toxic fumes, keep exposure as low as possible and within applicable OSHA PEL and ACGIH TLV limits using local exhaust or mechanical ventilation unless exposure assessments indicate otherwise. In confined spaces or in some circumstances, outdoors, a respirator may also be required. Additional precautions are also required when welding on galvanized steel.**
- 5.b. The operation of welding fume control equipment is affected by various factors including proper use and positioning of the equipment, maintenance of the equipment and the specific welding procedure and application involved. Worker exposure level should be checked upon installation and periodically thereafter to be certain it is within applicable OSHA PEL and ACGIH TLV limits.
- 5.c. Do not weld in locations near chlorinated hydrocarbon vapors coming from degreasing, cleaning or spraying operations. The heat and rays of the arc can react with solvent vapors to form phosgene, a highly toxic gas, and other irritating products.
- 5.d. Shielding gases used for arc welding can displace air and cause injury or death. Always use enough ventilation, especially in confined areas, to insure breathing air is safe.
- 5.e. Read and understand the manufacturer's instructions for this equipment and the consumables to be used, including the Safety Data Sheet (SDS) and follow your employer's safety practices. SDS forms are available from your welding distributor or from the manufacturer.
- 5.f. Also see item 1.b.

SAFETY



WELDING AND CUTTING SPARKS CAN CAUSE FIRE OR EXPLOSION.



- 6.a. Remove fire hazards from the welding area. If this is not possible, cover them to prevent the welding sparks from starting a fire. Remember that welding sparks and hot materials from welding can easily go through small cracks and openings to adjacent areas. Avoid welding near hydraulic lines. Have a fire extinguisher readily available.
- 6.b. Where compressed gases are to be used at the job site, special precautions should be used to prevent hazardous situations. Refer to "Safety in Welding and Cutting" (ANSI Standard Z49.1) and the operating information for the equipment being used.
- 6.c. When not welding, make certain no part of the electrode circuit is touching the work or ground. Accidental contact can cause overheating and create a fire hazard.
- 6.d. Do not heat, cut or weld tanks, drums or containers until the proper steps have been taken to insure that such procedures will not cause flammable or toxic vapors from substances inside. They can cause an explosion even though they have been "cleaned". For information, purchase "Recommended Safe Practices for the Preparation for Welding and Cutting of Containers and Piping That Have Held Hazardous Substances", AWS F4.1 from the American Welding Society (see address above).
- 6.e. Vent hollow castings or containers before heating, cutting or welding. They may explode.
- 6.f. Sparks and spatter are thrown from the welding arc. Wear oil free protective garments such as leather gloves, heavy shirt, cuffless trousers, high shoes and a cap over your hair. Wear ear plugs when welding out of position or in confined places. Always wear safety glasses with side shields when in a welding area.
- 6.g. Connect the work cable to the work as close to the welding area as practical. Work cables connected to the building framework or other locations away from the welding area increase the possibility of the welding current passing through lifting chains, crane cables or other alternate circuits. This can create fire hazards or overheat lifting chains or cables until they fail.
- 6.h. Also see item 1.c.
- 6.i. Read and follow NFPA 51B "Standard for Fire Prevention During Welding, Cutting and Other Hot Work", available from NFPA, 1 Batterymarch Park, PO box 9101, Quincy, MA 022690-9101.
- 6.j. Do not use a welding power source for pipe thawing.



CYLINDER MAY EXPLODE IF DAMAGED.

- 7.a. Use only compressed gas cylinders containing the correct shielding gas for the process used and properly operating regulators designed for the gas and pressure used. All hoses, fittings, etc. should be suitable for the application and maintained in good condition.
- 7.b. Always keep cylinders in an upright position securely chained to an undercarriage or fixed support.
- 7.c. Cylinders should be located:
 - Away from areas where they may be struck or subjected to physical damage.
 - A safe distance from arc welding or cutting operations and any other source of heat, sparks, or flame.
- 7.d. Never allow the electrode, electrode stringer or any other electrically "hot" parts to touch a cylinder.
- 7.e. Keep your head and face away from the cylinder valve outlet when opening the cylinder valve.
- 7.f. Valve protection caps should always be in place and hand tight except when the cylinder is in use or connected for use.
- 7.g. Read and follow the instructions on compressed gas cylinders, associated equipment, and CGA publication P-1, "Precautions for Safe Handling of Compressed Gases in Cylinders," available from the Compressed Gas Association, 14501 George Carter Way Chantilly, VA 20151.



FOR ELECTRICALLY POWERED EQUIPMENT.



- 8.a. Turn off input power using the disconnect switch at the fuse box before working on the equipment.
- 8.b. Install equipment in accordance with the U.S. National Electrical Code, all local codes and the manufacturer's recommendations.
- 8.c. Ground the equipment in accordance with the U.S. National Electrical Code and the manufacturer's recommendations.

GENERAL DESCRIPTION

GENERAL FUNCTIONAL DESCRIPTION

The Simder SD-4050Pro is an inverter welder based on IGBT inverter technology. This makes the machine lightweight and allows for multiple advanced functions. Before we move on to a detailed explanation of how to set up the welder, let's explain some of its features and their purpose.

Pulse MIG offers top quality, consistent welding with fairly low spatter compared to conventional MIG welders. Pulse MIG can help you take on all kinds of welding jobs from small parts to large automotive and motorcycle pieces, photo frames, high-power integrated circuit packages.

Synergic MIG welding automatically adjusts the voltage and wire feeding speed based on the amperage or the metal thickness selection. This makes the MIG welding process easier for beginners so that they don't have to manually adjust the wire feed speed and the voltage settings.

High frequency Start TIG Welding allows the operator to position the tungsten electrode near the job, and simply press the torch trigger to start the arc. The non-touch ignition allows you to position your torch accurately on every joint, even when it comes to awkward angles such as 90 degree joints or round pipe welding.

If the welder ever gets overheated, it will activate its self-protection mechanism by shutting down in order to cool down, prolonging its life span. However, thanks to the advanced IGBT technology, the SD-4050Pro has a 60% duty cycle at 180 A output when welding, and a 60% duty cycle at 40A when plasma cutting, giving you 6 out of 10 minutes intervals of working time.

This welder outputs DC current. So, it can weld mild steel and stainless steel.

Like any arc welding machine, the SD-4050Pro requires you to correctly set up the polarities to initiate the arc in a closed electric circuit. This means that to run any of its five processes, you must connect the work clamp to the metal and use the MIG/TIG/Stick/Plasma torch to close the circuit. It also requires a shielding gas for MIG and TIG processes and pressurized air for the plasma cutting process. So let's get started with an explanation of each.

RECOMMENDED PROCESSES

SD-4050Pro is designed for SMAW, GTAW (HF TIG), GMAW, FCAW and Plasma cutting.

| WELD MODE | PROCESS | COMMON MATERIALS | COMMON ELECTRODES |
|----------------|----------------|---------------------------------------|-------------------|
| GTAW | HF TIG | STEEL | |
| SMAW | STICK | STEEL | 6011, 7018 |
| GMAW | MIG/MAG | STAINLESS, STEEL | ER70S-6 ER308L |
| FCAW | FLUX CORE | STEEL | E71T-GS |
| PLASMA CUTTING | CUT | STEEL, Stainless Steel Aluminum | |
| PULSE MIG | PULSE ALUMINUM | ALUMINUM | |

SPECIFICATION

TECHNICAL SPECIFICATIONS: SD-4050PRO

| INPUT-SINGLE PHASE ONLY | | | | |
|-----------------------------|----------------|----------------------|--------------------------|------------------------|
| Standard Voltage/Frequency | | | Input Current | |
| 220V±10% 50/60Hz | | | I1 max=29A, I1Leff=22.4A | |
| 110V±10% 50/60Hz | | | I1 max=45A, I1Leff=34.8A | |
| RATED OUTPUT - DC ONLY | | | | |
| Voltage | Mode | Duty Cycle | Current | Volts at Rated Current |
| 220V | GMAW | 60% | 200A | 24V |
| | | 100% | 154A | 21.7V |
| | SMAW | 60% | 200A | 28V |
| | | 100% | 154A | 26.1V |
| | GTAW | 60% | 200A | 18V |
| | | 100% | 154A | 16.1V |
| Plasma Cutting | 60% | 50A | 100V | |
| | 100% | 38A | 95.2V | |
| 110V | GMAW | 60% | 140A | 21V |
| | | 100% | 108A | 19.4V |
| | SMAW | 60% | 140A | 25.6V |
| | | 100% | 108A | 24.3V |
| | GTAW | 60% | 140A | 15.6V |
| | | 100% | 108A | 14.3V |
| Plasma Cutting | 60% | 40A | 96V | |
| | 100% | 30A | 92V | |
| OUTPUT RANGE | | | | |
| Voltage | Mode | Open Circuit Voltage | Welding Current Range | Welding Voltage Range |
| 220V | GMAW | 60V | 40A~200A | 16V~24V |
| | SMAW | | 20A~200A | 20.8V~28V |
| | GTAW | | 20A~200A | 10.8V~18V |
| | Plasma Cutting | 280V | 20A~50A | 88V~100V |
| 110V | GMAW | 60V | 30A~155A | 16V~21V |
| | SMAW | | 25A~140A | 20.8V~25.6V |
| | GTAW | | 15A~155A | 10.8V~15.6V |
| | Plasma Cutting | 280V | 25A~37A | 88V~96V |
| OTHER PARAMETERS | | | | |
| Machine | Power Factor | Efficiency | Protection Class | Insulation Class |
| SD-4050Pro | 0.93 | ≥80% | IP21S | F |
| TEMPERATURE RANGE | | | | |
| Operating Temperature Range | | | -10°C~+40°C(14F~104°F) | |
| Storage Temperature Range | | | -25°C~+55°C(-13°F~131°F) | |

OVERVIEW OF MACHINE

CASE FRONT CONTROLS

(See Figure 2)

FIGURE 2

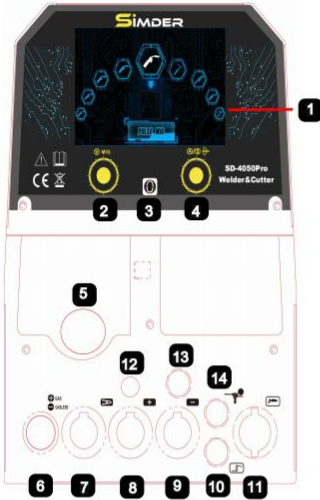

1. Upgraded LCD Screen
2. Voltage Adjustment / Menu Home Button
3. Main Menu Select Button
4. Wire feeding speed / Current Control / Menu Item Selection
5. MIG GUN Connection (EURO Connect)
6. Polarity Output for GAS MIG / Flux Cored MIG
7. Ground Clamp Connection for Plasma Cutter
8. Positive Polarity Terminal
9. Negative Polarity Terminal
10. Two Pin Trigger Receptacle for Plasma Cutting Torch and TIG Torch / Foot Pedal
11. Plasma Cutting Torch and TIG Torch Connection
12. Ground Connection for Plasma Cutter
13. Three Pin Trigger Receptacle for Foot Pedal
14. Two Pin Trigger Receptacle for Spool Gun

CASE BACK CONTROLS

(See Figure 3)

FIGURE 3

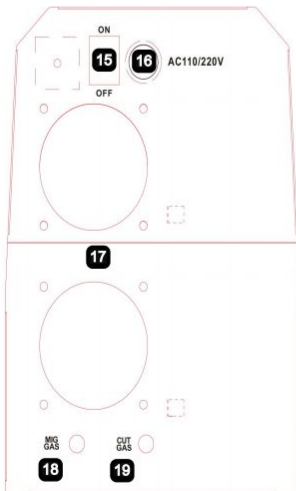

15. Power Switch Button
16. Power Cord
17. Dual Cooling Fan
18. MIG Gas Tube Connection
19. TIG Gas / Air Tube Connection

INSTALLATION

1.MIG Welding

Figure 4: GAS MIG/PULSE MIG

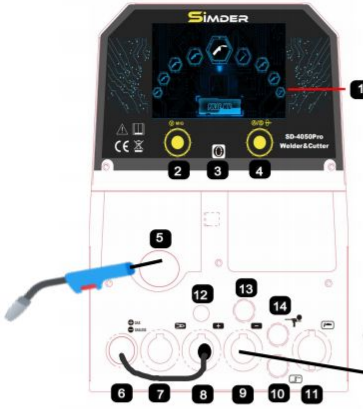

Figure 5: Flux Cored MIG



- ①When GAS MIG/Pulse MIG, **Change the Polarity output to "Terminal 8"**. Connect the MIG Torch to "**Terminal 5**" and connect the Ground Clamp to "**Terminal 9**". (see Figure 4)
- ②When Flux Core Welding(Gasless), **Change the Polarity output to "Terminal 9"**. Connect the MIG Torch to "**Terminal 5**" and connect the Ground Clamp to "**Terminal 8**". (see Figure 5)

*Always **TURN OFF** All the Power and Disconnect the Ground Clamp before Changing Polarity.

*MIG Welding with a Spool Gun

Figure 6: Spool Gun for Gas MIG



Figure 7: Spool Gun for Flux Cored



Figure 8

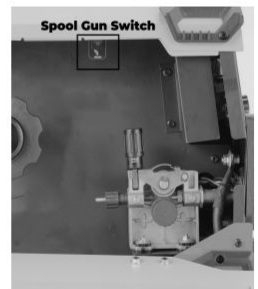

①When using a Spool Gun for Gas MIG/Pulse MIG, **Change the Polarity output to "Terminal 8"**. Connect the Spool Gun to "**Terminal 5**" and connect the Ground Clamp to "**Terminal 9**". (see Figure 6)

②When using a Spool Gun for Flux Cored MIG, **Change the Polarity output to "Terminal 9"**. Connect the Spool Gun to "**Terminal 5**" and connect the Ground Clamp to "**Terminal 8**". (see Figure 7)

③Turn on the Spool Gun Switch. (See Figure 8)

Caution: Always turn off the switch when need to switch back to the regular MIG torch.

*Always **TURN OFF** All the Power and Disconnect the Ground Clamp before Changing Polarity.

INSTALLATION

2.DC/ HF TIG Welding

Figure 9

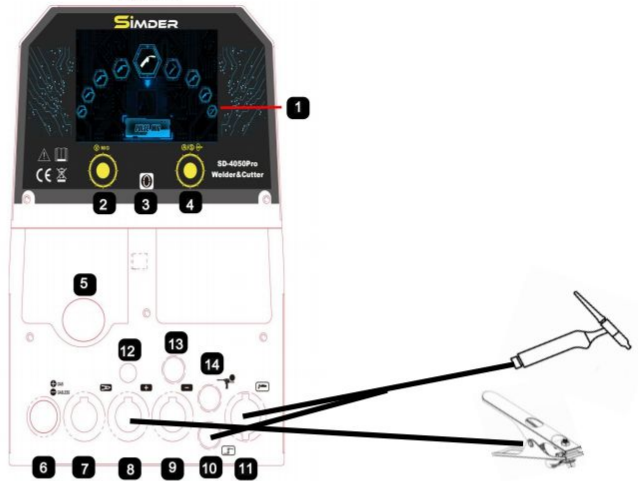

Connect the TIG Torch to **"Terminal11"** and the two-Pin control switch to **"Terminal10"**, then connect the Ground Clamp to **"Terminal 8"**. (See Figure 9)

TIG Welding with Foot Pedal

Figure 10

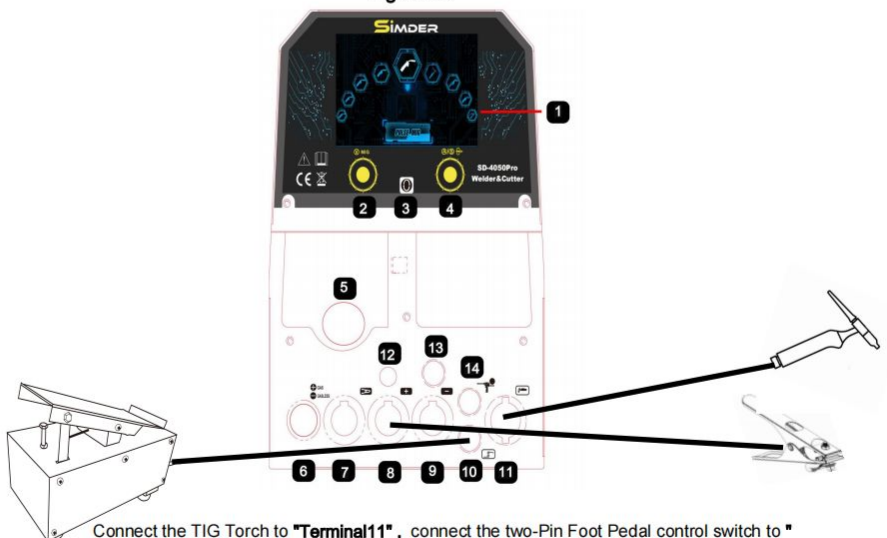

Connect the TIG Torch to **"Terminal11"**, connect the two-Pin Foot Pedal control switch to **"Terminal10"**, then connect the Ground Clamp to **"Terminal 8"**.

Note: If you are using a three-pin Foot Pedal control, connect it to **"Terminal13"**. (See Figure 10)

INSTALLATION

3.MMA Welding

Figure 11

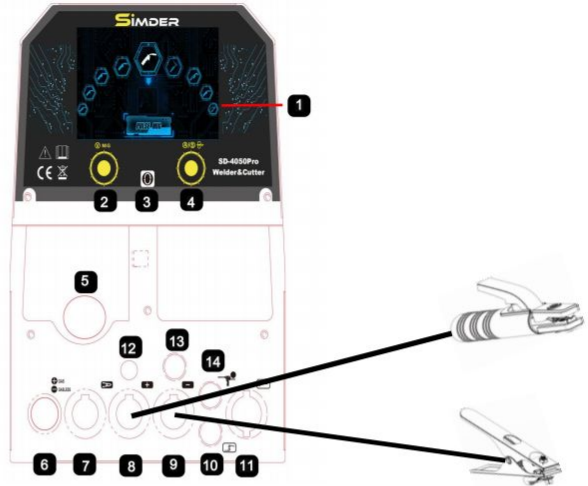

Connect the Electrode Holder to **"Terminal 8"** and the Ground Clamp to **"Terminal 9"**. (See in Figure 11)

4.Plasma Cutting

Figure 12

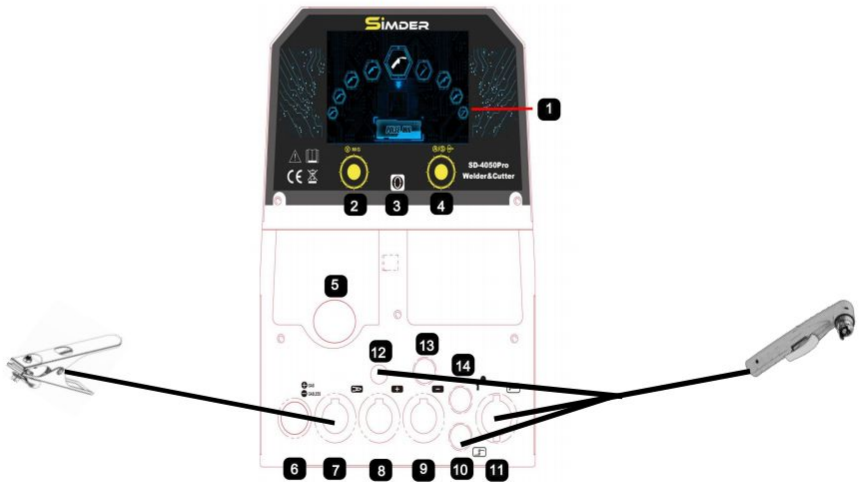

Connect the CuttingTorch to **"Terminal 11"** and the two-pin control switch to **"Terminal 10"**, connect the ground cord on torch to **"Terminal 12"**, then connect the Ground Clamp to **"Terminal 7"**. (See in Figure 12)

INSTALLATION

5. Plasma Cutting Air Compressor

Figure 13

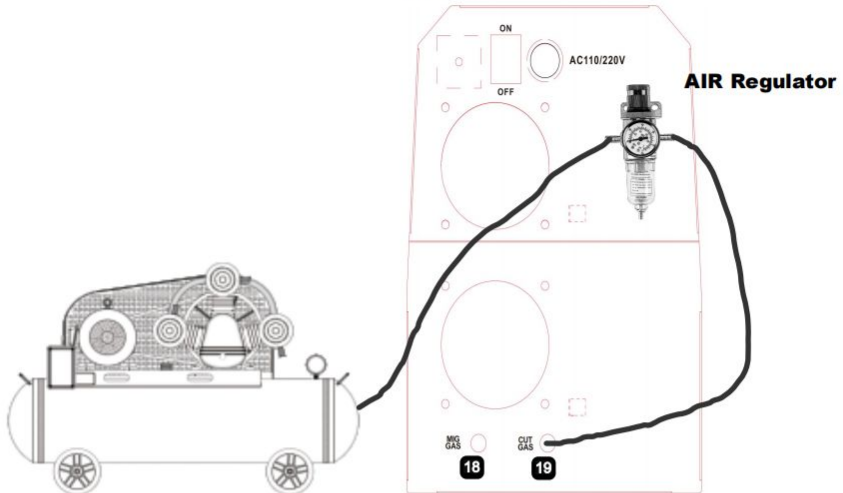

Connect one side of the GAS Tube to Air Compressor then connect the other side to Air Regulator, Connect the Air Regulator to **"Terminal 19"**. (See in Figure 13)

6. Gas Tank Installation for MIG/TIG

Figure 14

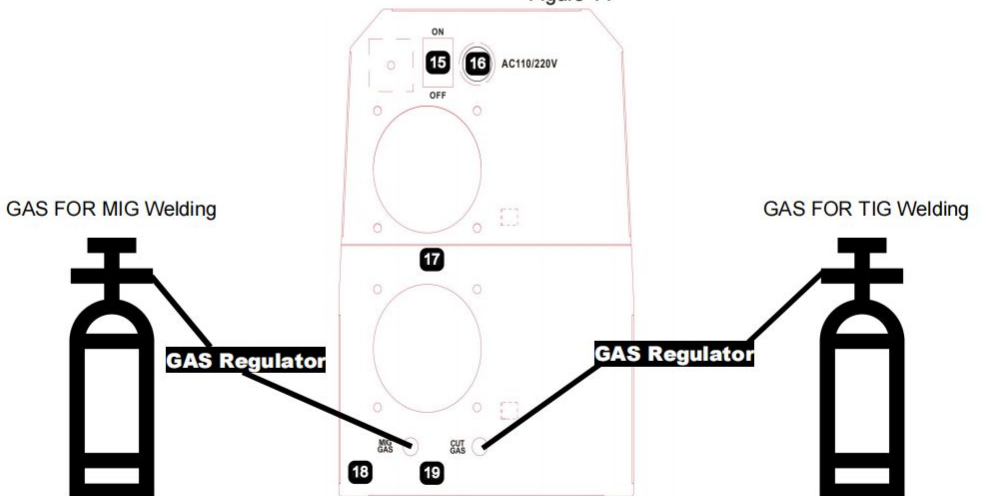

Gas MIG Welding - Connect the Gas Tank to a Gas regulator then connect the gas tube to **"Terminal 18"**.

TIG Welding - Connect the Gas Tank to a Gas regulator then connect the gas tube to **"Terminal 19"**. (See in Figure 14)

OPERATION

1. MIG SETTINGS



Main Menu Explanations:

Pulse MIG - Allows to MIG weld Aluminum

CO2 100% - Allows to MIG weld with 100% CO2

AR 100% - Allows to MIG weld with 100% Argon Gas

MIX GAS - Allows to MIG weld with Mixed Gas

FLUX - Allows to Gasless MIG weld with Flux Cored Wire

Rotate the right **current button** to the proper MIG function, then Press **Menu select button** in the middle to ENTER.

MIG Function Page Settings

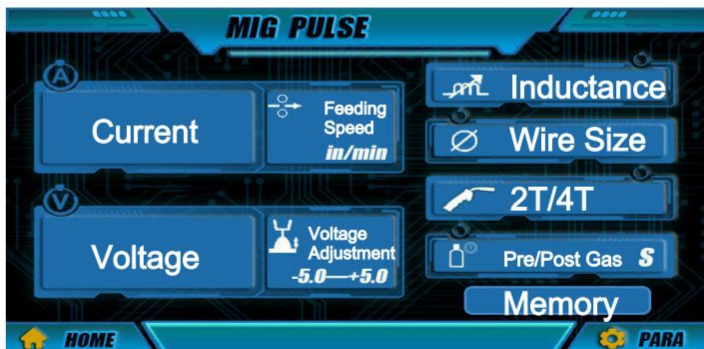

When in Pulse MIG/ CO2 100%/ AR 100%/ MIG GAS/ FLUX mode, rotate the **current button** to adjust current/feeding speed, and **voltage button** to adjust the voltage.

If you need to make adjustment on other parameters(Inductance, wire size, 2t/4t, pre/post gas), press the **Menu button** to switch, then rotate the **current button** to adjust the parameters.

Note: Pre/Post Gas setting is not applicable for FLUX mode.

OPERATION

2. TIG SETTINGS



Main Menu Explanations:

Rotate the right **current button** to HF TIG function, then Press **Menu select button** in the middle to ENTER.

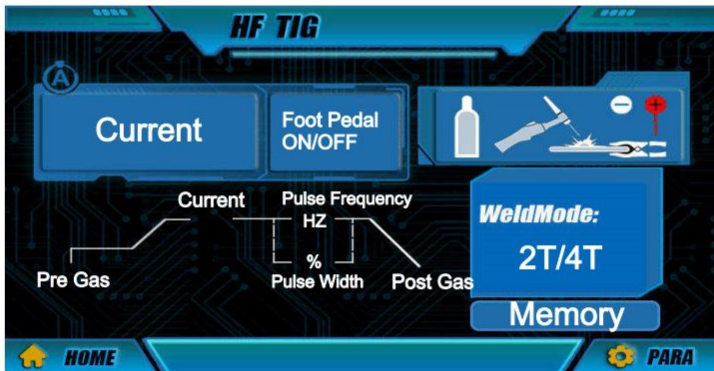

When in HF TIG mode, rotate the **current button** to adjust current.

If you need to make adjustment on other parameters(Pulse Frequency, Pulse Width, 2t/4t, pre/post gas), press the **Menu button** to switch, then rotate the **current button** to adjust the parameters.

Note: When Pulse Frequency sets to 0 , TIG Function will be regular DC TIG Welding.

HF TIG function will be activated when pulse frequency sets > 0.

*Pleas set "Foot Pedal on" when need to TIG weld with Foot Pedal.

3. PLASMA CUTTING SETTINGS



Main Menu Explanations:

Rotate the right **current button** to **PLASMA** function, then Press **Menu select button** in the middle to ENTER.

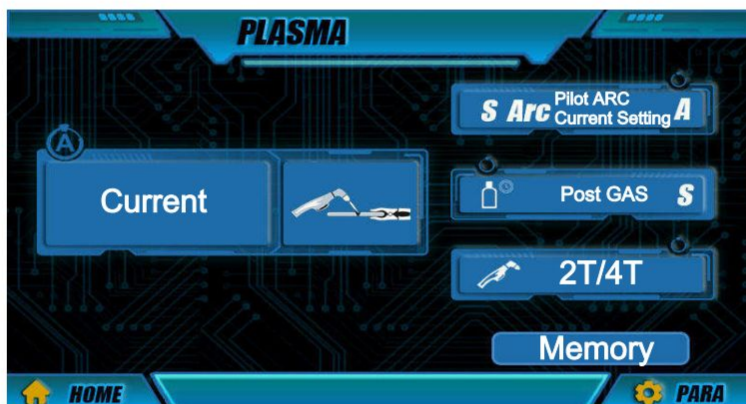

When in Plasma Cutting mode, rotate the **current button** to adjust current.

If you need to make adjustment on other parameters(Pilot ARC Current, 2t/4t, post gas), press the **Menu button** to switch, then rotate the **current button** to adjust the parameters.

4. MMA/STICK SETTINGS



Main Menu Explanations:

Rotate the right **current button** to **MMA** function, then Press **Menu select button** in the middle to ENTER.

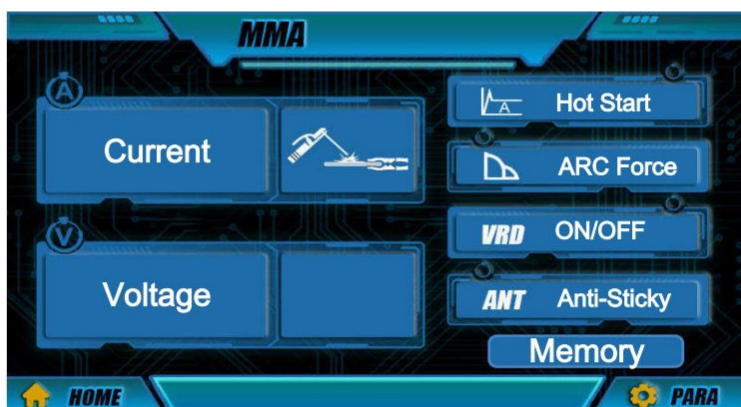

When in MMA mode, rotate the **current button** to adjust current and **voltage button** to adjust the voltage.

If you need to make adjustment on other parameters(Hot start, ARC force, VRD on/off and anti sticky mode), press the **Menu button** to switch, then rotate the **current button** to adjust the parameters.

5. SEPERATE MODE



Main Menu Explanations:

SEPERATE mode is for MIG Welding, it allows to separately set up all the parameters by yourself.

Rotate the right **current button** to **SEPERATE** function, then Press **Menu select button** in the middle to **ENTER**.

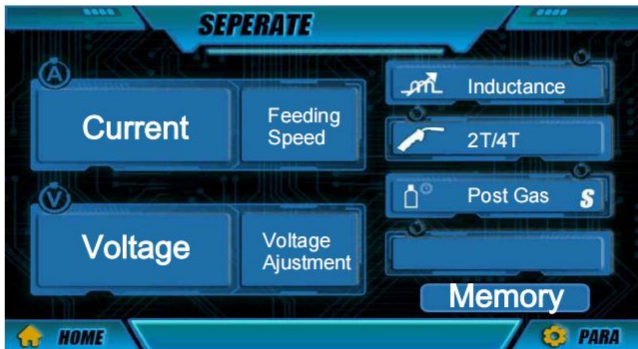

When in MMA mode, rotate the **current button** to adjust current and **voltage button** to adjust the voltage.

If you need to make adjustment on other parameters(Inductance, 2T/4T, Post Gas) , press the **Menu button** to switch, then rotate the **current button** to adjust the parameters.

6. Smart Memory Mode

Smart Memory Mode Settings

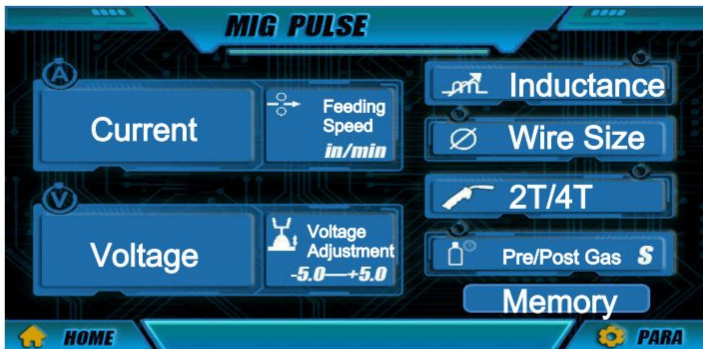

Main Menu Explanations:

Memory mode is available on **ALL Welding/Cutting Mode**.

When in Each function Page, Press **Menu select button** and select **Memory**, Press **Current Button** to enter the Memory mode.

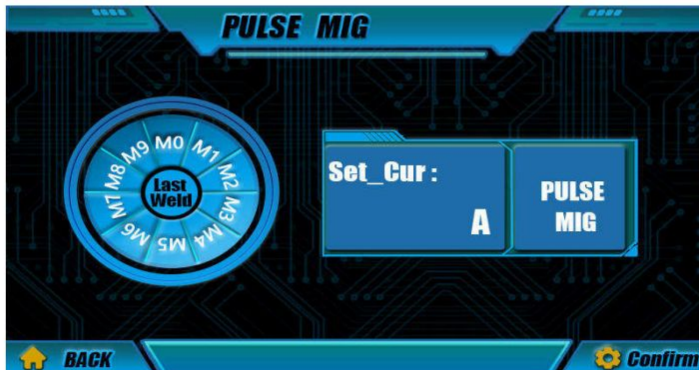

Memory Mode allows you to save 10 sets of Parameters on each welding mode, from M0 to M9.

When entered the Memory mode page, rotate the **Current Button** to select from **M0 to M9** that you want to save your parameters, then press **Current Button** to Confirm.

For example, if you select M0, When this is done, press **Voltage Button** to go back to welding page, your welding parameters will automatically save to M0.

BASIC KNOWLEDGE OF WELDING

Basic Knowledge of Stick

Manual metal arc welding (MMA/Stick) is arc welding by manually operating electrodes. Stick requires simple equipment and is a convenient, flexible, and adaptive welding processing type. Stick is applied to various metal materials with thicknesses of more than 2mm. It's suitable for various material structures, particularly for workpieces with complex structures and shapes, short weld joints or bending shapes, as well as weld joints in various spatial locations.

Welding Process of Stick

Connect the two output terminals of the welder to the workpiece and electrode holder respectively, and then clamp the electrode by the electrode holder. When welding, the arc is ignited between the electrode and the workpiece, and the end of the electrode and part of the workpiece is fused to form a welding crater under the high-temperature arc. The weld crater is quickly cooled and condensed to form a weld joint that can firmly integrally connect two separate pieces of the workpiece. The coating of the electrode is fused to produce slag to cover the weld crater. The cooled slag can form a slag crust to protect the weld joint. The slag crust is removed at last, and the joint welding is finished.

Tools for Stick

Common tools for Stick include electrode holder, welding mask, slag hammer, wire brush, welding cable, and labor protection supplies.



- a) **Electrode holder:** a tool for clamping electrode and conducting current, mainly including 300A type and 500A type.
- b) **Welding mask:** a shielding tool for protecting eyes and face from injury due to arc and spatter, including hand holding type and helmet type. Colored chemical glass is installed on the viewing window of the mask to filter ultraviolet rays and infrared rays. Arc burning condition and weld crater condition can be observed from the viewing window during welding. Thus, welding can be carried out by operators conveniently.
- c) **Slag hammer (peen hammer):** for the use of removing slag crust on the surface of the weld joint.
- d) **Wire brush:** for the use of removing dirt and rust at the joints of the workpiece before welding, as well as cleaning the surface of the weld joint and the spatter after welding.
- e) **Welding cable:** generally cables formed from many fine copper wires. Both YHH type arc welding rubber sleeve cable and THHR type arc welding rubber sleeve extra-flexible cable can be used. The electrode holder and welding machine are connected via a cable, and this cable is named as welding cable (live wire). The welding machine and workpiece are connected via another cable (earth wire). The electrode holder is covered with insulating material performing insulation and heat insulating.

Basic Operation of Stick

1) Welding joint cleaning

Rust and greasy dirt at the joint should be removed completely before welding in order to implement arc igniting and arc stabilizing conveniently as well as ensure the quality of the weld joint. A wire brush can be used for conditions with low requirements for dust removal; a grinding wheel can be used for conditions with high requirements for dust removal.

2) Posture in operating

Take flat welding of butt joint and T-shaped joint from left to right as an example. The operator should stand on the right side of the working direction of the weld joint with a mask in the left hand and an electrode holder in the right hand. The left elbow of the operator should be put on his left knee to prevent his upper body from following downwards, and his arm should be separated from the costal part so as to stretch out freely.

BASIC KNOWLEDGE OF WELDING



Posture in Welding

3) Arc Igniting

Arc igniting is the process of producing a stable arc between electrode and workpiece in order to heat them to implement welding. Common arc ignition mode includes scraping mode and striking mode. (See Fig.15) During welding, touch the surface of the workpiece with the end of the electrode by scraping or light striking to form a short circuit, and then quickly lift the electrode 2~4mm away to ignite the arc. If arc ignition fails, it is probably because there is coating at the end of the electrode, which affects the electric conduction. In this case, the operator can strongly knock the electrode to remove the insulation material until the metal surface of the core wire can be seen.

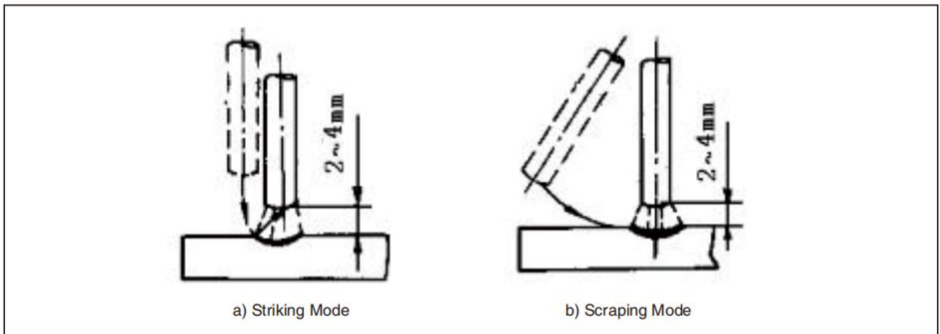

Fig 15 Arc Extinguishing Modes

4) Tack Weld

For fixing the relative positions of the two pieces of weldment and welding conveniently, 30~40mm short weld joints are welded every certain distance in order to fix the relative positions of the workpiece during welding assembly. This process is named tack weld.

BASIC KNOWLEDGE OF WELDING

5) Electrode Manipulation

The electrode manipulation actually is a resultant movement in which the electrode simultaneously moves in three basic directions: the electrode gradually moves along the welding direction; the electrode gradually moves toward the weld crater, and the electrode transversely swings. (See Fig 16) Electrode should be correctly manipulated in three movement directions after the arc is ignited. In butt welding and flat welding, the most important is to control the following three aspects: welding angle, arc length, and welding speed.

(1) **Welding angle:** the electrode should be inclined $70^{\circ} \sim 80^{\circ}$ forwards. (See Fig 17)

(2) **Arc length:** the proper arc length is equal to the diameter of the electrode in general.

(3) **Welding speed:** proper welding speed should make the crater width of the weld bead about twice the diameter of the electrode, and the surface of the weld bead should be flat with fine ripples. If the welding speed is too high, and the weld bead is narrow and high, the ripples are rough, and the fusion is not well implemented. If the welding speed is too low, the crater width is excessive, and the workpiece is easy to be burned through. Besides, the current should be proper, the electrode should be aligned, the arc should be low, and the welding speed should not be too high and should be kept uniform during the whole welding process.

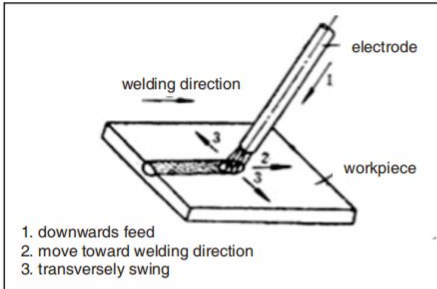

Fig 16 Three basic movement directions of electrode

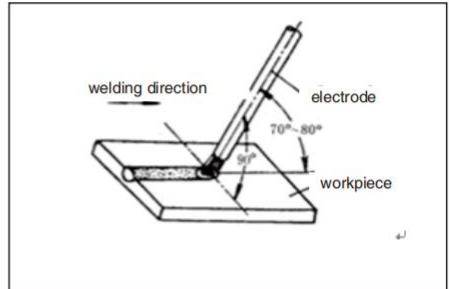

Fig 17 Angles of electrode in flat welding

6) Arc Extinguishing

Arc extinguishing is unavoidable during welding. Poor arc extinguishing may bring shallow weld craters and poor density and strength of weld metal by which cracks, air holes, slag inclusion, and shortage the like are easy to be produced. Gradually pull the end of the electrode to the groove and raise the arc when extinguishing the arc, in order to narrow the weld crater and reduce the metal and heat. Thus, defects such as cracks and air holes can be avoided. Pile up the weld metal of the crater to make the weld crater sufficiently transferred. Then, remove the excessive part after welding. The operation modes of arc extinguishing are shown in Fig 18.

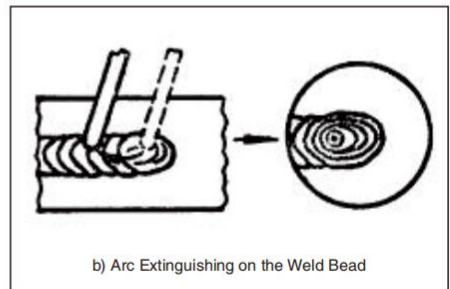
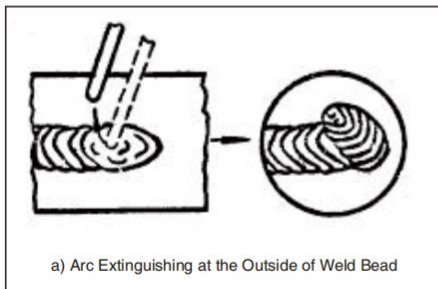

Fig 18 Arc Extinguishing Modes

7) Weldment Cleaning

Clean welding slag and spatter with wire brush and tools the like after welding.

Argon Arc Welding

General Description of Argon Arc Welding

Argon arc welding is a kind of gas shielded arc welding using argon as shield gas, and the process of argon arc welding is shown in Fig 19. Tightly close protective layer is formed in the arc zone by the argon gas flow output from the torch nozzle. Thus, the metal molten pool can be protected and separated from the air. Meanwhile, the filler wire and base metal are molten by the heat generated from the arc. After the liquid molten pool cools down, a weld bead is formed.

BASIC KNOWLEDGE OF WELDING

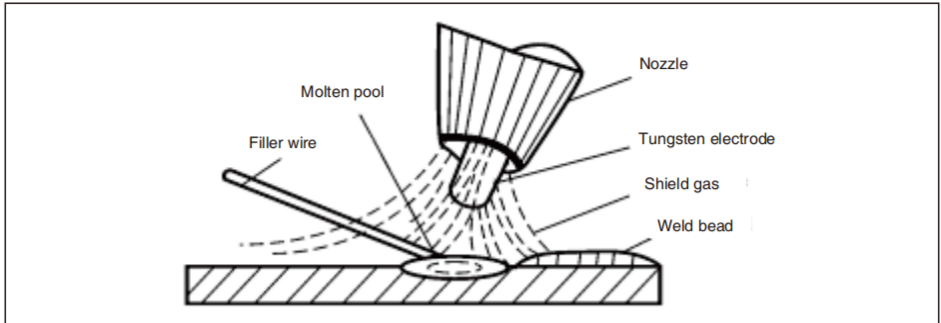

Fig 19 Sketch Map of Argon Arc Welding

Since argon is a kind of inert gas and it does not react with metals, the alloying elements in the weld metal will not be burned out and the metal molten pool can be fully protected from oxidation. Besides, because argon is insoluble in liquid metal at high temperatures, air holes can be avoided in the weld bead. Therefore, the protective effect of argon is effective and reliable, and better welding quality can be obtained.

Characteristics of Argon Arc Welding

Compared with other arc welding methods, argon arc welding has the following features.

1. Argon has excellent protective performance, so corresponding flux is not needed when welding. It is basically a simple process of metal melting and crystallization, and pure weld beads of high quality can be obtained.
2. Due to the compression and cooling effect of argon flow, the heat of the arc is concentrated at a high temperature. Therefore, the heat-affected zone is very narrow, and there is little welding deformation stress and crack tendency. Thus, argon arc welding is especially suitable for thin plate welding.
3. Argon arc welding is a kind of open flame welding and is easy to operate and observe, so the mechanization and automation of the welding process can be achieved easily. Besides, welding at various spatial locations can be carried out under certain conditions.
4. Argon arc welding can be applied to welding a wide range of welding materials. Almost all metal materials can be welded by argon arc welding, and it is especially suitable for welding chemically active metals and alloys. Generally, it is used in the welding of aluminum, titanium, copper, low alloy steel, stainless steel, refractory steel, etc.

With the increase in product structure of non-ferrous metals, high alloy steel, and rare metals, common gas welding methods and arc welding methods are difficult to obtain the required welding quality. However, argon arc welding is being more and more widely used due to its remarkable characteristics above.

Gas Tungsten Arc Welding (GTAW)

a) Welding Torch

The function of the welding torch for GTAW is to clamp the electrode, conduct current, and carry argon flow. For manual welding, the ON/OFF button is mounted on the handle of the welding torch. Generally, welding torches can be divided into three categories, large-type, medium-type, and small-type. For small-type welding torches, the maximum welding current is 100A. And the welding current can reach up to 400-600A for a large-type welding torch with water cooling. The torch body is pressed from nylon, so it is light, small-sized, insulated, and heat-resistant.

The torch nozzle plays an important part in the protective performance of argon. The common nozzle shapes are shown in Fig 18. Cylindrical nozzle with a cone-shaped or spherical end has the best protective effect, since the argon flow speed is uniform, and laminar flow is easy to hold. The protective effect of the coniform nozzle is worse because the argon flow speeds up. However, this kind of nozzle is easy to operate and the visibility of the molten pool is good, so it is also commonly used in welding.

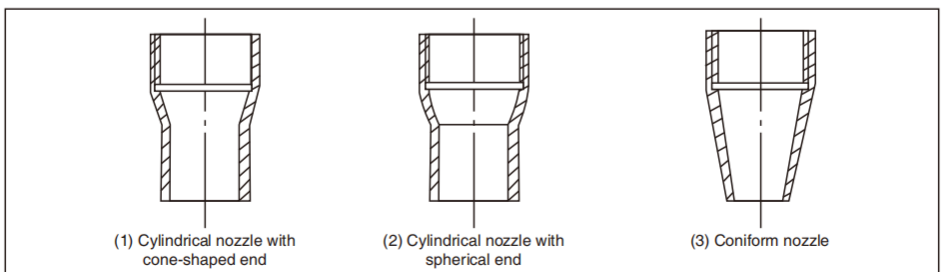

BASIC KNOWLEDGE OF WELDING

GTAW Process

1. Preweld cleaning

Clean the electrode and the zone near the weld joint of the workpiece, and remove impurities such as oil pollution and the oxidized film on the surface of the metal before carrying out argon arc welding to ensure good quality of weld bead. The methods for preweld cleaning are: mechanical cleaning, chemical cleaning and chemical & mechanical cleaning.

A. Mechanical cleaning: This method is simple with good effect, and it is suitable for large-sized workpiece. Generally, remove the oxidized film by grinding with a small-diameter stainless steel wire brush or by shoveling with a scraper to make the welding position appearing with metal luster, and then clean the weld joint zone with organic solvent for eliminating oil pollution.

B. Chemical cleaning: Chemical cleaning is commonly used for cleaning the filling electrode and small-sized workpiece. Compared with mechanical cleaning, this method has such characteristics as high cleaning efficiency, uniform and stable quality and long duration of clean state. The chemical solutions and processes used in chemical cleaning should be chosen according to the welding materials and welding requirements.

C. Chemical & mechanical cleaning: Use chemical cleaning method when cleaning firstly, and clean the welding position with mechanical cleaning method before welding. This combined cleaning method is suitable for the high quality welding.

2. Protective effect of gas

Argon is ideal protective gas. The boiling point of argon is -186°C , which is between that of helium and oxygen. Argon is a byproduct when the oxygen installation gets oxygen by fractionating the liquid air. Bottled argon is used for welding in our country. The filling pressure is 15MPa under room temperature, and the cylinder is painted gray and marked with "Ar". The chemical composition requirements of pure argon are: $\text{Ar} \geq 99.99\%$; $\text{He} \leq 0.01\%$; $\text{O}_2 \leq 0.0015\%$; $\text{H}_2 \leq 0.0005\%$; $\text{C} \leq 0.001\%$; $\text{H}_2\text{O} \leq 30\text{mg/m}^3$.

Welding arc can be better protected and the consumption of shield gas can be reduced in flat position welding. As inert gas, argon does not react with metal chemically even under high temperature. Thus, the alloying elements will not be oxidized or burned out, and problems caused accordingly will be avoided. Meanwhile, argon is insoluble in liquid metal, so air holes can be avoided. Argon is a kind of monatomic gas, existing in atomic state, without molecular decomposition and atomic endotherm under high temperature. Besides, the specific heat capacity and heat conductivity is low, so the arc heat is not easy to lose. Accordingly, the welding arc can burn stably and heat can be concentrated, which is advantageous to welding.

The disadvantage of argon is that its ionization potential is high. When the arc space is fully filled with argon, arc is hard to ignite. However, arc will become stable once it is successfully ignited.

The gas protective effect of argon can be affected by various process factors during welding. Therefore, special attention should be paid to the effective protection of argon in GTAW to avoid interference and damage. Otherwise, satisfactory welding quality is hard to obtain.

Welding process factors such as gas flow, shape and diameter of nozzle, distance between nozzle and workpiece, welding speed and weld joint form may affect the gas protective effect, so all these should be fully considered and chosen correctly.

The gas protective effect can be judged by welding spot testing method through measuring the size of the effective gas protective area. For example, keep all welding process factors fixed when carrying out spot welding on aluminum plate with AC manual TIG, maintain the torch in the fixed position after arc is ignited, and cut off the power after the 5-10s, there will be a molten welding spot left on the aluminum plate. Due to the cathode cleaning action against the area around the welding spot, the oxidized film on the surface of the aluminum plate is eliminated, and a gray area with metallic luster appears. As shown in Fig 20, this area is called effective argon protective area. The greater the diameter of the effective gas protective area, the better is the gas protective effect.

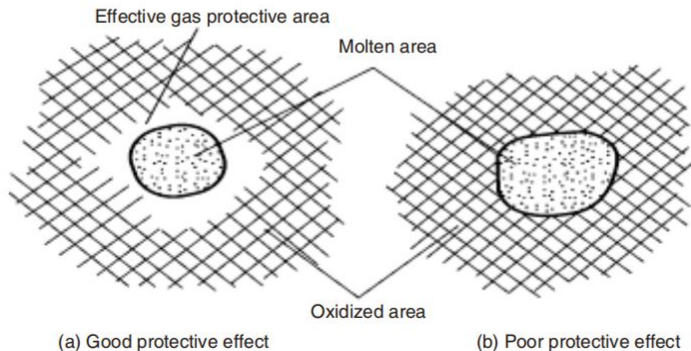

Fig 20 Effective protective area of argon

BASIC KNOWLEDGE OF WELDING

In addition, the gas protective effect can be judged by directly observing the color of the weld bead surface. Take stainless steel welding for example. If the weld bead surface appears silvery white or golden, it indicates that the gas protective effect is good. However, if the weld bead surface appears gray or black, it indicates that the gas protective effect is poor.

Welding Process Parameters

The gas protective effect, welding stability, and weld bead quality of GTAW have a direct relationship with the welding process parameters. Therefore, select appropriate welding process parameters to ensure high-quality weld joint.

The welding process parameters for GTAW include type and polarity of current, the diameter of tungsten electrode, welding current, argon gas flow, welding speed, and process factors, etc.

A. The type and polarity of current for GTAW should be chosen according to the workpiece material and also the operation mode.

B. Select tungsten electrodes with proper diameter mainly according to the thickness of the workpiece. Besides, when the thickness of the workpiece is the same, tungsten electrodes with different diameters should be chosen due to the different current types and polarities and different allowable current ranges for the tungsten electrode. Improper tungsten diameter will lead to unstable arc, serious burn, and tungsten in the weld bead.

C. Select proper welding current after the tungsten diameter is determined. Overly high or overly low welding current will cause poor weld bead or welding defects. For the allowable current ranges for thorium-tungsten/ cerium tungsten electrodes with different diameters, please refer to the table below (Table 1).

Table 1 Allowable Current Ranges for Tungsten Electrodes with Different Diameters

| Tungsten Dia. (mm) | DCEN (A) | DCEP (A) | AC (A) |
|--------------------|----------|----------|---------|
| 1.0 | 15-80 | - | 20-60 |
| 1.6 | 70-150 | 10-20 | 60-120 |
| 2.4 | 150-250 | 15-30 | 100-180 |
| 3.2 | 250-400 | 25-40 | 160-250 |
| 4.0 | 400-500 | 40-55 | 200-320 |

TIG Electrodes Specification Reference Table

| Material | Material Thickness | Amps | Tungsten Color | Tungsten Dia. | Filler Metal | Filler Metal Diameter | Ceramic Nozzle size | Gas Flow | Gas Flow Rate(SCFH) |
|-----------------|--------------------|----------|--------------------------|---------------|--------------|-----------------------|---------------------|----------|---------------------|
| Mild Steel | 1/16" | 55-90 | Grey, Orange, Red, White | 1/16" | ER70S-2 | 1/16" | #4 | 2 | 11-12 |
| Mild Steel | 1/32" | 90-120 | Grey, Orange, Red, White | 1/16" | ER70S-2 | 1/16" | #4-5 | 2 | 11-12 |
| Mild Steel | 1/8" | 95-135 | Grey, Orange, Red, White | 1/16"-3/32" | ER70S-2 | 3/32" | #5-6 | 10 | 11-12 |
| Mild Steel | 3/16" | 140-165+ | Grey, Orange, Red, White | 3/32" | ER70S-2 | 1/8" | #6-7 | 10 | 13-14 |
| Stainless Steel | 1/16" | 50-80 | Grey, Orange, Red, White | 1/16" | ER70S-2 | 1/16" | #4 | 2 | 11-12 |
| Stainless Steel | 1/32" | 80-110 | Grey, Orange, Red, White | 1/16" | ER70S-2 | 1/16" | #4-5 | 2 | 11-12 |
| Stainless Steel | 1/8" | 85-120 | Grey, Orange, Red, White | 1/16"-3/32" | ER70S-2 | 3/32" | #5-6 | 10 | 11-12 |
| Stainless Steel | 3/16" | 125-165+ | Grey, Orange, Red, White | 3/32" | ER70S-2 | 1/8" | #6-7 | 10 | 13-14 |

D. The argon gas flow is selected mainly according to the tungsten diameter and nozzle diameter. For a nozzle with a certain aperture, the argon gas flow should be appropriate. If the gas flow is too high, the gas flow speed will increase. Thus, it is difficult to maintain stable laminar flow, and the welding zone can not be well protected. Meanwhile, more arc heat will be taken away, which will affect the arc stability. If the gas flow is too low, the gas protective effect will be affected due to the interference of the environmental airflow. Generally, the argon gas flow should be within 3-20L/min.

E. Under the condition of fixed tungsten diameter, welding current, and argon gas flow, overly high welding speed will make the protective gas flow deviate from the tungsten electrode and molten pool, and the gas protective effect will be affected accordingly. Besides, the welding speed affects the weld bead shape significantly. Therefore, it is very important to select the appropriate welding speed.

F. Process factors mainly refer to the shape and diameter of the nozzle, the distance between the nozzle and workpiece, stick-out and the diameter of filling wire, etc. Although the change in these factors is not big, it has more or less influence on the welding process and gas protective effect. Therefore, all factors should be selected according to specific welding requirements.

Generally, the nozzle diameter should be within 5-20mm, the distance between the nozzle and workpiece should not be greater than 15mm, the stick-out should be 3-4mm, and the filling wire diameter should be selected according to the thickness of the workpiece.

BASIC KNOWLEDGE OF CUTTING

Basic Knowledge of CUT









General Description of CUT (Plasma Cutting)

1. Economic and practical, since it can cut metals by adopting compressed air as the plasma gas source.
2. The cutting speed has increased by 1.8 times when compared with oxyacetylene cutting.
3. It can cut thick steel plates conveniently and quickly.
4. And the post-flow function is available.
5. Metal workpiece such as stainless steel, copper, cast iron, and aluminum can all be cut.
6. With simple operation and high cutting speed, a smooth cutting surface can be obtained, and polishing is unnecessary.
7. It is easy to ignite an arc by adopting HF arc ignition or non-HF pilot arc ignition, especially non-HF pilot arc, which is safer and reliable.

Operation Method of CUT (Plasma Cutting)

1. Turn on the power switch of the machine, the power indicator illuminates and the preset CUT current will show on the screen.
2. Check the indicators normal and select proper working mode 2T or 4T.
3. Set cutting current according to the thickness of the workpiece.
4. Bring the copper nozzle of the cutting torch into contact with the workpiece (For models with pilot arc function, keep a distance of about 2mm between the copper nozzle of the torch and the workpiece.), and then push the torch trigger. After the arc is ignited and started, raise the cutting torch to the position about 1mm above the workpiece, and start cutting.

Notes for Cutting Operation

| | |
|--|--|
|  | <p>It is recommended not to ignite the arc in the air if not necessary, for it will shorten the electrode's lifespan and the torch's nozzle.</p> |
|  | <p>It is recommended to initiate the cutting from the edge of workpiece, unless penetration is needed.</p> |
|  | <p>Ensure spatters fly from the bottom of workpiece while cutting. If spatters fly from the top of workpiece, it indicates that the workpiece can not be fully cut because the cutting torch is moved too fast or the cutting current is too low.</p> |
|  | <p>Keep the nozzle slightly touching the workpiece or keep a short distance between the nozzle and workpiece. If the torch is pressed against the workpiece, the nozzle may stick to the workpiece, and smooth cutting is unavailable.</p> |
|  | <p>For cutting round workpiece or to meet precise cutting requirement, molding board or other assistant tools are needed.</p> |
|  | <p>It is recommended to pull the cutting torch while cutting.</p> |
|  | <p>Keep the nozzle of cutting torch upright over the workpiece, and check if the arc is moving with the cutting line. If the space is not enough, don't bend the cable too much, step on or press upon the cable to avoid suffocating of gas flow. The cutting torch may be burned because the gas flow is too small. Keep the cutting cable away from edge tools.</p> |
|  | <p>Clean up the spatters on the nozzle timely, for it will affect the cooling effect of the nozzle. Clean up the dust and spatters on the torch head after using everyday to ensure good cooling effect.</p> |

BASIC KNOWLEDGE OF CUTTING

The workpiece is not cut fully. This may be caused by:

The cutting current is too low.

The cutting speed is too high.

The electrode and nozzle of the torch are burned. The workpiece is too thick.

Molten slag drops from the bottom of workpiece. This may be caused by:

The cutting speed is too low.

The electrode and nozzle of the torch are burned.

The cutting current is too high.

Replacement of Electrode and Nozzle

When the phenomena below occur, the electrode and nozzle should be replaced. Otherwise, there will be strong arc in the nozzle, which will break down the electrode and the nozzle, or even burn the torch. Nozzles of different models are different, so ensure the nozzle is of the same model when replacing it.

- 1) Electrode wear > 1.5mm
- 2) Distortion of the nozzle
- 3) Cutting speed declining, arc with green flame
- 4) Difficult in arc ignition
- 5) Irregular cut

MAINTENANCE

GENERAL MAINTENANCE

This welder has been engineered to need minimal service providing that a few very simple steps are taken to properly maintain it.

1. Keep the cabinet cover closed at all times unless the wire needs to be changed or the drive pressure needs adjusting.
2. Keep all consumables (contact tips, nozzles, and liner) clean and replace when necessary.
3. Replace INPUT POWER CABLE, ground cable, work clamp, or gun assembly when damaged or worn.
4. Avoid directing grinding particles towards the welder. These conductive particles can build up inside the machine and cause severe damage.
5. Periodically clean dust, dirt, grease, etc. from your welder. Every six months or as necessary, remove the side panels from the welder and use compressed air to blow out any dust and dirt that may have accumulated inside the welder.



WARNING: DISCONNECT FROM POWER SOURCE WHEN CARRYING OUT THIS OPERATION.

7. The wire feed drive roller will eventually wear during normal use. With the correct pressure, the idler roller must feed the wire without slipping. If the grooves in the wire feed drive roller are worn deep enough that the idler roller and the wire feed drive roller make contact when the wire is in place between them, the wire feed drive roller must be replaced.

8. Check all cables periodically. They must be in good condition and not cracked.



WARNING: ELECTRIC SHOCK CAN KILL! Be aware that the ON/OFF SWITCH, when OFF, does not remove power from all internal circuitry in the welder. To reduce the risk of electric shock, always unplug the welder from its AC power source and wait several minutes for electrical energy to discharge before removing side panels.

CONSUMABLE MAINTENANCE

IT IS VERY IMPORTANT TO MAINTAIN THE CONSUMABLES TO AVOID THE NEED FOR PREMATURE REPLACEMENT OF THE GUN ASSEMBLY.

MAINTAINING THE CONTACT TIP:

The purpose of the CONTACT TIP is to transfer welding current to the welding wire while allowing the wire to pass through it smoothly.

Always use a contact tip stamped with the same diameter as the wire it will be used with.

1. If the wire burns back into the tip, remove the tip from the gun and clean the hole running through it with an oxygen-acetylene torch tip cleaner or tip drill. If the burned-back wire cannot be removed, the tip will have to be replaced.

2. With extended use over time, this hole will become worn. Increased wear on the hole causes increased resistance in the transfer of welding current from the contact tip to the wire. This will result in less stable arc characteristics and difficult arc starting.

CAUTION: KEEP THE NOZZLE CLEAN!

During the welding process, spatter and slag will build up inside the nozzle and must be cleaned out periodically. Failure to clean and/or replace the nozzle in a timely fashion will cause damage to the front end of the gun assembly, which is not replaceable. The results of the inaction may require the replacement of the entire gun assembly.

Failure to keep the nozzle adequately cleaned can result in the following problems:

A shorted nozzle results when spatter buildup bridges across the insulation in the nozzle allowing welding current to flow through it as well as the contact tip. When shorted, a nozzle will steal welding current from the wire whenever it contacts the grounded workpiece. This causes erratic welds and reduced penetration. In addition, a shorted nozzle overheats the end of the gun which can damage the front-end of the gun.



TESTING FOR A SHORTED NOZZLE

Arcing between the nozzle and the workpiece always means the nozzle is shorted, but this can be hard to detect through the lens of a welding helmet. The following testing method is another way to tell if a nozzle is shorted.

With the welder unplugged from the AC power source, touch the probes of an ohmmeter or continuity tester to the end of the contact tip and the outside of the nozzle. If there is any continuity at all, the nozzle is shorted. Clean or replace as needed.

TROUBLESHOOTING

OBSERVE ALL SAFETY GUIDELINES DETAILED THROUGHOUT THIS MANUAL

| PROBLEM | POSSIBLE CAUSE | COURSE OF ACTION |
|--|---|--|
|  | Overheat. | 1. Thermal protector engaged.--Allow welder to cool at least 10 minutes with machine ON. The LED should turn off after the machine has cooled. 2. Insufficient air flow--Check for obstructions blocking air flow and ensure that there are 12 inches of clearance between any obstacles and the vents on all sides of the machine. |
|  | Over Current. | Check the input connection. |
| Frequent circuit breaker Trips. | Machine is drawing too much amperage due to use of larger size electrode. | Use a smaller electrode. |
| | Machine is not the only piece of electrical equipment on the circuit. | Make sure the welder is on a dedicated circuit or is the only thing plugged into a circuit. |
| | Circuit breaker is incorrect/insufficient for use with this machine. | Verify that the circuit breaker for the circuit is a 35A breaker for 110V and 30A for 220V. If it is not, have a qualified electrician install the proper breakers. |
| All LEDs OFF, No output power, Fan not operating. | No input power. | Connect machine to proper input power source. |
| | | Verify that circuit breaker has not been tripped in your main power panel. Reset if needed. |
| | | Wire loose connection. |
| | POWER SWITCH is OFF. | Ensure POWER SWITCH(rear) is on the ON position. |

TROUBLESHOOTING

MIG WELDING ISSUES

| PROBLEM | POSSIBLE CAUSE | COURSE OF ACTION |
|--|---|--|
| No arc or wire feed. Fan operates normally (can be heard). | Gun trigger is not being pulled or is not making contact. | Pull the trigger while in contact with the workpiece. The machine does not arc unless the trigger is pulled. Depress the trigger ALL THE WAY until the trigger stops moving into the gun. |
| | Exceeded duty cycle; thermal protector engaged. | Allow welder to cool at least 10 minutes with machine ON (observe and maintain proper duty cycle). OVERHEAT INDICATOR should turn off after the machine has cooled. |
| | Insufficient air flow causing machine to overheat before reaching duty cycle. | Check for obstructions blocking air flow and ensure that there are 12 inches of clearance between any obstacles and the vents on all sides of the machine. |
| No arc or wire feed. Fan does NOT operate (cannot be heard). | No voltage or incorrect voltage supplied to welder. | Make sure the machine is plugged in. Check the status of your INPUT VOLTAGE INDICATOR LED. It should be illuminated. Check the voltage of your outlet. If it is 10% more or less than optimal, call a qualified electrician. |
| | ON/OFF SWITCH is in the OFF position. | Turn the ON/OFF SWITCH to the ON position. |
| | Circuit breaker has been tripped. | Make sure the circuit breaker has been reset. |
| Feed motor operates but wire will not feed. | Insufficient feed drive roller pressure. | Adjust drive roller pressure. |
| | Burr on end of wire. | Re-cut wire so it is square with no burr. |
| | Liner blocked or damaged. | Clear with compressed air or replace liner. |
| | Despooler tension too high. | Adjust despooler tension. |
| Wire feeds but no arc. | Bad ground or loose ground connection. | Check connection of the ground cable to the work clamp. Tighten cable connection to work clamp if needed. Ensure that the connection between the work clamp and workpiece is good and is on clean, bare (not painted or rusted) metal. |
| | Trigger not pulled while wire is in contact with workpiece. | Pull the trigger while in contact with the workpiece. The machine does not arc unless the trigger is pulled. |
| Poor quality welds. | Insufficient gas at weld area. | Check that the gas is not being blown away by drafts and, if so, move to a more sheltered weld area. If not, check gas cylinder contents, gauge, regulator setting, and operation of gas valve. |
| | Rusty, painted, oily or greasy workpiece | Ensure workpiece is clean and dry. |
| | Poor ground connection or torch/electrode connection. | Check work clamp/workpiece connection and all connections to the machine. |
| | Incorrect settings. | Check welding parameters and polarity. |

TROUBLESHOOTING

MIG WELDING ISSUES

| PROBLEM | POSSIBLE CAUSE | COURSE OF ACTION |
|---|--|---|
| Arc works but not feeding wire. | No pressure on the drive roller; insufficient or excessive pressure on the drive roller. | Adjust the drive pressure. |
| | Wire spool is empty. | Check if wire is in place and replace if necessary. |
| Wire is "bird-nesting" at the drive roller or jamming. | Too much pressure on drive roller. | Adjust the drive pressure. |
| | Contact tip is clogged or damaged. | Replace contact tip. |
| | Worn guides or drive roll alignment. | Replace parts. |
| Low output or non-penetrating weld. | Weld parameters too low. | Adjust welding parameters. |
| | Wrong type or size wire. | Use .030" (0.8mm) - .035" (0.9mm) wire. |
| | Poor ground connection or gun connection. | Reposition clamp and check cable to clamp connection. Check connection of ground cable, gun, and Wire Polarity Drive Lead. |
| | Wrong size or worn contact tip | Use .030" (0.8mm) or 0.035" (0.9mm) contact tip with the corresponding wire. Replace contact tip if worn. |
| | Input power too low. | Have a qualified electrician verify the voltage at your outlet. If the voltage is appropriate, verify that the circuit wiring is sufficient for the circuit breaker size. |
| | Stick out too long. | Decrease stick out (the amount the wire extends past the contact tip). |
| Work clamp, ground cable, and/or welding cable get hot. | Bad ground or loose ground connection. | Check the connection of the work clamp and gun to the machine. Check the connection of the MIG Gun Connection. Check connection of the ground cable to the work clamp. Tighten cable connection to work clamp if needed. Ensure the connection between the work clamp and workpiece is good and on clean, bare (not painted or rusted) metal. Make sure cable is not damaged. |
| Gun nozzle arcs to work surface. | Spatter or Slag build-up inside nozzle or nozzle is clogged. | Clean or replace nozzle as needed. |
| Wire burns back to contact tip. | Wire feed speed is set too low for voltage setting being used. | Increase wire feed speed (turn left knob clockwise). |
| | Stick-out too short. | Increase stick-out (the amount the wire extends past the contact tip). |
| | Wrong size contact tip. | Use correct size contact tip. |
| | Contact tip is clogged or damaged. | Replace contact tip. |

TROUBLESHOOTING

TIG WELDING ISSUES

| PROBLEM | POSSIBLE CAUSE | COURSE OF ACTION |
|-----------------------------|---|--|
| Poor starting. | Poor work clamp connection. | Check and secure work connection. |
| | Start current is too low. | Increase Start current. |
| Black area along weld bead. | Oily or organic contamination on work | Clean work piece. |
| | Tungsten electrode may be contaminated. | Grind to clean electrode. |
| | Leaks in gas line or torch connection. | Check connection. |
| | Gas tank is near empty. | Replace the gas tank. |
| Unstable Arc. | Contaminated base metal. | Remove materials like paint, grease, oil, and dirt, including mill scale from base metal. |
| | Tungsten is contaminated. | Remove 25/64" of contaminated tungsten and re-grind the tungsten. |
| | Arc length too long. | Lower torch so that the tungsten is off of the work piece 5/64"-13/64"(2-5mm). |
| Arc wanders. | Tungsten incorrect or in poor condition. | Check that correct type of tungsten is being used. Remove tungsten 3/4" from the weld end and re-sharpen the tungsten. |
| | Insufficient gas shielding. | Check and set the gas flow between 20-30cfh flow rate. |
| | Contaminated gas or leaks in gas line, torch, or connections. | Check gas line & connections. |
| | Poorly prepared tungsten. | Grind marks should run lengthwise with tungsten, not circular. Use proper grinding method and wheel. |
| | Contaminated base metal. | Remove contaminating materials like paint, grease, oil, and dirt, including mill scale from base metal. |
| | Contaminated/Incorrect filler. | Check the filler wire and remove all grease, oil, or moisture from filler metal. |

TROUBLESHOOTING

TIG WELDING ISSUES

| PROBLEM | POSSIBLE CAUSE | COURSE OF ACTION |
|------------------------------------|---|--|
| Lift TIG does not initiate an arc. | No gas, incorrect gas flow. | Check the gas is connected and cylinder valve open, check hoses, gas valve and torch are not restricted. Set the gas flow between 20-30 cfh flow rate. |
| | Poor work clamp connection. | Check & secure work clamp. |
| | Contaminated Tungsten. | Grind to clean Tungsten. |
| | Loose connection. | Check all connectors and tighten. |
| | Earth clamp not connected to work. | Connect the work clamp directly to the work piece wherever possible. |
| Tungsten burning away quickly. | Incorrect Gas/Inadequate gas flow. | Check the gas cylinder contains pure Argon gas and is connected and the torch gas valve is open. Set the gas flow between 20-30cfh flow rate. |
| | Back cap not fitted correctly. | Make sure the torch back cap is fitted so that the o-ring is inside the torch body. |
| | Incorrect tungsten being used. | Check and change the tungsten type if necessary. |
| Contaminated tungsten. | Touching tungsten into the weld pool. | Keep tungsten from contacting weld puddle. Raise the torch so that the tungsten is off of the work piece 1/8-1/4. |
| | Touching the filler wire to the tungsten. | Keep the filler wire from touching the tungsten during welding, feed the filler wire into the leading edge of the weld pool in front of the tungsten. |
| | Tungsten melting into the weld pool. | Check that correct type of tungsten is being used. Too much current for the tungsten size so reduce the amps or change to a larger tungsten. |

TROUBLESHOOTING

STICK WELDING ISSUES

| PROBLEM | POSSIBLE CAUSE | COURSE OF ACTION |
|--|---|---|
| Poor starting. | Poor work clamp connection. | Check and secure work connection |
| Stick electrode "blasts off" when arc is struck. | Current may be set too high for electrode size. | Adjust current. |
| Electrode "stick" in weld puddle. | Current may be set too low for electrode size. | Adjust current. |
| Porosity – small cavities or holes resulting from gas pockets in weld metal. | Arc length too long. | Reduce arc length. |
| | Damp electrode. | Use dry electrode. |
| | Workpiece dirty. | Remove all grease, oil, moisture, rust, paint, coatings, slag, and dirt from work surface before welding. |
| Excessive Spatter – scattering of molten metal particles that cool to solid form near weld bead. | Amperage too high for electrode. | Decrease amperage or select larger electrode. |
| | Arc length too long or voltage too high. | Reduce arc length or voltage. |
| Incomplete Fusion – failure of weld metal to fuse completely with base metal or a preceding weld bead. | Insufficient heat input. | Increase amperage. Select larger electrode and increase amperage. |
| | Improper welding technique. | Place stringer bead in proper location at joint during welding. |
| | | Adjust work angle or widen groove to access bottom during welding. |
| | | Momentarily hold arc on groove side walls when using weaving technique. |
| | | Keep arc on leading edge of weld puddle. |
| Workpiece dirty. | Remove all grease, oil, moisture, rust, paint, coatings, slag, and dirt from work surface before welding. | |
| Lack Of Penetration – shallow fusion between weld metal and base metal. | Improper joint preparation. | Material too thick. Joint preparation and design must provide access to bottom of groove. |
| | Improper weld technique. | Keep arc on leading edge of weld puddle. |
| | Insufficient heat input. | Increase amperage. Select larger electrode and increase amperage. |
| | | Reduce travel speed. |
| Burn Through – weld metal melting completely through base metal resulting in holes where no metal remains. | Excessive heat input. | Select lower amperage. Use smaller electrode. |
| | | Increase or maintain steady travel speed. |

TROUBLESHOOTING

CUTTING ISSUES

| PROBLEM | POSSIBLE CAUSE | COURSE OF ACTION |
|---|--|---|
| The arc does not transfer to the workpiece. | Insufficient work clamp contact with the workpiece. | Clean the area where the work clamp attaches to the workpiece to ensure a good metal to metal connection. Inspect the work clamp and its lead for damage, repair or replace as necessary. |
| | Improper cutting technique. | 1. Brace the cutting hand to steady cutting hand, provides freedom of movement in all directions and helps maintain a constant 1/16" to 1/8" standoff. 2. Place the torch close and start cut from the edge of the metal with a roll 45-to-90 degree roll in case the sparks blow up into the torch. |
| | Plasma torch may not be in contact with the workpiece. | Be sure to physically drag the cutting nozzle on the workpiece as you cut. |
| Poor cut quality. | Improper use of Plasma torch. | Review operating instructions. |
| | Plasma torch parts are worn out. | Examine the consumables for wear and replace worn parts with new Simder consumable parts. |
| | Moisture or oil in air supply. | Excessive humidity or oil from the compressor may be contaminating the air supply. Install a moisture filter in the air supply line prior to machine. |
| Insufficient cut penetration. | Cutting speed too fast. | Decrease your torch travel speed. |
| | Plasma torch is too tilted. | Ensure that Plasma torch head is perpendicular to the workpiece. |
| | Workpiece is too thick. | Choose thinner workpiece material within the operational limits of the plasma cutting machine. |
| | Cutting current too low. | Turn current setting up. |
| | | Ensure plasma cutting machine has proper input power. |
| | | If used, eliminate or reduce length of extension cord. |
| | Plasma torch parts are worn out. | Examine the consumables for wear and replace worn parts with new Simder consumable parts. |
| Non-genuine manufacturer's parts. | Use only genuine Simder consumables for optimum performance. | |
| Insufficient air flow or pressure. | Check for obstructions blocking air flow and ensure that there are 12 inches of clearance between any obstacles and the vents on all sides of the machine. | |

TROUBLESHOOTING

CUTTING ISSUES

| PROBLEM | POSSIBLE CAUSE | COURSE OF ACTION |
|---|---|---|
| Excessive dross. | Cutting speed too slow (bottom dross). | Increase your torch travel speed. |
| | Cutting speed too fast (top dross). | Decrease your torch travel speed. |
| | Cutting current too low. | Ensure plasma cutting machine has proper input power. |
| | | If used, eliminate or reduce length of extension cord. |
| | Plasma torch parts are worn out. | Examine the consumables for wear and replace worn parts with new Simder consumable parts. |
| Non-genuine manufacturer's parts. | Use only genuine Simder consumables for optimum performance. | |
| Excessive wear of the cutting nozzle or electrode. | Air pressure too low. | Inspect air compressor, air lines, and filters for proper operation. |
| | | Inspect consumables for obstructions and proper installation. |
| | Exceeding plasma cutting machine capability (material too thick). | Choose thinner workpiece material within the operational limits of the plasma cutting machine. |
| | Moisture or oil in air supply. | Excessive humidity or oil from the compressor may be contaminating the air supply. Install a moisture filter in the air supply line prior to machine. |
| | Improperly assembled or loose Plasma torch consumables | Check Plasma torch consumables for proper installation. |
| | Damaged Plasma torch consumable. | Check plasma torch consumables for damage and replace if damaged. |
| Non-genuine manufacturer's parts. | Use only genuine Simder consumables for optimum performance. | |
| Tilted cut edge angle (not perpendicular). | Plasma torch position not correct. | Ensure that plasma torch head is perpendicular to the workpiece. |
| | Workpiece thickness is near the capacity of the machine. | Cut thinner material. 15/32" thick material cuts will not have a clean cut edge. |
| | Asymmetric wear of cutting nozzle hole or wrong assemblage of the plasma torch parts. | Check plasma torch consumables for wear and proper installation. |
| Examine the consumables for wear and replace worn parts with new Simder consumable parts. | | |

SIMDER

WWW.SSIMDER.COM

