

Taurus Series Multimedia Players

V1.6.5



Application Solutions

Contents

Contents.....	i
1 Overview	1
1.1 About This Document.....	1
1.2 Characteristics of the Application Solutions	1
1.3 Software Acquiring Methods	3
2 AD Player and Mirror Screen Solution.....	4
2.1 Overview.....	4
2.2 Single Application.....	5
2.3 Cluster Application	6
2.4 Splicing	10
3 Lamp Post Screen Solution.....	13
3.1 Overview.....	13
3.2 Networking Diagram	14
3.3 Required Software	15
3.4 Required Hardware Devices	15
3.5 Relevant Configuration	15
4 General Operations.....	19
4.1 Taurus Login with ViPlex Handy (Android and iOS)	19
4.2 Taurus Login with ViPlex Express (Windows)	19

1 Overview

1.1 About This Document

Taurus series products are the second-generation multimedia players developed by NovaStar specially designed for full-color LED displays and applicable to all kinds of display devices as well as many application scenes.

AD player, mirror screen and post screen are used here as examples to describe the application solution of Taurus series products. Pictures of Taurus series products used in the networking diagram are taken from T6 model.

For more information on the Taurus series products, please visit www.novastar.tech to download relevant documents.

1.2 Characteristics of the Application Solutions

1.2.1 Synchronous Playing

This function makes several displays play the same image simultaneously with high accuracy based on advanced synchronous playing and scheduling technologies.

The synchronous playing function could be enabled for different displays as long as the following three requirements are met:

- The synchronous playing function has been enabled on the ViPlex or VNNOX.
- The time of multiple Taurus products is synchronized.
- Playing plans of multiple Taurus products are the same without random transition or media.

The advantages of the synchronous playing function are shown in [Table 1-1](#).

Table 1-1 Synchronous playing

Object	Advantage
User	Improve advertisement and information broadcast effects
Environment	Improve city image and make the city more colorful
Display	Improve visual experience

Time could be synchronized through NTP and RF modes from which the user could select one as required:

- NTP time synchronization: Taurus time synchronization is based on the NTP server. No hardware is required to be added, and time synchronization accuracy depends on network speed. Consequently, network traffic will be consumed by using the 4G network.
- RF time synchronization: Master and slave devices are required to be set for Taurus. The time of the slave device is synchronized with that of the master device through an RF signal, and therefore RF device is required. This time synchronization method is applicable to events with high time synchronization

requirements and does not consume network traffic, but its signal receiving depends on the environment and is limited by distance.

1.2.2 Smart Brightness Adjustment

Smart brightness adjustment includes auto brightness adjustment and timing brightness adjustment.

- Auto brightness adjustment: Display brightness will automatically adjust according to environment brightness.
- Timing brightness adjustment: Display brightness will automatically adjust to a specific value at a given point of time.

Taurus products have brightness sensor connectors. Connect the light sensor and set smart brightness adjustment rules on ViPlex or VNNOX to enable the smart brightness adjustment function.

The advantages of smart brightness adjustment are as shown in [Table 1-2](#).

Table 1-2 Smart brightness adjustment

Object	Advantage
User	Reduce manual operations
Environment	Avoid light pollution
Display	Smarter

Taurus products support manual brightness adjustment as well.

1.2.3 4G Module

Some Taurus series product models support 4G modules. To connect the Taurus to the Internet via 4G network, buy the corresponding 4G module and install it according to the country or region of the service provider.

The Taurus can be connected to the Internet through the following three methods listed from the highest to the lowest priority:

- Wired network
- Wi-Fi network
- 4G network

When the three methods are all enabled, the Taurus will select signals automatically according to the priorities.

When the mobile data network is enabled on ViPlex and priority requirements for signal selection are met, Taurus products with 4G modules could connect to the Internet via 4G network.

The advantages of 4G module are as shown in [Table 1-3](#).

Table 1-3 4G module

Object	Advantage
User	Solution transmission speed is fast without wiring operation
Environment	-
Display	All Internet connection methods are available to enable more application scenes

1.2.4 Cluster Management

Display quantity increases fast with the development of smart cities and commercial applications, and the cluster solution of NovaStar emerges to uniformly manage and monitor numerous displays in different places.

The advantages of cluster management are as shown in Table 1-4.

Table 1-4 Cluster management

Object	Advantage
User	Remotely and uniformly manage and monitor numerous displays
Environment	Helpful for the development of the smart city
Display	Without limits on deployment position and quantity

1.3 Software Acquiring Methods

Table 1-5 Related software

Name	Type	Description	Address
ViPlex Handy	Mobile client	Screen management software for Android phones and iPhones, which is mainly used for screen management, solution editing and publishing.	
ViPlex Express	PC client	LAN-based screen management software for Windows, which is mainly used for screen management, solution editing and publishing.	https://www.vnnox.com/download?!=en
VNNOX	Online software	One-stop cloud platform, which is mainly used for remote content publishing and device management.	www.en.vnnox.com

2 AD Player and Mirror Screen Solution

2.1 Overview

AD player and mirror screen, the typical commercial display applications, are mainly used for information publishing and advertisement display, and can be placed at the shopping mall, hotel, office building, exhibition, bank, station and community.

There are two application modes for the mirror screen which is a mirror when the display is turned off.

There are many application modes for the AD player and mirror screen, and only typical applications are introduced in this chapter, including the single application, cluster application and splicing application.

Characteristics of the AD player and mirror screen of NovaStar are as shown in [Table 2-1](#).

Table 2-1 AD player and mirror screen

Characteristic	Description	Required Configuration
Support for synchronous display	Application of advanced synchronous playing and dispatching technologies realize high-accuracy synchronous playing for the same image on different displays.	<ul style="list-style-type: none"> • Enable the synchronous playing function on the ViPlex or VNNOX. • Set time synchronizing rules on the ViPlex or VNNOX.
Support for smart brightness adjustment	Automatic and timing brightness adjustment could reduce manual operation, and brightness filtering technology could help to avoid brightness interference to realize stable display brightness.	Set smart brightness adjustment rules on ViPlex or VNNOX.
Support for splicing playing	Both individual playing and splicing playing are available for multiple displays.	Set splicing-related parameters on ViPlex.
Support for selling advertisements played in different time periods	During the process of solution scheduling, the user can divide time periods as required to play the specified list in every time period.	Edit solutions on ViPlex or VNNOX.
Support for media switching without blackout	Blackout does not occur during media switching process.	No need to set.
Support for generating play log	The Taurus products can generate play logs, and the user can check and export the logs in VNNOX.	No need to set.

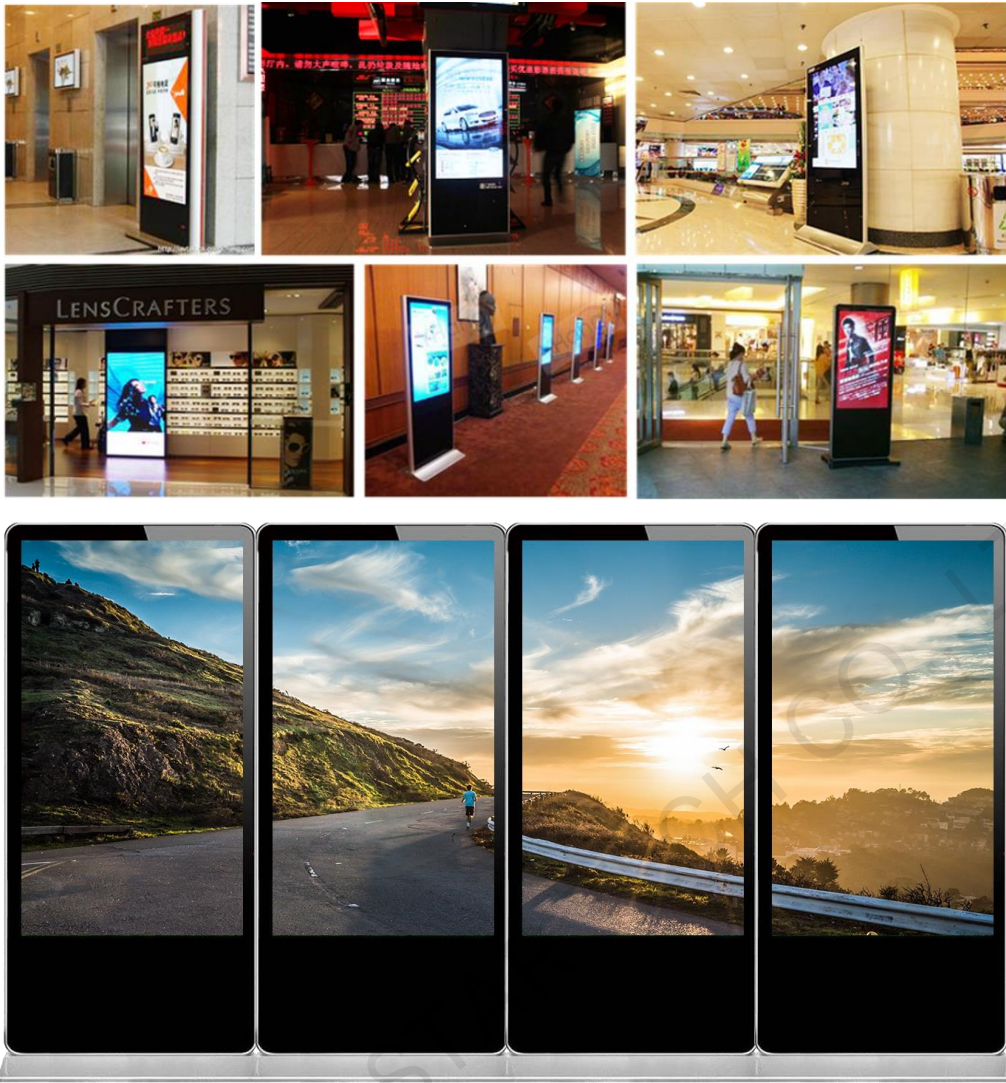

2.2 Single Application

2.2.1 Networking Diagram

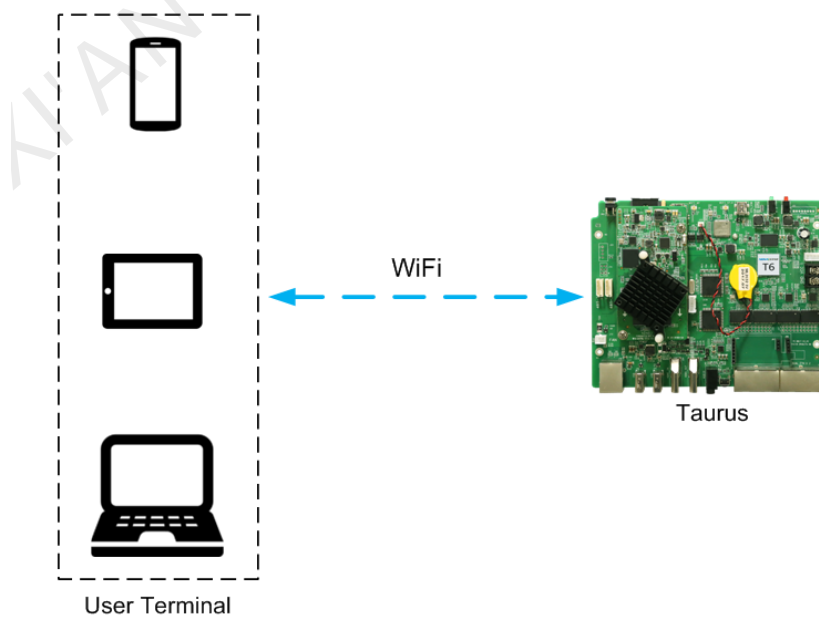

Taurus products provide Wi-Fi AP itself. After connecting to Wi-Fi AP with PC, Pad and mobile phone, enter the username and password to log in to the Taurus.

2.2.2 Required Software

- ViPlex Handy
- ViPlex Express

2.2.3 Relevant Configurations

No need to set. Refer to [4 General Operations](#) for specific operations to connect and log in to the Taurus products.

2.3 Cluster Application

2.3.1 Networking Diagram

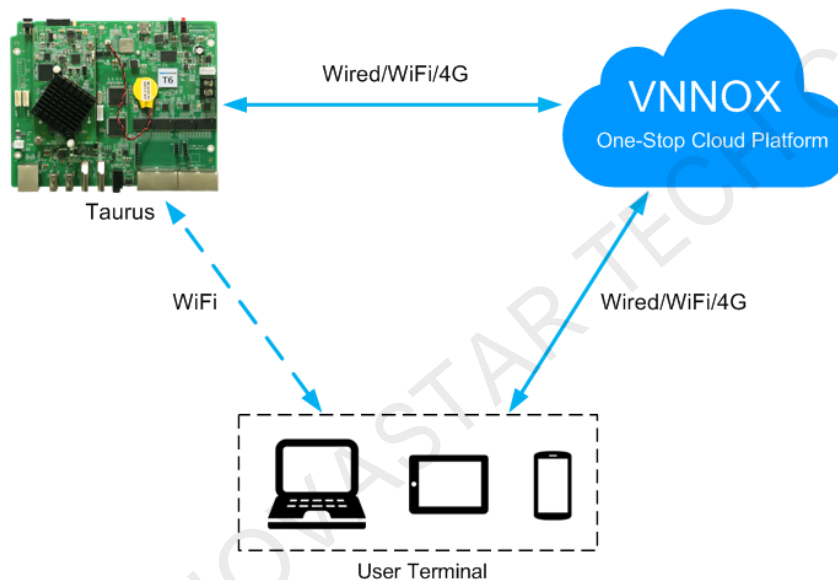

VNNOX could be accessed directly or by way of bridge connection. When bridge connection is selected, the following three methods for Internet connection of Taurus products are available with priorities ranging from high to low:

- Wired network
- Wi-Fi network
- 4G network

When the three methods are all enabled, Taurus products will select signals automatically according to the priorities.

2.3.2 Required Software

- ViPlex Handy
- ViPlex Express
- VNNOX

2.3.3 Required Hardware Devices

Function	Required Hardware Device	Model
Synchronous playing	When RF time synchronization is used, it is required to purchase RF devices	E32-433T30D-NW
Smart brightness adjustment	Light sensor	NS048D

2.3.4 Relevant Configurations

Before You Begin

- The login username and password for VNNOX and NovaLCT are acquired.
- Create a solution(s) on VNNOX without random transition and random media of the solution(s).
- Configurations required before monitoring have been done on NovaLCT and VNNOX.

Refer to software online help for specific operations of VNNOX and NovaLCT.

Acquiring Player Authentication Information

The authentication information is required when you bind VNNOX to the Taurus through ViPlex.

Step 1 Visit www.en.vnnox.com and log in to VNNOX.

Step 2 On the homepage of the cloud platform, choose  > **Player Authentication**.



Step 3 In the **VNNOX Standard/AD Authentication Information** area, view **Server Address**, **Authentication User Name**, and **Authentication Password**.

Configuring ViPlex Handy (Android and iOS)

Step 1 Log in to the Taurus. Refer to 4.1 [Taurus Login with ViPlex Handy \(Android and iOS\)](#).

Step 2 Tap the device name to enter the **Device Management** page.

Step 3 Set rules for smart brightness adjustment.

1. Choose **Screen Settings** > **Brightness Control**.
2. Tap **Brightness Mode**, select **Smart**, and tap **OK**.
3. Tap **Smart Brightness Adjustment Table**.
4. Tap  to set rules for scheduled brightness adjustment, then tap **OK**.
5. Tap  to set rules for automatic brightness adjustment, then tap **OK**.
6. Tap **Auto Brightness Adjustment Parameters** to set the corresponding relation between ambient brightness and screen brightness, then tap **Done**.
7. Tap **OK**.

Step 4 Set the connection method between the Internet and Taurus.

Priorities of the wired network, Wi-Fi Sta and 4G network range from high to low. When the three methods are all enabled, the Taurus will select signals automatically according to the priorities.

- Wired network: When a static IP address is required, choose **Network Settings > Wired Network Settings**, turn **DHCP** off, enter the static IP address of the Taurus, and tap **Done**.
- Wi-Fi Sta: Choose **Network Settings > Wireless Network Settings**, and turn **Wi-Fi** on. Click the Wi-Fi name of the external router and enter the Wi-Fi password, and tap **OK**.
- 4G network: Choose **Network Settings > Mobile Data Settings**, and turn **Mobile Data** on.

Step 5 Bind to VNNOX Standard/AD.

1. Choose **Remote Management > VNNOX Standard/AD**.
2. Set the server and player authentication information.
3. Tap **Next**.
4. Tap **Done**.

Step 6 If binding iCare is required, perform the following procedures. Otherwise, ignore this step.

1. Choose **Remote Management > iCare**.
2. Select a server.
3. Tap **Next**.
4. Enter the user name for logging in to iCare.
5. Tap **Done**.

Step 7 Repeat the above steps to configure other Taurus products in the cluster till all Taurus products have been configured.

Configuring ViPlex Express (Windows)

Step 1 Log in to the Taurus and see detailed operations in [4.2 Taurus Login with ViPlex Express \(Windows\)](#).

Step 2 Select **Terminal Control**.

Step 3 Set rules for smart brightness adjustment.

1. Select Brightness adjustment.
2. Select the target terminal in the terminal list.
3. Click  on the **Smart** page.
4. Set rules for timed brightness adjustment and click **Add**.
5. Set rules for auto brightness adjustment and click **Add**.
6. Click **Close**.
7. Click **Apply**.

Step 4 Set the way to connect Taurus to the Internet.

The priority of wired network, Wi-Fi network and 4G network is from high to low. If all of the three ways are enabled, the Taurus will choose a signal automatically according to the priority order.

1. Select Network configuration.
2. Select the target terminal in the terminal list and perform the following operations according to actual needs.
 - Wired network: If it is required to set a static IP address, deselect **DHCP**, enter the IP address information of the Taurus and then click **Apply** in the **Wired network configuration** section.

- Wi-Fi network: Turn on **Wi-Fi** in the **Wi-Fi Configuration** section. Double click the Wi-Fi name of the external router and then enter the Wi-Fi password and click **OK**.
- 4G network: In the **Mobile Network Configuration** area, turn on the mobile network.

Step 5 Bind to VNNOX Standard/AD.

1. Select Server configuration.
2. Select the target terminal in the terminal list.
3. In **Bind to VNNOX Standard/AD**, select a server and enter the authentication user name, authentication password and player name.
4. Click **Bind**.

Step 6 If binding iCare is required, perform the following procedures. Otherwise, ignore this step.

1. In **Bind to iCare**, select a server and enter the login user name.
2. Click **Bind**.

Step 7 Repeat the above steps until all the Taurus products in the cluster are configured.

Configuring VNNOX

When setting timing rules and synchronous playing upon ViPlex, every Taurus product is required to be set individually, and batch setting is available for setting timing rules and synchronous playing upon VNNOX. When the public network is available, VNNOX is recommended for batch configuration to reduce manual operations.

Step 1 Visit www.en.vnnox.com and log in to VNNOX AD.

Step 2 Set time synchronization rule.

1. Choose  > **Players Management** > **Time Synchronization**.
2. Click **NTP server configuration**.
3. Configure NTP information, and then click **Save&Close**.
4. Click **New** on the page of the time synchronization task list.
5. Enter a time synchronization task name and select a time synchronization method, and then click **Next**.
 - **NTP**: Select an NTP server and then click **OK**.
 - **RF**: Select a time synchronization standard device and then click **OK**.
6. Click **Add** in the **Players** tab of the time synchronization task attribute page.
 - NTP time synchronization: Select all the players in the cluster and then click **OK**.
 - RF time synchronization: Select all the slave players in the RF network and then click **OK**.
7. When the time synchronization method upon RF network is selected, and NTP server is used for the time synchronization standard device, click **Configure** tab to set **NTP** to **Yes**, and select NTP server. Otherwise, ignore this step.
8. Click **Save** or **Save&Close**. Players added in the time synchronization task will perform time synchronization according to rules defined in the task.

Step 3 If the same image is required to be played by different screens, perform the following procedures. Otherwise, ignore this step.

1. Choose  > **Players Management** > **Players**.
2. Select asynchronous players corresponding to all Taurus series products requiring enabling the synchronous playing function.
3. Choose **Real-time control** > **Synchronous playback** > **Turn on sync play**.

Step 4 Associate with a solution(s).

1. Choose  > **Players Management** > **Players**.
2. Select a player and click **Attribute**, or click a player name.
3. Select a solution from the drop-down box of parameter **associate solution**.
4. Perform the corresponding operation below according to the solution distribution type.
 - Manual: Click **Save&Close** to return to the player list page. Perform term 5.
 - Auto: Click **Save** or **Save&Close**. VNNOX will automatically distribute the solution to corresponding Taurus products.
 - Scheduled: Set the **Solution update time**, and click **Save** or **Save&Close**. VNNOX will distribute the solution to corresponding Taurus products at the solution update time.
5. Select the target player, and click **Update solution** to distribute solutions to corresponding Taurus products manually.
6. Repeat the above steps to associate with solutions for other players in the cluster till all players have been configured.

2.4 Splicing

This section will show you an example of splicing three displays horizontally from left to right and using the external video source.

2.4.1 Networking Diagram

The following figure uses three displays splicing as an example to illustrate the Taurus connection.

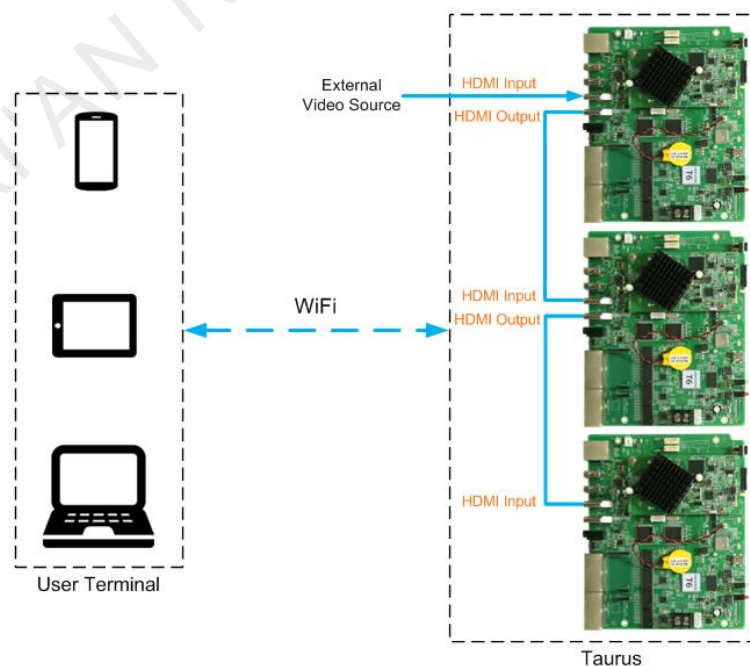

The Taurus product provides Wi-Fi AP itself. Connect to Wi-Fi AP of each Taurus product through PC, Pad and mobile phone, and then enter the username and password to log in to the Taurus.

2.4.2 Required Software

- ViPlex Handy
- ViPlex Express

2.4.3 Relevant Configuration

Before You Begin

Make sure that the displays have the same specifications.

Configuring ViPlex Handy (Android and iOS)

- Step 1 Log in to all the Taurus to be spliced. Refer to [4.1 Taurus Login with ViPlex Handy \(Android and iOS\)](#) for specific operations.
- Step 2 Choose **Me > Select Mode**.
- Step 3 Select **Screen Configuration Mode**, and tap **OK**.
- Step 4 Choose **Local Devices**.
- Step 5 On the **Local Devices** page, tap  at the top right.
- Step 6 Enter a resolution and click **Query** to search for screens.

The online local Taurus and offline Taurus with mosaic order that match your query will be displayed.

- Step 7 (Optional) Click  to sort the Taurus with mosaic order by ascending mosaic order.
- Step 8 Tap **Mosaic**.
- Step 9 Set the number of screens used for mosaic.

The number of screens cannot be greater than the ceiling integer of the value of "video source width/loading capacity width of the Taurus".

The loading capacity width of the Taurus is up to 4096 pixels.

- Step 10 Set mosaic orders.

The system sets the horizontal offset of the image automatically according to the mosaic order and the loading capacity width of the Taurus.

Offset = (*Mosaic order*-1) × Loading capacity width of the Taurus

For example, if the loading capacity width of the Taurus is 500 px, set the offset of the second screen to 500 px and the third screen to 1000 px.

- Step 11 Set the video source of the first screen.

Configuring ViPlex Express (Windows)

- Step 1 Log in to the Taurus and see detailed operations in [4.2 Taurus Login with ViPlex Express \(Windows\)](#).
- Step 2 Choose **Terminal Control > Video source**.
- Step 3 Select the target terminal in the terminal list.
- Step 4 On the **Manual** page, configure all required parameters.

- **Video Source Type:** HDMI

- **X:** (*Mosaic order* - 1) × Loading capacity width of the Taurus. For example, if the loading capacity width of the Taurus is 500 px, set the offset of the second screen to 500 px and the third screen to 1000 px.
- **Y:** 0

If the first display uses the internal video source, set the **Video Source Type** of the first display to **Internal source** and set the **Video Source Type** of other displays to **HDMI**.

Step 5 Click **Apply**.

Step 6 Repeat the above steps to configure other Taurus products till all Taurus products have been configured.

XI'AN NOVASTAR TECH CO., LTD

3 Lamp Post Screen Solution

3.1 Overview

Lamppost screens prevail on both sides of highways and roads with the development of the smart city. Smart lamp post screen has distinct advantages compared with the conventional lamp post which features illumination and static advertisement only and requires new manufacture and installation in case of advertisement replacement, while the smart lamp post provides functions including illumination, security monitoring, environment monitoring, emergency call, charging pile and LED display which used high-definition smart lamp post LED screen for road leading, data release and advertising promotion.

Lamppost screens can be used without quantity limits, and the display contents can be controlled individually or in batches based on the cluster management method.

Characteristics of the post screen of NovaStar are as shown in [Table 3-1](#).

Table 3-1 Lamppost screens

Characteristics	Description	Require Configuration
Support synchronous playing	Use advanced synchronous playing and scheduling technologies to make several displays play the same image at the same.	<ul style="list-style-type: none"> • Enable the synchronous playing function on the ViPlex or VNNOX. • Set time synchronizing rules on the ViPlex or VNNOX.
Support for smart brightness adjustment	Automatic and scheduled brightness adjustment can reduce manual operation, <ul style="list-style-type: none"> • Can connect to light sensors to implement smart screen brightness adjustment. • Can avoid interference in screen brightness and make the screen brightness more stable by using brightness filtering. 	Set smart brightness adjustment rules on ViPlex or VNNOX.
Support for selling advertisements played in different time periods	During the process of solution scheduling, the user can divide time periods as required to play the specified list in every time period.	Edit solutions on ViPlex or VNNOX.
Support for media switching without blackout	Blackout does not occur during media switching process.	No need to set.
Support for generating play log	Taurus products can generate play logs, and the user can check and export the log on VNNOX.	No need to set.
Support for remote solution publishing	VNNOX is a one-stop cloud platform which is mainly used for remote content publishing and device	Visit www.en.vnnox.com for register and login.

Characteristics	Description	Require Configuration
	management.	
Support for environment monitoring	Working with the router, the camera can implement environment monitoring.	Configure the router.
Support for 4G module	After the 4G module is installed, the Internet can be connected via 4G network.	Turn on mobile data network on ViPlex.



3.2 Networking Diagram

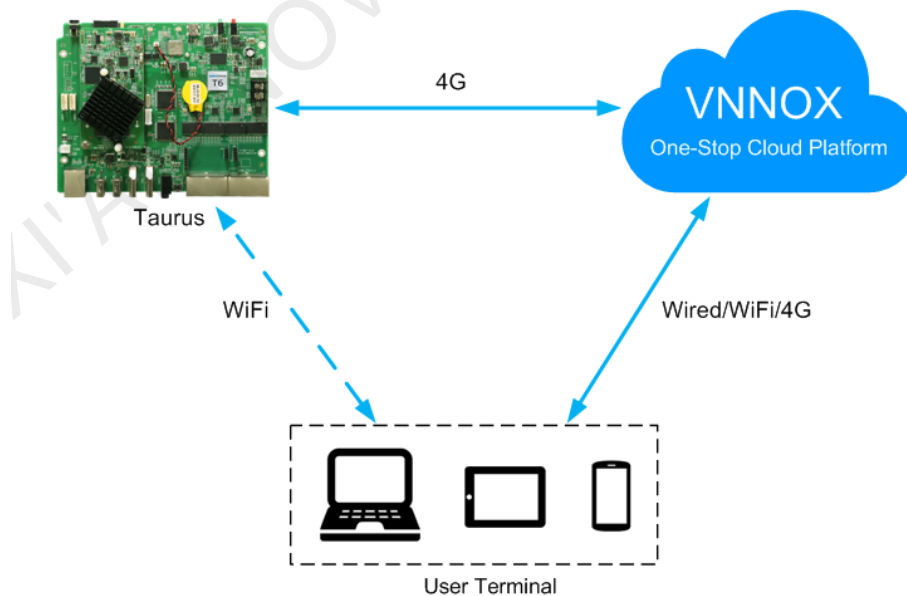

VVNOX could be accessed directly or by way of bridge connection to centrally manage post screens.

Taurus products can connect to the Internet through the wired network, Wi-Fi and 4G network which is recommended for this solution.

3.3 Required Software

- ViPlex Handy
- ViPlex Express
- VNNOX

3.4 Required Hardware Devices

Function	Required Hardware Device	Model
Synchronous playing	When RF time synchronization is used, it is required to purchase RF devices	E32-433T30D-NW
Smart brightness adjustment	Light sensor	NS048D

3.5 Relevant Configuration

Before You Begin

- Acquire the login username and password of VNNOX and NovaLCT.
- Create a solution on the VNNOX without random transition and random media.
- Create an asynchronous player which associates with License on the VNNOX.
- Complete configurations required to be done before monitor on NovaLCT and VNNOX.

Refer to software online help for specific operations of VNNOX and NovaLCT.

Acquiring player Authentication Information

The authentication information is required when you bind asynchronous players on VNNOX to the Taurus through ViPlex.

Step 1 Visit www.en.vnnox.com and log in to VNNOX.

Step 2 On the homepage of the cloud platform, choose  > **Player Authentication**.

Step 3 In the **VNNOX Standard/AD Authentication Information** area, view **Server Address**, **Authentication User Name**, and **Authentication Password**.

Configuring ViPlex Handy (Android and iOS)

Step 1 Log in to the Taurus. Refer to 4.1 [Taurus Login with ViPlex Handy \(Android and iOS\)](#) for specific operations.

Step 2 Tap the device name to enter the **Device Management** page.

Step 3 Set rules for smart brightness adjustment.

1. Choose **Screen Settings > Brightness Control**.
2. Tap **Brightness Mode** to select **Smart**, and then tap **OK**.
3. Tap **Smart Brightness Adjustment Table**.
4. Tap  to set rules for scheduled brightness adjustment, then tap **OK**.

5. Tap  to set rules for automatic brightness adjustment, then tap **OK**.
 6. Tap **Auto Brightness Adjustment Parameters** to set the corresponding relation between ambient brightness and screen brightness, then tap **Done**.
 7. Tap **Done**.
- Step 4 Set Internet connection mode for the Taurus.
1. Choose **Network Settings > Mobile Data Settings**.
 2. Turn **Mobile Data** on.
- Step 5 Bind to VNNOX.
1. Choose **Remote Management > VNNOX Standard/AD**.
 2. Set the server and player authentication information.
 3. Tap **Next**.
 4. Tap **Done**.
- Step 6 If binding iCare is required, perform the following procedures. Otherwise, ignore this step.
1. Choose **Remote Management > iCare**.
 2. Select a server.
 3. Tap **Next**.
 4. Enter the user name for login iCare.
 5. Tap **Done**.
- Step 7 Repeat the above steps to configure other Taurus products in the cluster till all Taurus products have been configured.

Configuring ViPlex Express (Windows)

- Step 1 Log in to the Taurus and see detailed operations in 4.2 [Taurus Login with ViPlex Express \(Windows\)](#).
- Step 2 Select **Terminal Control**.
- Step 3 Set rules for smart brightness adjustment.
1. Select **Brightness adjustment**.
 2. Select the target terminal in the terminal list.
 3. Click  on the **Smart** page.
 4. Set rules for timed brightness adjustment and click **Add**.
 5. Set rules for auto brightness adjustment and click **Add**.
 6. Click **Close**.
 7. Click **Apply**.
- Step 4 Set the way to connect Taurus to the Internet.
1. Select **Network configuration**.
 2. Select the target terminal in the terminal list.
 3. In the **Mobile Network Configuration** area, turn on mobile network.

Step 5 Bind to VNNOX Standard/AD.

1. Select Server configuration.
2. Select the target terminal in the terminal list.
3. In **Bind to VNNOX Standard/AD**, select a server and enter the authentication user name, authentication password and player name.
4. Click **Bind**.

Step 6 If binding iCare is required, perform the following procedures. Otherwise, ignore this step.

1. In **Bind to iCare**, select a server and enter the login user name.
2. Click **Bind**.

Step 7 Repeat the above steps until all the Taurus products in the cluster are configured.

Configuring VNNOX

When setting timing rules and synchronous playing upon ViPlex, every Taurus product is required to be set individually, and batch setting is available for setting timing rules and synchronous playing upon VNNOX. When the public network is available, VNNOX is recommended for batch configuration to reduce manual operations.

Step 1 Visit www.en.vnnox.com and log in to VNNOX AD.

Step 2 Set time synchronization mode.

1. Choose  > **Players Management** > **Time Synchronization**.
2. Click NTP server configuration.
3. Configure NTP service information, and then click **Save&Close**.
4. Click **New** on the page of time synchronization task list.
5. Enter a time synchronization task name and select a time synchronization method, and then click **Next**.
 - **NTP**: Select the NTP server and then click **OK**.
 - **RF**: Select a time synchronization standard device and then click **OK**.
6. Click **Add** in the **Players** tab of the time synchronization task attribute page.
 - NTP time synchronization: Click all the players in the cluster and then click **OK**.
 - RF time synchronization: Click all the slave players in RF network and then click **OK**.
7. When the time synchronization method upon RF network is selected, and NTP server is used for the time synchronization standard device, click **Configure** tab to set **NTP** to **Yes**, and select NTP server. Otherwise, ignore this step.
8. Click **Save** or **Save&Close**. Players added in the time synchronization task will perform time synchronization according to rules defined in the task.

Step 3 If the same image is required to be played by different screens, perform the following procedures. Otherwise, ignore this step.

1. Choose  > **Players Management** > **Players**.
2. Select asynchronous players corresponding to all Taurus series products requiring enabling the synchronous playing function.
3. Choose Real-time control > Synchronous playback > Turn on sync play.

Step 4 Associate with a solution(s).

1. Choose  > **Players Management** > **Players**.
2. Select a player and click **Attribute**, or click a player name.
3. Select a solution from the drop-down box of parameter **associate solution**.
4. Perform the corresponding operation below according to the solution distribution type.
 - Manual: Click **Save&Close** to return to the player list page. Perform term 5.
 - Auto: Click **Save** or **Save&Close**. VNNOX will automatically distribute solutions to corresponding Taurus products.
 - Scheduled: Set the **Solution update time**, and click **Save** or **Save&Close**. VNNOX will distribute the solution to corresponding Taurus products at the solution update time.
5. Select the target player, and click **Update solution** to distribute solutions to corresponding Taurus products manually.
6. Repeat the above steps to associate with solutions for other players in the cluster till all players have been configured.

4 General Operations

The Taurus series products are designed with permanent Wi-Fi AP. This chapter takes Wi-Fi AP connection as an example to introduce the Taurus login method.

Other connection methods require hardware or software configuration. Refer to **Taurus Series Multimedia Players Quick Start Guide** for specific operations.

4.1 Taurus Login with ViPlex Handy (Android and iOS)

Before You Begin



- Get the SSID and password of the Wi-Fi AP of the Taurus. The default SSID is “**AP+the last 8 digits**”. The default password is “**12345678**”.
- Get the password of the user “**admin**”. The default password of the user “**admin**” is “**123456**”.

Operating Procedure

Step 1 Connect the Wi-Fi AP of the Taurus products.

Step 2 Open ViPlex Handy.

ViPlex Handy automatically detects the Taurus and refreshes the local device list. Users can also swipe down to manually refresh the local device list.

- : Denotes that the Taurus is online and you can log in to it. Go to [Step 3](#).
- : Denotes that Taurus is offline and you cannot log into it.

Step 3 Tap **Connect** next to the device name.

Step 4 Enter the password for the "admin" user and then tap **OK**.

After successful login,  is displayed. ViPlex Handy saves the account information automatically.

4.2 Taurus Login with ViPlex Express (Windows)

Before You Begin

- Get the SSID and password of Wi-Fi AP of the Taurus. The default SSID is “**AP+the last 8 digits**”. The default password is “**12345678**”.
- Get the password of the user “**admin**”. The default password of the user “**admin**” is “**123456**”.



Operating Procedure

Step 1 Connect the Wi-Fi AP of the Taurus products.

Step 2 Open ViPlex Express.

Step 3 Click **Refresh** to refresh the screen list.

After detecting the Taurus, ViPlex Express will try to log in to the Taurus with the default account or the account used for the last login.

-  : Denotes that the Taurus is online and you can log in to it. Go to [Step 4](#).
-  : Denotes the Taurus is offline and you cannot log in to it.
-  : Denotes logging into the Taurus is successful.

Step 4 Click **Connect** next to the screen information.

Step 5 Enter the password for the "admin" user and then click **OK**.

After successful login, ViPlex Express saves the account information automatically.

XI'AN NOVASTAR TECH CO., LTD

Copyright © 2021 Xi'an NovaStar Tech Co., Ltd. All Rights Reserved.

No part of this document may be copied, reproduced, extracted or transmitted in any form or by any means without the prior written consent of Xi'an NovaStar Tech Co., Ltd.

Trademark

NOVA STAR is a trademark of Xi'an NovaStar Tech Co., Ltd.

Statement

Thank you for choosing NovaStar's product. This document is intended to help you understand and use the product. For accuracy and reliability, NovaStar may make improvements and/or changes to this document at any time and without notice. If you experience any problems in use or have any suggestions, please contact us via the contact information given in this document. We will do our best to solve any issues, as well as evaluate and implement any suggestions.

| [Official website](http://www.novastar.tech)
| www.novastar.tech

| [Technical support](mailto:support@novastar.tech)
| support@novastar.tech