

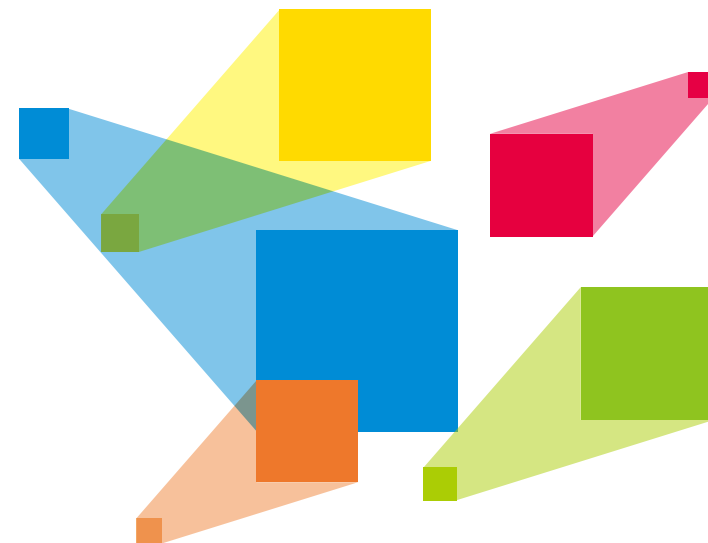

NovaPro UHD Jr

All-in-One Controller



Quick Start Guide

1

Introduction

The NovaPro UHD Jr is NovaStar's all-in-one controller that integrates video processing with sending card functions.

The NovaPro UHD Jr features multiple input connectors, supporting up to 8 inputs simultaneously, and multiple output connectors, including 16 Ethernet ports and 4 optical fiber ports. Thanks to 4Kx2K@60Hz ultra high-definition inputs and outputs, 8Kx1K@60Hz ultra-high resolution settings, excellent video signal processing capabilities and large loading capacity, the NovaPro UHD Jr is well suited for stage control systems, conference sites, activities, exhibition sites and other high-end rental applications as well as fine-pitch LED displays.



Connect to PC for debugging.

PIP: Enter the layer settings screen.
SCALE: Enable/Disable the scaling function of bottom layer.
DVI MOSAIC: Switch to DVI mosaic input source.
FN: This is a custom function button.

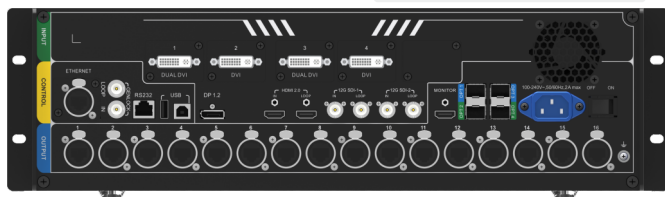

Input		
Connector	Qty	Description
DVI	4	- Four DVIs are all single-link DVI connectors by default. Each DVI: Input resolution up to 1920x1200@60Hz, downward compatible Four single-link DVI input sources constitute one input source (DVI MOSAIC). - In dual-link mode, DVI 1 and DVI 3 are dual-link DVI connectors while DVI 2 and DVI 4 are unavailable. DVI 1/DVI 3: Input resolution up to 3840x1080@60Hz, downward compatible Maximum resolution supported: Max. width: 2048. Max. height: 2048

Input		
Connector	Qty	Description
12G-SDI	2	Input resolution up to 4096x2160@60Hz, downward compatible, loop output Maximum resolution supported: Max. width: 8192. Max. height: 8192
DP 1.2	1	Input resolution up to 3840x2160@60Hz, downward compatible, HDCP 1.3 compliant Maximum resolution supported: Max. width: 8192. Max. height: 8192
HDMI 2.0	1	Input resolution up to 3840x2160@60Hz, downward compatible, loop output, HDCP 2.2 and EDID management Maximum resolution supported: Max. width: 8192. Max. height: 8192

Output		
Connector	Qty	Description
Ethernet port	16	16 x Neutrik Gigabit Ethernet output connectors, allowing for a loading capacity up to 10,400,000 pixels Maximum resolution supported: Max. width: 16K. Max. height: 8K
OPT 1-4	4	10G optical outputs In fiber converter mode, used as input connectors In video controller mode, used as output connectors - OPT 1 transmits data of Ethernet ports 1-8. - OPT 2 transmits data of Ethernet ports 9-16. - OPT 3 serves as the copy/hot backup for OPT 1. - OPT 4 serves as the copy/hot backup for OPT 2.
MONITOR	1	HDMI connector for output monitoring Resolution up to 1920x1080@60Hz

Control		
Connector	Qty	Description
ETHERNET	1	Connect to the PC for communication, or to the Web for device control.
USB-B	1	Connect to the PC for device control. Used as the input connector to connect a NovaPro UHD Jr unit for image mosaic
USB-A	1	Used as the output connector to connect a NovaPro UHD Jr unit for image mosaic
GENLOCK IN-LOOP	1	Connect to a synchronization signal to synchronize all the connected NovaPro UHD Jr units.
RS232	1	Connect to the control device.

2

Applications

1 NovaPro UHD Jr unit for image mosaic

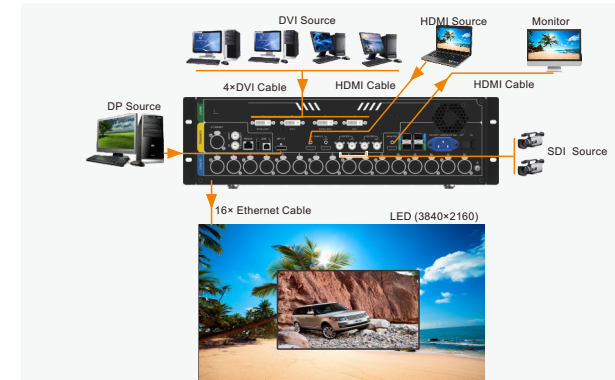

4 NovaPro UHD Jr units for image mosaic

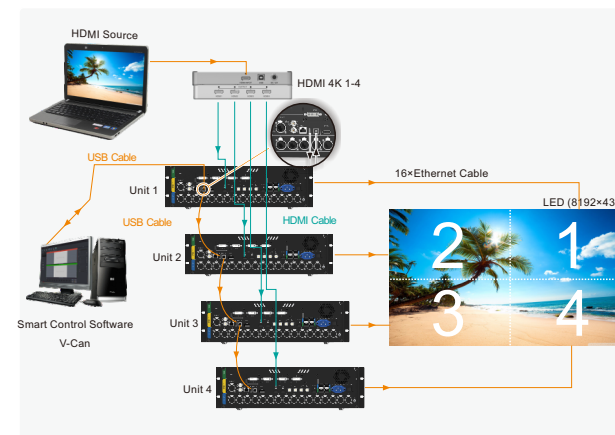

DVI MOSAIC - 1 x input source: 3840x2160@60Hz

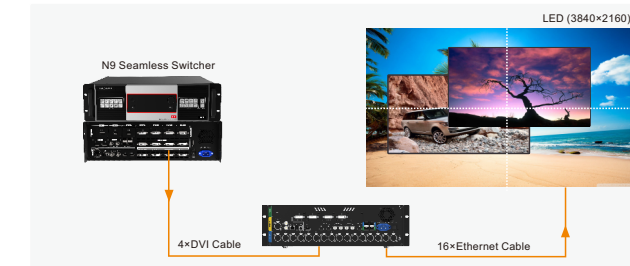

DVI MOSAIC - 4 x input source: 1920x1080@60Hz

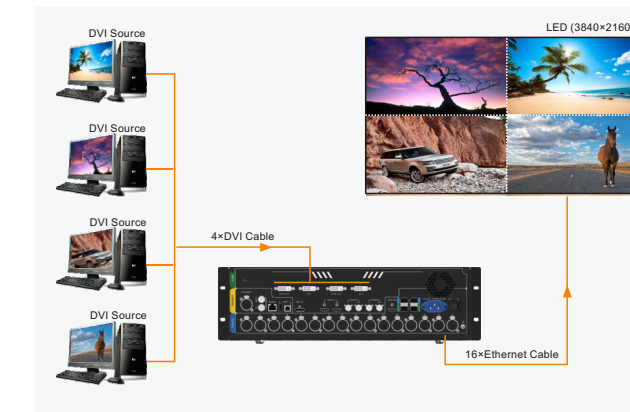

3

Operations

Basic operations of the NovaPro UHD Jr includes configuring screens, adding layers and selecting input sources.

Quick Configuration

Preconditions

- LED screen must be a regular screen.
- Cabinets of the screen must be regular cabinets with the same resolution.
- The following data flow settings are supported. During data flow settings, you must ensure that the physical connection of each port is along the same direction and downward to next one.



- During data flow settings, you must ensure that the Ethernet Port 1 is at the beginning position of the whole physical connection.

Procedure

- Power on the LED screen.
- On the home screen, press the knob to enter the main menu screen. Then rotate the knob to choose **Screen Settings > Quick Configuration** to enter the quick configuration screen.
- Set **Cabinet Row Qty** and **Cabinet Column Qty** according to the actual row and column quantities of the cabinets.

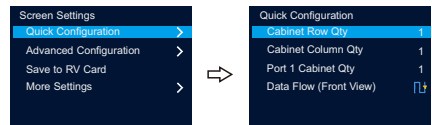

- Rotate the knob to select **Port 1 Cabinet Qty** to set the quantity of the cabinets loaded by Ethernet port 1.



Note

- The quantities of the cabinets loaded by Ethernet ports 1-15 must be the same.
- The quantity of cabinets loaded by each Ethernet port must be an integer multiple of Cabinet Row Qty or Cabinet Column Qty of the screen.

- Rotate the knob to select **Data Flow (Front View)** and press it, then select an appropriate physical connection mode of the cabinets. During data flow settings, you can view the real-time effects of different data flow settings on LED display by rotating the knob. When you are satisfied with the LED display image, press the knob to save the settings.
- Press **ESC** button to exit the quick configuration screen.
- Rotate the knob to select **Save to RV Card** and press the knob to send and save the screen configuration file to the hardware.

Adding Layers

- Rotate the knob to select **Main Layer > Status > On** to add the main layer. The main layer is added by default.
- Rotate the knob to select **Input Source** and select the desired input source based on your actual needs.

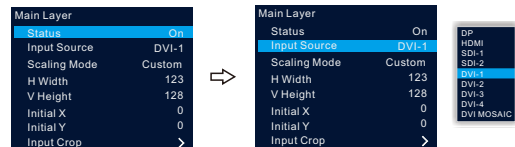

Image Mosaic

When 4 NovaPro UHD Jr units are used together for image mosaic, the total pixels of the LED screen are 7680×4320.



No.	Load Area Width	Load Area Height	Load Area Initial X	Load Area Initial Y
NovaPro UHD Jr 1	3840	2160	3840	0
NovaPro UHD Jr 2	3840	2160	0	0
NovaPro UHD Jr 3	3840	2160	0	2160
NovaPro UHD Jr 4	3840	2160	3840	2160

Working Mode

The NovaPro UHD Jr can work as a video controller (default) or fiber converter.

- Video Controller: Ethernet ports and optical fiber connectors are all used for output.
- Fiber Converter: Optical fiber connectors are used for input, while Ethernet ports are used for output.

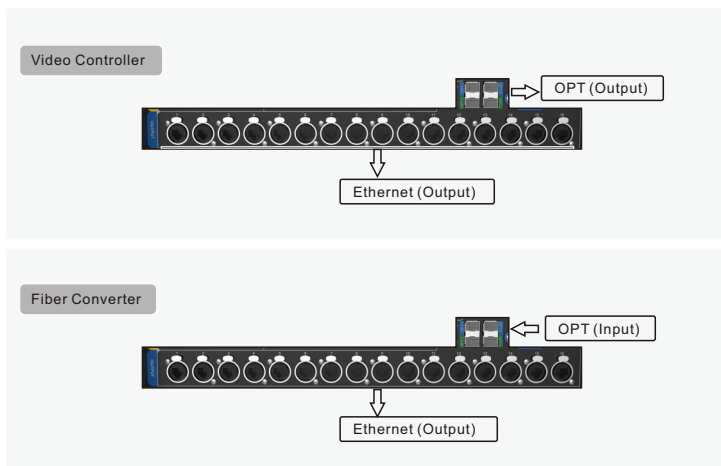

Advanced Functions

HDR

HDR function can realize smoother gradations, finer details and richer color density for the image, bringing you a more vivid and real visual experience.



Adjusting **Ambient Brightness**, **Peak Screen Brightness** and **Low Grayscale Mode** can achieve the best HDR effect.



Note

- Current HDR function of the device only supports HDR10 input source.
- When HDR function is enabled, the output loading capacity will be reduced by 50%.

Low Latency

When the NovaPro UHD Jr is used together with NovaStar Armor series receiving cards (A8/A8s/A9s/A10s Plus), this function can realize 2 frame delay from sending card to receiving card.

OPT Mode

The NovaPro UHD Jr supports 2 kinds of OPT modes: Hot Backup (default) and Copy.

- Hot Backup: OPT 3 serves as the hot backup for OPT 1. OPT 4 serves as the hot backup for OPT 2.
- Copy: OPT 3 serves as the copy for OPT 1. OPT 4 serves as the copy for OPT 2.

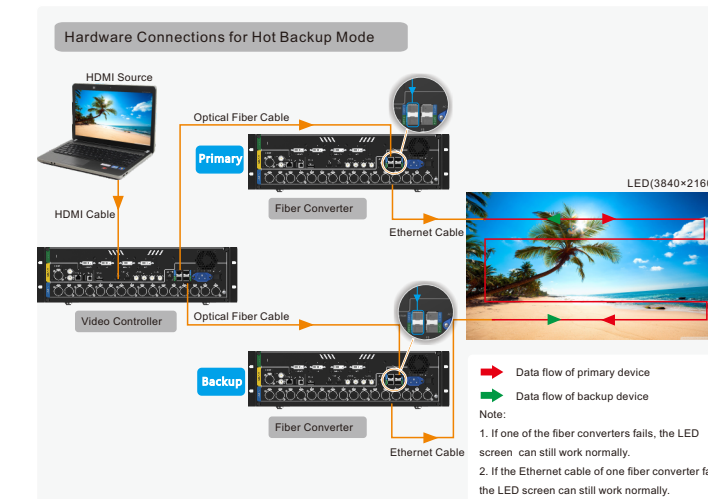
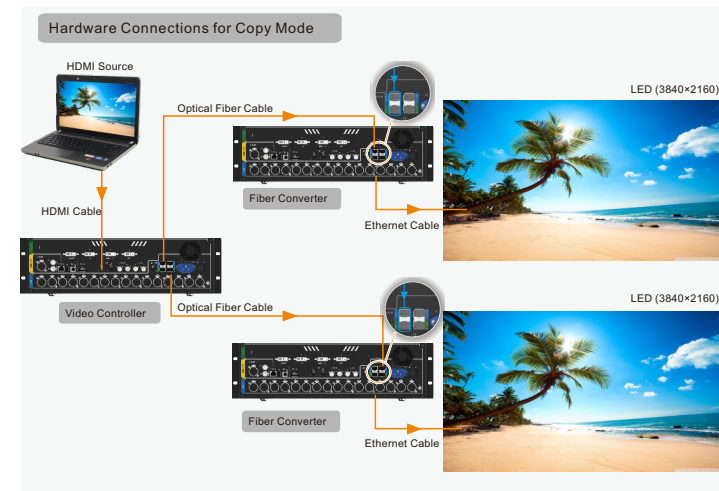

- Data flow of primary device
 - Data flow of backup device
- Note:
- If one of the fiber converters fails, the LED screen can still work normally.
 - If the Ethernet cable of one fiber converter fails, the LED screen can still work normally.

4

Specifications

Overall Specifications		
Connector	Qty	Description
Power connector	1	100V-240V~, 50/60Hz, 2A MAX
Operating temperature		0°C-50°C
Dimensions		482.6 mm × 396.5 mm × 139.0 mm
Overall power consumption		70 W
Net weight		6.3 kg

Toll-Free 24-Hour Hotline
400-696-0755

Xi'an NovaStar Tech Co., Ltd.
http://www.novastar.tech
101 Block D-F, 01 Square, Xi'an Software
Park, No.72, 2nd Keji Road, Xi'an, Shaanxi, China