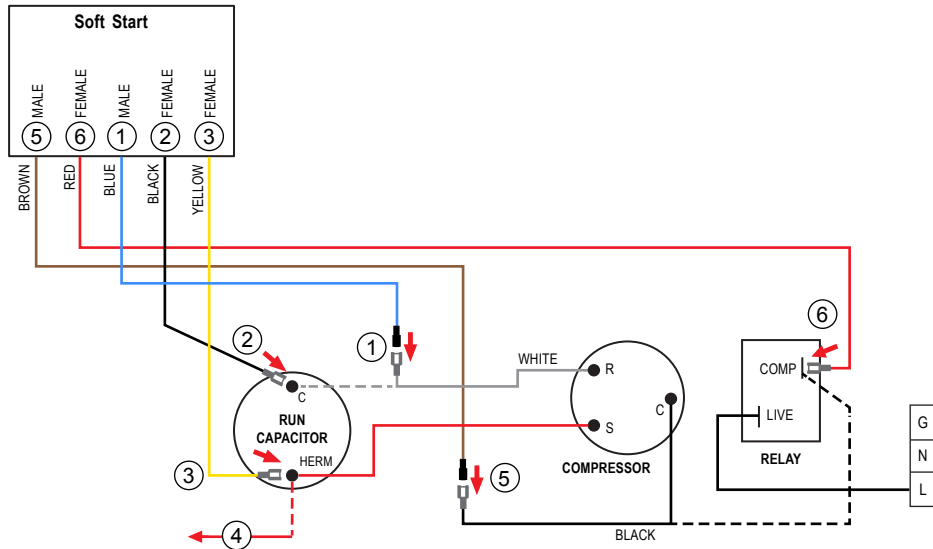

**WIRE CONNECTOR GUIDE****TURN ALL POWER OFF BEFORE STARTING INSTALLATION.**

Route all SoftStart wires into the electrical box. Crimp Connectors onto all SoftStart wires as indicated in drawing.

- Step ① Follow White Compressor wire to "C" terminal on Run Capacitor. Disconnect from terminal and connect it to Blue SoftStart wire. Seal connection with electrical tape.
- Step ② Connect Black SoftStart wire to the terminal that the White Compressor wire was on.
- Step ③ Connect Yellow SoftStart wire on terminal next to Red Compressor wire on HERM side of Run Capacitor.
- Step ④ **IF** there is a second Red wire next to Red Compressor wire on HERM side of Run Capacitor, disconnect it, seal end with tape and drop it.
- Step ⑤ Follow Black Compressor wire to the COMP Relay. Disconnect Black wire from Relay and connect to Brown SoftStart wire.
- Step ⑥ Connect Red SoftStart wire onto the terminal that the Black Compressor wire was on.

Secure all wires. Tape connections with electrical tape.

Turn Power and A/C Breaker on. Turn A/C to Auto Cool setting and the thermostat to 55°F.

Look at SoftStart LED lights. Green light should be "on". Green light means the Compressor is running (there may be a full 3-minute delay before Green light comes on). **IF there is no Green light after 4 minutes**, call SoftStart Tech Support for assistance.

Re-install all A/C covers. Turn A/C on, set near to outdoor temperature and run for 30 minutes.

After 30 minutes, operate A/C normally.

Wiring Diagram for Houghton-Belaire 2821 Relay