

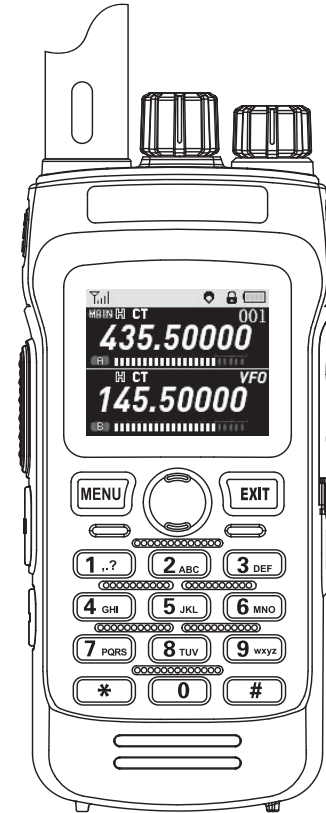

RECYCLED PACKAGING



THE INSTRUCTION MANUAL AND WARRANTY CERTIFICATE

Legal Notices

Under no circumstances shall the Company be liable for any loss of data or otherwise, or for any direct or indirect damage caused by any special event or accident.

The contents of this manual are provided as-is. Except as otherwise provided by applicable law, no warranties of any kind, express or implied are made, including but not limited to warranties of merchantability and fitness for a particular purpose. The Company reserves the right to revise or withdraw this manual at any time without prior notice.

If the contents of this manual do not match your walkie-talkie, please refer to the walkie-talkie.

The Company reserves the right of final interpretation of this manual.

Directory

1. Legal Notice.....	I
2. Table of Contents Index.....	II
3. Function Introduction.....	1
4. Random attachments.....	2
5. Loading and unloading accessories.....	2
6. Charging schematic.....	4
7. Charging precautions.....	5
8. Precautions for battery use.....	5
9. Power/volume switch.....	6
10. Familiarity with this machine.....	7
11. Icon Explanation.....	8
12. Keyboard Definition.....	9
13. Introduction to the operation of menu function.....	10
14. Special Function Description and Settings.....	13
15. Technical Parameters.....	16
16. Warranty Notice.....	18

Introduction to the feature

- Working frequency band
 - > FM 65 – 108 MHz (RECEIVE)
 - > VHF 108 - 134 MHz (AM reception)
 - > VHF 136 – 174 MHz (receive/transmit)
 - > UHF 220–260 MHz (receive/transmit)
 - > UHF 400 – 470 MHz (receive/transmit)
 - > BLE 2.4GHz ISM
- Digital tuning FM, AM radio
- Frequency sweeping, one-key frequency pairing function
- Voice encryption (frequency hopping function)
 - 5.8 zones with 64 storage channels each
- Support reverse frequency and off-grid function
- Dual-frequency point waiting
 - 8.50 groups of standard CTCSS (support non-standard subtones), 105 groups of DCS
 - 9.8 step frequencies (2.5, 5, 6.25, 10, 12.5, 20, 25, 50) KHz
- Power saving mode
- VOX voice-activated emission
- The channel is busy and forbidden
- Automatic backlight
- Three channel display methods (frequency, channel number, channel name)
- Emergency alarm
- Strong light flashlight function
- DTMF codec function
- Support GPS positioning information
- Support wireless Bluetooth write frequency function (optional)
- Identity code display

Before using the walkie-talkie, it is recommended that you:

Please open the box carefully to confirm that it contains the items listed in the table below. If you find this product and accessories If there is any loss or damage during the handling, please contact the dealer immediately.

Random attachments:

Items	Quantity
Walkie - talkie	1
Dual-segment antenna	1
Battery	1
Charging cradle	1
adapter	1
Back clip	1
Instruction manual	1

The accessories for Installing/removing

Install/remove the battery

The average battery life of the included battery is 96 hours.

The average usage time is measured at 5% transmit time, 5% receive time and 90% standby time.

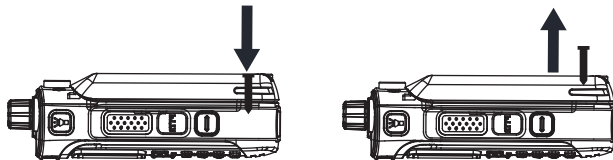

Install/remove the antenna

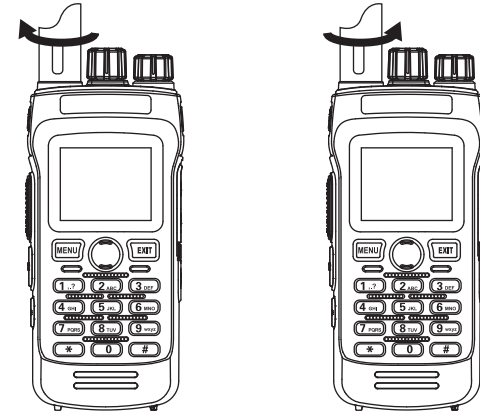

Install/remove the back clip

If necessary, align the back clip included in the package with the back clip screw buckle on the back of the walkie-talkie, and then lock it with a screw.

NOTE: If the belt clip is not installed, its mounting position will become hot in continuous communication or when left in a hot environment.

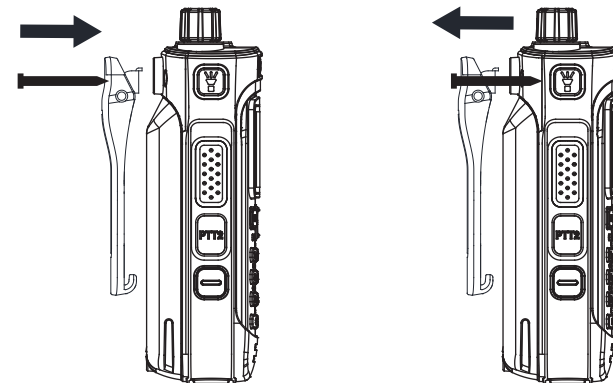

Install/remove the headset/microphone

>Remove the headset/microphone and place the headset/microphone

>The cover of the jack is back on the console

Note: When using external headphones/microphones, it will affect the waterproof performance of the walkie-talkie.



Charging

Note: When charging, please ensure that this product is turned off; Please use our designated charging cradle to charge the battery

1. Use the split charger to charge: put the battery or the whole machine with battery down the seat charging limit slot, and the indicator light is flashing red to indicate that the charging is normal. (Figure 1)

If the battery is not installed during the power-on process, the red light is solid, the red light flashes during charging, and the green light is solid when it is fully charged.(Figure 2)

2. Charging with TYPE-C:

Charging... The red light is on

Fill up.... The green light is on

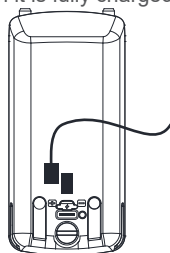

(INPUT VOLTAGE: DC5V/2A)

(Figure 2)



(INPUT VOLTAGE: DC9-12V)

(Figure 1)

Precautions for charger use

> To improve charging efficiency and ensure charging safety, please use 110-220V AC.

> short-circuit the charger is prohibited, otherwise it will cause electric shock, smoke and charger damage.

> Do not use the charger with the power cord damaged, otherwise it will cause fire and electric shock.

> Please clean up the dust accumulated on the power outlet in time.

> Please do not put the container containing water next to the charger to avoid water splashing out of the charger overheating, leakage and failure.

> Do not disassemble or modify the charger, as this may result in personal injury, electric shock, fire or damage to the charger.

> Please do not use the charger in a hot place such as a bathroom, otherwise it will cause electric shock, fire, or damage to the charger.

> Do not touch the charger, battery, power outlet with wet hands, otherwise it may cause electric shock.

Do not place heavy objects on the power cord > attempt to modify it, as this may cause electric shock or fire.

> unplug the power plug from the socket before cleaning and maintenance, grab the charger when pulling the plug, and hardpull the power cord, which may cause electric shock or fire.

Precautions for battery use

> Please do not short-circuit the battery, so as not to damage the battery, generate heat and cause fire.

It is >forbidden to leave the battery at high temperatures or throw it into a fire to avoid causing a fireworks explosion.

>If the battery is not used for a period of time, discharge it and store it in a dry, dark, cool place.

> Discontinue use when the battery and charging cradle are damaged or visibly aged.

> return discarded batteries to suppliers or place them at designated recycling points instead of household waste.

If the battery is broken, avoid contact with the substances inside, if it is contaminated to the skin, please rinse with plenty of water.

Seek help from a doctor if necessary.

Power/volume switch

Turn on the power of the walkie-talkie when turning clockwise; Turn counter-clockwise to the end, and turn off the power of the walkie-talkie when you hear a "click"; Turn clockwise to increase the volume, and vice versa.

After booting, the LCD display is as follows:

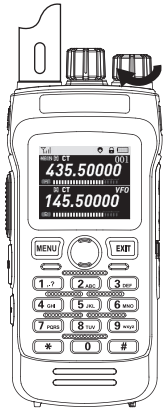

Power on/increase the volume

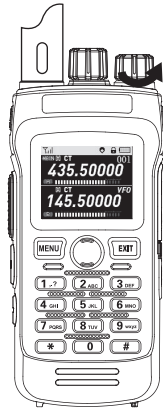





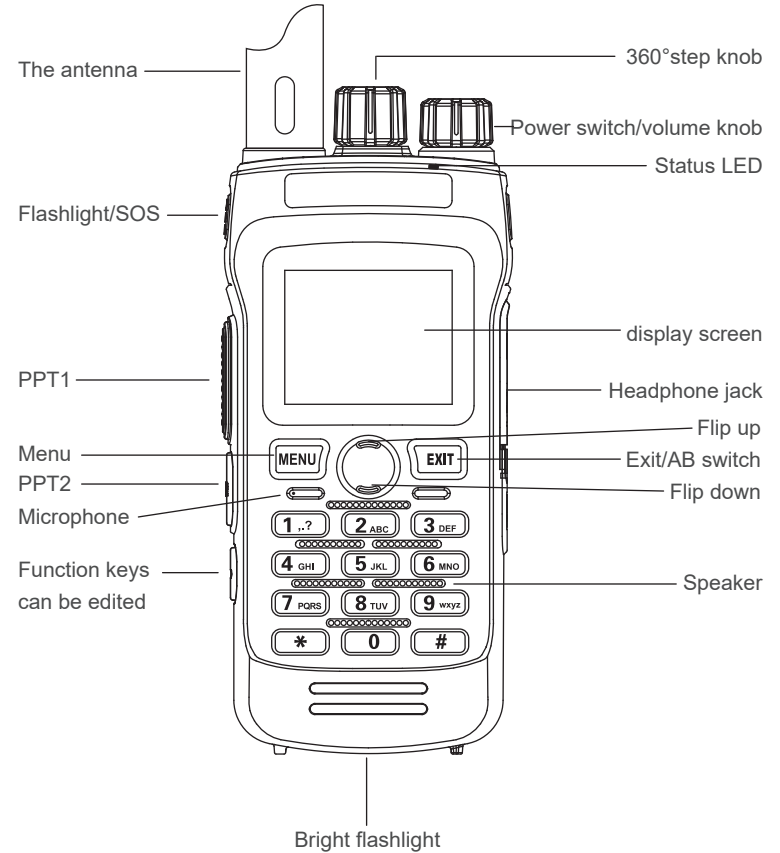



Volume down/shutdown

About this walkie-talkie



Icon explanation

Icon	Description
CT	• This symbol indicates that the current subtone is analogue CTCSS, and appears when transmitted, indicating that analog subtone signaling is being activated
DT	• This symbol indicates that the current subtone is a digital DCS, indicating that a digital subtone message is being activated
+	• This symbol appears in frequency mode, indicating that the transmit frequency is the received frequency plus a frequency offset
-	• This symbol appears in frequency mode, indicating that the transmit frequency is the received frequency minus a frequency offset
	• The dual-band standby function is turned on, two frequency bands displayed on the screen at the same time
	• Indicates that the voice-activated emission function (VOX) is activated, and the emission is started when the sound pressure level of the microphone reaches the set value
R	• Receive and transmit frequency reverse in frequency mode/channel mode
T	• Talk around mode and transmission frequency are adjusted to the same as receive frequency
N	• This symbol appears when the channel is operating in narrowband mode
	• Display current battery level: 4 level (high battery level); 3 level (middle battery level); 2-1 level (low battery level); 0 bar (low battery) The outer frame of the symbol flashes, and the walkie-talkie is prohibited from transmitting.
	• The symbol appears when the keyboard is locked, and press and hold the #/LOCK key to unlock it
H	• The current transmit power is high power
M	• The current transmit power is medium power
L	• The current transmit power is low power
	• The sidetone is on, which indicates that the unit emits a tone when the DTMF is transmitted
AM	• Display this flag, indicating that the current frequency is · AM modem mode
CR	• Indicates that the scrambling function is turned on
	• Indicates that Bluetooth is on
	• Indicates that GPS is on
	• Receive RSSI signal indication
	• Display the current transmit power intensity: (H) full, (M) 1/2 , (L) 1/3
SC	• Indicates that subtone encryption is on

Definition for Keyboard

Function keyboard

[MENU]: Menu selection/confirmation key.

Used to activate the menu mode, after entering the menu, use this to select items in the menu.

Move up key (long press for more than 2 seconds to move forward quickly; In the scanning state, change the scanning direction): [^]

Move down the key (long press for more than 2 seconds, quickly rewind; In the scanning state, change the scanning direction):[v]

[EXIT]: Exit key/Clear key

In the input state, clear the information that has been entered; In standby, press this button to switch the A/B interface; Long press to enter the GPS interface.

Numeric keypad

Used to enter information into the programming menu of the walkie-talkie; In the non-standard analog subtone editing state, non-standard subtone can be directly entered;

[*SCAN]: Press for a short time to switch reverse frequency, Talk around, normal mode; Press and hold for more than 2 seconds to start frequency or channel scanning; In the FM radio state, press this button to automatically search for FM stations; In the receiving subtone setting state,

Click here to start subtone scanning.

[#]: Press briefly to enter the DTMF code editing interface, and enter the DTMF code to be sent through the keyboard.

When it is less than 6 bits, you need to have the # key to end, press PTT after entering to send the code, press [EXIT] in edit mode to delete the code, press [EXIT]: to exit DTMF editing mode when clearing the code, press and hold for more than 2 seconds, the keyboard lock or revoke the keyboard lock.

[SOS]: Long press to enter alarm mode, and short press to exit alarm mode in alarm mode.

Introduction to menu function operation

When powered on, press the [MENU] key to enter the following ten main menu settings, press the flip key or step potentiometer to select the desired main menu, click the [MENU] key to confirm entering the submenu, select the desired function by flipping the up / down key or step potentiometer, and click the [MENU] key again to complete the setting. If you need to exit or return to the short press [EXIT] key.

I.[Region] Settings:

Quick operation [MENU] + "1" key, area 1... Zone 8 is optional

II. Intercom Settings:

1. Squelch level: 0... Level 9
2. Transmission power: high, medium and low
3. Channel bandwidth: wideband, narrowband
4. Scrambler function: off, Scrambling 1... Scrambling 8
5. Vox function: off, level 1... Level 9
6. Vox delay: 0.5 seconds, 0.6 seconds... 2.0 seconds
7. Dual-frequency Standby: ON/OFF
8. Power saving mode: off, ordinary power saving, super power saving, deep power saving
9. Busy channel lockout: on/off
10. TOT: off, 30 seconds, 60 seconds... 210 seconds, 240 seconds
11. Tail Noise Cancellation: On/Off
12. TONE sound: 1000HZ, 1450HZ, 1750HZ, 2100HZ
13. Scan mode: time, carrier, search
14. Call end tone: Turn off /BEEP/TONE1200
15. Tail tone cancellation on repeater: off, 100ms, 200ms、 ... 1000ms
16. Repeater tail tone detection: off, 100ms, 200ms、 ... 1000ms
17. SOS mode: on-site alarm, send alarm tone, send alarm code

III. 【Advanced Settings】 :

Quick operation [MENU] + "3" key

1. Sound: on/off
2. Voice Prompt switch: on/off
3. Automatic keypad lock: off, 5 seconds, 10 seconds, 15 seconds
4. Automatic backlight: On, 5 seconds, 10 seconds, 15 seconds, 20 seconds
5. Menu exit time: 5 seconds, 10 seconds、 ... 60 seconds
6. GPS positioning: on/off
7. Language selection: English/Chinese

【Frequency mode】 Settings:

Quick action [MENU] + "4" key

1. Step frequency: (2.5K, 5.0K, 6.25K, 10K, 12.5K, 20.0K, 25.0K, 50K) Hz
2. Frequency offset direction: none, forward, reverse
3. Frequency offset: can be input to set 0... 99.9999MHz

【Channel Settings】

Quick operation [MENU] + "5" key

1. Channel storage: select 001... Channel 064 (CH-0XX means that this channel has stored)
2. Channel delete; Select CH-001... CH-64 channel
3. Segment A display mode: channel name, channel + frequency, channel number
4. Segment B display mode: channel name, channel + frequency, channel number

[Subtone Settings]:

Quick action [MENU] + "6" key

1. Receive CTCSS: 51 groups of standard tone, off (enter "0" key to jump quickly)
2. Receive DCS; Normal or Invert DCS, off (enter "0" key to jump quickly)
3. Transmit CTCSS: 51 groups of standard tone, off (enter "0" key to jump quickly)

4. Transmit DCS; Normal or Invert DCS, off (enter "0" key to jump quickly)
5. Frequency hopping: Off
6. Encryption: On/Off
7. Subtone Scanning: CTCSS, DCS
8. Scanned subtone store: all, decode, encode

【Signaling Settings】 :

Quick operation [MENU] + "7" key

1. Identity code: CODE1... CODE15
2. DTMF code; Close, EOT, BOT, both (press/release)
3. Y signaling switch: on/off
4. Y signaling code: can freely edit any letter or number of 8 digits

【Side button define】 Settings:

Quick action [MENU] + "8" key

1. Short press the side button 2: radio, monitor, scan, search
2. Long press the side button 2: radio, monitor, scan, search

【This machine information】 :

Displays the current software version, hardware version, identity code, and other information

Quick operation [MENU] + "9" key

【Factory reset】 Settings:

Quick operation [MENU] + "1" and "0" keys

1. Frequency mode:
2. All:

Special feature descriptions and settings

1. One-key frequency pairing

First, through the main menu [Side Key Define] set long press or short press, set the button to SEARCH, at this time enter the frequency search mode, through [MENU] key to select frequency bands to search (UHF/VH-F/200M/300M), after capture frequency and subtone, press the [MENU] key to save the frequency and tone. Channel pairing is complete.

2. Dual PTT function

In dual PTT mode, press PTT to transmit segment A and PTT2 to transmit segment B.

3.AM aviation band

When the operating frequency range is between 108M and 136M, the machine automatically enters AM receiving mode and the channel status is displayedAM, this mode is mainly used to receive AM modulation signals.

4. Scanning method

Before using scanning, you must decide under what conditions you want the walkie-talkie to follow after detecting a signal

Continue scanning.

You can choose one of the following modes:

(1) Time operation mode (TO)

The walkie-talkie stops scanning when it detects a signal, and after about 5 seconds, even if the signal is still there,

The walkie-talkie will also continue scanning.

(2) Carrier operation mode (CO)

The walkie-talkie stops scanning and stays at the same frequency when it detects a signal; Until the signal disappears. In the signal

A 2-second delay between disappearing and scanning recovery gives the response time to start transmitting.

(3) Search operation mode (SE)

The walkie-talkie exits the scan and stays at this frequency when it detects a signal.

5. Radio function

- (1) Press the FM function key, the radio function will be turned on, and the screen will display the current frequency of the radio.
- (2) You can press the [Up/Down] key to adjust the frequency of the radio; You can also press the keypad directly for numeric input (frequency range (65.000~108.000MHz); At the same time, press the * key in the radio state to enter the automatic search mode.
- (3) Volume adjustment can be adjusted by power/volume switch.
- (4) If you want to turn off the radio function, press the FM function button again to turn off this function.

Note: The FM function keys need to be matched in the side button custom function

6. NOAA function

Press and hold the [0] button to enter the NOAA band

7.DTMF

- (1) DTMF code

Quick code: press the number keys, *, #, MENU, UP, DOWM, V/M, A/B in the transmitting state,

Transmit DTMF codes 0-9, ABCD*#. Press the button to continue sending the code, and release the end code.

Send code after editing: Press the # key in standby mode to enter the DTMF editing interface, and press the keyboard at this time to enter DTMF

The encoding is 0-9, ABCD*#, when it is less than 6 bits, it needs to end with the # key, and press PTT after entering to send the number code, press [EXIT] to delete the code in edit mode, and press [EXIT] to exit DTMF edit mode when clearing the code.

- (2) DTMF decoding

8. GPS positioning function (optional function)

Press and hold the [EXIT] button to enter the GPS positioning interface, and press the [MENU] key to switch the coordinate display mode and image mode.

9. Bluetooth Programming function

Support walkie-talkie frequency and parameter configuration by Bluetooth (optional function)

10. Key combination operation function

1. Audio call:

Press the PTT key and then press the [SOS] key for audio call (1750Hz) function: The unit emits 1750Hz

Audio, release the monitor key to exit.

2. DTMF real-time coding:

Press the transmit key to transmit press the number key, *, #, MENU, UP, DOWM, V/M, A/B, and launch DTMF number

Yards 0-9, ABCD*#.

Specifications

General parameters	
Frequency range	(136-174/220-260/400-520)MHz
Number of channels	512 (64*8)
Frequency bandwidth	25 KHz/12.5 KHz
Operating temperature	-20°C ~ +60°C
Antenna impedance	50Ω
Operating voltage	DC 7.4V (±20%)
Battery capacity	3000mAh
Frequency stability	≤±2.5ppm
Form factor	58(L)*42 (W)*141 (H) mm
weight	305g
Operating temperature	- 20°C - +75°C:
Storage temperature	- 40°C - +85°C
Charging method	DC9-12V/ type-c(5V)
Screen size	1.77寸
Launch section	
RF output power	High: 10W Medium: 5W Low: 1W
Modulation mode	16KΦF3E(wide)/8K50F3E(narrow)
Clutter and harmonics	≤-36dBm
Frequency modulation noise	≤-40dB
Audio distortion	≤5%

Adjacent channel power	≥65 db(wide) /60 dB(narrow)
Modulation limits	<5KHz(wide) /2.5KHz (narrow)
Receive section	
sensitivity	≤0.2μV(wide) /0.25μV (narrow)
Adjacent channel selectivity	≥60dB(wide) /55dB(narrow)
Intermodulation immunity	≥60dB(wide) /55dB(narrow)
Stray immunity	≥60dB(wide) /55dB(narrow)
Signal-to-noise ratio	≥45dB(wide) /40dB(narrow)
Audio output power	1.0W
Audio distortion	≤5%

Product warranty

Distributors	Distributor (stamped valid)
	Address:
	Contact Number:
Product information	Product model
	Serial number:
	Date of purchase:
User Information	User Name:
	Address:
	Contact Number:

Important: This warranty card is an important proof for the end user to enjoy the warranty service, please keep it properly.

Warranty Notice:

1. The warranty period of this product is calculated from the date of sale (subject to the date on the sales invoice), the warranty of the host is 12 months, and the warranty of the accessory is 6 months.
2. During the warranty period, the logo or serial number of the product shall not be torn.
3. This warranty card must be stamped and completed by an authorized dealer to be valid.

Under the following circumstances, the product will not enjoy the free warranty service,

Under the following circumstances, the product will not enjoy the free warranty service, need to pay for repair:

1. Normal wear;
2. Exceeding the product warranty period;
3. Damage caused by failure to use, maintain and store in accordance with the requirements of the product instructions;
4. Damage caused by unauthorized repair, disassembly, etc.;
5. There is no valid warranty card and valid invoice (except for those who can prove that the product is within the warranty period);
6. Altering the product warranty card without authorization;
7. The product model or serial number on the warranty card does not match the actual product;
8. Damage caused by force majeure.