

4D-F10

Suitable for ages over 14

Quadcopter operating instructions

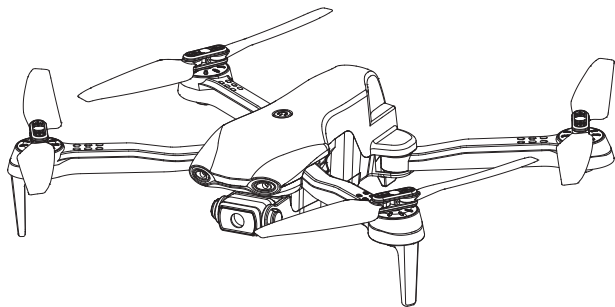

WIFI version

English

- In order to meet the requirements of the aeronautical radio station's electromagnetic environment (various of aero models and UAV are not allowed to fly within the range of 10 km on each side of center line and 20km on both ends of the airport runway and in the) and civil aviation routes and airlines. Using various models and drones in the no-fly zone issued by the relevant state departments is prohibited.

Warning

1. The packaging and instructions contain important information and should be kept.
2. With this aircraft, you are responsible for ensuring that no harm will be caused to the personal and property of others.
3. Commissioning and installing of aircraft must be strictly in accordance with the operating instructions, and attention shall be paid to the distance between the aircraft and the user or other people shall be 2 to 3m to prevent the aircraft from bumping into the head, face and body of people and causing injury in flying and landing, etc.
4. Our company and distributors are not responsible for any loss and damage, as well as injury to people caused by improper use or operation.
5. Children should be guided by adults when operating the aircraft. This product is prohibited to be operated by children under 14 years old.
6. Please follow the instructions or packaging instructions to install and use correctly, and some parts should be assembled by adults.
7. The product contains small parts, please place it out of the reach of children to prevent the risk of accidental eating or suffocation.
8. It is strictly forbidden to play on the road or in the place where water is accumulated to avoid accidents.
9. Please put away the packing materials in time to avoid harm to children.
10. Do not disassemble or modify the aircraft. Disassembly or modification may cause malfunction to the aircraft.
11. The charging cable needs to be inserted into the designated power supply 5V $\overline{\text{---}}$ 2A that is the same as the product label.
12. The use of other charging cables will cause damage to the battery and may cause unexpected dangers.
13. The charging cable is not a toy.
14. When charging the rechargeable battery, it must be under the supervision of an adult. When charging, it must be far away from flammable materials. During charging, the guardian should not leave the monitoring range.
15. Please do not short circuit or squeeze the battery to avoid explosion.
16. Do not mix different types of lithium batteries.
17. The aircraft uses a rechargeable lithium battery, which needs to be pulled out for charging.
18. Do not short-circuit, decompose or throw the battery into fire; do not put the battery in a place with high temperature and heat (such as in fire or near electric heating device).
19. The aircraft should be used as far away from other electrical equipment and magnetic objects as possible, they may cause mutual interference.
20. Please keep a safe distance from the high-speed rotating propeller to avoid the risk of scalp or cut
21. The motor is a hot part; please do not touch it to avoid burns.
22. LED has laser radiation; please do not give direct light beam to others.
23. Do not use the model near your ears! Misuse may cause hearing damage.
24. The USB charging cable must use the data cable provided by our company to charge the battery, otherwise it will cause serious damage to the battery and will lead to unexpected danger.
25. To meet the magnetic environment requirements of aeronautical radio stations. During the radio control order issued by the relevant state departments, the model remote control should be stopped within the city area as required.
26. Turn off the switch and unplug the battery when the battery of the aircraft is used up, and charge after 30 minutes of rest, otherwise the battery will be easily damaged.

1. List of accessories included:



Aircraft×1



USB charging cable×1



Fan blade×4

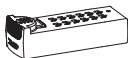

Lithium battery×1



Screwdriver×1



Operating Instructions×1

2. Name of each part of aircraft:

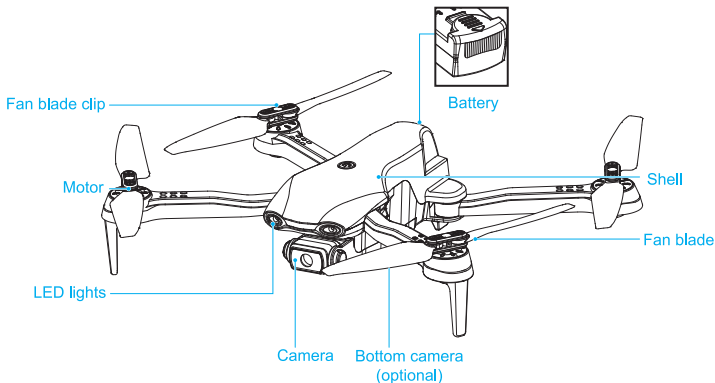

3. Wind blade installation diagram:

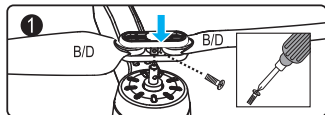

3.1 Unscrew the screw and remove the fan blade.

! Note: The fan blade is printed with letters of ABCD, in which, A = C, B = D, please install it correctly according to the diagram, otherwise it cannot take off

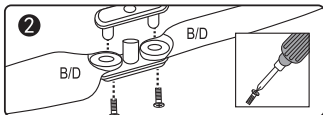

3.2 Loosen the screw, open the two fan blades and the connecting parts, and remove the fan blades for replacement. (when B/D fan blade is broken, replace B/D, and so do to A/C fan blade, error in replacement will cause that it can't take off)

4. Unfolding steps of the aircraft: (It is in the storage state when it leaves the factory)

1. Unfold the aircraft according to the steps

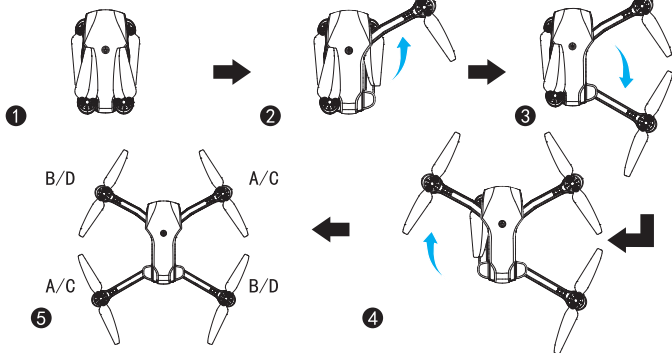

5. Lithium battery charging instructions:

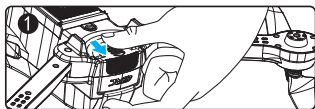

5.1 Buckle the battery lock of the aircraft.

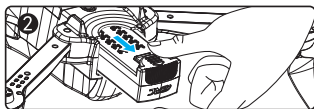

5.2 Remove the battery.

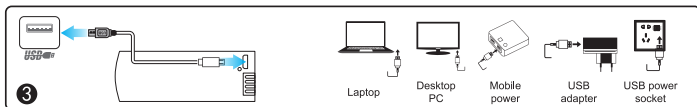

5.3 Charging: Insert the USB port of the USB charging cable into the computer USB port (or use 5V \equiv 2A power adapter), and connect the other end of the USB charging cable to the battery socket. When charging, the blue indicator on the module battery is on, and when the battery is fully charged, the green indicator light is on, which means that the charging is complete.



It must be charged with the aircraft charging cable provided by the factory, and other charging cables cannot be used. Be sure to remember to avoid accidents.

Warning

When not flying, remove the battery from the bottom to avoid battery damage.

6. Name of each part of the remote control:

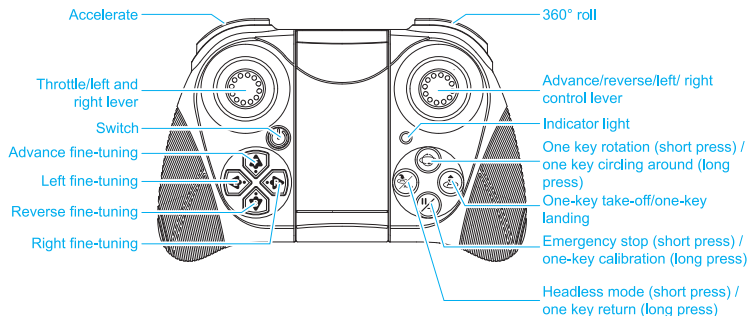

7. Remote control battery installation:

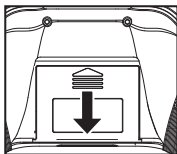
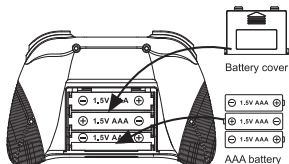

Battery installation:

- 7.1 Remove the battery cover.
- 7.2 According to the polarity instructions on the battery compartment, remove the battery cover on the back and insert a 3X "AAA" battery (not included).

Note

1. The positive and negative poles and the positive and negative poles of the battery box must be identified when inserting the battery, and error is not allowed.
2. Do not mix old and new batteries.
3. Do not mix different types of batteries.

Instructions in charging:

- Do not put the charged battery in a place with high temperature and heat, such as an open flame or an electric heating device, otherwise damage or explosion may occur.
- Do not hit or beat the surface of hard objects with the battery.
- Do not disassemble the battery.
- Do not immerse the battery in water, and please store the battery in a dry place.
- Do not leave battery alone when charging.

8. Environmental requirements before flight:

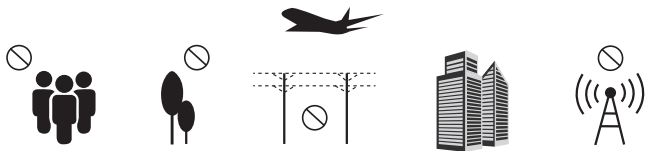

Please choose an outdoor and open environment with no rain and snow and low wind. Please stay away from crowds, trees, wires, tall buildings, airports, and signal transmission towers when flying. Do not fly in a too small indoor environment with lots of things.



APP can only be viewed (photographed/recorded) when using the remote controller, and the remote controller cannot be used when using APP.

9. Pre-flight preparation instructions (using remote control):

- 9.1 Aircraft frequency matching: Turn on the power of the aircraft and place it on a horizontal surface. At this time, the aircraft placed on the horizontal surface will automatically enter the frequency matching state, and the front white light and the rear red light will flash.

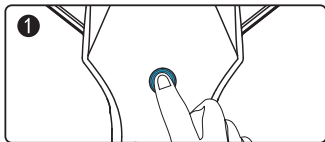

⚠ Note: Set the aircraft in a correct direction, and the nose shall face forward. It must be placed on the horizontal plane.

- 9.2 Press and hold the power switch button of the remote control ① (step 1), and the power indicator of the remote control will be on; push the throttle lever up to top (step 2) and then to the end (step 3), code-matching will succeed, and the aircraft light will change from flashing to be always on.

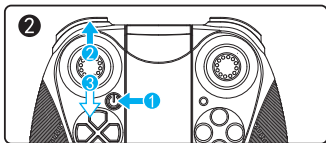

The aircraft/remote controller must ensure sufficient power or it cannot take off!

9.3 Horizontal calibration operation:

Press and hold the calibration button on the remote control , the LED light on the aircraft flashes quickly. The LED lights on the aircraft are always on, which means the calibration is complete, and the remote controller emits a "beep" (Figure 1).

 **Note:** The calibration must be completed only when the aircraft is placed on a horizontal plane.

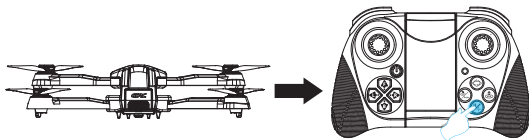





Figure 1

9.4 Start/stop

Push the left control lever on the remote control upward (Figure 2). At this time, the aircraft can take off normally. After taking off, all the indicator lights of the aircraft will always be on. During the flight, whether you short press the  key, the aircraft will stop flying (Figure 3).

 **Note:** This function operation is only suitable for the aircraft in an uncontrolled state. Under normal circumstances, it is recommended to use the one-key takeoff/one-key landing  key.

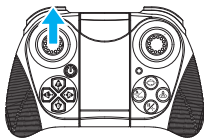

Figure 2

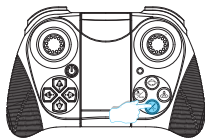



Figure 3

9.5 One-key take-off and landing

When the frequency matching is completed, lightly press the remote control "one-key takeoff/landing" button  (Figure 4), the aircraft will automatically rise to a height of about 1 meter, and keep flying at this height; when this function key is pressed again, the aircraft will automatically land on the ground slowly.

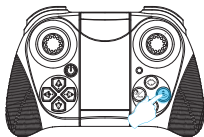
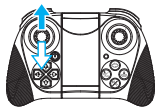

Figure 4



Operate the aircraft with the remote control. Before taking off, please operate according to the above sequence: Turn on (refer to 9.1)→ frequency matching of the remote control starts (refer to 9.2)→horizontal alignment (refer to 9.3)→start/stop (refer to 9.4)→ one-button taking off and landing (refer to 9.5)

10. Remote control method:



When the left joystick (throttle) is pushed up, the rotation rate of the main blade increases and the aircraft rises.

When the left joystick (throttle) is pushed down, the rotation rate of the main blade slows down and the aircraft descends.

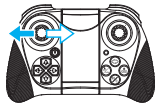

When the left joystick (rudder) is pushed to the left, the aircraft nose turns to the left. When the left joystick (rudder) is pushed to the right and the nose of the aircraft will turn to the right.

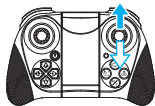

When the right joystick (rudder) is pushed up, the aircraft moves forward.

When the right joystick (rudder) is pushed down, the aircraft moves backward.

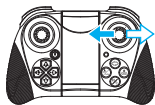

When the right joystick (rudder) is pushed to the right, the aircraft fuselage deviates to the right.

When the right joystick (rudder) is pushed to the left, the aircraft fuselage deviates to the left.

11. 360° roll:

The aircraft can achieve 360-degree flight by the following joystick operation. In order to better perform the roll function, a height of about 1.5 meters shall be ensured between the aircraft and the ground. It is best to operate the aircraft to roll during the ascent stage, so that the aircraft can maintain the height more easily after rolling.

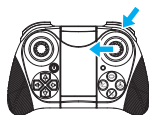

11.1 360° roll on the left

Short press the 360° roll button, then push the right joystick to the left, and the aircraft will flip 360° to the left accordingly.



11.2 360° roll on the right

Short press the 360° roll button, then push the right joystick to the right, and the aircraft will flip 360° to the right accordingly.



11.3 Roll Forward 360°

Short press the 360° tumble button, then push the right joystick upward, and the aircraft will turn forward 360° correspondingly.

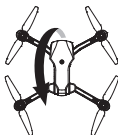



11.4 360° roll backward

Short press the 360° roll button, then push the right joystick down, and the aircraft will flip 360° backward accordingly.

12. Introduction of remote control function and operation:

12.1 Headless mode

The front of the aircraft when the code-matching is turned on is by default the front in headless mode; if it is necessary to adjust the direction, please turn on the code-matching again, and short press the remote controller "headless mode" function key  (Figure 5). When exiting, please tap gently press this function key again.

 **Special Tip:** Please make sure the aircraft is aligned with the straight line and let the gyroscope automatically detect the straight line, and the headless mode of straight line flight can be realized.

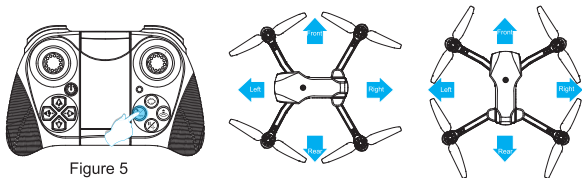



Figure 5

12.2 One key return

When the flying distance of the aircraft is too far, the aircraft can be recalled with the return function. When turning on the code-matching, the remote control must be directly facing the tail of the aircraft. During flight, press and hold the one-key home button  (Figure 6). When the remote control emits a "beep" sound, the aircraft will enter the one-key home function, and will automatically return to our side; when the joystick is operated in any form, the aircraft will be released from the home function.

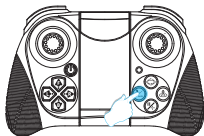

Figure 6

12.3 Speed switching

When the aircraft takes off, it is by default in the low-speed mode (3-gear switching); gently press the remote control by a "beep" sound for low-speed gear, two "beep" sounds for medium-speed gear, and three "beep" sounds for high-speed gear (Figure 7).

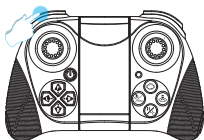
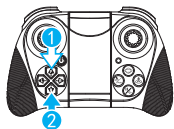
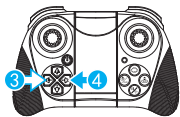

Figure 7

12.4 Fine tuning function



1. Fine tuning of aircraft moving forward/backward
When the aircraft leaves the ground and the aircraft deviates to the rear, press and hold ① forward fine-tuning key to fine-tune; when the aircraft deviates to the front, press and hold ② backward fine-tuning key to fine-tune.



2. Fine tuning of aircraft deviates to the left/right
When the aircraft leaves the ground and the aircraft deviates to the right, press and hold ③ left fly fine-tuning key to adjust, and when the aircraft deviates to the left, press and hold ④ right fly fine-tuning key to adjust.

13. APP download and installation instructions:

13.1 Download and install the software

For Google mobile phone, after scanning the code, choose to open and download in the browser



 Download on the
4D FLY APP

Google system: Please scan this QR code to install, then click on the upper right corner to open and download in the browser



 Download on the
App Store

IOS system: please scan this QR code to install

13.2 Link description

- ① Turn on the power of aircraft, enter the (Settings) option (of mobile phone or IPAD), and open the wireless network; find the device name of "4DRCC*****" in the wireless network search list and connect; after connection, exit the setting option.
- ② Open the software icon "of 4D FLY" in mobile phone to enter the control interface. (Try to stay away from other signal source environments when flying)

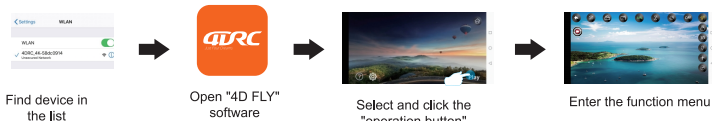

14. APP control interface function introduction:

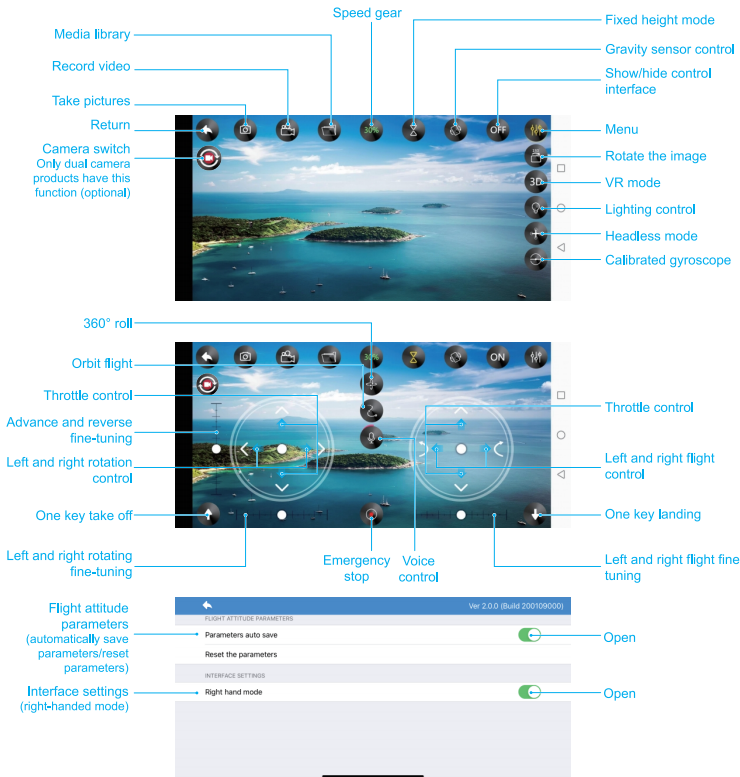

APP setting: When the control switch is turned on, click the APP main page setting button to adjust the parameters.

⚠ Special prompt: The interface setting (right-handed mode) will turn the control interface operation lever horizontally, which is convenient for the crowd who operate with left or right hand.

15. Pre-flight preparation instructions (using APP):

15.1 Aircraft frequency matching: Turn on the power of the aircraft and place it on a horizontal surface. At this time, the aircraft placed on the horizontal surface will automatically enter the frequency matching state, and the front white light and the rear red light will flash.

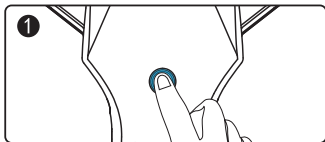

 **Note:** Set the aircraft in a correct direction, and the nose shall face forward. It must be placed on the horizontal plane.

15.2 Turn on the WiFi function in the mobile device, select "4DRC*****" (Figure 8) in the WiFi list, and turn on APP after it is connected successful. Click OFF (Figure 9), turn on the touch rocker, click,  and the aircraft lights will turn on normally, indicating successful frequency matching (Figure 10).

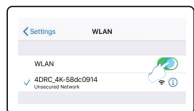

Figure 8



Figure 9



Figure 10

15.3 Horizontal calibration operation:

APP Application operation: click the "correction" icon in the app interface. The LED lights on the aircraft flash and the calibration of the LED lights on the aircraft is completed (Figure 11).

 **Note:** The calibration must be completed only when the aircraft is placed on a horizontal plane.



Figure 11

15.4 One-key take-off and landing

APP operation: Click the "one-key take-off" ❶ icon (Figure 12) in the APP control interface, and the one-key take-off function can also be realized; during the flight, press "one-key landing" ❷, the aircraft will automatically land slowly.



Figure 12



APP operation: Before taking off of the aircraft, please follow the steps in the above sequence: turn on (refer to 15.1) → APP start the frequency matching (refer to 15.2) → level calibration (refer to 15.3) → one key take-off and landing (refer to 15.4)

16. APP Application Control Method:



When the left joystick (throttle) is pushed up, the rotation rate of the main blade increases and the aircraft rises.

When the left joystick (throttle) is pushed down, the rotation rate of the main blade slows down and the aircraft descends.



When the left joystick (rudder) is pushed to the left, the aircraft nose turns to the left. When the left joystick (rudder) is pushed to the right and the nose of the aircraft will turn to the right.



When the right joystick (rudder) is pushed up, the aircraft moves forward.

When the right joystick (rudder) is pushed down, the aircraft moves backward.



When the right joystick (rudder) is pushed to the right, the aircraft fuselage deviates to the right.

When the right joystick (rudder) is pushed to the left, the aircraft fuselage deviates to the left.

17. APP Application function operation introduction:

17.1 Headless mode

APP Application operation: the front of the aircraft when starting up for frequency matching is the front of headless mode by default; Whether you need to adjust the direction you need, please restart the frequency matching, enter the APP Application interface, expand the function menu and click the headless mode function (Figure 13). when exiting, please click this function icon again.

Special Tip: Please make sure the aircraft is aligned with the straight line and let the gyroscope automatically detect the straight line, and the headless mode of straight line flight can be realized.



Figure 13

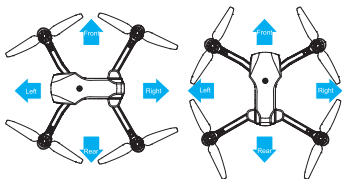

17.2 Speed switching

APP Application operation: click the "30%" icon in the app control interface (Figure 14) to switch the flight speed of the aircraft.



Figure 14

17.3 Orbit flight

APP Application operation: when the control switch is on, click the track flight button to open the drawing board. Use your fingers to draw a flight path on the drawing board, and the aircraft will follow the path drawn by your fingers (Figure 15).



Figure 15

17.4 Gesture Recognition

When the preview screen is displayed, click the gesture control button to turn on the gesture control function.

 **Special Tip:** Please face the lens with the front being at a position about 2-3M away and in a better light and background environment to perform the gesture recognition.



OK (right hand) gesture photographing

Stand at 3m in front of the lens of the aircraft, raise right hand and make OK gesture. After the aircraft recognizes the gesture, it will take photo after counting down 3 seconds.



V gesture recording

Stand at 3m in front of the lens of the aircraft, raise one hand and make V gesture. After the aircraft recognizes the gesture, it will record. When it recognizes another gesture, the recording will stop (the time interval shall be longer than 3 seconds)

17.5 Fine tuning function



1. Fine tuning of aircraft moving forward/backward
When the aircraft gets off the ground and deviates backward, press ① "forward fine tuning" button to adjust. If the aircraft deviates forward, press and hold ② "backward fine tuning" button to adjust.



2. Fine tuning of aircraft deviates to the left/right
When the aircraft gets off the ground and deviates right, press ③ "left fine tuning" button to adjust. If the aircraft deviates left, press and hold ④ "right fine tuning" button to adjust.

18. FAQ and solving guidelines:

Question	Reason	Solution
The aircraft indicator flashes without any response	The aircraft has insufficient power	Charge the battery
The blades of the aircraft rotate but cannot fly	1. Low battery 2.1 Blade deformation 2.2 Installation error of AB propeller	1. Charge the battery 2.1 Replace the blade 2.2 The fan blades are printed with letters A and B. For fan blade A or B, replace the one that is broken.
The aircraft vibrates badly	Blade deformation	Replace the blade
Fine tuning is done but still can't make the aircraft stable	1. Blade deformation 2. Defective motor	1. Replace the blade 2. Replace the motor
After the impact, start the aircraft again and it fly uncontrollably	The three-axis acceleration sensor loses its balance due to impact	After leaving the aircraft for 5-10 seconds, or by the horizontal calibration, it will be ok. For the steps, please refer to the manual, 9.3 horizontal calibration operation.