

BODEGA

User Manual CAR FRIDGE

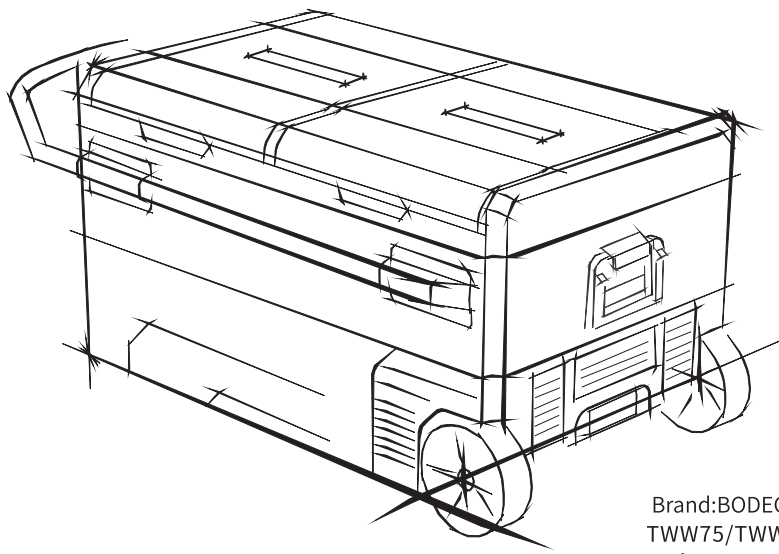

Brand: BODEGA
TWW75/TWW95
DC 12V/24V AC100-240V

PLEASE READ INSTRUCTIONS CAREFULLY BEFORE ASSEMBLY
RETAIN THIS MANUAL FOR FUTURE REFERENCE

Quick Guidelines



This icon marks references to other pages in this manual.

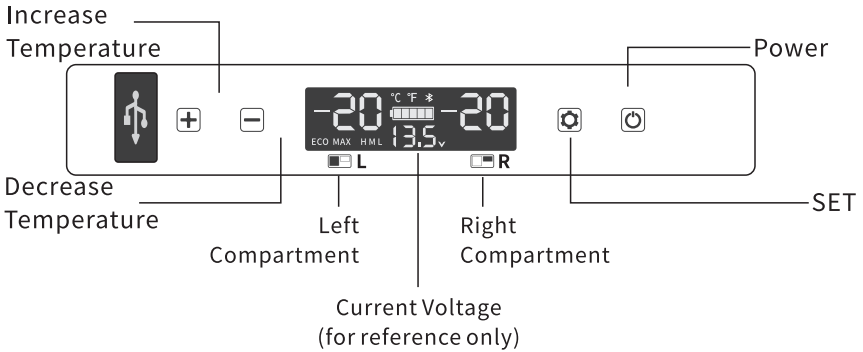

First Step: connect with 12/24V DC or 100~240V AC (with adapter) power.

Second Step: press “” to switch ON, long press “” for 3 seconds to switch OFF.

Third Step: press “+” or “-” to adjust temperature. (6)

Cooling Mode: press “” to switch cooling mode between MAX (fast cooling) and ECO (Economical).

ECO

(Economical mode)

MAX

(Fast cooling mode)

Battery Protection Mode: hold “” over 3 seconds until screen flashes, then press “” again to select battery protection mode.(6)

H

(High)

M

(Medium)

L

(Low)

Temperature Unit Setting: default setting is centigrade °C. If you want to change to Fahrenheit°F, please refer to 6.

°C

(Centigrade)

°F

(Fahrenheit)

Manufacturer:Foshan Alpicool Electric Appliance Co., LTD.

Address:13A Xinlong Road Shiongliyue industrial Zone, Xintang Village, Lunjiao Town,Shunde District, Foshan City, Guangdong, China

Contact:Tracy Tel:+8618680277793 E-Mail:logistic01@iaobosi.com

Contents

1、Safety Instructions	-----	Page1
2、Product Features	-----	Page2
3、Product Structure	-----	Page2
4、Function and Setting	-----	Page3
5、APP Connection	-----	Page4
6、Cleaning and Storage	-----	Page6
7、Troubleshooting	-----	Page7
8、Technical Data	-----	Page8
9、Warranty	-----	Page9

1.Safety Instructions

To prevent damage to your product or injury to yourself or to others, read the following safety precautions in their entirety before using this equipment. Keep these safety instructions where all those who use the product will read them.



This icon marks warnings. Failure to obey these warnings could result in malfunction of your fridge and possible injury for yourself and other users.

- Do not expose your fridge to heat and direct sunlight.
- Do not place in humid places to avoid leakage or electric shock.
- Do not put any electrical devices inside the fridge as they could damage the fridge.
- Do not soak the fridge into water or expose it to rain.
- Do not upside down for drainage
- Do not block the gaps of the fridge with things like pin, wire, etc.
- Do not allow children to play on or in fridge.
- Do not use the fridge if abnormalities are noticed such as smoke, overheating, leakage etc.
- Do not let other technicians to repaired the malfunctional fridge, except the staff from our company.



Notices

- Use wet cloth to clean your fridge before use.
- Make sure the voltage is within the proper range for the socket and cable being used.
- The fridge should be unpacked and stand still for more than 6 hours before switching on the power

- Make sure the refrigerator stays horizontally when it is working. The tilt angle should be less than 5° in long run and be less than 45° in short run.
- The fridge needs some space for good ventilation to work properly, at least 200mm at the back and 100mm at side.
- The installation of the DC power source in a boat should be handled by qualified technician.
- Please contact us for maintenance if your fridge gets malfunctional.

2.Product Features

- High efficiency DC compressor and module which is robust and durable.
- Fast cooling to -20°C/-4° F (based on 25°C/77° F room temperature).
- 3-stage low voltage battery protection.
- CFC free and low energy consumption.
- DC12V/24V or AC 100~240V (with adapter) power supply.
- Robust wheels and stretchable handle
- Invertible door for installation
- Dual-zone for cooling and freezing.
- LED display for temperature setting.
- APP control via Bluetooth



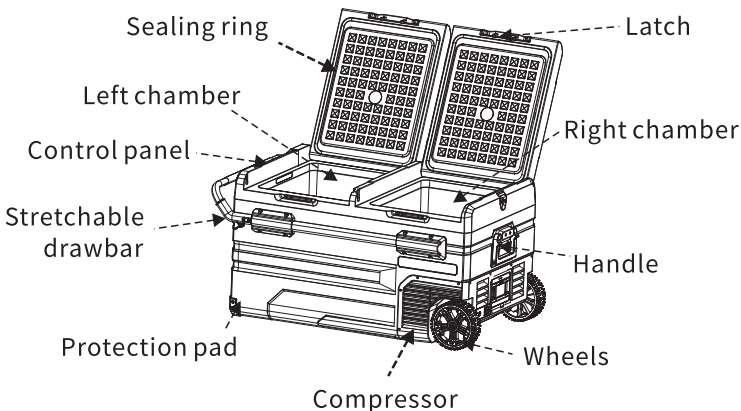



3.Product Structure

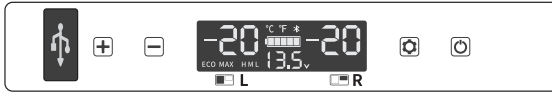





4. Function and Setting











• **Display Screen Initialization:** Connecting with electricity, the buzzer rings and the display screen lights up for 2 seconds, being into normal operation mode.



- **Power Supply:** Can be connected with DC 12/24V or AC 100~240V (with adapter).
- **Power On/Off:** press  to switch ON, long press  for three seconds to switch OFF.
- **Temperature Setting:** under the running state, long press  and  at the same time for three seconds to switch ON/OFF the left compartment, long press  and  at the same time for three seconds to switch ON/OFF the right compartment, two compartments cannot be switched off at the same time.

When both left and right compartments are set in running state, press  or  to enter left compartment temperature setting, press  to increase temperature, press  to decrease temperature, and press  to switch left/right compartment. The setting will be saved after stop operating for four seconds (Note: the temperature displayed is the current temperature of the compartments, it'll take a while to reach the set temperature.)

Temperature setting range: -20~20°C (-4~68°F)

- **Cooling Mode Control:** Press the button  to select cooling mode. You can switch mode between MAX (Quick cooling mode) and ECO (Economical mode).
- **Battery Protection Mode:** Hold the button  over 3 seconds, the screen will flash, then you can select L (Low), M (Medium), H (High) mode for your battery protection. The default setting is H mode. When the fridge is powered by car battery, it is recommended to set H mode. When the fridge is powered by built-in battery or portable battery, it is advised to set M or L protection mode. The reason is that various cars have different output voltage. If battery protection occurs (screen displays F1), the protection mode should be adjusted from H to M or L. When the engine is switched off, the fridge is still able to work. Protection mode should be set to H to prevent car battery from exhaustion.
- **Temperature Unit Setting:** press  to switch off the fridge, then press  over 3 seconds until E1 shows on the screen. Press  from E1, E2.....switching to E5. When the screen flashes, press  or  to change the unit between Centigrade (°C) and Fahrenheit (°F).
- **Reset:** Power off the fridge, holding the setting button  until E1 is displayed on the screen. Hold the button  and  until the screen lights up as follow:



5.APP Connection



Scan the QR Code with your smartphone or search it in the APP Store or Google Play to download the "QZsmart" app.

PREPARATION BEFORE USE:

1. Make sure your car fridge is on and ensure that your smartphone is connected to 2.4 GHz Wi-Fi network.

NOTE: This device works only on 2.4 GHz Wi-Fi® network.

2.Ensure that the Bluetooth function of the mobile phone is enabled at the same time; otherwise, the device cannot be automatically searched.

3. Download the QZsmart app from the App Store or Google Play™.

NOTE: Authorize the app to access network and location services.

4. If you are using the app for the first time, click the "Sign up" button and register. If you already have an account, click the "Log in" button.

5. For better WIFI connection, please reset the product WIFI before using it for the first time. You can disconnect the connection by turning off the switch of the refrigerator and simultaneously long pressing **+** and **-** on the control panel of the refrigerator for 3 seconds and hearing one beep.

Add Device

1. From the Home Page, press "Add Device" or press **+** in the top right corner of the screen. (If you already have a device added to your account, the "Add Device" button will not appear).

2. Connecting

■ Auto-connect:(Featured First)

The app will automatically search when Wi-Fi and Bluetooth are switched on, so you can add the corresponding product directly from the automatic search.

Step 1:Press "Add Device" or press **+**.

Step 2:When the device is found, press Add. The Bluetooth function must be enabled during this process.

Step 3:Select your Wi-Fi network. (Be sure to use a 2.4G network)

Step 4:Enter your router password.

Step 5:Wait for connection and click "NEXT".

Step 6:Once the device is added, you can use the menu to change the name and location of the device.

Step 7:When you are finished, click "Done".

■ Manual connection: Select your model from the device menu.

Step 1:Press "Add Device" or press **+**.

Step 2:Select the corresponding product type and click the product diagram of the corresponding model.

Step 3: After the product is shut down, press "Next".

Step 4: Long pressing "+" and "-" on the control panel of the refrigerator for 3 seconds and hearing one beep, Press "Next".

Step 5: Select your Wi-Fi network. (Be sure to use a 2.4G network)

Step 6: Enter your router password.

Step 7: Click "Confirm." The next screen will say "Connect your mobile phone to the device's hotspot."

Step 8: Click "Go to connect." This will take you to your phone's settings (or Wi-Fi list for Android).

Step 9: Select "SmartLife-XXXX."

Step 10: Navigate back to the QZsmart App.

Step 11: Click "Next." Your smartphone will automatically connect.

Step 12: Once the device is added, you can use the menu to change the name and location of the device.

Step 13: When you are finished, click "Done."

■ Follow the APP interface, there are detailed operation reminders in the APP interface, you need to follow the steps one by one.

NOTE: Connection may take up to 60 seconds.

*Once the device is added, you can use the menu of the app to change the name of the device.

*When you finished, press "Done".

NOTE: Your mobile device is connected to a 2.4GHz Wi-Fi network when pairing with the app. Please select the 2.4GHz network when selecting a Wi-Fi network on the app during setup.

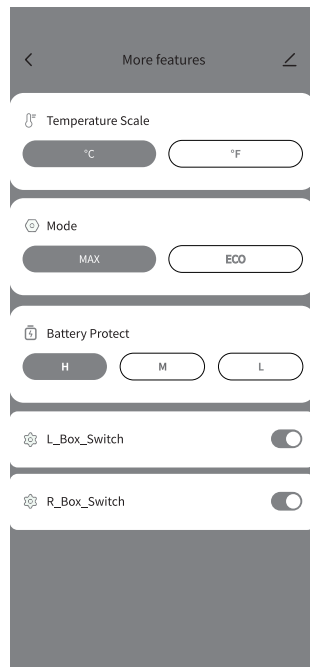
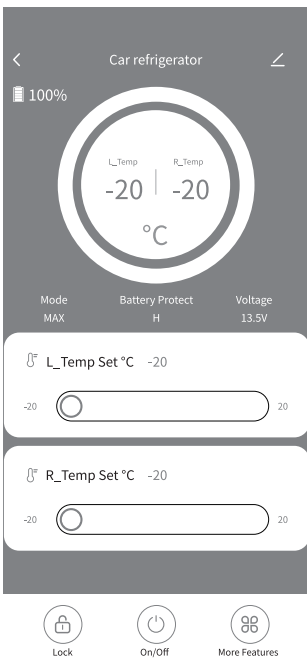

Using the My App

The main interface can control the temperature of 2 compartments respectively; Set up the "LOCK"; Refrigerator switch.

Click on "more features" in the lower right corner to set the switch of temperature unit, cooling mode, battery protection mode and refrigerator compartment.

How to unbind

A car refrigerator can only be connected to one mobile phone.

First method: You can disconnect the connection by turning off the switch of the refrigerator and simultaneously long pressing **+** and **-** on the control panel of the refrigerator for 3 seconds and hearing one beep.

Second method: Removing connection with the app: Open the app and go to the device page. Click "☒" in the upper right corner, and then click "Remove Device" at the bottom.

Cautions

*There will be a delay in operating the machine on the mobile phone, about 1-3 minutes, please be patient.

*The language of the APP automatically switches with the language of the mobile system.

*You can lock or unlock the control panel on the refrigerator by operating the APP lock icon. Please note that if you want to lock the refrigerator, please control it through the APP, the operation panel of the refrigerator does not have the function of locking and unlocking.

*This product includes WIFI plus Bluetooth function. Bluetooth function can be used in non-wifi environment. If you need to use Bluetooth function, please be sure to connect WIFI , successfully for the first time. (Again, you must connect to WIFI first, otherwise you will not be able to use Bluetooth in non-wifi environments.)

6. Cleaning and Storage

■ Cleaning:

1. Please unplug the fridge first to avoid electric shock.
2. Do not soak the fridge in water and do not wash it.
3. Remove the cover and drain from the hole.
4. Use wet cloth to clean the fridge and dry it.

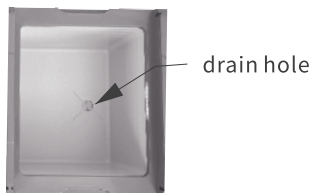

■ If you do not use the refrigerator for a long time, please follow the instruction:

1. Turn off the power and remove the plug.
2. Remove the items stored in the refrigerator.
3. Absorb all the water in fridge with dry cloth.
4. Place the fridge in a cool and dry place.

7.Troubleshooting

PROBLEM	POSSIBLE CAUSE	SUGGESTED SOLUTIONS
The refrigerator is not working	The power is cut off	<ul style="list-style-type: none"> • Check if power supply is malfunctioned or not. • Check whether the plug and socket are connected well. • Check whether the fuse has been burnt or not. • Check if the switch is on or not.
Food is frozen	The setting temperature is too low	Increase the setting temperature
Water flowing sound is inside the refrigerator	It is a normal phenomenon.	It is the flowing sound of refrigerant which is normal.
There are water drop around the refrigerator casing or door gap	It is a normal phenomenon.	When moisture in the air meets the lower temperature refrigerator casing, it will naturally become liquefied and condensed to be water drops. That is a normal phenomenon.
The compressor is slightly noisy when starting	It is a normal phenomenon.	The noise will be less after the compressor works stably.
Code F1 displayed	This is protection mode of low car voltage	Set the battery protection button from H to M or from M to L
Code F2 displayed	This is the protection mode of overloaded fan	Turn the refrigerator off and restart it after 30mins.
Code F3 displayed	This is the protection mode of frequent working compressor.	Turn the refrigerator off and restart it after 30mins.

Code F4 displayed	It means compressor is overloaded or working at a low speed.	Turn the refrigerator off and restart it after 30mins.
Code F5 displayed	This is the protection code of overheated compressor module.	Move the refrigerator to a ventilated area, turn it off and restart it after 30mins
Code F6 displayed	No parameter can be detected by the controller.	Please restart it. If the code shows again, please contact with after-sale workers.
Code F7 or F8 displayed	This is the erroneous protection code of temperature sensor.	Please check the sensor terminal.

8. Technical Data

MODEL	TWW75	TWW95
RATED VOLTAGE	DC12/24V or AC100~240V(using dedicated adapter)	
RATED POWER	80W	
CAPACITY	75L/2.7cu.ft.	95L/3.4cu.ft.
NOISE	≤45dB	
TEMPERATURE SETTING RANGE	-20~20°C (-4~68°F)	
CLIMATE CATEGORY	T/ST/N/SN	
DIMENSIONS(L*W*H)	937*535*465mm 36 7/8 *21 1/16 *18 5/16inch	1005*571*465mm 39 9/16 *22 1/2 *18 5/16inch
NET WEIGHT	25.65kg/56.55lb	28kg/61.7lb

*Due to product improvement, the technical data might be different from actual data, please refer to the rated label on the product.



BODEGA

Thank you for purchasing **BODEGA** COOLER product. We sincerely hope that you are satisfied with the product.

We'd like to offer you **12-month warranty** for free.

Once activated the warranty, you will be ensured that if anything goes wrong with your product. Replacement unit/parts will be warranted during the warranty period.

———— **What you need to do** ————

Any help or questions during use, please contact us via website

www.bodegacooler.com, send email to **info@bodegacooler.com**,

we will service you within 24 hours.

When contacting us, we suggest to send Order ID,

problem and a photo or a video for helping us much

more clearer about the problem and offer you the best solution.