

■ This manual contains important information including safety and installation instructions of the appliances. Please read it carefully before use and follow all safety information & instructions. It is recommended to keep this manual for easy reference so that you can be familiar with the operation of the appliance.

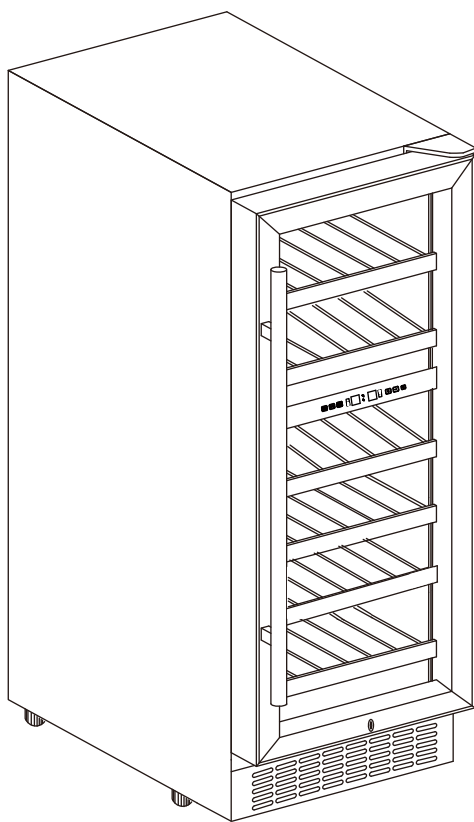

INSTRUCTION MANUAL COMPRESSOR WINE COOLER



YC-100B



YC-150B

CONTENTS

IMPORTANT SAFETY INFORMATION.....	P.3
STRUCTURE AND INSTALLATION DRAWING.....	P.4
ACCESSORY INSTALLATION BEFORE OPERATING.....	P.5
OPERATING THE WINE COOLER.....	P.9
CARE AND MAINTENANCE.....	P.11
TROUBLESHOOTING.....	P.12
WARRANTY.....	P.13

MANUFACTURER:Zhongshan YEHOS Electrical Appliance Co., Ltd

No. 9, Yuan lin Rd, Nantou Town,Zhongshan city, Guangdong province, China

Contact: Tracy Tel: +8618680277793 E-Mail: logistic01@iaobosi.com

IMPORTANT SAFETY INFORMATION

Before use the appliance, please properly position and install it as described in this manual. To avoid the risk of fire, electrical shock, or injury when using the appliance, follow these basic precautions:

- the appliance is intended to be used exclusively for the storage of wine.
- Make sure the voltage/current marked on the rating label corresponds with your supply voltage. Plug into a grounded 3-pin outlet, do not remove grounding pin, do not use an adapter, and do not use an extension cord.
- It is recommended that a separate circuit is provided for serving only your appliance be provided.
- Never clean the appliance parts with flammable fluids which may create a fire hazard or explosion. And do not store or use gasoline or other flammable vapors and liquids in the vicinity of the appliance.
- Do not connect or disconnect the electric plug when your hands are wet.
- Unplug the appliance or disconnect power before cleaning, maintenance or servicing. Failure to do so can result in electrical shock or death.
- Do not attempt to repair or replace any part of the appliance unless it is specifically recommended in this material. All other servicing should be referred to a qualified technician.
- Ensure enough peoples to move and install the appliance to avoid any damage to the appliance or injury to the peoples.
- To ensure proper ventilation for the appliance, the front of the unit must be completely unobstructed. Locate the unit away from direct sunlight and sources of heat (stove, heater, radiator, etc.).
- The fuse (or circuit breaker) size should be 10 amps or higher.
- It is important for the appliance to be leveled in order to work properly. You may adjust the appliance's feet to level it.
- This appliance is not intended for use by young children. Never allow children to operate, play with or crawl inside the appliance.
- Do not use solvent-based cleaning agents or abrasives on the interior. These cleaners may damage or discolor the interior.
- Do not use this appliance for other than its intended purpose.
- The use of attachments which is not recommended by the manufacturer may be hazardous.
- When you dispose the appliance, take off the door and leave the shelves in place so that children may not easily climb inside. And make sure the coolant circuit, particularly the heat exchanger at the back/bottom of the unit not be damaged. The  symbol on the product or its packaging indicates that this product is not to be handled as normal household waste and it is to be taken to a recycling collection point for electrical and electronic goods.

STURCTURE AND INSTALLATION DRAWING

The following pictures only show the structure of the appliance as well as the installation drawing. The dimension and shelf quantity may differ among the models of the same series.

BUILT-UNDER SERIES (Built under a kitchen table top)

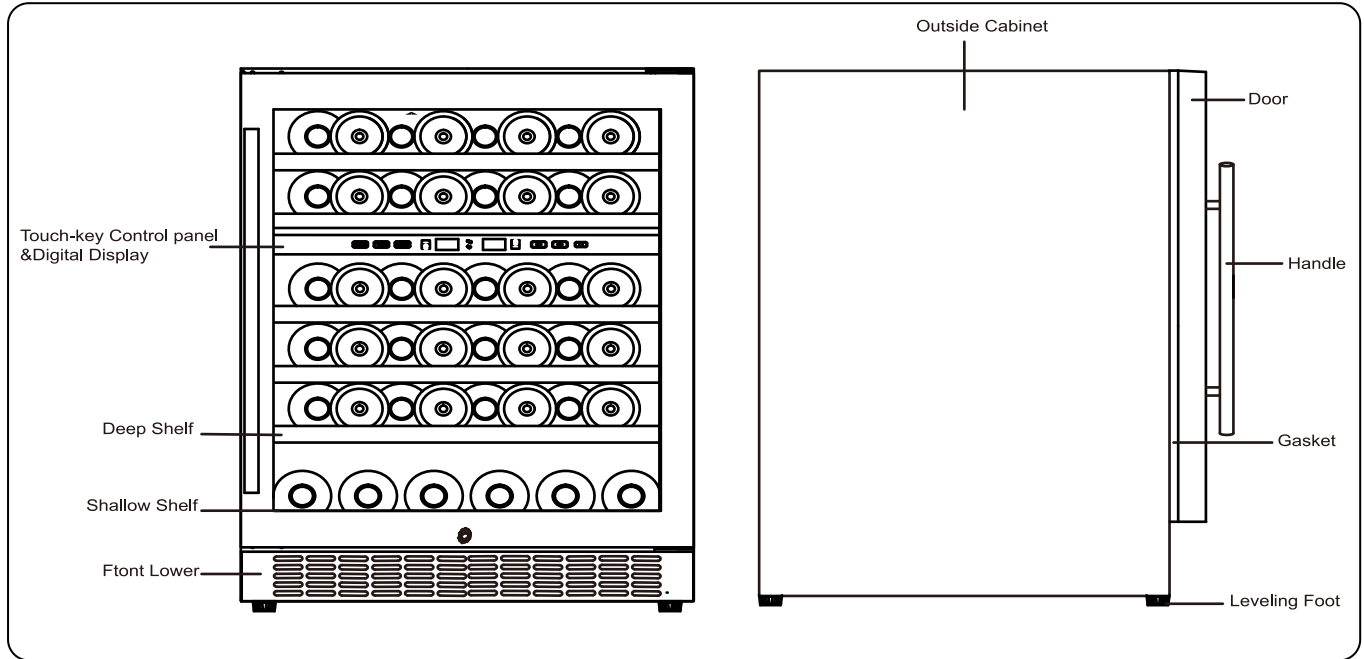

YC-150B Installation Drawing (mm/inch)

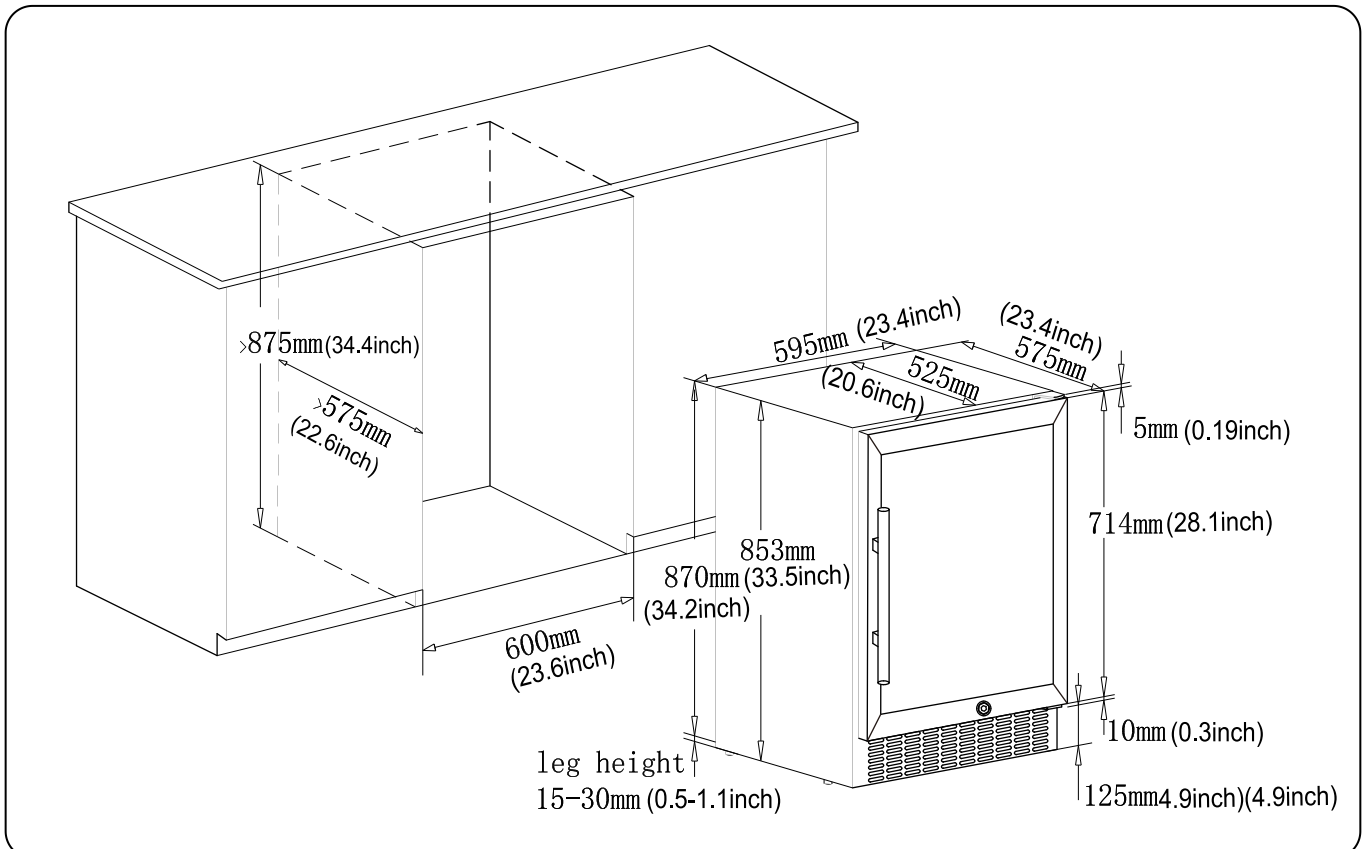

YC-100B Installation Drawing (mm/inch)

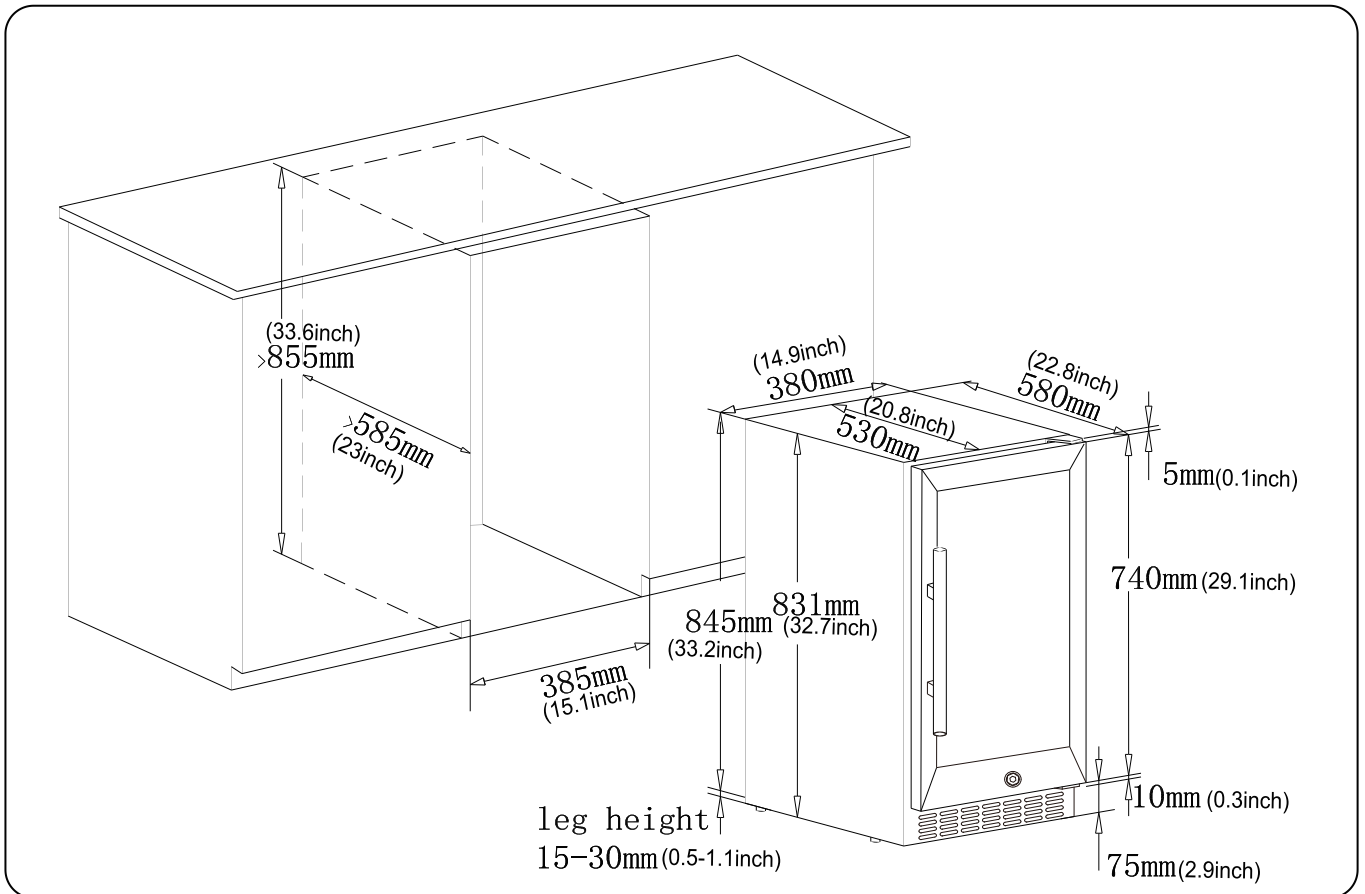

ACCESSORY INSTALLATION BEFORE OPERATING

UNPACKING AND CLEANING THE WINE COOLER

- Remove the exterior and interior packing materials.
- Let the appliance stand upright for approximately 24 hours before connecting it to the power source, which helps to reduce the possibility of a cooling-system malfunction from handling during transportation.
- Use a soft cloth to clean the interior surface with lukewarm water.
- Install the door handle provided with the appliance by following these steps:

1st step — Remove the gasket at the inner side of the door to expose the two screw holes.

2nd step — Install the handle tightly with the screws and washers provided.

3rd step — Tidy and restore the gasket.

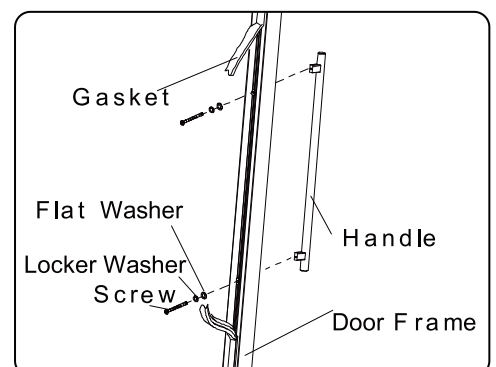

LOCK & UNLOCK THE DOOR (FOR OPTION)

- Lock is an optional function. If your Wine Cooler has such function, a key should be attached inside the packing of this Manual.
- Insert the key into the lock and turn it counter-clockwise to unlock the door. To lock it, please follow the reversed operation. Please save the key well.

WORKING CLIMATE

- The appliance is designed for operating from SN to T climate (see below climate class chart). It is recommended to maintain the ambient around 22-25°C/71.6-77°F which helps the appliance working with low power consumption.
- If the ambient temperature is above or below the designed climate range, the performance of the unit may be affected. For example, the appliance operating in extreme cold or hot conditions may cause interior temperatures to fluctuate, and the temperature set 5-18°C/41-64.4 °F may not be reached sometimes.

Climate Class	Ambient Temp.
SN	10 - 32 °C/50-89.6°F
N	16 - 32 °C/60.8-89.6°F
ST	18 - 38 °C/64.4-100.4°F
T	18 - 43 °C/64.4-109.4

WINE BOTTLE STORAGE DIAGRAM

Model	Description
YC-100B	28 bottles dual zone wine cooler
YC-150B	46 bottles dual zone wine cooler

The standard bottles as below:

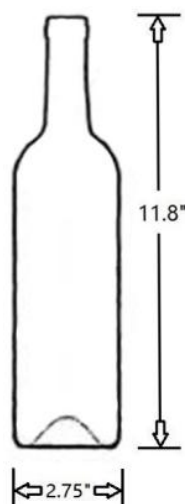

The stated capacity is dependent on the size and shape of standard Bordeaux 750ml bottle with diameter of 2.75".

When accommodating larger bottles, you can remove shelves. This will reduce the stated bottle capacity.

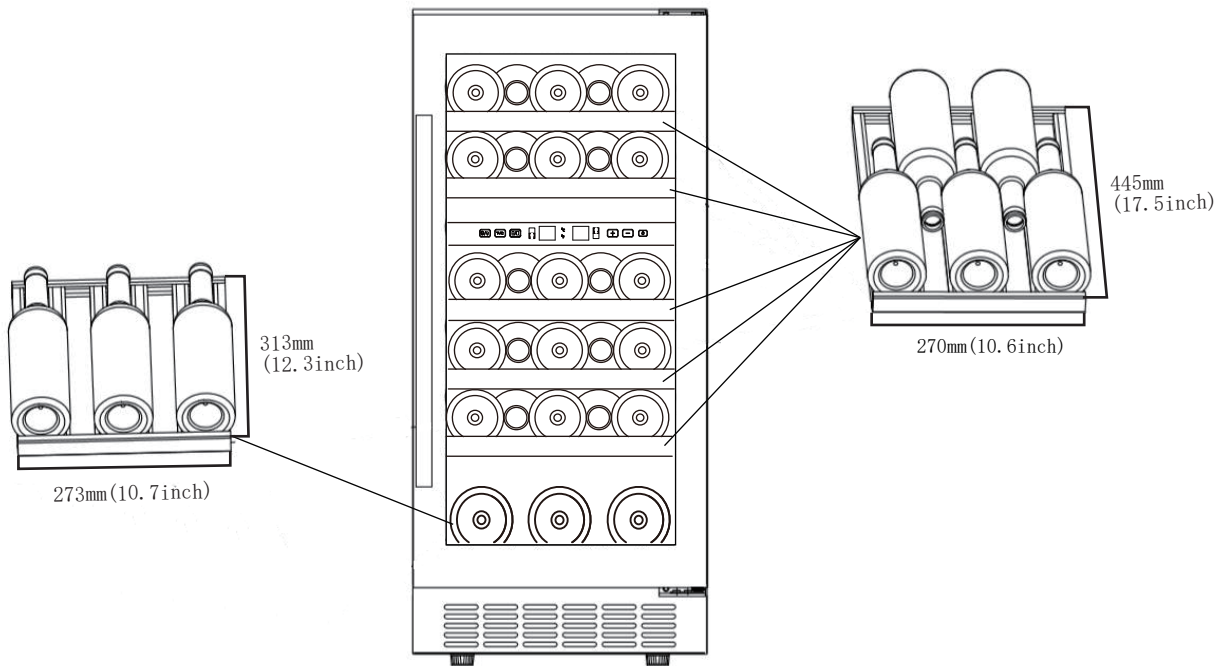

Storage of Model YC-100B

- Shelf One To Five - 5 bottles per shelf
- Bottom Section - 3 bottles

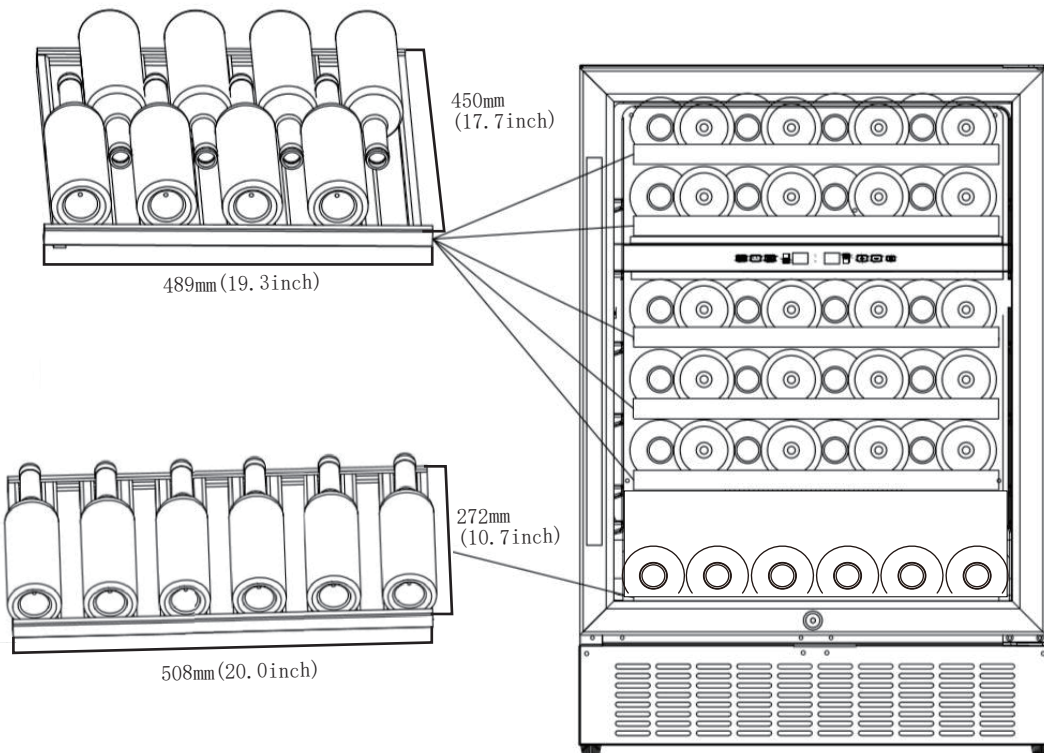

Storage of Model YC-150B

- Shelf One To Five - 8 bottles per shelf
- Bottom Section - 6 bottles

WINE STORAGE

- The standard shelves are designed perfectly for Bordeaux bottle storage. The maximum loaded bottles may vary subject to the different size or dimension of the wine bottles you store, as well as the shelves quantity pre-installed in the Wine Cooler.

How to remove the shelf.

●To avoid the damage of door sealing, please open the door fully when you slide out the shelves.

●For your convenience of taking wine, you can pull out the shelf by 1/3. Our product is designed with shelf holder to prevent the shelf pull over and fall off the cabinet.

●If you need to take off the shelf from cabinet, you can pull out the shelf to the position where the notch of shelf is exactly under the plastic post and then lift it up and out. (See figure below)

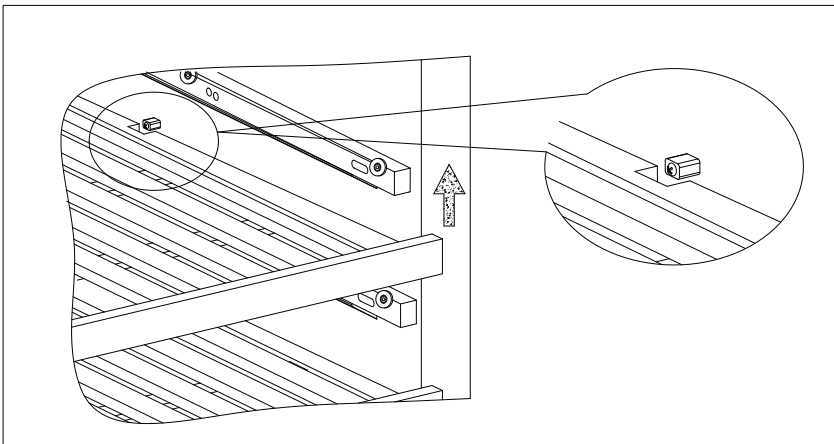

- Please store wine in sealed bottles.
- Should the wine cooler be left empty for long periods it is suggested that the appliance is unplugged, and after careful cleaning, leave the door ajar to allow air to circulate inside the cabinet in order to avoid possible condensation, mold or odours forming.
- Please store wine in sealed bottles.
- Should the wine cooler be left empty for long periods it is suggested that the appliance is unplugged, and after careful cleaning, leave the door ajar to allow air to circulate inside the cabinet in order to avoid possible condensation, mold or odours forming.
- Recommended Temperatures for chilling/storage your wines.

Red Wines	15 - 18° C/41-64.4°F
Dry/White Wines	9 - 14° C/48.2-57.2°F
Rose Wines	10 - 11° C/50-51.8°F
Sparkling Wines	5 - 8° C/41-46.4°F

OPERATING THE WINE COOL

OPERATION

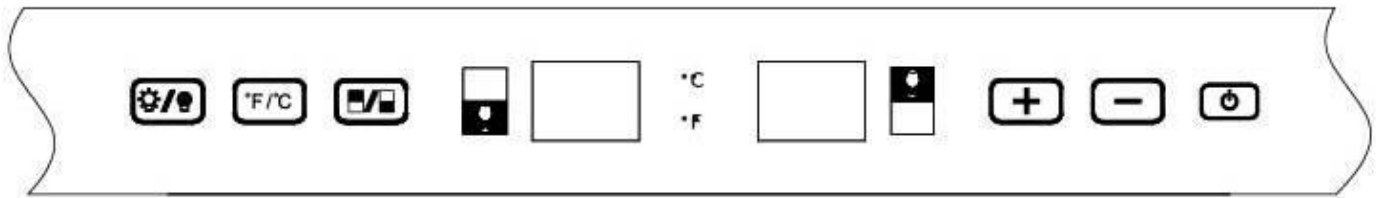

POWER ON/OFF

- When the appliance is plugged into a power outlet, it powers on automatically.
- Touch the power mark  to turn on (or turn off) the appliance if you need.



Warning:





To avoid breaking the compressor, please do not turn on the appliance again within **5 Minutes** after you turn it off.

INTERIOR LIGHTING ON/OFF CONTROL

- Touch the lighting mark  to turn on (or turn off) the interior cool LED lighting.
- The light will automatically turn off 10 mins later for energy saving.

Note: To keep the light staying on always, please press the lighting mark  until you hear 2 “beeps”.

SET TEMPERATURE (Upper zone and Lower zone)

- Touch the  button once to select the lower zone and once more to select the upper zone. The numbers in the display window of the selected zone will flash.
- Touch the  or  button to increase or decrease the temperature of the selected zone. The temperature will increase 1°F or 1°C if you touch the  button once; On the contrary the temperature will decrease 1°F or 1°C if you touch the  button once.

Tips:

- When you store mostly red wines, the temperature needs to be set at 15°C-18°C (59°C-64.4°F).

- When you store mostly white wines, the temperature needs to be set at 9°C-14°C (48.2°F-57.2°F).
- When you store mostly sparkling wines, the temperature needs to be set at 5°C-8°C (41°F-46.4°F)

Note: The temperature inside the unit will be appeared in blue color in the display window.

Notice:

For the first time to use the appliance or to restart the appliance after having been shut off for a long time, you may find a few degrees variance between the set temperature and the displayed temperature. It is normal and everything of the appliance will be in the order after a few hours running.

TEMPERATURE DISPLAY WINDOW

- The temperature is displayed in digital which is the best way to be read out. The digital is shown as the set temperature when you are setting the temperature, and it will change to be the real temperature of the inside cabinet after 5 seconds without being touched.

Model	Temperature range
YC-100B	Upper zone:5°C-13°C(41°F -55.4°F)
YC-150B	Lower zone:13°C-18°C (55.4°F -64.4°F)

 **Warning:**

When the temperature probe is out of order, the display window will show with “HH” or “LL” instead of a digital figure while continuous buzz sound will be heard.

To avoid destroying your stored wines, it is strongly recommended to have the appliance repaired immediately.

SELECTING FAHRENHEIT(°F) & CELSIUS (°C)

Touch the  button, you can interchange the Fahrenheit (°F) and Celsius (°C) display.

CARE AND MAINTENANCE

CLEANING THE WINE COOLER

- Turn off the power, unplug the appliance, and remove all items including shelves.
- Wipe the inside surfaces with a sponge and baking soda solution. The solution should be about 2 tablespoons of baking soda to a quart (approx. 1 litre) of warm water.
- Wash the shelves with a mild detergent solution. Allow wooden shelves to dry before placing back into the wine cooler.
- Wring excess water out of the sponge or cloth when cleaning area of the controls, or any electrical parts.
- Wipe the outside cabinet with warm water and mild liquid detergent. Dry with a clean soft cloth.
- Do not use steel wool or steel brush on the stainless steel. These will contaminate the stainless steel with steel particles and rusting may occur.

POWER FAILURE

Most power failures are corrected within a few hours and should not affect the temperature of your appliance if you minimize the number of times of door opening. If the power is going to be off for a longer period of time, you need to take the proper steps to protect your contents.

MOVING THE WINE COOLER

- Remove all items.
- Securely tape down all loose items (shelves) inside your appliance.
- Turn the adjustable leg up to the base to avoid damage.
- Tape the door shut.
- Be sure the appliance stays secure in the upright position during transportation. Also protect outside of appliance with a blanket, or similar item.

ENERGY SAVING TIPS

- The appliance should be located away from heat producing appliances, and away from direct sunlight.
- Ensure that the unit is adequately ventilated. Never cover air vents.
- Only open the door when necessary. Avoid leaving the door open for long periods or opening/closing the door frequently.

Technical Specification

Brand	AOBOSI	AOBOSI
Wine & Beverage	YC-100B	YC-150B
Total Volume	3.53Cu.Ft.	5.30Cu.Ft.
Power	115V~60Hz	115V~60Hz
Amps	1A	0.9A
Start-Up Amps	10A	10A
Power Input	81W	75W
Pressure High Side	105 PSI	105 PSI
Pressure Low Side	55 PSI	55 PSI
Refrigerant	R600a	R600a
Amount	0.74 oz.	0.82 oz.
Dimensions(HxWxD)	33.5"x15"x23"	34.25"x23.43"x22.64"

TROUBLESHOOTING

If you feel the appliance is out of order, follow these instructions to try to see if you can solve the problem simply by yourself before calling for service.

PROBLEM	POSSIBLE CAUSE / MEASURE
The Wine Cooler does not operate	<ol style="list-style-type: none"> 1. Not plugged in. 2. The appliance is turned off. 3. The circuit breaker tripped or a blown fuse.
The Wine Cooler is not cold enough	<ol style="list-style-type: none"> 1. Check the temperature control setting. 2. External environment may require a higher setting. 3. The door is opened too frequently. 4. The door is not closed completely. 5. The door gasket does not seal properly.
The compressor automatically turns on and turns off frequently	<ol style="list-style-type: none"> 1. The room temperature is hotter than normal. 2. A large amount of contents has been added to the Wine Cooler. 3. The door is opened too frequently. 4. The door is not closed completely. 5. The temperature control is not set correctly. 6. The door gasket does not seal properly.
The lighting does not work	<ol style="list-style-type: none"> 1. Not plugged in. 2. The circuit breaker tripped or a blown fuse. 3. The lighting is turned off.
Too much vibration	<ol style="list-style-type: none"> 1. Check to assure that the appliance is level. 2. Check to assure no parts inside the cabinet or in the compressor chamber are loose.
The Wine Cooler seems to make too much noise	<ol style="list-style-type: none"> 1. The rattling noise may come from the flow of the refrigerant, which is normal. 2. As each cycle ends, you may hear gurgling sounds caused by the flow of refrigerant. 3. Contraction and expansion of the inside walls may cause popping and crackling noises. 4. The appliance is not level.
The door will not close properly.	<ol style="list-style-type: none"> 1. The wine COOLER is not level. 2. The door was reversed and not properly installed. 3. The gasket is dirty. 4. The shelves are out of position.
The display window is shown with "HH" or "LL" instead of a digital figure, and/or with continuous buzz sound.	The temperature probe is out of order.

WARRANTY

Thank you for choosing AOBOSI product. We sincerely hope that you are satisfied with it. The manufacturer's warranty covers the product for a period of 12 months from the date of purchase against manufacturing faults. All warranties are automatically kept track of in our system, so there is no need to register your product.

Agent/Distributor is welcome to contact us. Email:info@iaobosi.com.

Any help or questions during use, please contact us via website www.iaobosi.com, send email to info@iaobosi.com, we will service you within 24 hours. We suggest to provide a warranty card, a photo or a video if there's broken spare part or not working machine so that we can be much more clear about your problems and offer you the best solution.



 **aobosi** Warranty Card

Item name: _____

Model: _____

Serial No.: _____

Store name: _____

Purchase date: _____

Buyer's name: _____

Email: _____

Address: _____

Tel.: _____

Please fill in the table and email it within 10 days from the date of purchase.