

CASIRIS A6

4K LASER CINEMA USER MANUAL

———— LHT-X2A/LHT-X2B/LHT-X2E ————

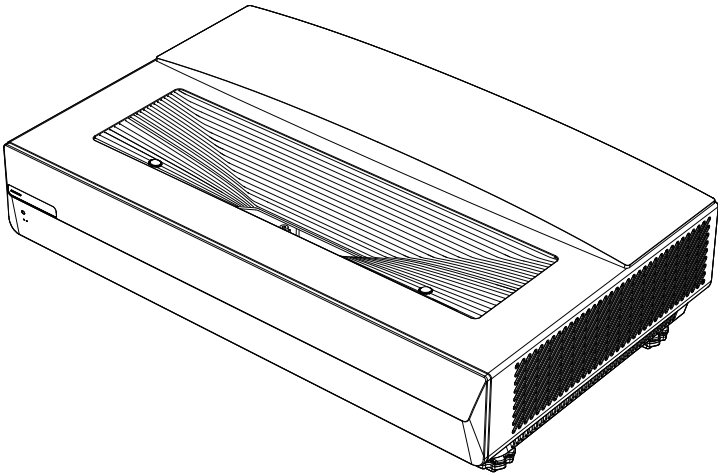

www.casiristech.com

Please read this instruction carefully
before using the product and keep it properly

English	01
Deutsch	32
Français	63
Español	94
Italiano	125

TIPS

Hello! Before using this product, please read the product manual carefully and keep it properly. The company does not assume any responsibility for accidents caused by violation of safety precautions and instructions in this manual.



This is a high-voltage product, users are not allowed to open the case without authorization. Non-professional maintenance personnel shall not repair or replace without authorization to avoid electric shock and fire accidents.



Energy Conservation Tips

When the machine is not in use, please select AC shutdown (disconnect the power plug) after standby to reduce energy consumption.

Warning: This product is a Class II equipment and does not need to be grounded.

Symbol Explanation



The triangle pattern with the lightning arrow is a warning symbol to remind you that the voltage inside the product is dangerous.







The triangle pattern with the exclamation mark is a warning symbol which remind you of important instructions related to the product.

Important Notes

Please read the following carefully before using this product:

1 Safety Warning

-  When encountering thunderstorm, please unplug the power plug to avoid damage to the unit.
-  Main plug on the power cord is used as the disconnect device, the disconnect device and socket-outlet shall be easily accessible.
-  If you do not use this product for a long time, please unplug the power plug. Do not pull on the power cord when unplugging.
-  If you find any abnormal sound or smell, or sound but no image, please turn off the power immediately and unplug the power plug from the socket, and contact service@casiristech.com as soon as possible.

- Please do not let any objects press the power cord and signal cord.
- Please do not overload the power socket and make sure that the socket you use is a qualified product that has passed the national safety certification.
- Do not place exposed flame sources, such as lighted candles on the machine, and keep it away from objects with high temperature and heat.
- Do not expose this machine to water droplets or splashes, and do not place any objects filled with liquids, such as vases, cosmetics or liquid medicines, etc.
- If foreign matters or liquid fall into the machine, please unplug the power plug immediately and contact service@casiristech.com as soon as possible.
- Beware of children standing on or climbing on the machine.
- After the machine is moved from a low-temperature environment to a warm area, condensation may form inside the machine. To make the condensation dry inside the machine, it should be left for 24 hours before being powered on.
- Do not look directly at the lens after turning on the camera. The strong light from the lens may harm your eyes.
- Please do not expose the battery to excessive heat such as sunlight or fire, otherwise there is a danger of explosion.

2 Precautions for Installation and Placement

- The machine should be placed in a flat and stable place, please do not put it in a vibration place.
- Please do not place the machine in high-temperature places such as direct sunlight or heating devices, or in places where water, oil and smoke can easily enter the machine, or where there is much dust and humidity.
- Please do not place the machine in poorly ventilated or enclosed places.
- When the surface of the cabinet is sprayed with paint or organic solvents and greases, the rubber pad of the base may have a slight chemical reaction with it, causing slight corrosion on the surface of the cabinet, therefore, it is recommended that users put a layer of protective material (such as cardboard or glass plate, etc.) on the case before placing the machine.
- When moving the machine, it is recommended that two or more people load, unload, and carry it. Avoid shocks during the movement and protect the light microscope of the machine.

The engineering plastics, internal transformer insulating paint, rubber parts, etc. Used in the newly purchased product shell will emit a certain smell like newly purchased furniture, as the temperature rises, the smell will be more pronounced.

- These smells are determined by the composition of the material. The material solution we use fully meets the national environmental protection regulations, so consumers can use it with confidence.
- The smell will gradually decrease with the use of the machine and eventually disappear. Please keep the environment ventilated.
- Do not block the ventilation openings or place debris on the machine to ensure good heat dissipation. Do not place the machine in a small, closed space that is not conducive to air circulation.
- Install as shown in the figure, leaving a ventilation space around the machine.

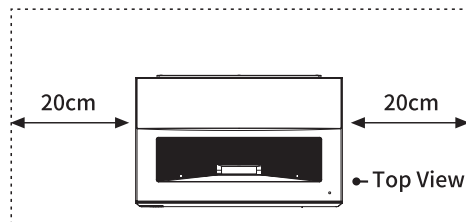

Please at least leave this space around the machine.

- Do not install this machine as shown in the figure below.

Insufficient ventilation space can overheat the unit, and may cause damage to the unit or even fire.

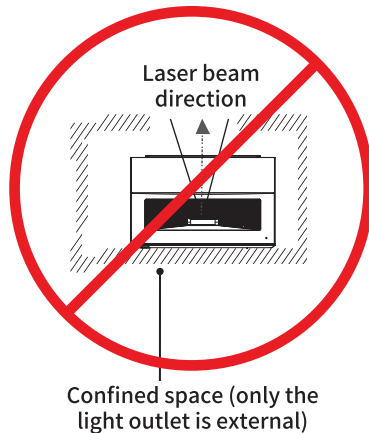

3 Precautions for Use

- ⚠ Please do not try to decompose, disassemble, repair any part of this product by yourself. This may cause damage to the product and personal injury, and invalidate the product warranty you enjoy.
 - ⚠ If the machine is dirty, please unplug the machine and wipe it with a soft semi-dry cloth dipped in a small amount of diluted neutral detergent, but do not wipe it repeatedly to avoid scratches. Do not use solvents such as alcohol, gasoline, acid, alkali, detergent, volatile oil, thinner, etc. to clean the machine. These solvents may deteriorate the material or damage the painted surface.
 - ⚠ If rubber or vinyl products are in contact with the machine for a long time, it may cause stains.
 - ⚠ Please do not wipe the light microscope directly with your hands, ordinary cleaning paper or cleaning cloth. For oil stains and fingerprints, please ask professionals to use optical cleaning cloth or lens cleaning paper and professional cleaning fluid to wipe carefully to avoid damage to the optical coating and affect the image quality.
 - ⚠ Please do not use sharp objects, metal to touch the signal connector or extend into the ventilation hole, so as to avoid the short circuit causing product damage or danger of electric shock.
 - ⚠ Please do not cover the machine with objects such as newspapers, tablecloths and curtains to obstruct the ventilation and affect the heat dissipation of the machine, otherwise it may affect the service life of the machine and may even cause safety accidents such as fire.
-
- Do not touch the machine when the machine is working or after cutting its power but the vent and top cover are still hot .
 - Do not directly cut off the power when the machine is working, if you need to shut down, please press the standby button of the remote control.
 - Keeping a proper watching distance, and the optimum distance is 1.5 times the diagonal length of the screen.
 - It's better to keep appropriate volume to avoid disturbing your neighbors, especially at night.

4 IMPORTANT INFORMATION ABOUT THE REMOTE AND BATTERIES

- Discard batteries in a designated disposal area. Do not throw them into a fire.
- Remove old batteries immediately to prevent them from leaking into the battery compartment.
- If you do not intend to use the remote control for a long time, then remove the batteries.
- Battery chemicals can cause a rash. If the batteries leak, clean the battery compartment with a cloth. If chemicals touch your skin then wash it immediately.
- Do not mix old and new batteries.
- Do not mix alkaline, standard (carbon-zinc) or rechargeable (NiCd, NiMH, etc.) batteries.
- Do not continue using the remote if it gets warm or hot.

5 Laser

The Laser safety parameters:

LASER RADIATION

DO NOT STARE INTO BEAM

CLASSE 1 LASER PRODUCT

MAXIMALE OUTPUT < 66.7 mW

$\lambda = 459-471\text{nm}, 519-531\text{nm}, 635-651\text{nm}$

IEC/EN 60825-1:2014

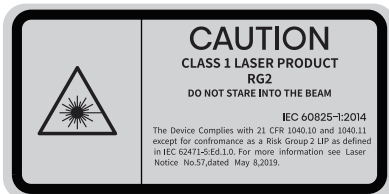
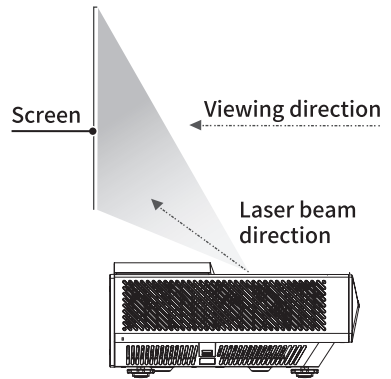

Warnings:

- This product contains a laser module, please do not disassemble or modify the machine with a manner not specified in the user manual, otherwise it may cause psysical injury.
- This laser belongs Class 1 product, please do not look directly at the laser beam. When repair the machine, please wear a laser protective goggles with an optical density of $OD \geq 4$, and a wavelength in the range of 440-660nm.

NOTE: This equipment has been tested and found to comply with the limits for a Class B digital device, pursuant to part 15 of the FCC Rules. These limits are designed to provide reasonable protection against harmful interference in a residential installation. This equipment generates uses and can radiate radio frequency energy and, if not installed and used in accordance with the instructions, may cause harmful interference to radio communications. However, there is no guarantee that interference will not occur in a particular installation. If this equipment does cause harmful interference to radio or television reception, which can be determined by turning the equipment off and on, the user is encouraged to try to correct the interference by one or more of the following measures:

- Reorient or relocate the receiving antenna.
- Increase the separation between the equipment and receiver.
- Connect the equipment into an outlet on a circuit different from that to which the receiver is connected.
- Consult the dealer or an experienced radio/TV technician for help.

Changes or modifications not expressly approved by the party responsible for compliance could void the user's authority to operate the equipment.

This device complies with Part 15 of the FCC Rules. Operation is subject to the following two conditions:

- (1) this device may not cause harmful interference, and
- (2) this device must accept any interference received, including interference that may cause undesired operation.

CONTENTS

Standard Accessories	08
Feet Adjustment and Display Calibration	08
Remote Control	15
Control Panel	17
Introduction of Terminal	19
Connection Instructions	19
Initial Startup	22
Others	23
Technical Specifications	28
Projector Distance & Size	29
Color adjustment	29
Audio output	30
Media output	30
Bluetooth	31

Standard Accessories

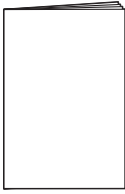

Operation Instruction



Remote Control

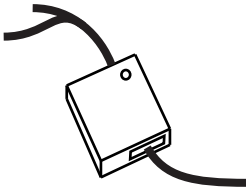

TV Dongle

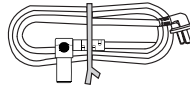

Power Cable

Feet Adjustment and Display Calibration

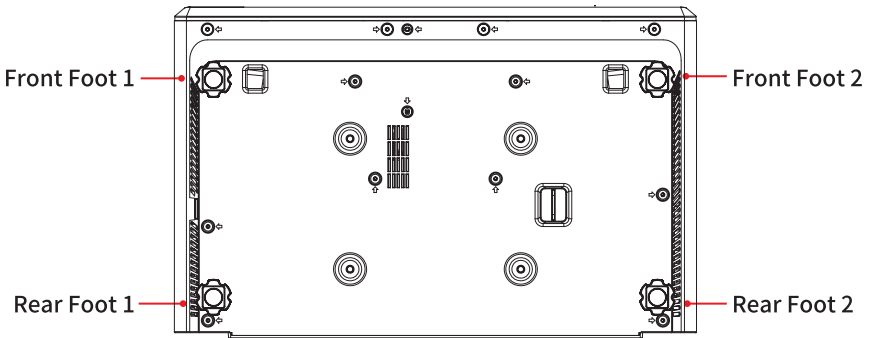

The Projector and the projection area require a flat surface to produce an even image. In most cases, a distorted image is caused by an uneven surface such as a curved or textured wall.

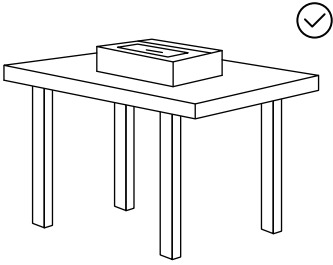

Flat surface

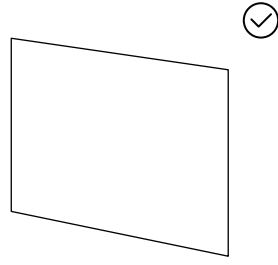

Flat surface

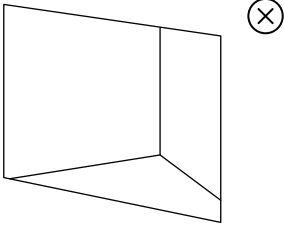

Curved wall

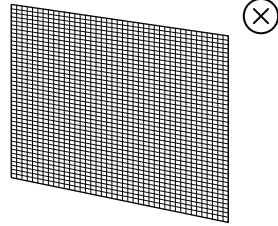

Textured wall

For optimal projection, it is recommended to use under a dark environment. An Fresnel Screen compatible with Ultra short Throw Projector is better.



Use Under A Dark Environment

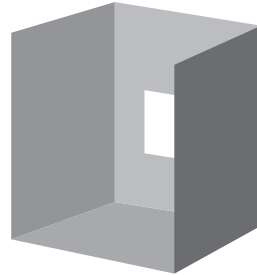

An ALR Screen is Better

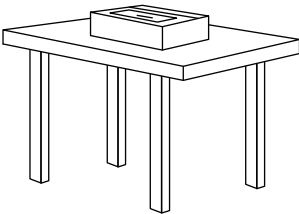

Adjust the Image to Fit on the Screen

Note: The rotation directions of the machine are explained by the low angle.

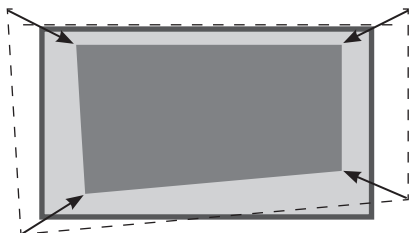

1. If the image is too large, please move the main unit forward.

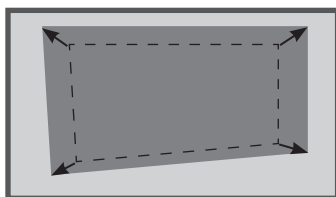

2. If the image is too small, please move the main unit backward.

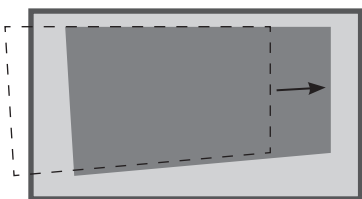

3. If the image is displayed to the left, please move the main unit rightward.

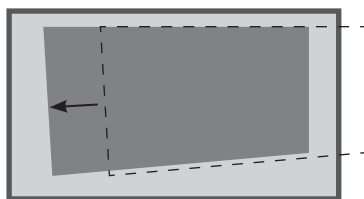

4. If the image is displayed to the right, please move the main unit leftward.

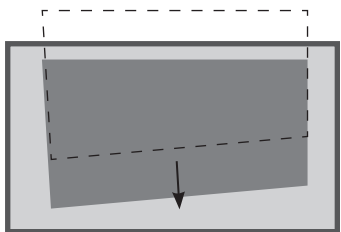

5. If the image is displayed on the upper side, please rotate the feet of the main unit clockwise.

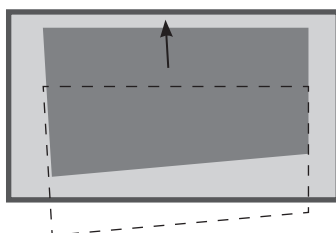

6. If the image is displayed on the lower side, please rotate the feet of the main unit counterclockwise.

Adjust Left/Right Widths of the Image

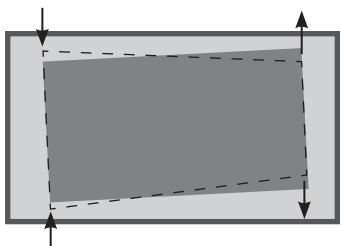

1. If image is displayed narrow in the left side, please rotate the main unit clockwise.

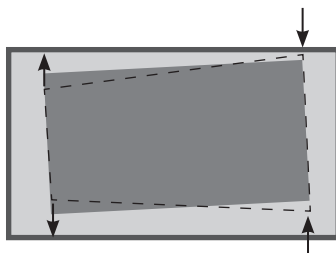

2. If image is displayed narrow in the right side, please rotate the main unit counterclockwise.

Adjust the Horizontal Line to Make the Image Parallel to the Screen

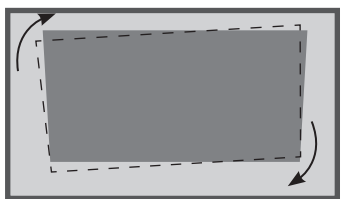

1. If the image is the left lower than the right, please rotate the front foot 2 and the rear foot 2 clockwise, and the front foot 1 and the rear foot 1 counterclockwise.

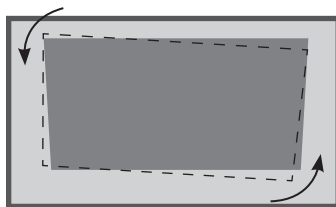

2. If the image is the left higher than the right, please rotate the front foot 2 and the rear foot 2 counterclockwise, and the front foot 1 and the rear foot 1 clockwise.

Adjust the Top and Bottom Width



1. If the image is the top wider than the bottom, please rotate rear foot 1/rear foot 2 clockwise or rotate front foot 1/front foot 2 counterclockwise.



2. If the image is the top narrower than the bottom, please rotate rear foot 1/rear foot 2 counterclockwise or rotate front foot 1/front foot 2 clockwise.

Enlarge the Image (Rectangle) to Fit the Screen Size



If the image is too small, please move the device backward.

Move the Image (Rectangle) to the Left



If the image shifts to the right side, move the device to the left.

Move the Image (Rectangle) to the Right



If the image shifts to the left side, move the device to the right.

Keep the Position



After adjusting the image to fit the screen, please keep the position still to avoid collision.

Methods of Typical Geometric Distortion Adjustment

Adjust the out-of-level Upper Left Corner

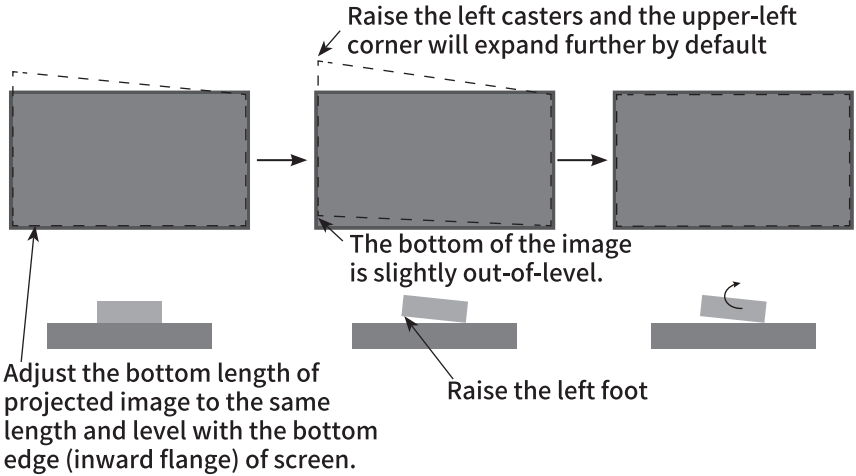

1. If the upper left corner is higher than the level, raise rear foot 1 and front foot 1 with the same elevation.
2. Rotate the laser projector clockwise to match the projected image with screen.
3. If the projection image out-of-level problem still exists after the adjustment, please further raise rear foot 1 and front foot 1 following above instructions, and rotate the laser projector clockwise to match the image with the screen.
4. If the upper left corner of the image enters the inner part of the screen after adjustment, it means that the feet are raised too much. In this case, lower the rear foot 1 and front foot 1 with the same elevation and rotate the laser projector clockwise to match the image with the screen.

Adjust the Out-of-Level Upper Right Corner

Raise the right caster and the projection angle will be out of level further.

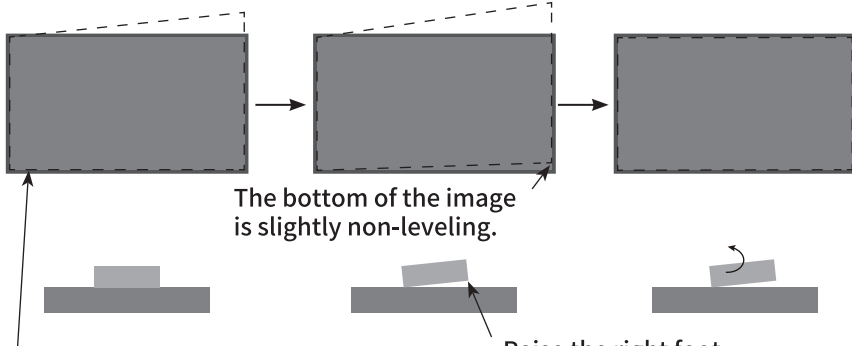

The bottom of the image is slightly non-leveling.

Adjust the bottom edge of projected image to the same length and level with the bottom edge (inward flange) of screen.

Raise the right foot.

1. If the upper right corner of the image is out-of-level, please raise rear foot 2 and front foot 2 with the same elevation.
2. Rotate the laser projector counterclockwise to match the projected image with screen.
3. If the problem still exists after adjustment, please further raise rear foot 2 and front foot 2 following instructions above, and rotate the laser projector counterclockwise to match the projected image with screen.
4. If the upper left corner of the image enters the inside of the screen after adjustment, it means that the feet are raised too much. In this case, lower the rear-foot 2 and the front-foot 2 to the same height and rotate the laser projector clockwise to match the projected image with the screen.

Remote Control

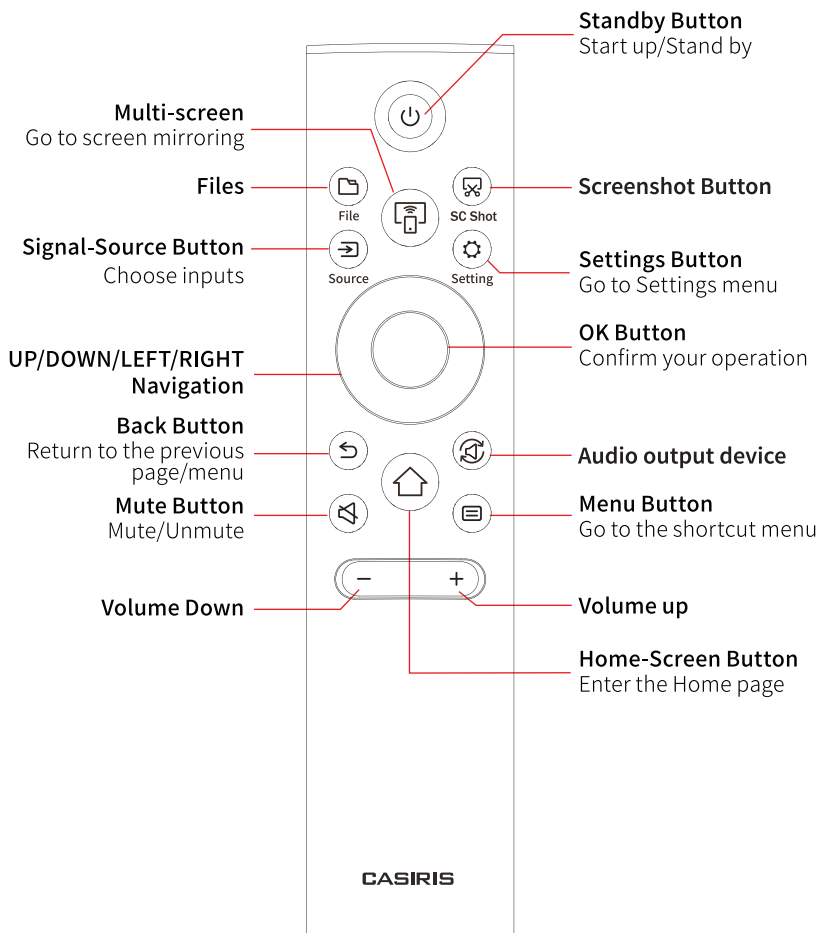

Instruction

- The remote control starts pairing when laser projector is on and within 3m from the laser projector.
- If the unknown error occurs to the remote control, it may be due to the interference of receiver signal. In this case, please eliminate the interference and repair the machine again.
- If the red indicator light flashes when you press remote control buttons, which means that the remote control fails to pair with the laser projector. In this case, press the Menu button for 3 seconds until the blue light flashes 3 times, which means it has been successfully paired.

How to Replace Batteries

1. Press and slide the back cover.
2. Insert two AAA alkaline batteries (1.5V). Make sure to match the (+) and (-) ends of the battery with the (+) and (-) ends indicated in the battery holder of remote control.
3. Put the cover on and slide until it is fully buckled.

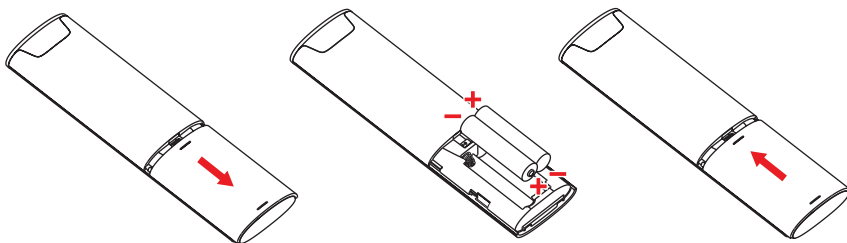

Effective Range

1. Remote Distance: The remote control is effective within 8m in front.
2. Remote Angle: Taking the laser projector remote receiving window as the vertex, the remote control can work at ± 30 degree horizontally and ± 15 degree vertically within 6 m away from the laser projector remote receiver

Additional Notes

1. As wireless devices, the signal of remote control and its receiver may be interrupted and blocked; And receiver signal may be weakened when laser projector is hung on the wall.
2. If unknown errors occur in the remote control when the battery power is normal, you can take out batteries and press the OK button for 5~10 seconds, then reinstall the batteries, and the remote can work normally.

Precautions

1. If the remote control cannot work normally or control the laser projector, please replace the batteries.
2. If the remote control will not be used for a long time or the batteries are exhausted, please remove the batteries. (Considering that waste batteries may pollute the environment, please dispose them properly.)

Control Panel

Left View



Ventilator Scoop

Front View

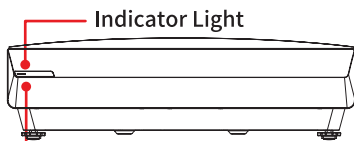

Remote Control Receiver Window

Right View

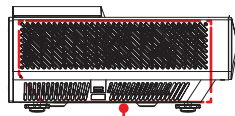

Ventilator Scoop

[Note]

There is a protective film on the ventilator scoop. Please remove it when first turn on the laser projector to avoid the damage to device.

Top View

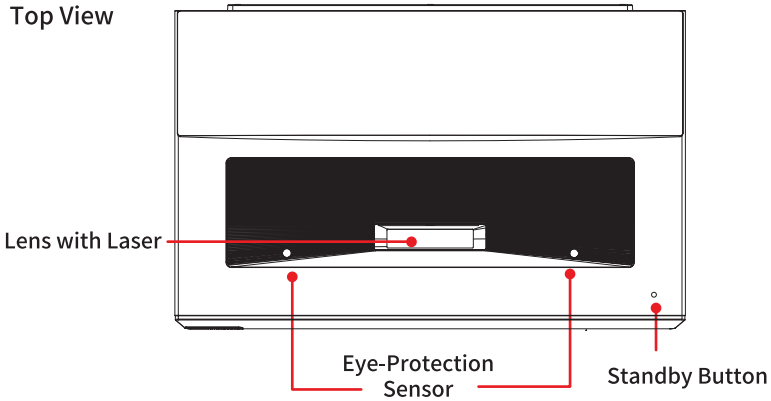

Name/Action	Function Description
Indicator Lights	The indicator turns white when the laser projector is turned on. When on standby mode, the standby light effect is set to on, and the white indicator light will flash for breathing; when the standby light effect is set to off, the white indicator light will turn off. The indicator light is set to flash red when it is faulty.
Remote Control Receiving Window	Receive the signal transmitted by the remote control through.
Eye Protection Sensor	When the eye protection function is turned on and the user approaches the eye protection sensor, the laser projector will automatically turn off the screen and have voice prompts to protect the user's eyes.
Standby Key	Turn the laser projector on or off.

Note

Please do not switch the laser projector on and off rapidly and continuously since it takes time to power off and process the system, or the machine may work abnormally. When entering the home page or using the menu, direction navigation may not be supported by some interfaces and applications.

If an abnormality occurs during the normally use, please try to power off the device and let it standby for 2 minutes, then power it on again.

Introduction of Ports

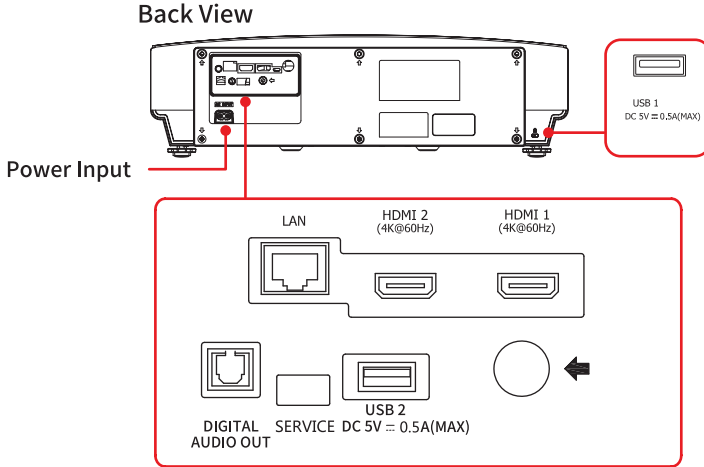

Note

Some external devices may not be able to connect with the laser projector due to individual differences. In such cases, please replace the appropriate signal line or add corresponding cable adapter that matches the port.

Debug port: For factory debugging only. Please do not insert any terminal.

Connection Instructions

Select Signal Input

Press the Signal Source button on the remote control to enter the signal source menu and select the signal source corresponding to the local port from the menu.

Connect Audio and Video Equipment

Connect with an HDMI cable



Local Port



Set-top box/Player/
Computer /DVD



HDMI Output

Note

Please see the technical parameters section for the signal format supported by the HDMI port.

Connect to the USB Port Device

The total current of all USB output ports of the machine shall not exceed 1400 mA when connected to external devices simultaneously. If the output current limit is exceeded and the machine fails, it is not covered by the warranty.

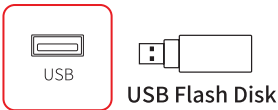

Local Port

Connect External Audio Equipment

Digital audio output: Through optical port to connect to audio power amplifier, and then through the power amplifier connected external speakers.

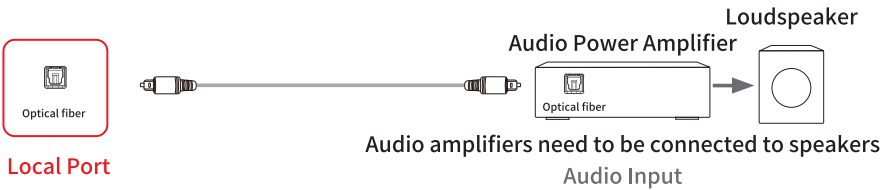

Local Port

Linked network

Press the settings button on the remote control to enter the Settings interface, select the network item, and press OK button to enter the network menu.

Wireless network connection

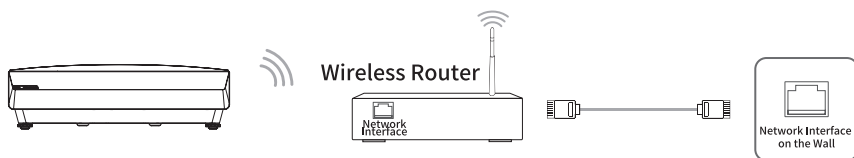

This machine can receive network signal directly through Wireless Router

1. Select the wireless network in the network menu and the list of available wireless networks will be displayed automatically.
2. Select an available network, enter your password, and click OK. (If the network you choose is not encrypted, you can connect directly.)
3. If the network you want to connect is not shown in the list, please select "add a new network" at the bottom of the list, enter the network name manually, select the corresponding encryption method according to the router settings, and then enter the password, and click Add.

Wired network connection

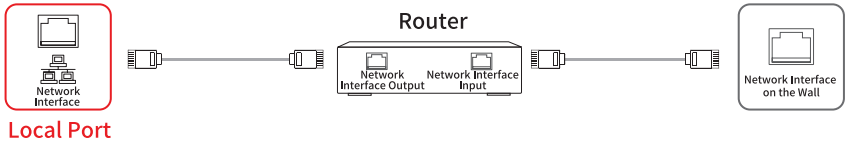

Automatically Obtain IP Address

1. After inserting the cable, the machine will automatically get the IP address and connect to the network.

2. If the connection fails, try again or try to connect manually.

Enter IP manually.

1. Select Network Information from the Network menu.

2. After selecting manually, enter the IP address, subnet mask, DNS server and gateway, and click Connect.

Environment	Working Requirements
Working Voltage	100-240V~, 50/60Hz
Working Temperature	5~35°C
Working Humidity	20-80%
Storage Temperature	-15~65°C
Power	185W
The Speaker Power	10W*2

Initial Startup

1. Power On/OFF

- Connect the machine power cords to the AC power socket.
- Press the Standby button on remote control to open the machine, and then complete the wizard Settings followed the prompt of the boot navigation (boot navigation information shall be subject to the actual ones).
- Press the Standby button on the remote control and the machine will enter the standby mode. To get back to the normal mode, just press the Standby button again. Please disconnect the power supply if the machine is not in use for extended periods.

Note

- After the DC power off, please at least wait for 5 seconds to start up again to prevent the abnormality of the machine.

2 Adjust Local Settings

By using settings function, you can meet your different needs, fully enjoy the audio-visual effects brought by the machine. From here you can adjust the image, the sound, set up the network connection and so on.

Press the Settings button on the remote control to enter the settings interface and adjust each settings item.

At each level of the menu, you can do the following according to different menus:

- Press the direction button to select items.

- Press OK to confirm or enter the sub-menu.

- Press Left or Right button to adjust the value

- Press Up or Down button to adjust options.

Press the Back button to return to the previous menu or to exit the Settings menu.

Others

1 Environmental Protection

This product meets the environmental protection requirements of the Administrative Measures for the Restricted Use of Harmful Substances in Electrical and electronic Products. During the period of environmental protection, there will be no leakage or precipitation of harmful substances in the process of use, which will affect the health of consumers, so it can be safely used.

Scrap Recycling Tips

When this product is not needed or its life is over, please comply with the national laws and regulations on recycling and disposal of waste electrical and electronic products, and give it to the local manufacturer with the qualification of recycling processing recognized by the state for recycling. The recycling manufacturer shall reasonably dispose of the parts containing harmful substances and shall not dispose of them at will.

Environmental Protection Use Period

The environmental protection life of this product is 10 years.

The battery life of the remote control used with the product shall be 1 year.

The Name and Content of Harmful Substances in the Product

Name of Parts	Hazardous Substances					
	Lead and its Compounds	Mercury and its compounds	Cadmium and its compounds	Hexavalent chromium compound	(PBB) polybrominated biphenyls	(PBDE) Polybrominated phenyl ether
Laser Light Source	×	○	○	○	○	○
Light Units	×	○	○	○	○	○
Circuit Card Assembly	×	○	○	○	○	○
Power Cord and Connection Cord	×	○	○	○	○	○
Non-flame Retardant Plastics and Polymer Components	○	○	○	○	○	○
Flame Retardant Plastics and Polymer Components	○	○	○	○	○	○
Metal Parts	×	○	○	○	○	○
Accessories (Remote Control/Battery, etc.)	×	○	○	○	○	○

This form is made according to the provisions of SJ/T 11364.

“○” means that the content of the hazardous substance in all homogeneous materials of the component is below the limit specified in GB/T 26572.

“×” indicates that the content of the hazardous substance in at least one homogeneous material of the component exceeds the limit specified in GB/T 26572.

The material identified in the table as “x” is currently technically irreplaceable. The use of these materials conforms to the requirements of the Management Measures for the Restricted Use of Hazardous Substances in Electrical and Electronic Products and the Exception List of Restricted Substances in the Management Catalog of Standards. We are committed to the research and use of new materials and new technologies. If it is technically feasible, we will gradually replace or phase out the use of this part of materials.

Simple Troubleshooting Methods

Before preparing for repair, please check the following table to see if you can find the causes of the failure you have encountered.

When you are convinced that you have followed this instruction and still cannot fix the problem, you may consider contacting a professional service provider for repair.

Phenomenon	Solutions
No sound or image	Check if the power cord is connected to the wall socket and if the wall socket is energized.
	Check if you have pressed the power button or standby button. Check the volume Settings or whether it is in silent mode.
	Check the volume Settings or whether it is in silent mode.
The picture is normal but there is no sound	Check the volume settings or mute.
No frames or images in black and white	Adjust the image Settings.
	Check the color scheme.
Sounds and images are disturbed	Close or unplug devices connected to the machine that are not currently in use.
Blurred or distorted picture	Observe whether the light mirror is dirty when the device is powered off, please ask professional personnel to use optical cleaning cloth or mirror wiping paper and professional cleaning solution to carefully wipe.
Horizontal/vertical stripes or image shakes	Check for nearby sources of interference, such as electrical appliances or power tools.
The machine case "clicks"	A change in room temperature sometimes causes the casing to expand or contract, which produces sound, and this is not due to a malfunction in the unit.

3 Attentions



The terms HDMI and HDMI High-Definition Multimedia Interface, and the HDMI Logo are trademarks or registered trademarks of HDMI Licensing Administrator, Inc. in the United States and other countries.



For DTS patents, see <http://patents.dts.com>. Manufactured under license from DTS Licensing Limited.

DTS, DTS-HD Master Audio, DTS-HD, Virtual:X, and the DTS-HD logo are registered trademarks or trademarks of DTS, Inc. in the United States and other countries. © 2021 DTS, Inc. ALL RIGHTS RESERVED.



Dolby, Dolby Atmos, and the double-D symbol are registered trademarks of Dolby Laboratories Licensing Corporation.

Manufactured under license from Dolby Laboratories. Confidential unpublished works. Copyright © 2012-2021 Dolby Laboratories. All rights reserved.

Note

The instructions and images shown in the manual are indicative only. If there is inconsistency between the image and the actual product, the actual product shall govern. (This statement runs through the entire manual)

Service and quality upgrades, product designs and specifications shall be subject to any changes without additional notices.

The content service of software applied to this product depends on the third-party provider. Some software may not be available due to network, region, service cycle and other issues. These problems have nothing to do with the quality of this product, please contact the third-party provider for relevant details.

Important Safety Precautions

	This symbol alerts user about the presence of a dangerous voltage not isolated inside the product which can be sufficiently powerful to constitute a risk of electrocution.		ATTENTION RISK OF SHOCK ELECTRIC	
	This symbol alerts user about the presence of important operating instructions and maintenance in the document enclosed in the package.	<p>Do not open the back cover.</p> <p>In no case the user is allowed to operate inside the TV set. Only a qualified technician is entitled to operate.</p>		



Class II product: This symbol indicates that it does not require a safety connection of protective earthing (ground).



AC voltage: This symbol indicates that the rated voltage marked with the symbol is AC voltage.

Disposal of Used Electrical & Electronic Equipment



Packaging and electrical goods should be recycled appropriately, and not treated as household waste. Please dispose of this equipment at your applicable collection point for the recycling of electrical & electronic equipment waste. By ensuring the correct disposal of this product, you will help prevent potentially hazardous to the environment and to human health, which could otherwise be caused by unsuitable waste handling of this product. The recycling of materials will help conserve natural resources. Please do not therefore dispose of your old electrical and electronic equipment with your household waste. For more detailed information about recycling of this product, please contact your local city office, your household waste disposal service or the shop where you purchased the product.

Wireless LAN Module specifications	Frequency Range	2.4~2.4835GHz 5.15~5.85GHz
	Output Power (Max)	2.4~2.4835GHz 16dBm 5.15~5.25GHz 14dBm 5.25~5.35GHz(DFS Band) 14dBm 5.49~5.71GHz(DFS/TPC Band) 14dBm 5.725~5.85GHz(for Non EU) 14dBm
Bluetooth Module specifications	Frequency Range	2.4~2.4835GHz
	Output Power (Max)	2.4~2.4835GHz,Class1,6dBm

Technical Specifications

The supported video formats are as follows:

Packaging	Video Coding				Audio Decoding
	Type	Resolution (Max)	Bit Rate (Max)	Frame Rate (Max)	
.avi	Xvid	1920 X 1080	40Mbps	60fps	Dolby Audio, MPEG1(Layer1,2,3)
.avi .mpg .ts	MPEG2	1920 X 1080	80Mbps	60fps	Dolby Audio, MPEG1(Layer1,2,3)
.ts .mkv .avi .mp4 .flv	H.264	4096 X 2160	135Mbps	60fps	Dolby Audio,AAC MPEG1(Layer1,2,3)
.avi .mkv .mov	MPEG4	1920 X 1080	40Mbps	60fps	Dolby Audio, MPEG1(Layer1,2,3)
.ts .mkv .mp4	H.265	4096 X 2160	100Mbps	60fps	Dolby Audio,AAC MPEG1(Layer1,2,3)

Dolby Audio: Dolby Digital, Dolby Digital Plus, Dolby TrueHD, AC4 supported.

Note

Due to the inconsistency of video production tools, this machine does not guarantee support for all formats listed

Signal formats supported by HDMI ports	
RGB/60Hz	640 X 480/800 X 600/1024 X 768
YUV/50Hz	576i/576p/720p/1080i/1080p
YUV/60Hz	480i/480p/720p/1080i/1080p
YUV/24Hz 25Hz 30Hz	3840 X 2160/4096 X 2160
YUV/420/50Hz 60Hz	3840 X 2160/4096 X 2160
YUV/444/50Hz 60Hz	3840 X 2160/4096 X 2160
RGB/444/50Hz 60Hz	3840 X 2160/4096 X 2160

Projector Distance & Size

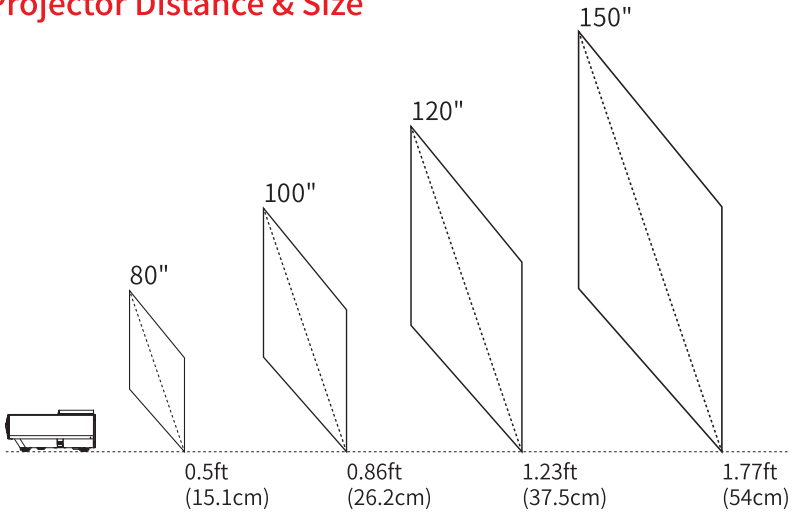

The recommended projection screen is around 100 inches with a projection distance of around 0.86 ft. Ambient darkness will improve the clarity of the projected images.

Color adjustment

The saturation of the image color can be changed through color adjustment, and it has two color changes: RGB and CMYK.

Path on Remote Control: Setting-->Image-->Advanced settings --> Color correction--> (Red, Green, Blue, Cyan, Magenta, Yellow, Skin correct)

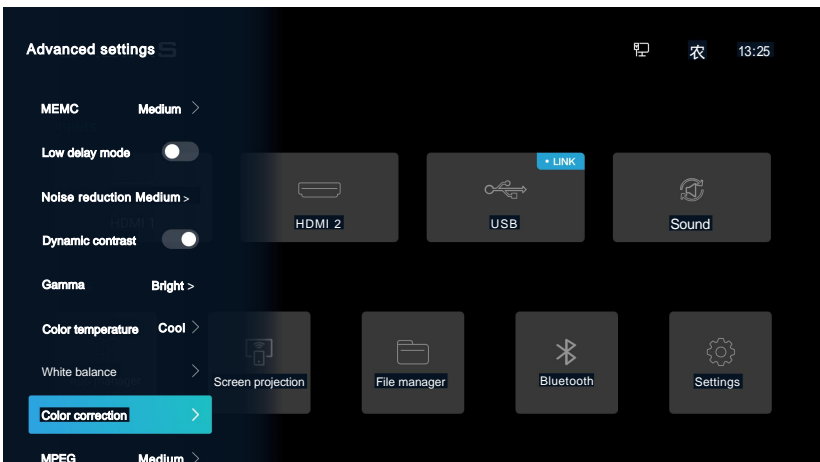

Audio output

In addition to built-in speakers, laser TVs can also be connected to external speakers via HDMI cable or Bluetooth pairing. When connecting different modes, you need to select the corresponding connection mode on the setting interface.

Path: Remote Control Setting--> **Sound** -> **Output device** --> (Optical, TV speakers , HDMI , Bluetooth)

Note: When the external speaker does not select the corresponding mode, the microphone sound cannot be returned.

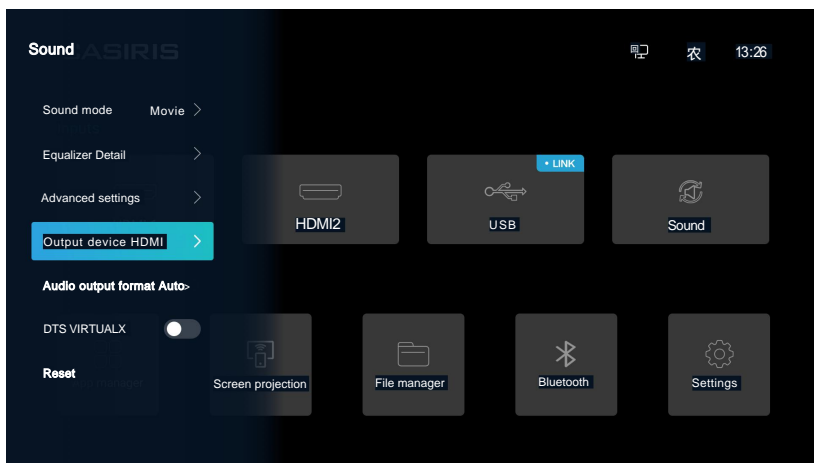

Audio output format

Only selectable when Audio output is Optical or HDMI mode, there are **Auto** and PCM modes.

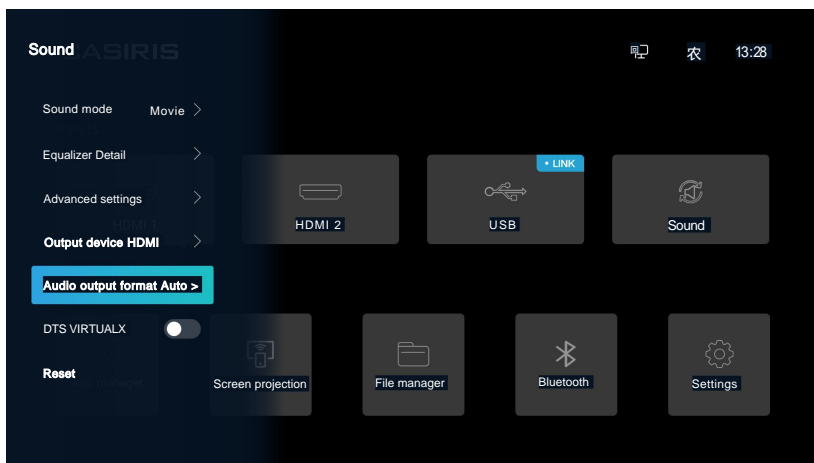

Bluetooth:

Bluetooth connection to speaker/mobile phone:

Step1: Open the setting interface through the remote control Setting button.

Step2: Find " Bluetooth ", open **Management**

Step3: Select **Other device** and press the ok button on the remote to search for Bluetooth, and the required Bluetooth appears, select Bluetooth to start pairing. Bluetooth-enabled devices such as external speakers or mobile phones can be connected via Bluetooth.

Path: Remote Control Setting --> Bluetooth --> **Management** --> **Other device** -->

Select connection and pairing

