

User's Manual

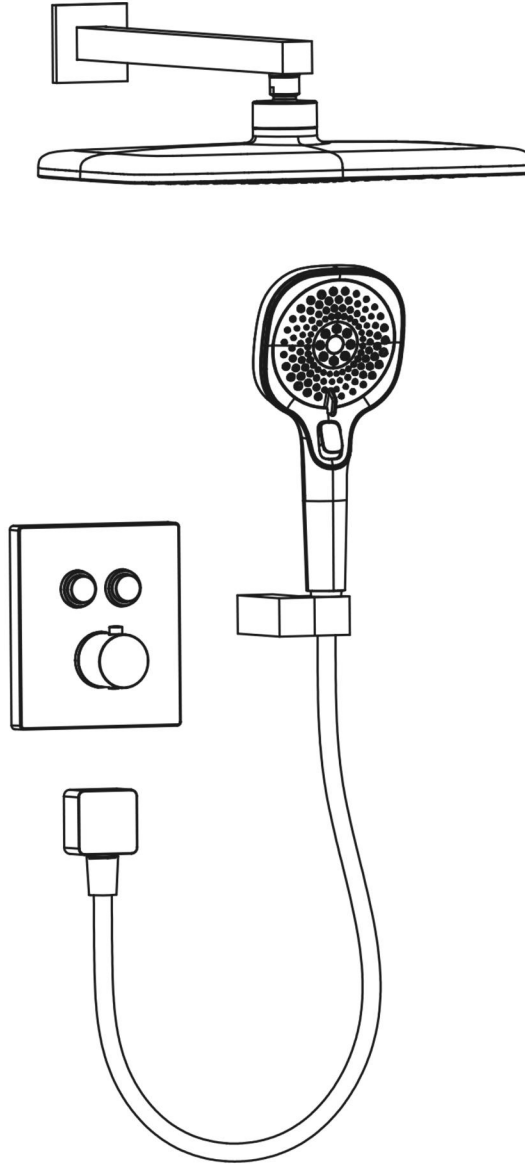

INSTALLATION INSTRUCTIONS

Installation Manual



IAPMO RESEARCH AND TESTING, INC.
5001 East Philadelphia Street, Ontario, California 91761-2816 • USA • 909-472-4100 • 909-472-4244 • www.iapmort.org

CERTIFICATE OF LISTING

 This certificate is not evidence of current listing. To verify listing status, visit the IAPMO R&T Product Listing Directory at pld.iapmo.org

Effective Date: December 2019 -Rev. 2/24/2020- Void After: December 2024
Product: Flexible Water Connectors File No. 5111
Issued To: Fanaki Group Inc.
Mechanical & Electrical
Industrial Zone,
Yuhuan County,
Yuhuan 317400, ZHEJIANG
China

Identification: Products shall be marked with manufacturer's name or trademark, a statement "For use with water in accessible locations only." The product shall also bear the cUPC® certification mark. Markings shall be by means of either a permanent mark on the product, a label on the product or a tag attached to the product.

Characteristics: Flexible water connectors manufactured in various sizes, lengths and metal and fittings for hot or cold water applications that consist of an inner tube, which may or may not have an outer braided cover. Connectors are to be installed for use in accessible locations only. To be installed in accordance with the manufacturer's instruction, and the latest edition of the Uniform Plumbing Code and National Plumbing Code of Canada.

Products listed on this certificate have been tested by an IAPMO R&T recognized laboratory. This recognition has been granted based upon the

 
Chairman, Product Certification Committee CEO, The IAPMO Group



This listing is based upon the test data on the test report on the Effective Date and Void After Date shown above. Any change in material, manufacturing process, marking or design without testing first obtained the approval of the Product Certification Committee, or any extension of the listing, shall require the approval of the Product Certification Committee. This listing is subject to the conditions set forth in the applicable rules and standards of the Uniform Plumbing Code or National Plumbing Code of Canada. Production of or reference to this form for advertising purposes may be made only by specific, written permission of IAPMO Research and Testing, Inc. Any alteration of this certificate could be grounds for revocation of the listing. This document shall be reproduced in its entirety.

IAPMO RESEARCH AND TESTING, INC.
5001 East Philadelphia Street, Ontario, California 91761-2816 • USA • 909-472-4100 • 909-472-4244 • www.iapmort.org

CERTIFICATE OF LISTING

 This certificate is not evidence of current listing. To verify listing status, visit the IAPMO R&T Product Listing Directory at pld.iapmo.org

Effective Date: November 2019 Void After: November 2024
Product: Plumbing Fixture Fittings File No. 10613
Issued To: Aqua Gallery Co., Ltd
11th-13th A10 Block
International Dynamics
Sanitary City, 528000
Foshan,
China

Identification: Plumbing supply fittings complying with this Standard shall be marked with the manufacturer's recognized name, trademark, or other mark or, in the case of private labeling, the name, trademark or other mark of the customer for whom the fitting was manufactured. The marking shall be accomplished by use of a permanent mark or by placing a permanent label on the product. Markings on plumbing supply fittings shall be visible after installation.

Single-handle, single-control, and automatic compensating mixing bath and shower valves shall have identifiable temperature control settings in which the settings are indicated by words ("cold", "warm", "hot", etc.), by numbers, or graphically.

Packages shall be marked with the manufacturer's name, trademark, or other mark as well as the model number or, in the case of private

 
Chairman, Product Certification Committee CEO, The IAPMO Group



This listing is based upon the test data on the test report on the Effective Date and Void After Date shown above. Any change in material, manufacturing process, marking or design without testing first obtained the approval of the Product Certification Committee, or any extension of the listing, shall require the approval of the Product Certification Committee. This listing is subject to the conditions set forth in the applicable rules and standards of the Uniform Plumbing Code or National Plumbing Code of Canada. Production of or reference to this form for advertising purposes may be made only by specific, written permission of IAPMO Research and Testing, Inc. Any alteration of this certificate could be grounds for revocation of the listing. This document shall be reproduced in its entirety.

IAPMO RESEARCH AND TESTING, INC.
5001 East Philadelphia Street, Ontario, California 91761-2816 • USA • 909-472-4100 • 909-472-4244 • www.iapmort.org

CERTIFICATE OF LISTING

 This certificate is not evidence of current listing. To verify listing status, visit the IAPMO R&T Product Listing Directory at pld.iapmo.org

Effective Date: March 2019 Void After: March 2024
Product: Plumbing Fixture Fittings - Components File No. MC-9703
Issued To: Ningbo Nandai Cartridge Technology Co., Ltd.
Linchou Zone, Chunhui
Fengpu, JIANGSU 215518
China

Identification: Each fitting component shall bear permanent legible markings to identify the manufacturer. This marking shall be the trade name, trademark, or other mark known to identify the manufacturer. The product shall also bear all other markings required by the standards. The marking shall be applied so as to be visible after installation. The product or packaging shall also bear the cUPC® certification mark along with the term "COMPONENT" above.

Characteristics: Plumbing fixture fitting components to be installed in accordance with the manufacturer's instructions and the requirements of the latest edition of the Uniform Plumbing Code.

Products listed on this certificate have been tested by an IAPMO R&T recognized laboratory. This recognition has been granted based upon the Laboratory's compliance to the applicable requirements of ISO/IEC 17025.

Products are in compliance with the following code(s):
Uniform Plumbing Code (UPC®)

 
Chairman, Product Certification Committee CEO, The IAPMO Group







This listing is based upon the test data on the test report on the Effective Date and Void After Date shown above. Any change in material, manufacturing process, marking or design without testing first obtained the approval of the Product Certification Committee, or any extension of the listing, shall require the approval of the Product Certification Committee. This listing is subject to the conditions set forth in the applicable rules and standards of the Uniform Plumbing Code or National Plumbing Code of Canada. Production of or reference to this form for advertising purposes may be made only by specific, written permission of IAPMO Research and Testing, Inc. Any alteration of this certificate could be grounds for revocation of the listing. This document shall be reproduced in its entirety.

BEFORE INSTALLATION

► Installation Environment

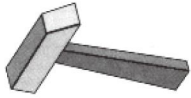
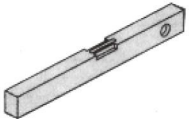
1. Before installation, confirm whether the inlet pipe and angle valve are correct. Make sure that the installation is completed, and the water has been flushed to ensure that there are no impurities in the water inlet pipe;
2. Water inlet pressure requirements: $5\text{bar} \geq \text{inlet pressure} \geq 0.5\text{bar}$, it is recommended to install a pressure reducing valve if it is greater than 0.05MPa ;
3. When installing and using the faucet, please use normal torque to prevent the handle from breaking.
4. If the customer goes out for a long time or does not use the faucet for a long time, please close the faucet valve and turn on the faucet switch to release the pressure and water in the faucet.

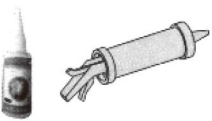
► Installation Aids

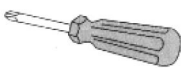
		
Hammer	Spirit level	Adjustable wrench
		
Glue (do not use glue containing acetic acid)	Impact drill	Screwdriver

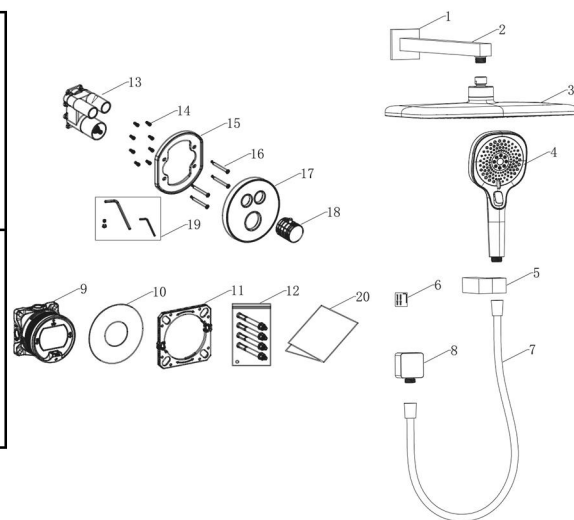

► Parts List

NO.	Item	Qty	NO.	Item	Qty	NO.	Item	Qty
1	Decorative cups	1	8	Wall Mount	1	15	Panel Connection Plate	1
2	Overhead Spray Hose	1	9	Concealed manifolds	1	16	M5 screws	4
3	Overhead Shower	1	10	Fabric pads	1	17	Decorative panels	1
4	Hand Shower	1	11	Cavity wall mounting Plate	1	18	Thermostatic Handwheel	1
5	Shower Sockets	1	12	Expansion screws	4	19	Accessory Kits	1
6	Accessory Kits	1	13	Control valve set	1	20	Instruction manual	1
7	Hose	1	14	M5 hexagon socket countersunk head screws	8			

Check accessories

Standard List of Accessories:

When you open the product packaging, please check whether the objects in it are consistent with the main body and accessories you purchased. If there is any inconsistency, please contact our company or our distributor.

Note: 1. Accessories are subject to change without prior notice if the change does not affect usage;

2. The appearance of the product is subject to the physical objects you receive, and the schematic diagram is only for reference.

INSTALLATION STEPS

This product has been inspected and debugged by the factory to the best condition. Please do not disassemble and assemble it yourself.

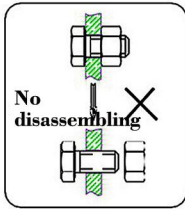

Before installing the faucet, please be sure to remove sundries and sludge from the water pipe to prevent sundries from blocking the faucet.

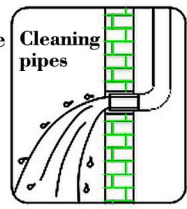

01 SOLID WALL INSTALLATION

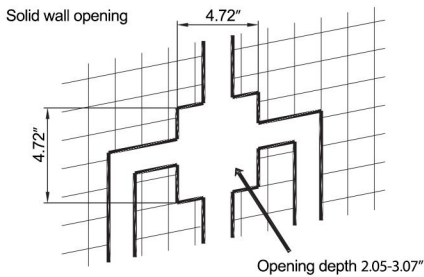

INSTALLATION OF PRE-BUILT BOXES

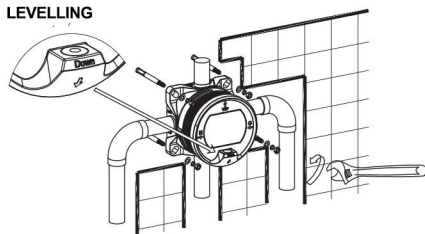
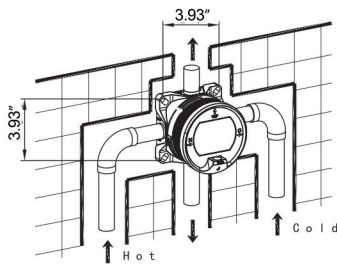

Observe the level to ensure a level installation

02 SEALING TEST

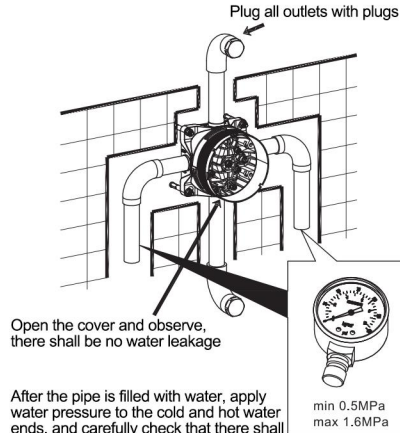

SEALING THE WALL

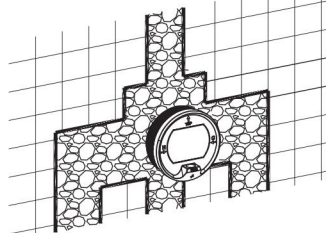

After the sealing test, seal the pre-built openings and pipes with cement packing.

HOLLOW WALL INSTALLATION

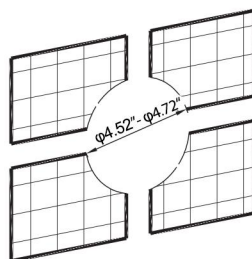

03

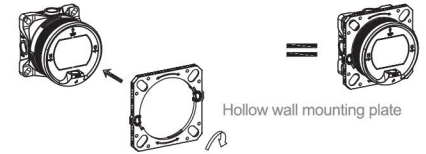

Screw the hollow wall mounting plate into the pre-embedded box

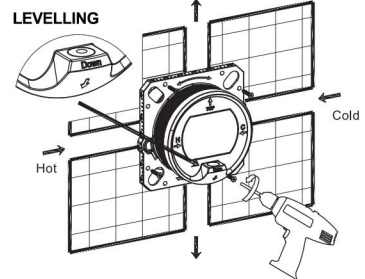

Observe the level to ensure a level installation

SEALING TEST

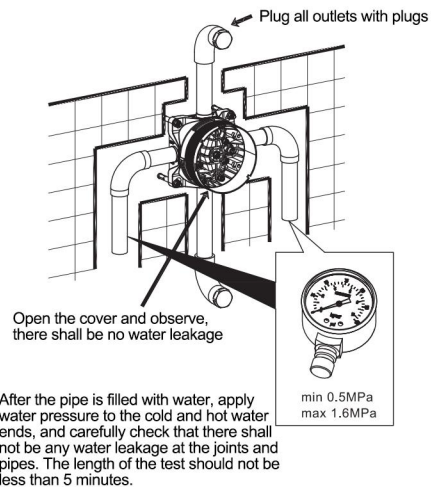

04 PASTE THE WALL TILES

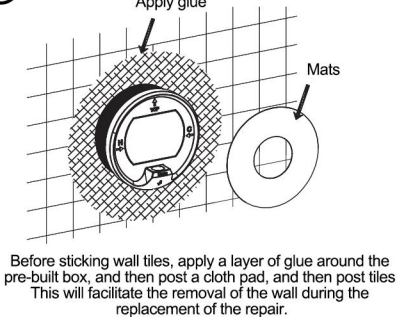

Before sticking wall tiles, apply a layer of glue around the pre-built box, and then post a cloth pad, and then post tiles. This will facilitate the removal of the wall during the replacement of the repair.

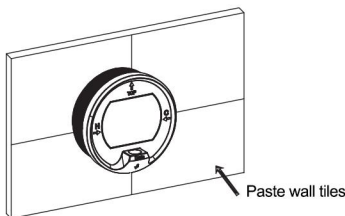

05 CONTROL VALVE INSTALLATION

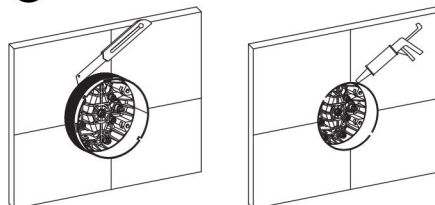

Remove the pre-embedded box above the wall surface.

Put sealant around the pre-embedded box to enhance the sealing between the box and the wall.

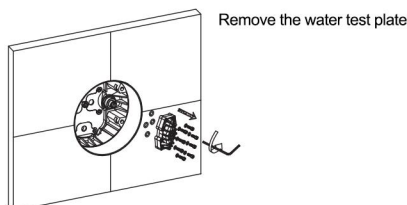

Remove the water test plate

06



The control valve is fitted with a sealing ring.

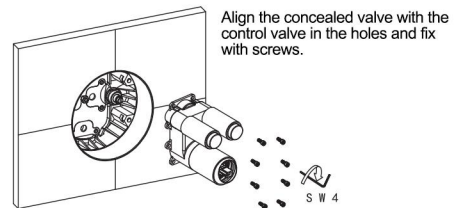

Align the concealed valve with the control valve in the holes and fix with screws.

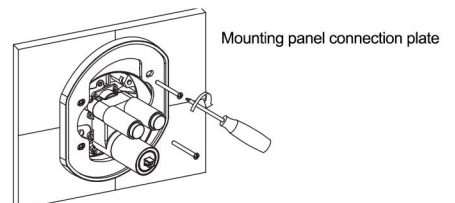

Mounting panel connection plate

INSTALLATION STEPS

This product has been inspected and debugged by the factory to the best condition. Please do not disassemble and assemble it yourself.



Before installing the faucet, please be sure to remove sundries and sludge from the water pipe to prevent sundries from blocking the faucet.

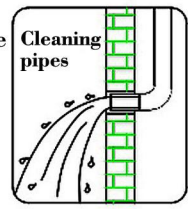

INSTALLING THE PANEL

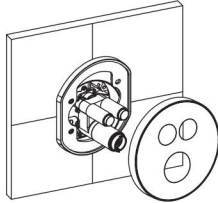

Lightly press the panel into the panel attachment plate with the bottom of the panel level with the wall.

INSTALL THE THERMOSTAT HANDLE

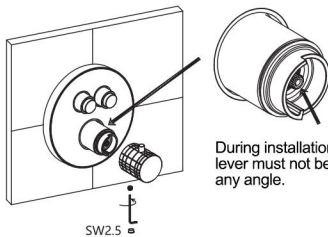

During installation, the gear lever must not be turned at any angle.

SW2.5

INSTALLATION OF THERMOSTATIC HANDLES

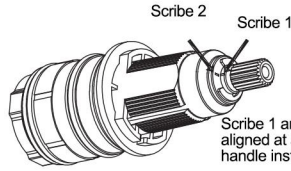

Scribe 1 and Scribe 2 should be aligned at all times during handle installation.

Install the handle. During the installation of the handle, the spool's spline must not be turned at any angle to ensure that the default temperature after installation of the handle is 38°C. If the spline is inadvertently turned at an angle during the process, the default temperature position must be adjusted according to the spool's limiting scales (locating the painted line).

FAUCET USE METHOD

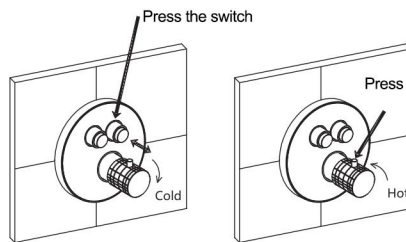

Press the switch

Press

Hot

Cold

INSTALLATION OF NOZZLE

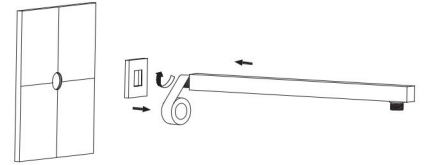

Put the decorative cup into the top spray pipe, wrap the raw material tape around the outer teeth of the top spray pipe inlet, screw the top spray pipe clockwise into the water outlet position on the wall.

INSTALLATION OF THE TOP SPRAY PIPE



Use a tool to make a hole in the wall according to the position of the shower seat fixing ring, place the adhesive pellet in the hole in the wall and lock the fixing ring in the wall.

Adjust the position of the floral wine socket, slip it into the retaining ring and tighten the screws with a hexagonal spanner to lock the shower socket.

WALL MOUNT INSTALLATION

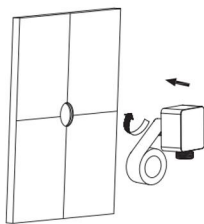

Wrap the raw material tape around the outer teeth of the water inlet of the wall mount, and screw the wall mount clockwise into the water outlet position on the wall.

TOP SPRAY SHOWER, HAND SHOWER, HOSE INSTALLATION

Ensure that the overhead shower and hose contain rubber flat washers. Screw the hand shower and overhead shower clockwise into the threads as shown.

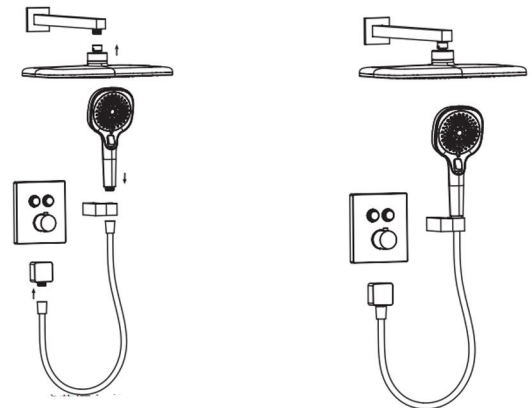

1. Wrap water inlet joint with the raw material tape and connect it with the water pipe embedded in the wall.
2. Attach the decorative cover to water inlet joint on the wall.
3. Measure the mounting position of the fixing seat according to the actual size of the product. After making the mark, drill a hole on the wall and punch the self-tapping rubber particles into the hole, then use the self-tapping screw to fix the fixing seat on the wall, and then set it firmly on the decorative cover.
4. Insert the water knockout drum into the top shower pipe, adjust the position it with a pole into the fixing seat on the wall, adjust the position and tighten it with a hexagonal wrench. If the position is slightly misaligned when the product is installed, the eccentric joint and fixing seat can be adjusted appropriately. and tighten it with a hexagonal wrench, and then connect it with the water inlet connector, tighten it with a hexagonal wrench, then insert the fixing seat on water knockout drum to the fixing seat on the wall, adjust the position and tighten.

INSTALLATION STEPS

► Test method

1. Turn the faucet handle to the closed position, open the water inlet valve, and check whether there is any leakage at all water inlet ports.
2. Open the faucet handle to the maximum, and open the water inlet valve to check whether there is leakage at the water outlet and the sprinkler connection port.
3. Operate the reversing valve several times to check the shower water condition and whether there is any leakage outside the connection.
4. If the water pressure is lower than 0.05M Pa (it is possible that the faucet drips while the shower sprinkles water, or the faucet reversing valve does not work), a booster pump should be installed in the pipeline.

INSTALLATION DIMENSION

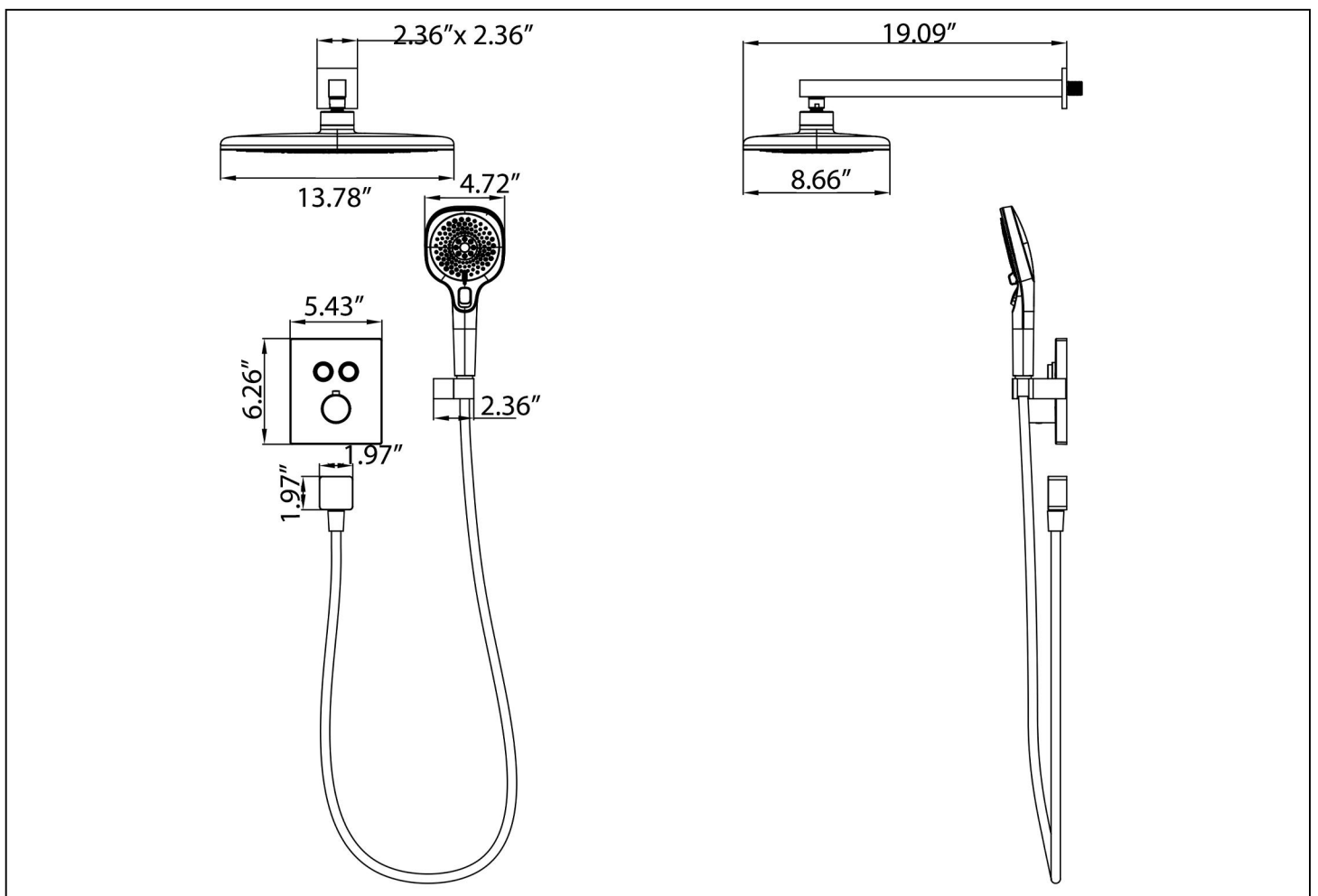

CLEANING CARE

In order to keep the appearance of faucet clean, bright and good performance, please take care of the faucet as follows;

1. Rinse with water only and dry with soft cotton cloth;
2. Use mild liquid and colorless glass cleaner to remove surface dirt and scale film, or use polish without abrasive effect;
3. Do not use abrasive detergent, polish, emery cloth, paper towel or scraper, etc.;
4. Do not use acid cleaner, or cleaner and soap with insoluble gran etc.;
5. In the process of use, mud may accumulate in the bubbler and make the water flow show, The bubbler can be unscrewed, rinsed with water, and then installed back in place.



Please feel free to contact us if you have any questions. We will help to solve the issue together with you.

