

ASSEMBLY INSTRUCTIONS

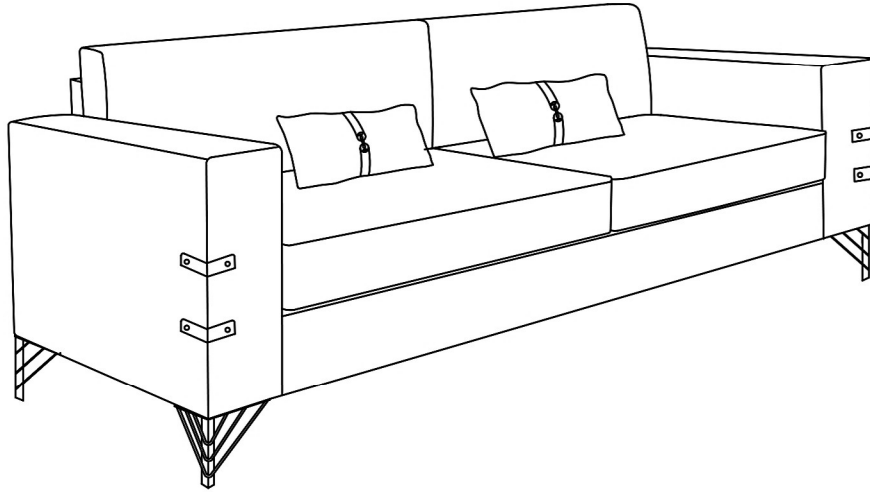







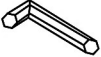

ITEM NO:P14-3S

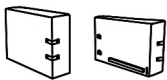

*Please do not move the sofa after installation. If you need to move the sofa, please disassemble the sofa first, and re-install it at your destination.

*Please keep this *installation instruction for your future use.

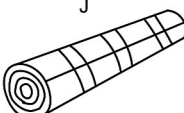
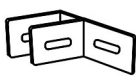
*Please read steps 3, 4, 5 and 6 of the assembly installation carefully

- | | | | |
|---|---|--|---|
| A

Spanner
1PCS | B

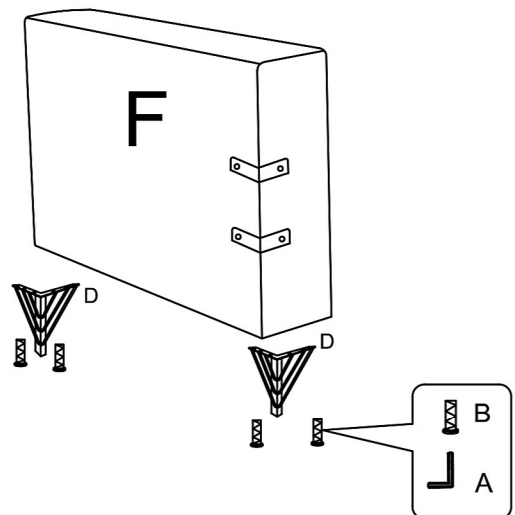
Bolt
10PCS | C

Middle leg
1PCS | D

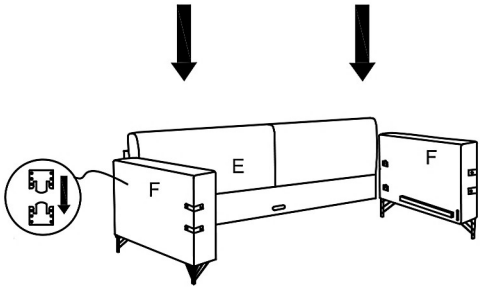
Legs
4PCS |
| E

Sofa Back
1PCS | F

Arm
2PCS | G

Center Bar
1PCS | |
| H

Seat Board
1PCS | I

Front Board
1PCS | J

Compressed seat cushion
2PCS | |
| K

Connect hardware
2PCS | L

Seat cushion cover
2PCS | M

Lumbar pillow
2PCS | |

STEP 1



STEP 2



STEP 3 *

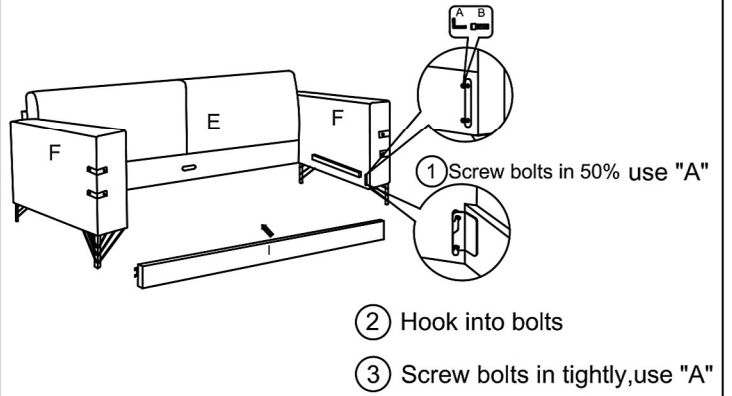

STEP 4 *

Screw bolts in tightly

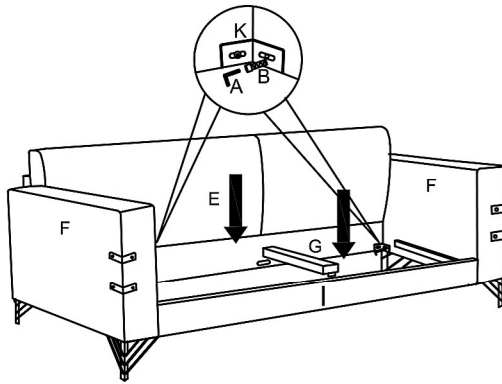

STEP 5 *

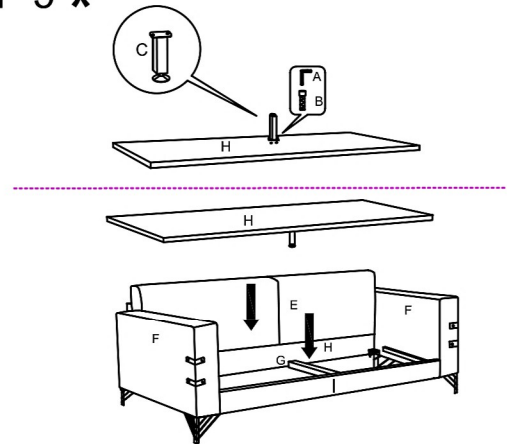

STEP 6 *

Compression use of Seat cushion.

How to tidy sofa seat cushions ?

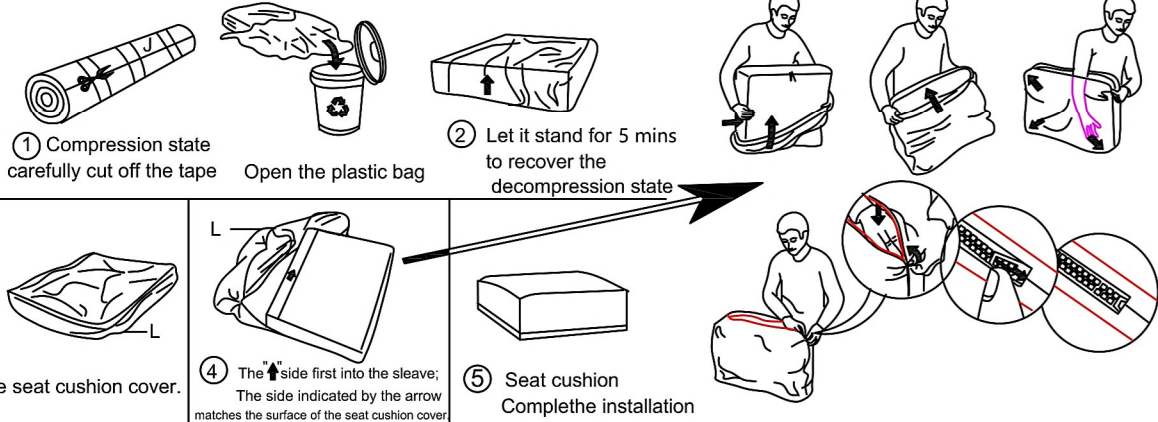

STEP 7

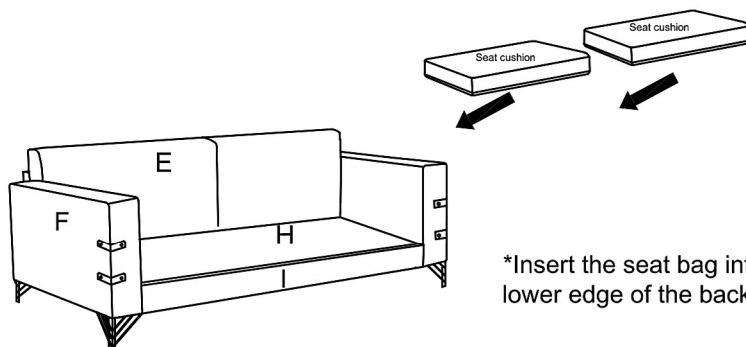

STEP 8

