

Thank you for purchasing our product. Please carefully read  
and strictly follow the product manual before use.  
Please keep it properly after reading for future reference.



## Optical Fiber Fusion Splicer Instruction Manual

The content of this article is suitable for the employees,  
agents and customers to read when they are using the relevant products.  
No group or individual can copy or reprint this document without written permission.

# CONTENTS

<b>1</b>	<b>Summary</b>	<b>01</b>
<b>2</b>	<b>Technical Specifications</b>	<b>02</b>
<b>3</b>	<b>Installation</b>	<b>03</b>
	3.1. security warning	
	3.2. battery precautions	
	3.3. maintenance and appearance protection	04
	3.4. transportation and storage	
<b>4</b>	<b>Basic Operation</b>	<b>05</b>
	4.1. appearance overview	
	4.2. battery charging	06
	4.3. power on	
	4.4. adjust the brightness of LCD backlight	07
	4.5. preparation steps for fiber	
	4.6. automatic inspection of optical fiber	
	4.7. splicing procedures	08
	4.8. magnification function of screen	09
<b>5</b>	<b>Splicing Mode</b>	<b>10</b>
	5.1. display of the current splicing mode	
	5.2. selection for splicing mode	
	5.3. parameters in general splicing procedures	11
<b>6</b>	<b>Splicing Options</b>	<b>12</b>

<b>7</b>	<b>Heating Mode</b>	<b>13</b>
	7.1 selection for heating mode	
	7.2 edit of the heating mode	14
	7.3 delete of the heating mode	
<b>8</b>	<b>System Maintenance</b>	<b>15</b>
	8.1 dust checking	
	8.2 motor calibration	
	8.3 electrode stabilize	
	8.4 arc calibration	
	8.5 electrode setting	16
<b>9</b>	<b>Other Functions And Applications</b>	<b>17</b>
	9.1. records storage	
	9.2. system settings	
	9.3. system info	
<b>10</b>	<b>Excessive Splicing Loss And Solutions</b>	<b>18</b>
<b>11</b>	<b>Common Error Warnings And Solutions</b>	<b>19</b>
<b>12</b>	<b>Common Malfunctions And Solutions</b>	<b>20</b>
	<b>Attachment: Quick User Guide</b>	<b>21</b>

## 01. Summary

Thanks for choosing our product. This manual mainly introduces the function, instructions, maintenance as well as precautions to help you get familiar with the operations.

By adopting innovative design and exquisite manufacturing technology, this splicer will give you unprecedented splicing experience. The brand new technology greatly shortens the time for splicing and heating: Micron-level parallel clamping, high precision alignment of the spindle, and the advanced contour inspection technology ensure the accuracy of estimation for splicing loss; light body, exquisite design with strong solid protective shell can make itself work in harsh environment; Touch screen application with fully automatic splicing procedures will bring great convenience to users.



Attention: it is recommended that all users read this manual before usage.

## 02. Technical Specifications

Specification	Category
Applicable Fibers	SM(ITU-T G. 652&G. 657).MM(ITU-T G. 651). DS(ITU-T G. 653),NZDS(ITU-T G. 655)
Compatible Fiber/Cable	0.25-3.0mm/ Indoor Cable
Cladding Diameter	80-150μm
Cleaved Length	Coating Diameter: 0.125-1mm/Cleave length:8-16mm
Splicing Mode	Preset 41 splicing modes, storable 100 modes
Typical Splice Loss	SM: 0.02dB/MM: 0.01dB/DS: 0.04dB/NZDS: 0.05dB/G657:0.03dB(ITU-T Standard)
Return Loss	≥ 60 dB
Lighting	2 powerful white LEDs
Splicing Time	SM FAST mode: 5s
Estimated Splice Loss	Yes
Protection Sleeve Length	20-60mm
Heating Tank	Preset 5 kinds of thermal heating tube: 20/30/40/50/60mm, Max 100 modes
Heating Time	11s
Results Storage	20000 latest records & 200 images
Tension Test	Standard 2.0N
Display	4.3" high resolution display with touch screen
Fiber View & Magnification	X,Y,XY,X/Y: 380X Magnification
Fiber Holder	Multi-function free disassembly fiber clamp
Power Supply	AC Input 100-240V, DC Input 12-15V
Battery Capacity	7200mAh battery capacity
Heating Times	Typical above 320 times(splicing+heating)
Operating Methods	Button/Touch Screen
Automatic Calibration	Automatic ARC calibration by air pressure and temperature
Electrode Life	5000 ARCS
Terminal	USB 2.0
Weight	1.75KG(including rubber bumper)
Dimension	135.1W*205.9L*130.4mm(W*L*H)
Operating Condition	Operating altitude: 0-5000m above sea level, 0-95% relative humidity -15~50°C, max wind 15m/s
Storage Condition	0~95% relative humidity, -40~80°C; battery storage: -20~30°C
VFL	Visual Fault Locator: Power:15mw,2HZ Flashing And Constantly Bright Mode
Power Meter	Wavelength: 850nm、 1300nm、 1310nm、 1490nm、 1550nm、 1625nm
	Measuring Range:-50+26dbm Absolute Error:<0.3db(-50dbm ~ +3dbm Range)

## 03. Installation

### 3.1 Security warning

Fiber Fusion Splicer is designed for splicing of silica glass fiber which can not be used for any other purposes. It's a precision instrument which should be handled with great care, and obey the following safety rules and regulations:

- Do not use the fusion splicer in explosion hazard, don't expose it to the open flame, electric shock, raining or wet environment;
- Do not touch the electrode bar at any time when power is on.
- Wear protective glasses when prepare the fiber, or it will cause bad influences to your eyes, skin.
- Please do not disassemble any parts of the splicer except the allowed users. Replacement and internal adjustment could only be operated by manufacturer or the authorized maintenance personnel.
- Please take the battery when anything below happen: - Abnormal smoke, smell, sound or heating.
  - Liquid, foreign matter getting into internal of the fusion splicer.
  - Machine being damaged or broken.

If any above problems happen, please contact the service center immediately. Failure to take measures in time would result in the machines totally broken, or even cause a fire, human injury or death.

- Only standard battery from manufacturer is allowed to use. Improper use of AC power may result in fire, electric shock and equipment damage, and may even cause fire, human injury or death.
- Only standard adapter from manufacturer is allowed to use. Do not put heavy objects on the battery line, do not heat or change the cable. Improper or broken cable will result in fire, electric shock and equipment damage, and may even cause fire, human injury or death.
- To avoid fire or danger, please do not stack the battery together with the adapter when charging.

**Attention: Only professional electrode bars can be used. If replace electrode, Please select option in the system maintenance or turn off the power in advance, The discharge operation is not permitted before the paired electrode bars are mounted.**

### 3.2 Battery precautions

- Its recommended the battery pack be stored separately from the machine when the fusion splicer is not used for over 1 month.
- Battery can not be transported or stored with other metal objects.
- Do not charge or discharge for long time in low temperature or high temperature, so as not to reduce the life of the battery or accident.
- Prohibit using metal objects such as wire to connect the positive and negative end of the battery.
- Prohibit shortcut of the positive or negative of the battery with the aluminum plastic packaging layer of the core.
- Do not disassemble the battery personally or into fire, so as to avoid an explosion.
- Batteries belong to consumables and have a certain lifetime. When checking the battery pack power, if all indicator lights are on, but splicing times are few, please change the battery.
- After completion of battery pack charging by adapter, disconnect the power timely, long time of full power charging will harm the battery itself or cause accident.
- Do not heat or throw the battery into water.
- Charging besides fire or hot environment is forbidden.

- Putting the battery into microwave or high is pressure container.
- Long-term usage or placement under high temperature environment, like strong sunshine or hot car, is forbidden, otherwise, the battery will overheat, fire, or function recess, battery life will be reduced.
- Using of the broken batteries is forbidden. Batteries that leak electrolyte or smell of electrolyte should be kept away from fire to avoid battery fire or explosion; if the electrolyte leaks and come into contact with the skin or other parts of the body, it should be washed with water immediately. If the electrolyte is in contact with the eyes, it should be washed immediately with water and then hospitalized nearby.

### 3.3 Maintenance and appearance protection

- Check and clean the V-groove timely, avoid touching the V-groove and electrode bar with hard object.
- Use a dry cloth to remove dust and dirt from the splicer.
- If the Splicer is dirty, avoid using acetone and thinner of paint to clean any parts of the splicer, dehumidified soft cloth immersed by neutral cleaning liquid can be used instead. Use dry cloth to clean the splicer, do not use furniture polish or other cleaner.

### 3.4 Transportation and storage

- Do not store the splicer in dusty or wet environment. Otherwise it will cause electric shock, and the performance of the splicer will be reduced or even damaged.
- Keep the minimum humidity while preservation, and the relative humidity should be less than 95%.
- When the splicer is moved to a warm environment from a cold environment, try a gradual warming-up method, otherwise condensation will income inside the machine which will influence the splicer.
- Try to avoid strong impact and vibration after the splicer being precisely adjusted and calibrated. Please use special-made carrying case for long distance transportation.
- Avoid direct sunlight or in overheat environment.
- To ensure performance, it is recommended to carry out a whole maintenance once a year.
- Splicer must be repaired and adjusted by technicians. Please contact manufacturer if there is problem.

## 04. Basic Operation

### 4.1 Appearance overview



### 4.2 Battery charging

The battery installation is shown below:

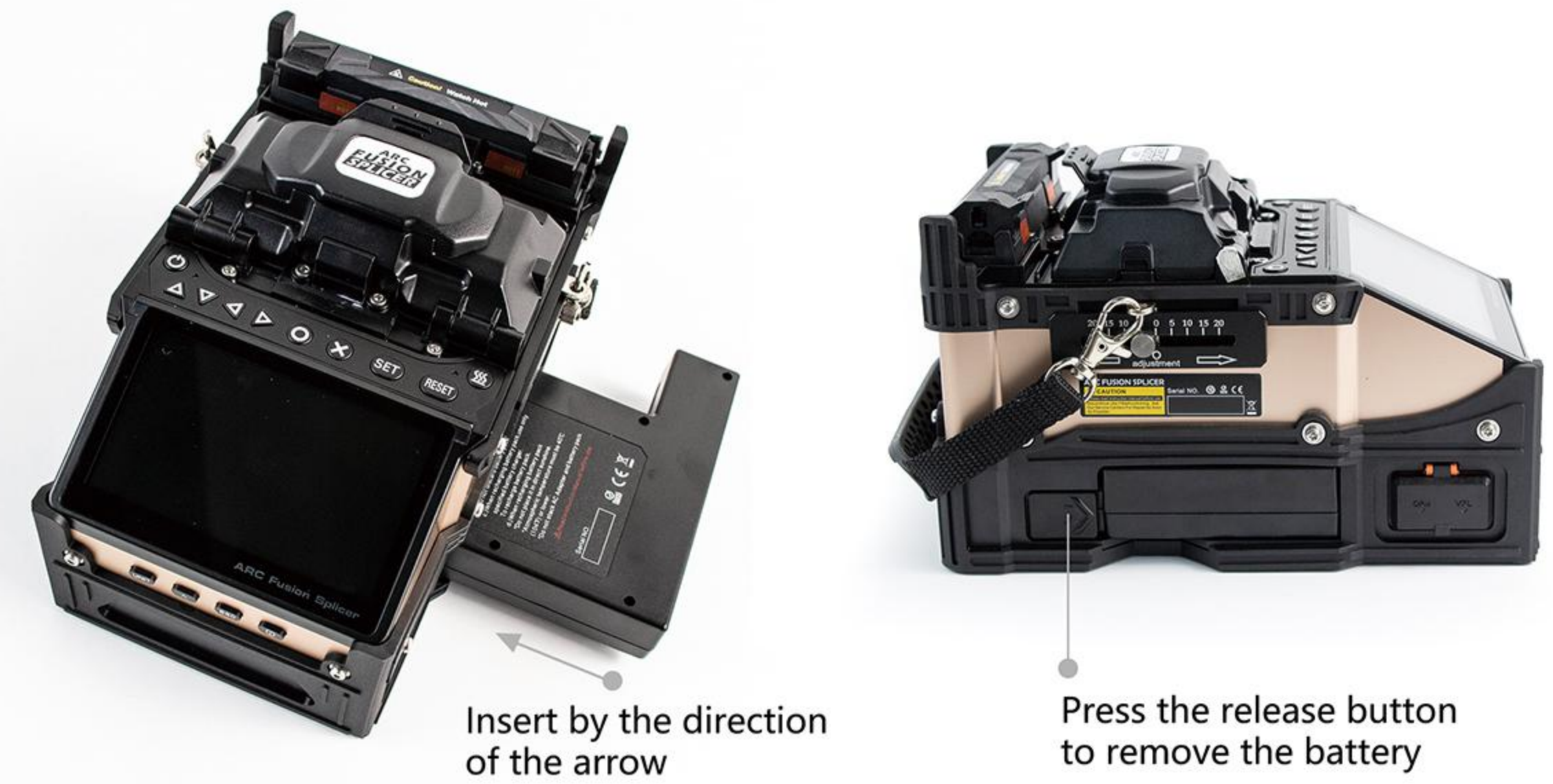

Charge the battery



### 4.3 Power on

Press the power button of the operation panel of the fusion splicer and wait for it to start and enter into the display work screen.

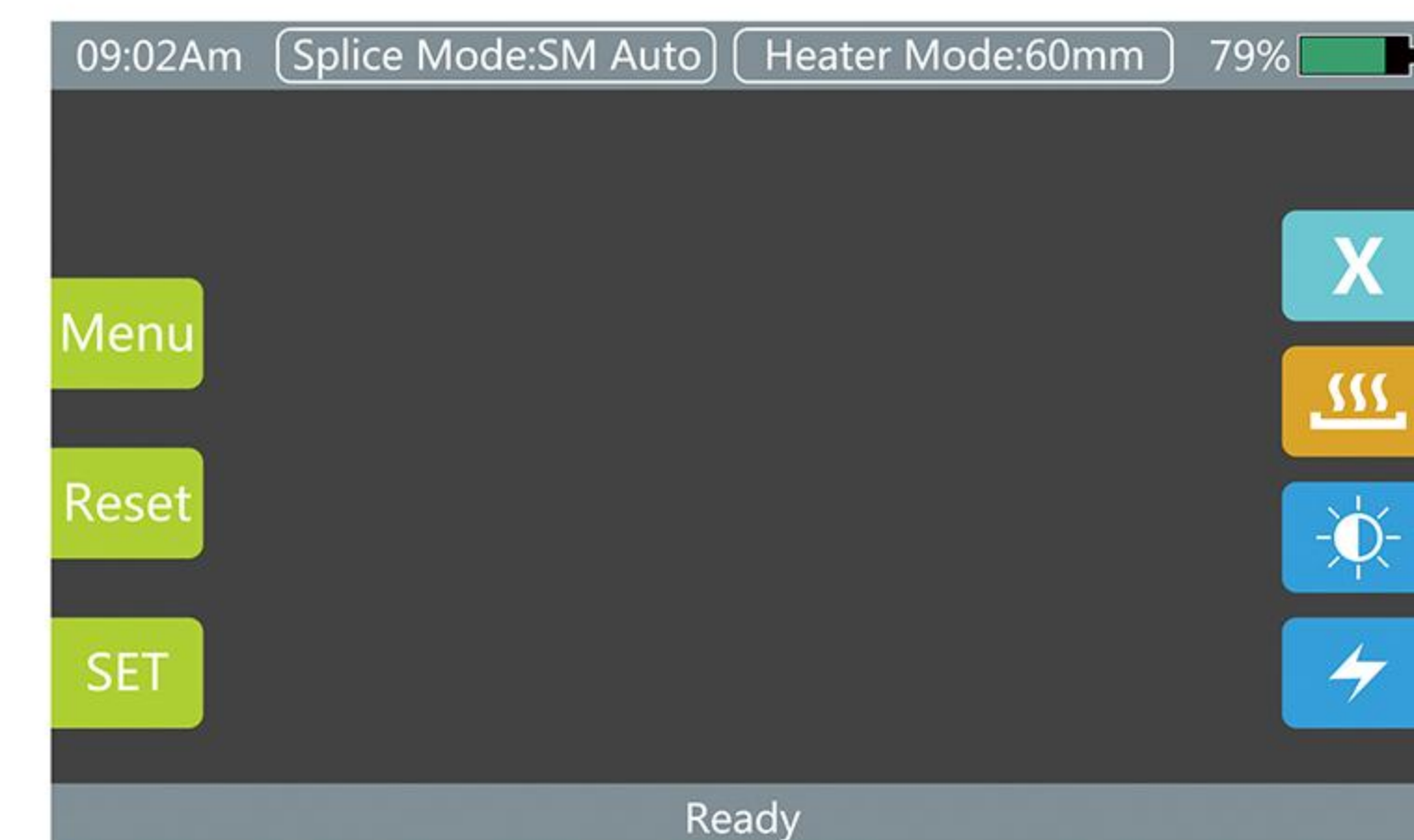

#### 4.4 Adjust the brightness of LCD backlight

In the initial interface, press the  to adjust the LCD backlight brightness until clear.

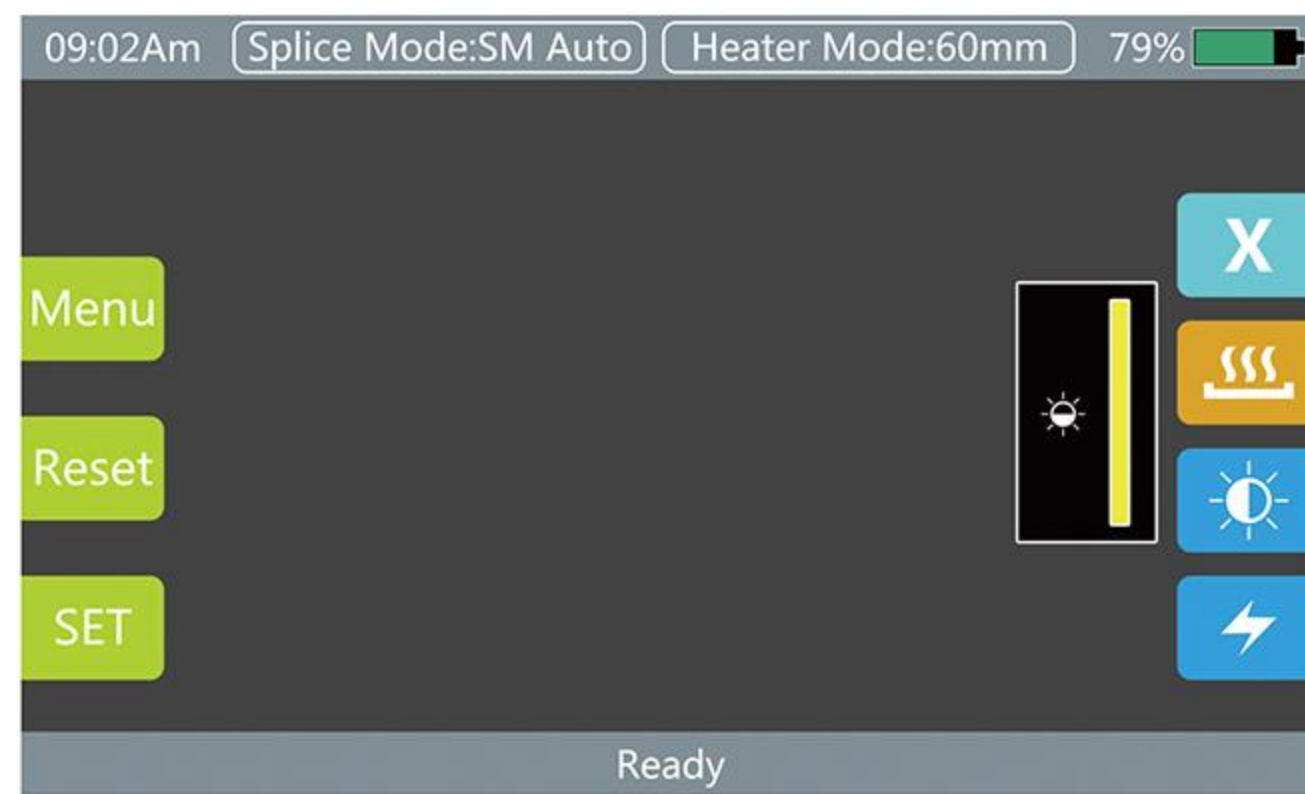

#### 4.5 Preparation steps for fibers

There are three steps for preparing for fibers before splicing:

- Coating stripping.

At least peel off the jacket leaving 50mm coating (loose and tight set of fiber). Remove the coating with a stripper, the length should be 30~40mm.

- Use cloth or cotton paper immersed by only 99% or better purity alcohol to clean the fiber.

- Cleave the fiber.

Use high precise cleaving machine to cleave the fiber. To ensure the splicing quality, fiber cleaver should be used, such as 9C series cleaver, and control the cleaving length strictly, like below.

**Tips: Remember to fit the heat shrinkable sleeve during fiber pretreatment.**

**Important!** Make sure the bare optical fiber and its cleaving surface are not stained.

- Avoid putting the fiber in dirty table

- Avoid fiber swaying in air

- Check whether the V groove and hammer are clean, if not clean, it must be cleaned with alcohol swab.

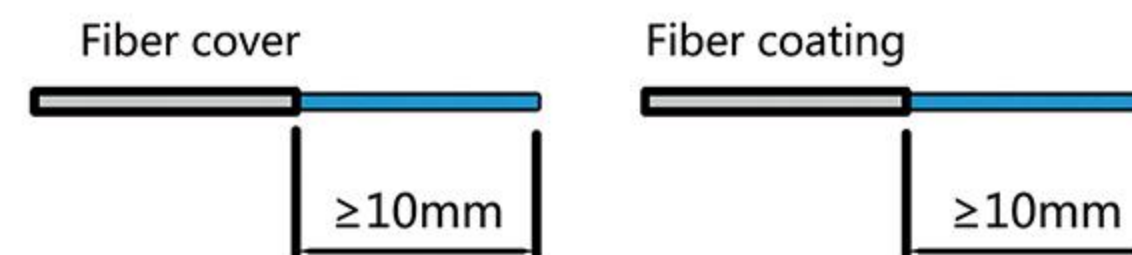

#### 4.6 Automatic inspection of optical fiber

After placing the fiber, fusion splicer starts, and there will be discharging cleaning. After that, check the splicing angle and splicing quality of the cleaving surface. Buzzer will alarm if the angle is bigger than the limited value or glitch on the cleaving surface, and there will be warning on the monitor.

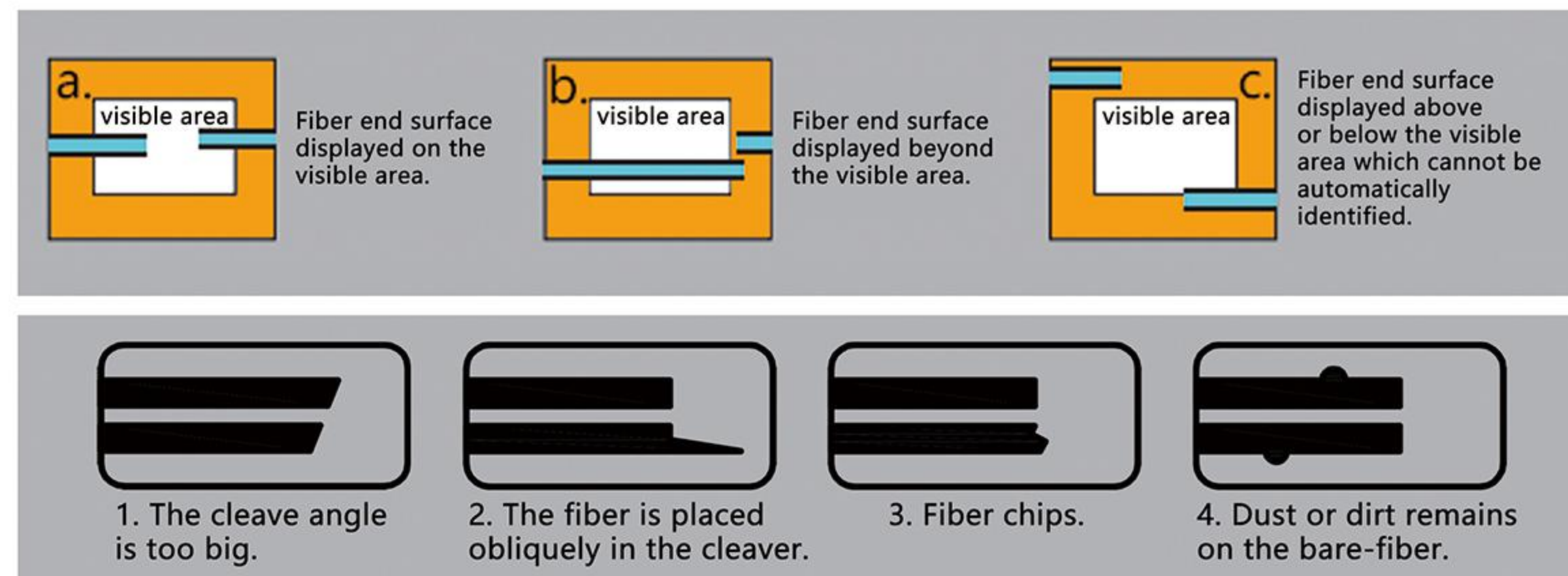

#### 4.7 Splicing procedures

- ① Turn on the power, when splice SM fiber (ITU-T.G. 652), SM mode is suggested.
- ② Confirm splicing and heating mode, when splice different types of fibers, Auto Mode is suggested, splicing speed will be slower.
- ③ Clean the fiber or heating shrinkable tube. Penetrate the fiber into heat shrinkable tube.
- ④ Stripper the fiber and clean it with 99% or better purity alcohol.

Make sure the coating trash or dirt is cleaned out.



- ⑤ Pls protect the cleaved fiber end from any touching of hard object.
- ⑥ Set the fiber between the V-groove and two electrodes.
- ⑦ Close the winder-proof cap, automatic splicing starts, visual inspection on LCD while splicing.

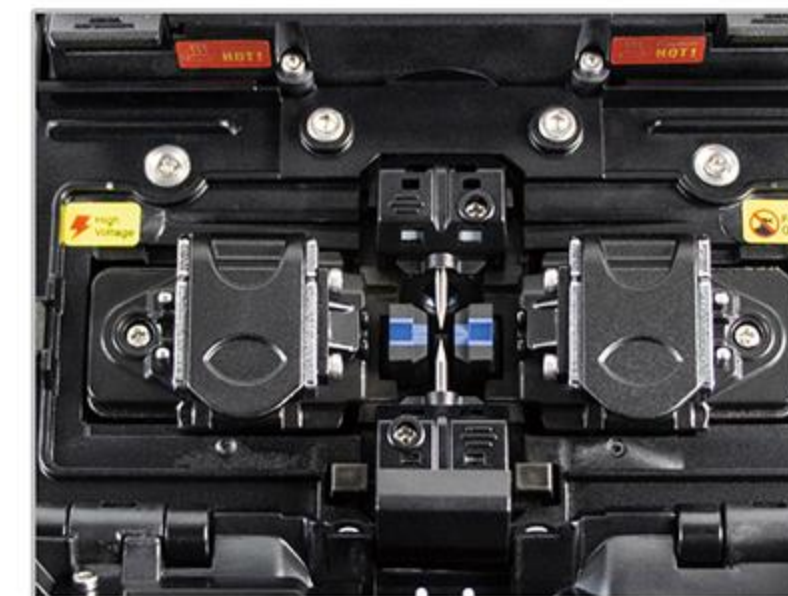

**Attention: please don't slide the fiber along the V-groove. The cutting section should surpass the V-groove but not beyond the tip of the electrode.**

- ⑧ Remove the spliced fiber, centering protective sleeve in heat tanker, centering the splicing point in heat sleeve, heating automatically starts when cover closed.



- ⑨ Completed.

**Attention: when the splicing loss or the altitude change is big, Electrode stabilize and ARC calibration must be executed.**

#### 4.8 Magnification function of the screen

Users can double click the screen to magnify the monitor so as to inspect the splicing crack and estimate the splicing state.

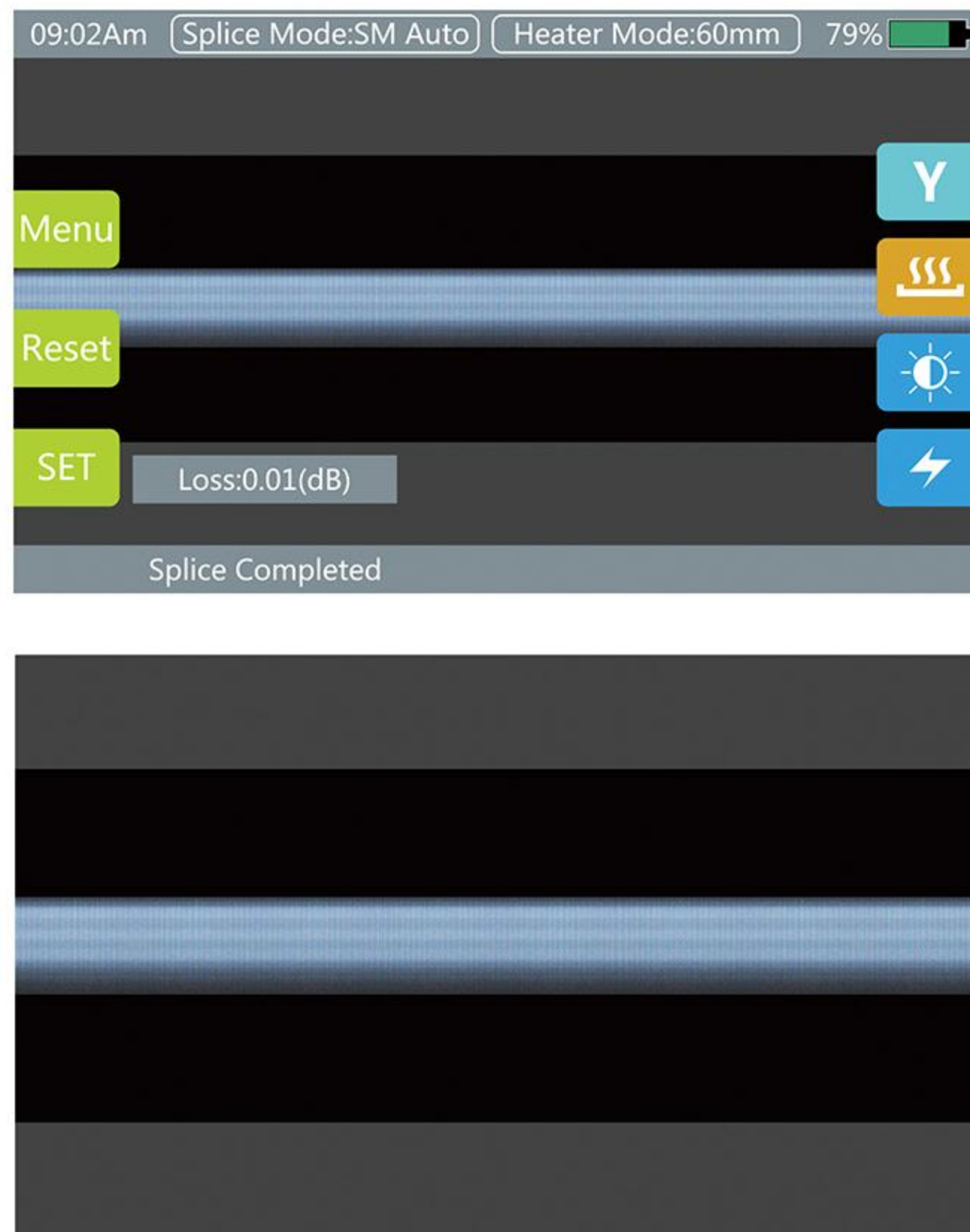

## 05. Splicing Mode

The menu is concise and easy to operate. Each splicing mode defines the splicing current, time and other important parameter. It's vital to select the right splicing mode. There is a pre-defined value of the usual fiber composite fusion pattern. In this way, it becomes easier to modify the splicing mode and optimize the combination parameter of the uncommonly used fiber.

### 5.1 Display of the current splicing mode



Current splicing mode.

### 5.2 Selection of the splicing mode

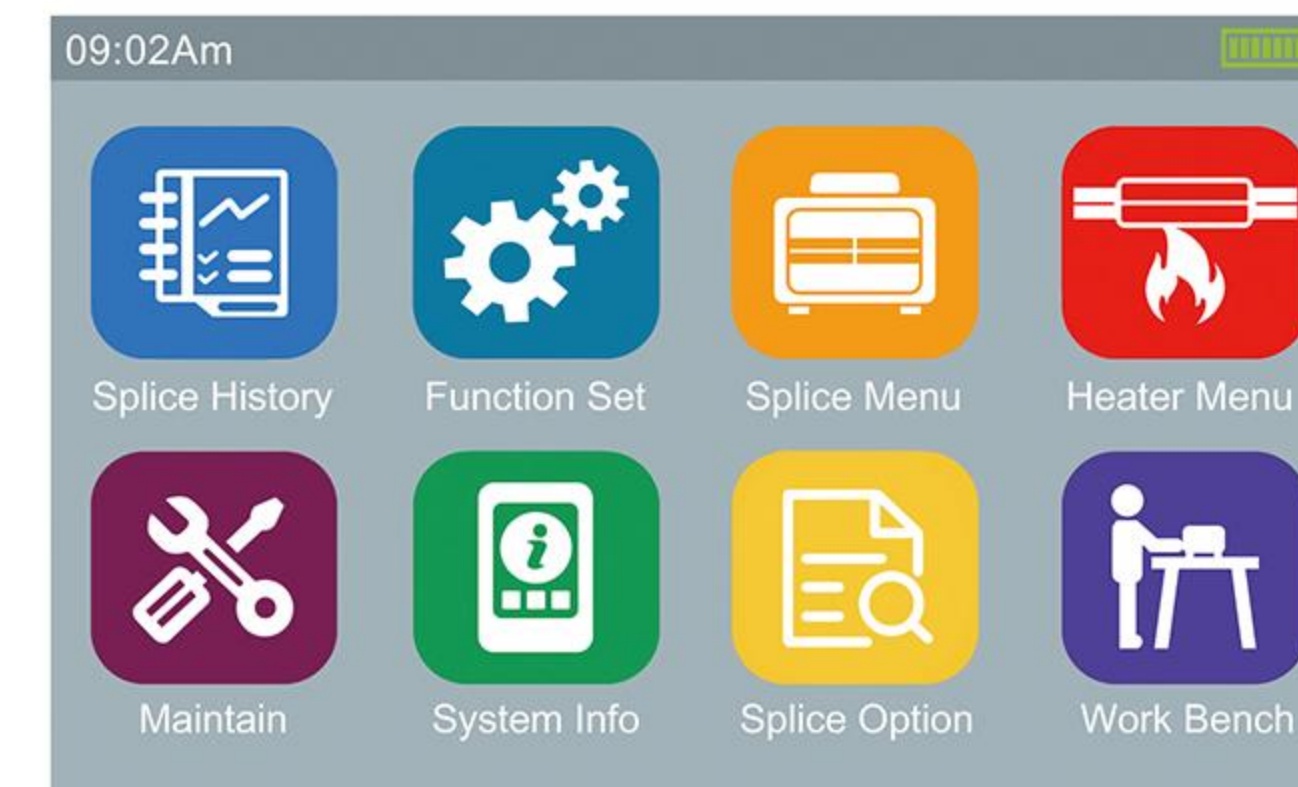

Click enter [Splice Menu].

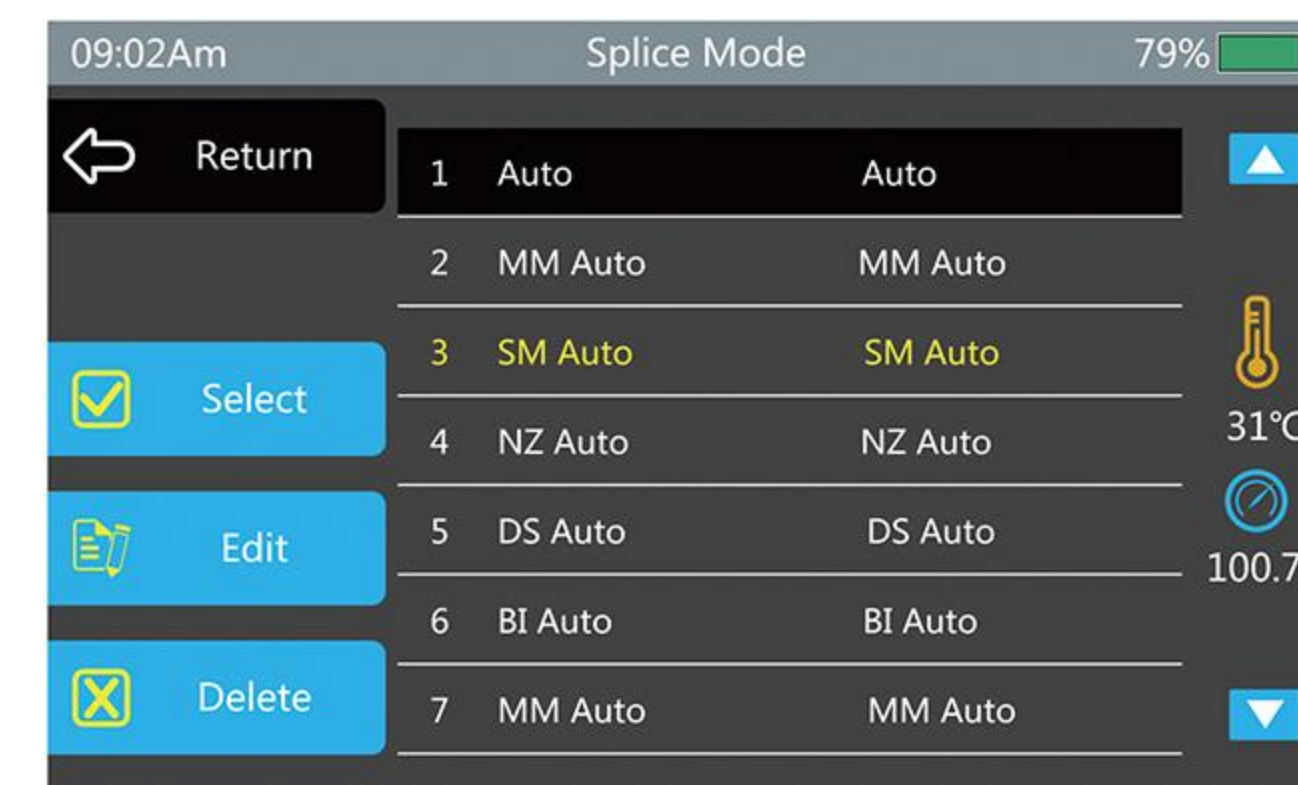

Enter into the splicing mode and select and press the needed one (yellow font is the current splicing mode). Check the chosen splicing mode and press "Return" to return to the initial interface.

### 5.3 Parameter in general splicing

Parameter	Description
Mould	A list of splicing patterns stored in fusion splicer can be copied to the user editable area according to user selected splicing mode.
Name	Heading of Splicing mode not more than 7 characters.
Annotation	Detailed explanation for splice mode less than 15 characters. Display in [select splice mode] menu.
Pull test	If [pull test] is set [on], after splicing, open the winder-proof cap, or press [set] button to do pull test.
Estimated loss	The estimated loss is an estimate of splicing loss. The fusion splicer calculates the loss of the splicing point according to the optical fiber image, and has some deviation from the real value. The loss estimation algorithm is based on single-mode optical fiber with a transmission wavelength of 1.31 $\mu$ m. The estimated value has good reference value in the case of good welding condition, but it can not be used as the basis for acceptance of the project.
Cleaving angle	The cutting angle of either side of the optical fiber is beyond the selected cutting angle limit, and error information is displayed.
Space	Set the alignment and pre-melting discharge, the distance between the left and right fiber ends.
Overlap	Set the overlap amount of fiber pushing, if the [pre-discharging strength] is low, then smaller [overlap] is recommended and vice versa.
Clean discharge time	The clean discharge can burn the tiny dust on the surface of the fiber in a small discharge cycle, and the discharge time can be changed by this parameter.
Clean discharge strength	Set clean discharge ARC strength.
Prefabricated discharge strength	Set the pre-discharge strength from the start of discharging to fiber pushing. If [pre-discharging strength] is set too low, then the axial deviation of the fiber will occur when the fiber cleaving angle is relatively poor. If too high, excessive melting of optical fiber ends will lead to greater loss of fusion.
Prefabricated discharge time	It is possible to set the same discharge time from the start to the start of the fiber advance, and the long [pre-fusing discharge time] and the high [pre-flush discharge intensity] result in the same result.
Strength of ARC	Set the ARC strength.
Splicing ACR time	Set the ARC time.

## 06. Splicing Options

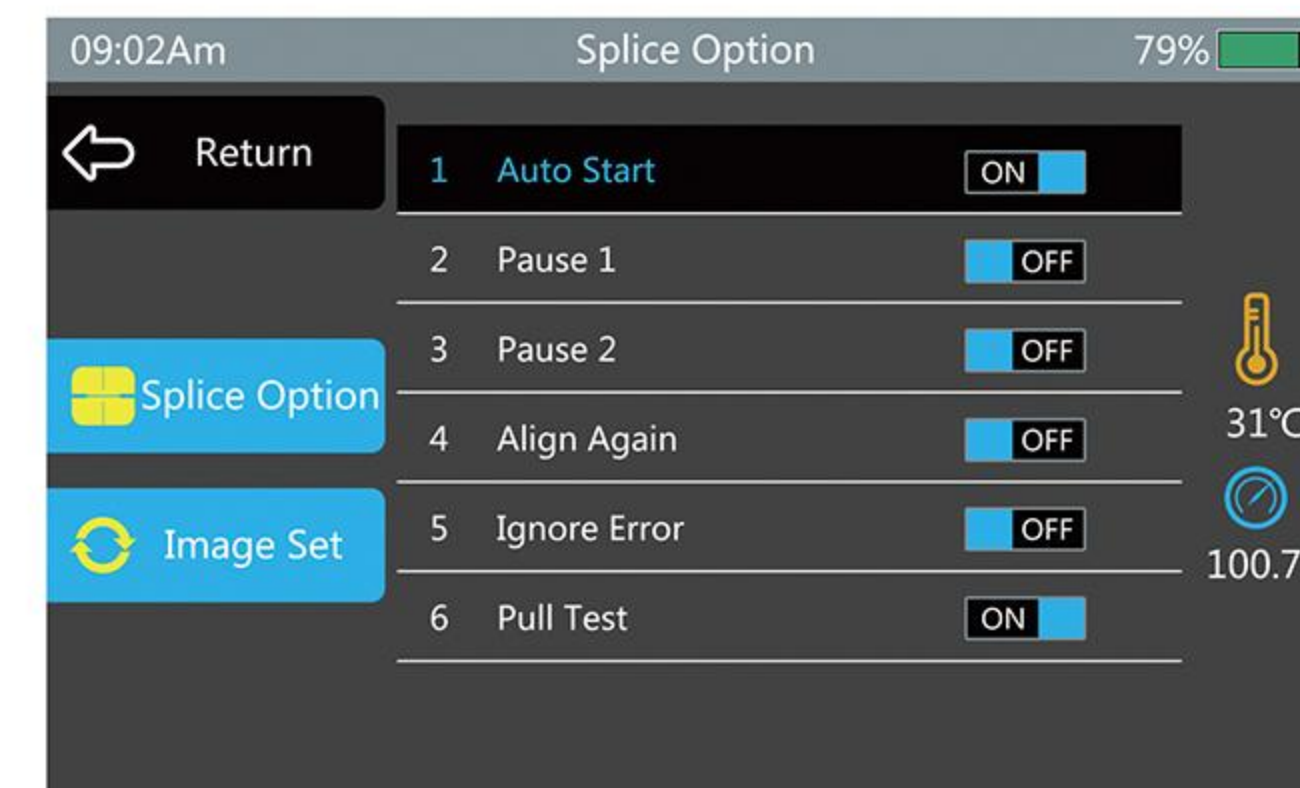

Enter into [Splice Option] menu.  
Click and choose item, modify parameter.

Name	Parameter	Description
Splicing options	Automatic starts	If Automatic start is set "on", splicing starts when the winder-proof cap is closed. Fiber should be prepared in advance and put into the fusion splicer.
	Pause one	If [pause one] is set "on", splicing will be ended when the fiber is pushed in right place, and user can see the cutting angle.
	Pause two	If [pause two] is set "on", splicing will be ended after completion of alignment.
	Alignment again	Alignment will lose efficacy after long state of [pause two], after which, fusion splicer will align again. If Alignment again is set "off", when fiber axial displace, it's suggested to choose manual splicing mode instead of alignment again mode.
	Faulty ignorance	Neglect the splicing fault, such as the cutting angle is bigger than the maximum value. If set this function "on", splicing can be continued.
	Pull test	If pull test is set "on", then when splicing completed, turn on the winder-proof cap, pull test could be executed.
Fiber image set	Fiber space set	Set the fiber display while splicing.
	Pause one	
	Alignment	
	Pause two	
	Discharge	
	Estimate	



## 07. Heating Mode

There are 50 heating modes stored, 5 default heating modes, user can define and add as them like. Choose the best heating mode match the used heat shrinkable tube. For each heat sleeve, user can edit and define the corresponding parameters.

### 7.1 Selection for heating mode

Choose and enter into [Heater Menu].

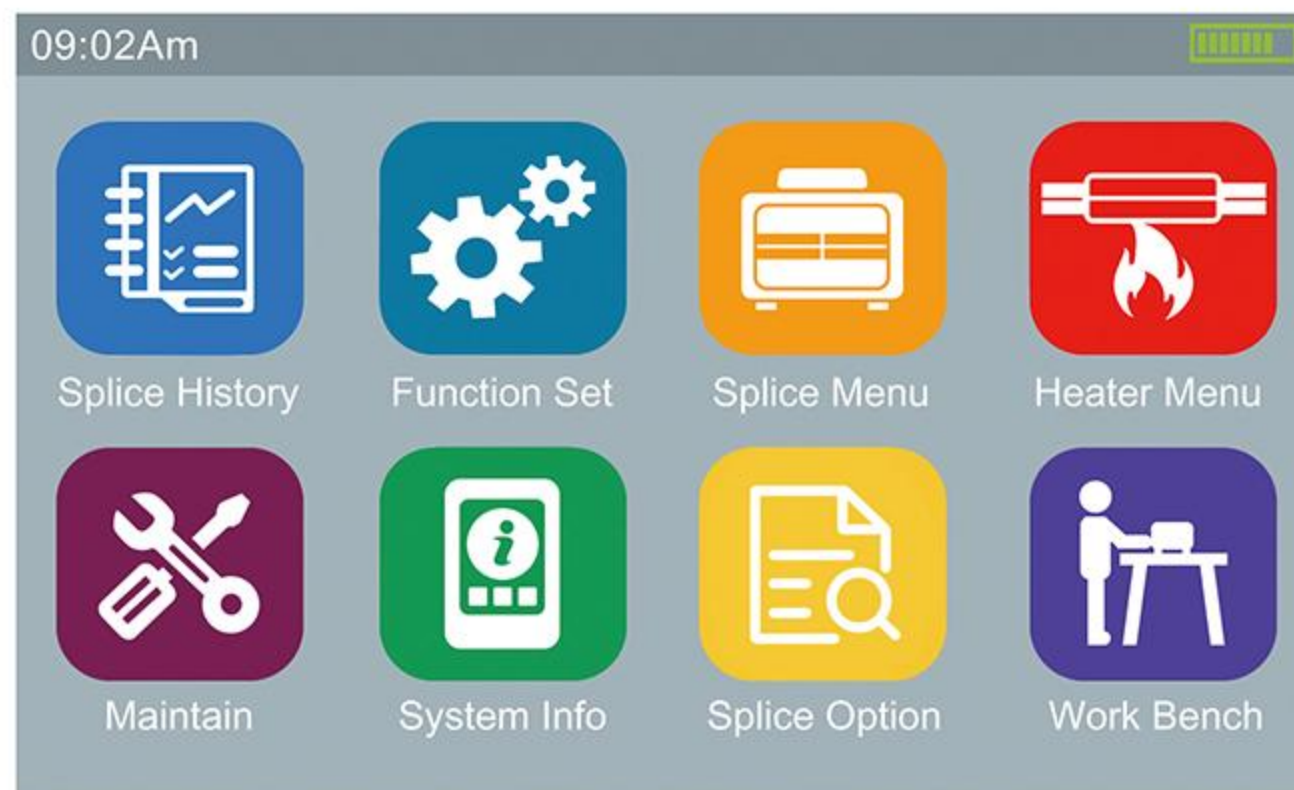

Enter into [Heater Menu].

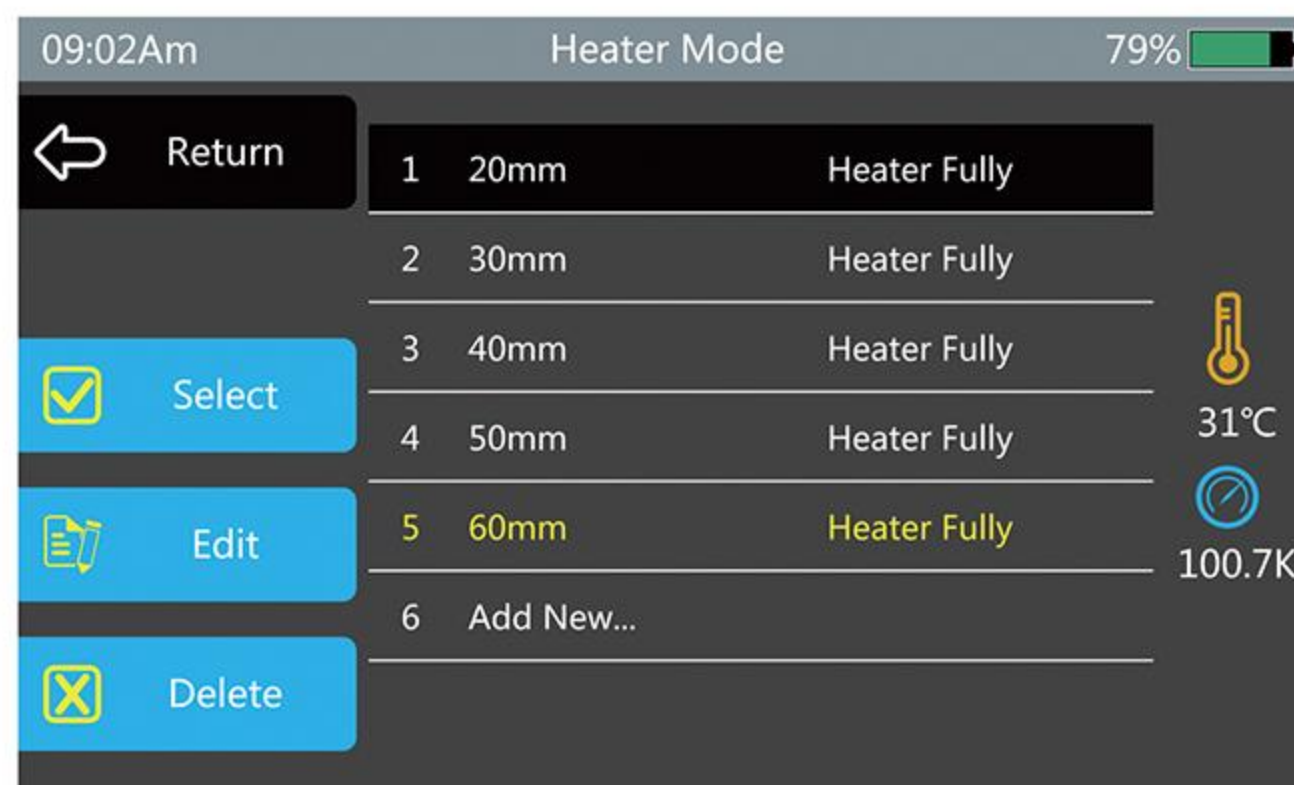

Enter into [Heater Menu], choose the needed mode, then press until the font become yellow; this is the current splicing mode.

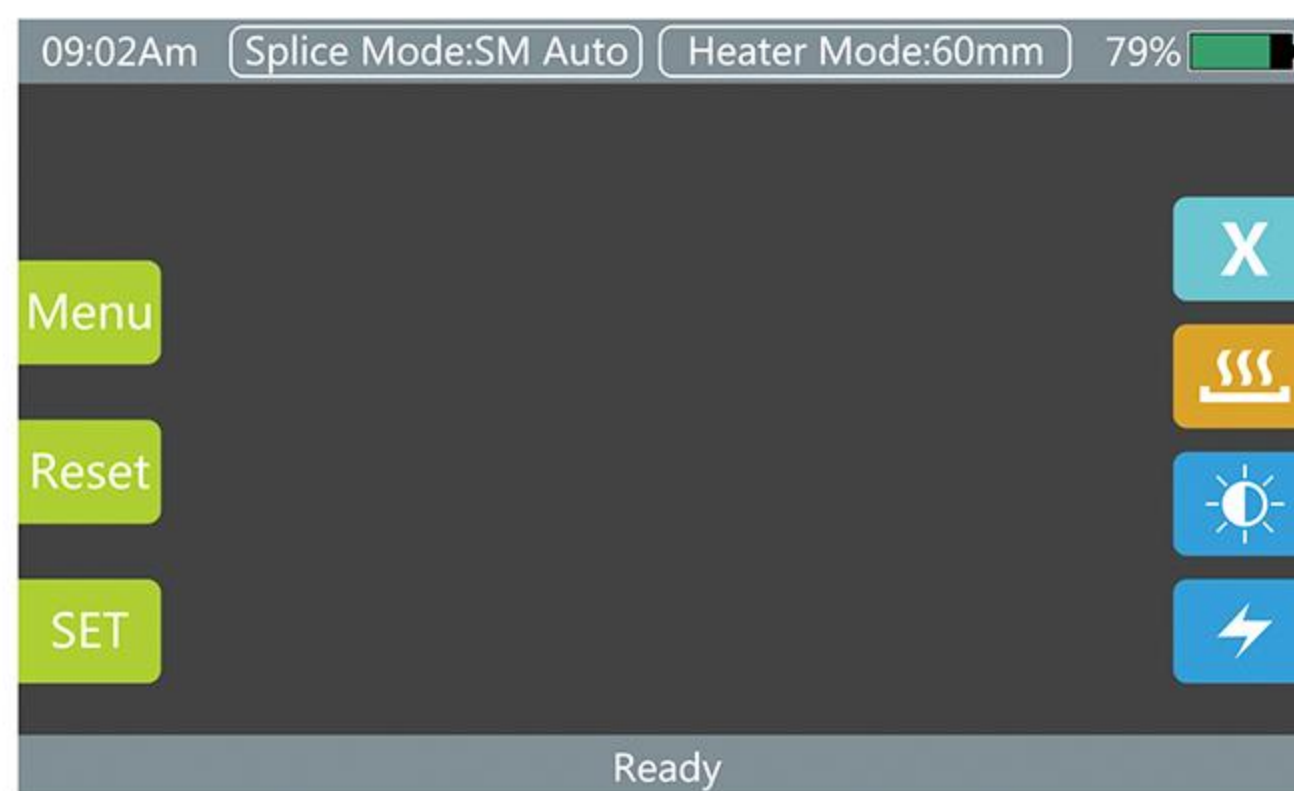

Check the chosen heating mode, press back to return to the initial interface.

### 7.2 Edit the heating mode

Heating conditions stored in "heating mode" can be edited and modified.

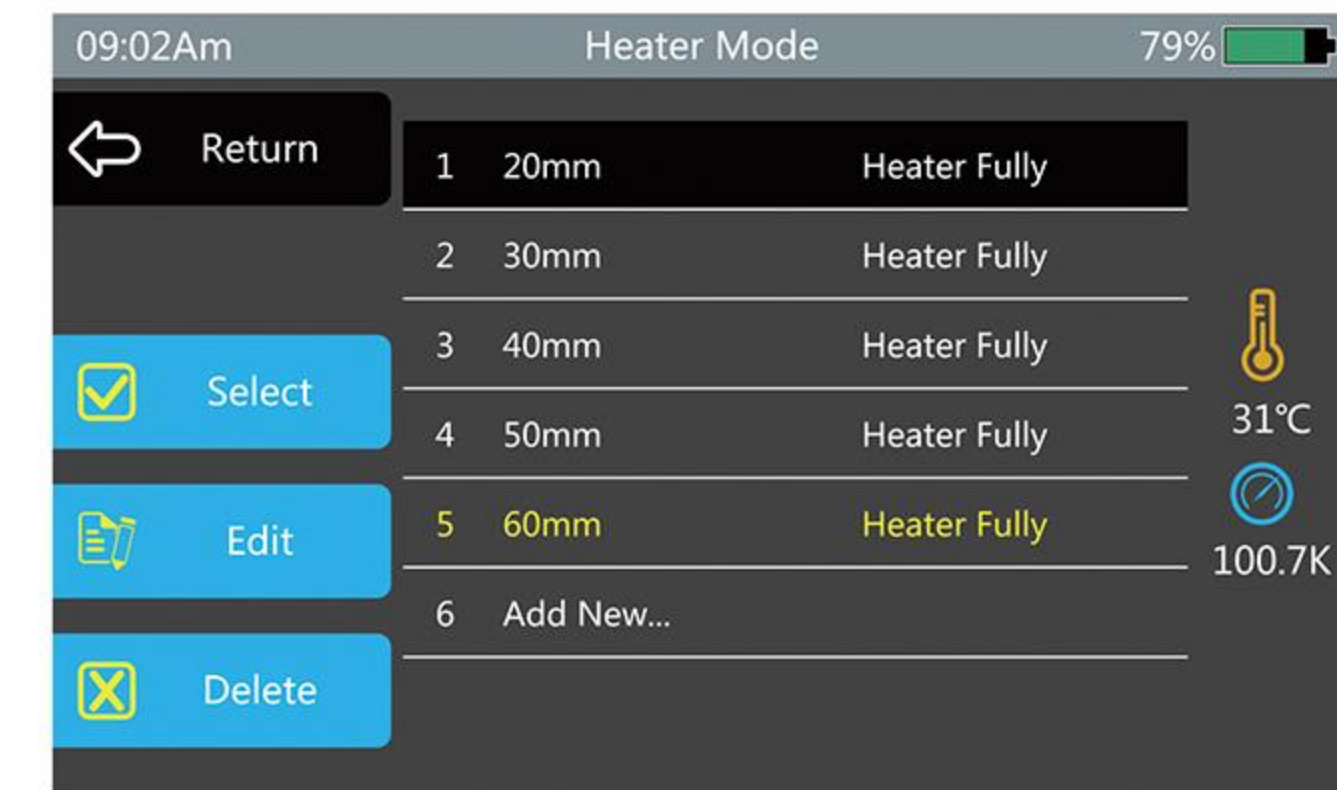

Enter into [Heater Menu] and edit, select [Edit] to enter into [Edit Heater Mode].

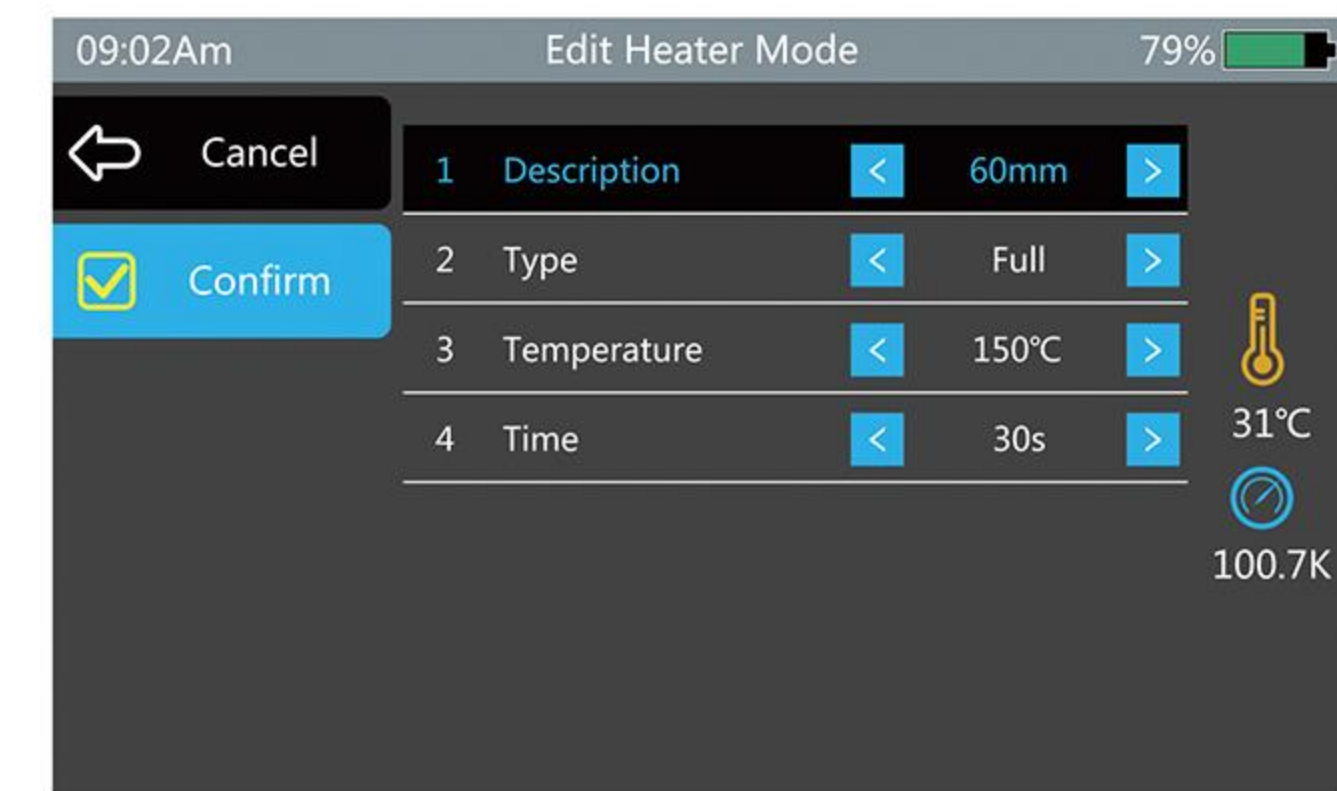

Choose and edit the parameter, after which, press [Confirm].

### 7.3 Delete heating mode

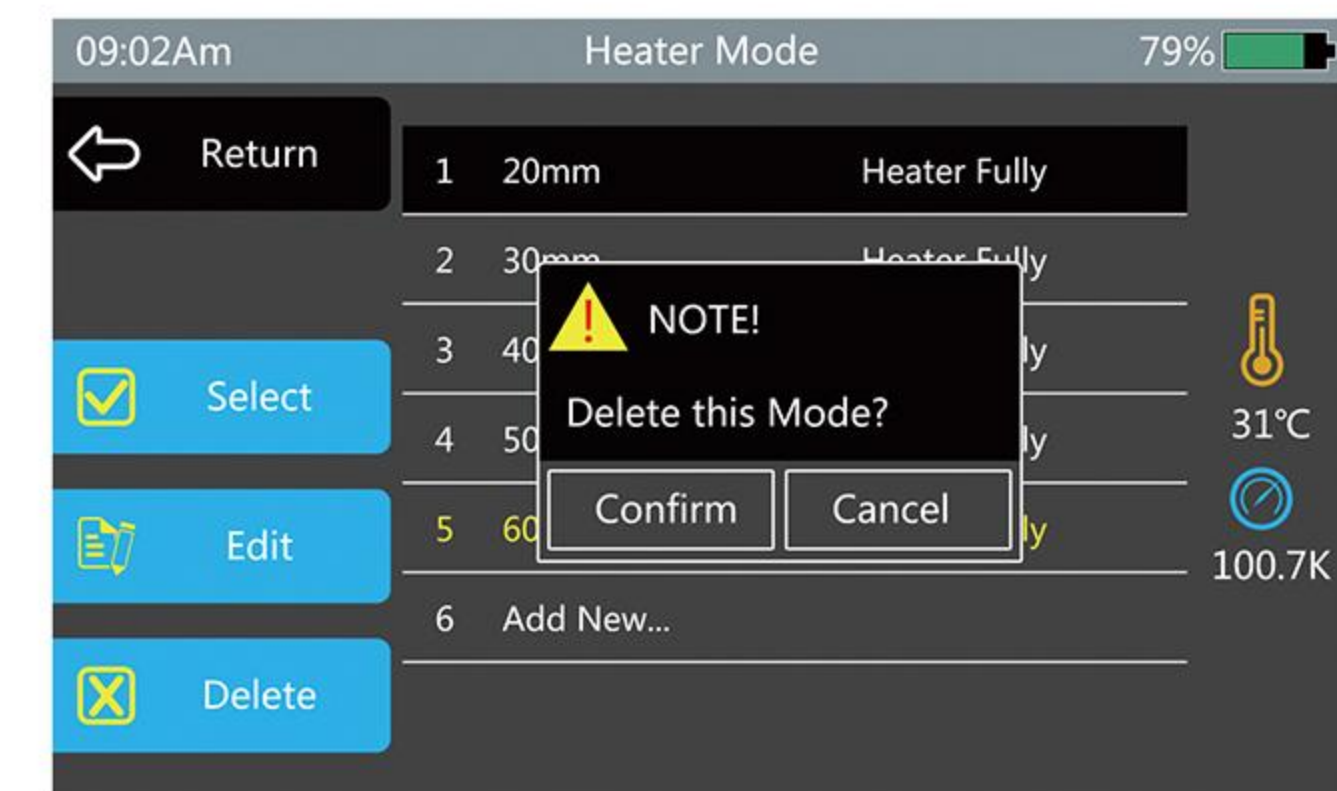

Enter into [Heater Menu], choose the mode you want to delete, press [Delete], press [Confirm] on the tooltip.

Parameter	Description
Name	Name of heating mode.
Heating type	Select [full] (heating all) or [part] (heating part of it) according to users requirements.
Heating temperature	Set heating temperature.
Heating time	Set the heating time from start to end.

## 08. System Maintenance

### 8.1 Dust checking

The fusion splicer detects the dust on fiber, camera or objective by imaging, which can influence the splicing result. This function can detect the dust on the optical channel and judge whether it will influence splicing quality or not.

#### Operations

- Choose [dust checking] in [system maintenance].
- If fiber already set in the fusion splicer, take out the fiber and press [set] to start dust checking.
- If dust is found while checking, [executive failure] will be noted on monitor. Clean the objective and perform dust checking again, until it shows [operation completed].

**Attention: if the dust still remains after cleaning, please contact the agent or manufacturer.**

### 8.2 ARC calibration

Motors are adjusted before exit-factory. Certainly, these settings may change for a variety of reasons. This function automatically calibrates the speed of 6 motors.

#### Operations

- Choose [ARC calibration] in [system maintenance].
- Prepare for the fiber and put into fusion splicer, press [set].
- Speed of all motors will be automatically calibrated, and will hint for completion.

### 8.3 Electrode stabilize

When the environment changes dramatically, the discharge strength will become unstable which will increase the splicing loss, especially when it changes from low altitude to high altitude, it needs some time to stabilize the discharge strength. Under this condition, electrode stabilize would need to be performed for several times until it shows [stabilize finished].

#### Operations

- Select [electrode stabilize] in [system maintenance].
- Put the prepared fiber into fusion splicer.
- Press [set], it will starts to stabilize electrode automatically according to following procedures.
  - (i) Discharge repeated for 5 times to ensure the place of electrode.
  - (ii) Splicing the fiber quickly.
  - (iii) The electrode position is accurately measured 16 times of electrode stabilize.

### 8.4 ARC calibration

Atmosphere like temperature, humidity, air pressure are always changing. This makes the discharging temperature change as well. The machine is equipped with temperature and air pressure sensor which can give feedback to the control system to adjust the discharge intensity to maintain a steady state. Automatic calibration is not suitable for changes caused by the wear of motors and fiber trash adhesion, and the center position of discharging sometimes moves to the left or right. In this condition, the fiber will be shifted relative to the discharge center, ARC calibration will be needed.

**Attention: Discharge calibration changes the internal condition parameter not the discharging strength in splicing mode.**

#### Operations

- Select [ARC calibration] in [system maintenance], display the calibration image.
- Prepare the fiber into fusion splicer, press [set] to start calibration until it shows "completion", or cleaving the fiber and do it again, don't exit the discharging calibration page.

**Attention: ARC calibration should be performed for several times until success.**

### 8.5 Electrode setting

The splicing loss will be enlarged and splicing strength will be reduced when the discharging times exceed the electrode life. The electrode is worn by use and must be regularly cleared according to the concentration of the oxide. Set a reminder when the electrode was used for 2000 times, and it is recommended to update new electrode bar when splicing over 2000 times.

When over 3000 times, there will be [please change the electrode bar] reminder when turning on.

- When change the electrode bar, please press [replace electrode] in [electrode setting] or turn off the power and change.
- Loosen the screw on the electrode, take off the old electrode bars.
- Be careful not pull the wiring out when replacing the electrode bars.
- Clean the new electrode bar with a clean swab or dust-free cloth dipped in alcohol, then install to the fusion splicer, place the electrode cover and tighten screws.
- It is strongly recommended that after replacing the electrode, electrode stabilize and discharge calibration should be done (operations are described below), or else splicing loss and strength cannot be assured.

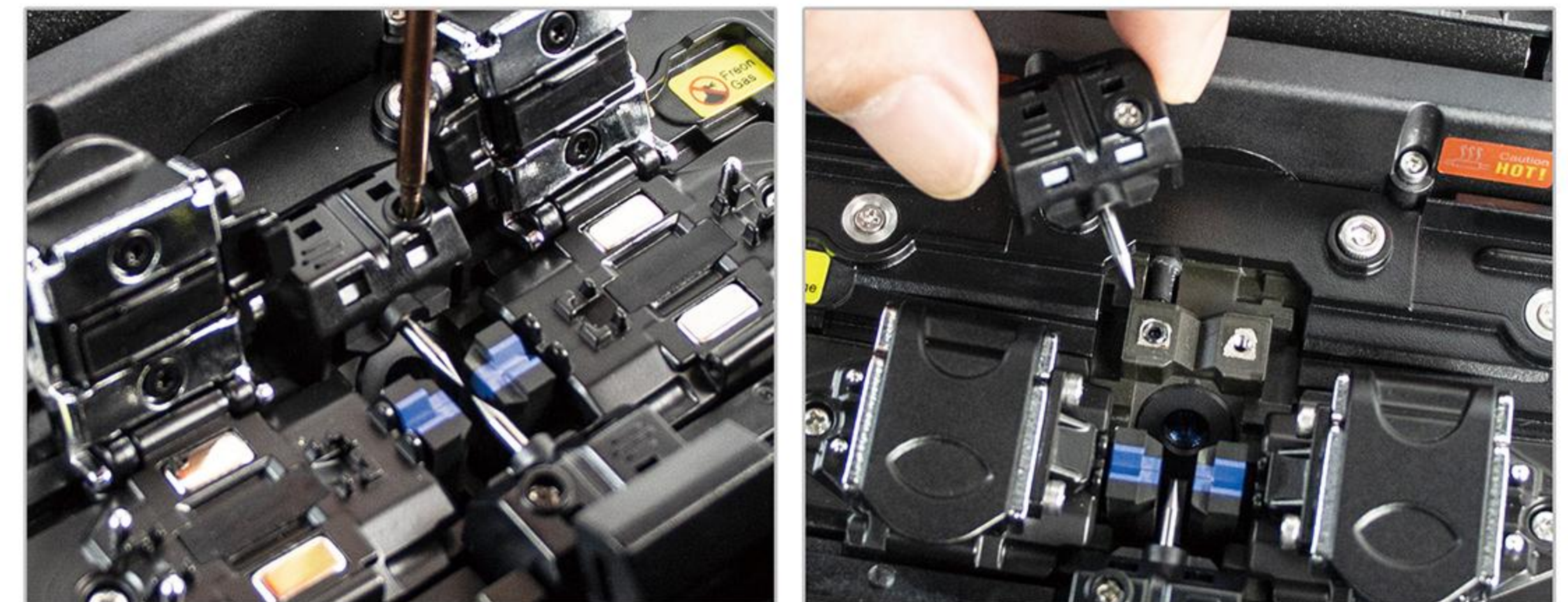

## 09. Other Function And Applications

### 9.1 Records storage

Utmost 20000 splicing results can be stored. According to different splicing modes, the storage contents are different.

#### Display of splicing records

- The storage results can be displayed in fusion splicer.
- Enter into [splicing records] menu, select [splicing records display] and inspect.

#### Delete splicing records

- Select [delete splicing records] option, input password of the fusion splicer and press [Enter] to delete all splicing records.

#### Cancel data storage

- If the user does not want to store the splicing records, please press [OK] in [Stored Records].

### 9.2 System settings







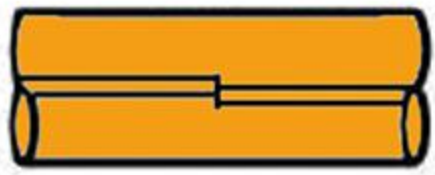

Parameter	Description
Buzzer	Set the turn on/off switch.
Temperature unit	Set the display way of temperature.
Automatic heating	If select [NO], when fiber is put into heat tanker, it will automatic start to heat.
Language	Select the operating language.
Calendar	Set system time.
Password	To enter some special menu, the factory sets the initial password [000000]. If the user forgets their changed password, please contact local agent.
Electrode use reminder	There will be a reminder [please change the electrode bar] when the electrode discharging times exceed the set parameter. And it is recommended to set it as [2000] times.
Electrode use warning	When the discharging times exceed the set data, there will be warning after turning-on [must change the electrode bar], and it is recommended to set this as [3000] times.
Turn off the monitor automatically	If without any operations, monitor will be turned off automatically within 180 seconds (user can change this) to avoid loss of electricity. When display screen turns off, LED lights next to the "turn on/off" key will flicker, and screen can be opened again by pressing any keys.
Turning off automatically	If without any operations, fusion splicer will be turned off within 30 minutes (user can define this data) to avoid loss of electricity.

### 9.3 System information

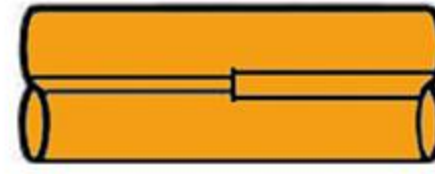
Select [system info], below message will be shown.

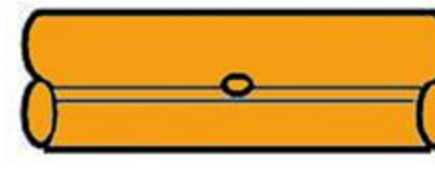
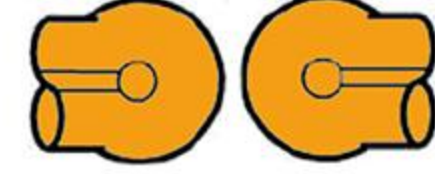
Parameter	Description
Version of software	Display the version of software.
Discharge statistic	Display the discharging times.
Manufacturer	Display the name of manufacturer.
Serial No.	Display of the serial Number.
Model Type	Display the model type of the fusion splicer.

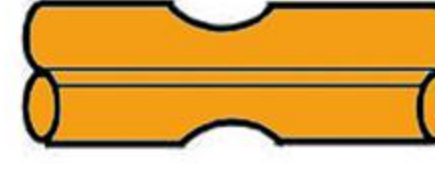
## 10. Excessive Splicing Loss And Solutions

Image	Definition	Reason	Solution
	Fiber core axial deviation	there is dust on V-groove or fiber clamp.	Clean V-groove and fiber clamp.
	Fiber core angle error	there is dust on V-groove or fiber clamp. Poor quality of fiber end face.	Clean V-groove and fiber clamp. Check the fiber cleaver working state.
	Fiber core bending	poor quality of fiber end face. low discharging strength or short discharging time.	Check the fiber cleaver working state. Enlarge [discharging strength] and/or [discharging time].
	Die field diameter mismatch	Discharging strength too low.	Enlarge [discharging strength] and/or [discharging time].
	Dust combustion	Poor quality of fiber end face. Dust is not cleaned or cleared when cleaning the fiber or discharging.	Check the fiber cleaver working state. Clear the fiber or increase the [cleaning discharging time].
	Bubble	Poor quality of fiber end face. Low discharging strength or short discharging time.	Check the fiber cleaver working state. Enlarge [discharging strength] and/or [discharging time].
	Fiber separation	Fiber pushing is too small. High discharging strength or long discharging time.	Perform [ARC calibration] maintenance. Reduce [discharging strength] and/or [discharging time].
	Too thick	Fiber pushing is too big.	Reduce [overlap amount] and execute [ARC calibration].
	Too thin	Discharging strength not suitable. Some discharge parameters are not suitable.	Execute [ARC adjust]. Adjust [splicing discharging strength] [discharging time] or increase [overlap amount]
	Splicing line	Some discharge parameters are not suitable.	Adjust [splicing discharging strength] [discharging time] or increase [overlap amount]

**Attention:** when splice different types of fibers (different diameter) or multimode fiber, sometimes there will be an upright line on the splicing point, we call it [splicing line], this doesn't influence the splicing quality (splicing loss and splicing strength).

## 11. Common Error And Solutions

When using fusion splicer, if there is error reminder, please refer to the following solution. If problems still cannot be solved, then must be mistaking in fusion splicer, then please contact the dealer for help.

Error message	Reason	Solution
Left / right fiber place error	The fiber end-face is placed on the electrode centerline or beyond it.	Press RESET, and set the fiber and end-face between the electrode centerline and the V-groove edge.
Pushing motor surpass limit	The fiber is not correctly set at the bottom of the V-groove.	Press RESET, and put the fiber correctly.
Fiber end face in touch	[overlap] is set too low.	Adjust [overlap] parameter.
	Motor is not calibrated.	[Motor calibration] maintenance.
Fiber tracking failed	The fiber is not put correctly at the bottom of the V-groove.	Press RESET and replace the fiber correctly at the bottom of the V-groove.
	The fiber is not located in the camera's field of view.	Check the position of stripped fiber on the fiber cleaver.
	The cleaved length (bare fiber part) is too short.	Check the cleaved length.
Cleave angle abnormal	Bad quality of fiber end-face.	Prepare fiber again. If problem remains, check the condition of the blade. If the blade is worn, rotate the blade.
	[Clean angle limit] is set too low.	Set the [Clean angle limit] to an proper value. (Standard 3.0°) .
Core angle abnormal	[Core angle limit] is set too low.	Set the [Core angle limit] to an proper value. (Standard 1.0°) .
	There is dust on V-groove or fiber clamp.	Clean the V-groove and fiber clamp, and prepare the fiber and put it again.
Fiber is dirty	Dust or dirt is on the fiber surface.	Completely prepare the fiber again.
	Dust or dirt is on the objective lens.	Clean the lens and execute [dust checking], clean the lens if dust or dirt exists.
	[Clean ARC] time is too short.	Set the [Clean ARC] time to 180ms.

## 12. Common Malfunctions And Solutions

For user's reference when they have problems, solutions to some common malfunctions are listed below. If problems still remain, please contact the local agent.

Malfunctions	Solutions
Press ON/OFF Key, cannot turn on/off the machine	Press the ON/OFF key for long time till the LED lights flickers, release the key, fusion splicer shut off.
Full battery cannot complete several times of splicing	When the memory effect occurs when the battery is reduced or after a long period of storage, the battery should be completely let go, and then recharge the battery.
	Battery worn, change the battery.
	Use the machine under too low temperature.
Splicing loss is big	Clean the V-groove and fiber clamp.
	Replace the electrode bar, ARC calibration and electrode stabilize.
	Cleaving angle of the fiber, discharging condition and cleaving state will influence the splicing loss.
The monitor is suddenly turned off	If without any operations, monitor will be turned off automatically within 180 seconds (user can change this) to avoid loss of electricity. When display screen turns off, LED lights next to the "turn on/off" key will flicker, and screen can be opened again by pressing any buttons.
The splicer suddenly shuts down	The splicer turns off automatically when the machine is set for automatic machine shutdown (default 30 minutes) without any operations.
Fiber identification Errors under AUTO mode	AUTO mode only for standard SM, MM, NZ optical fibers. When splice special fibers, AUTO mode may not recognize correctly.
The estimated loss is different from the real loss	The estimated loss is evaluated just for reference.
	The optical components needed to be cleaned.
Heat shrinkable tube doesn't shrink completely	Extend the heating time.
How to cancel heating	If user want to terminate the heating, press HEAT button, then the LED light will go out.
The heat shrink tubing is stuck in the heating tank after heating	Remove the heat shrink tubing with a thin cotton swab or soft bar.
Forget Password	Contact Agent or Distributor.
After discharge calibration, the discharge intensity did not change	The discharge calibration changes the internal condition parameters not the discharging strength.
Forget to put fiber when fiber is needed to be put in the maintenance	Press Back button is invalid, winder-proof cover should open, and the cleaved fiber be put into fusion splicer, press [set] to continue.

★ Our products performance and indicators are under continuous improvement, subject to change without further notice.

★ The picture in this manual is for reference.

### Key Panel



**ON/OFF Key:**  
Power ON/OFF

**UP/DOWN Key:**  
Move Cursor  
Change Value

**ENTER Key:**  
Enter Of Value

**EXIT Key:**  
Return To Previous Screen

**SET Key:**  
Execute Splice

**RESET Key:**  
Stop And Back To Ready

**HEAT Key:**  
Heat Execute/Cancel

### Led Light Indication



**Turning ON**  
Press Key Until Blue LED Turns On

**Turning OFF**  
Press Key Until Blue LED Turns Off



**Heater LED (Red)**

### How To Recharge Battery Pack



- Input power: AC100-240V, 50-60Hz
- Use only supplied AC power cord.
- Do not stack battery pack on top of AC adapter while recharging.
- Confirm power saving function is working when using battery.

### How to check remaining capacity



### Cleaning Before Splice Operation

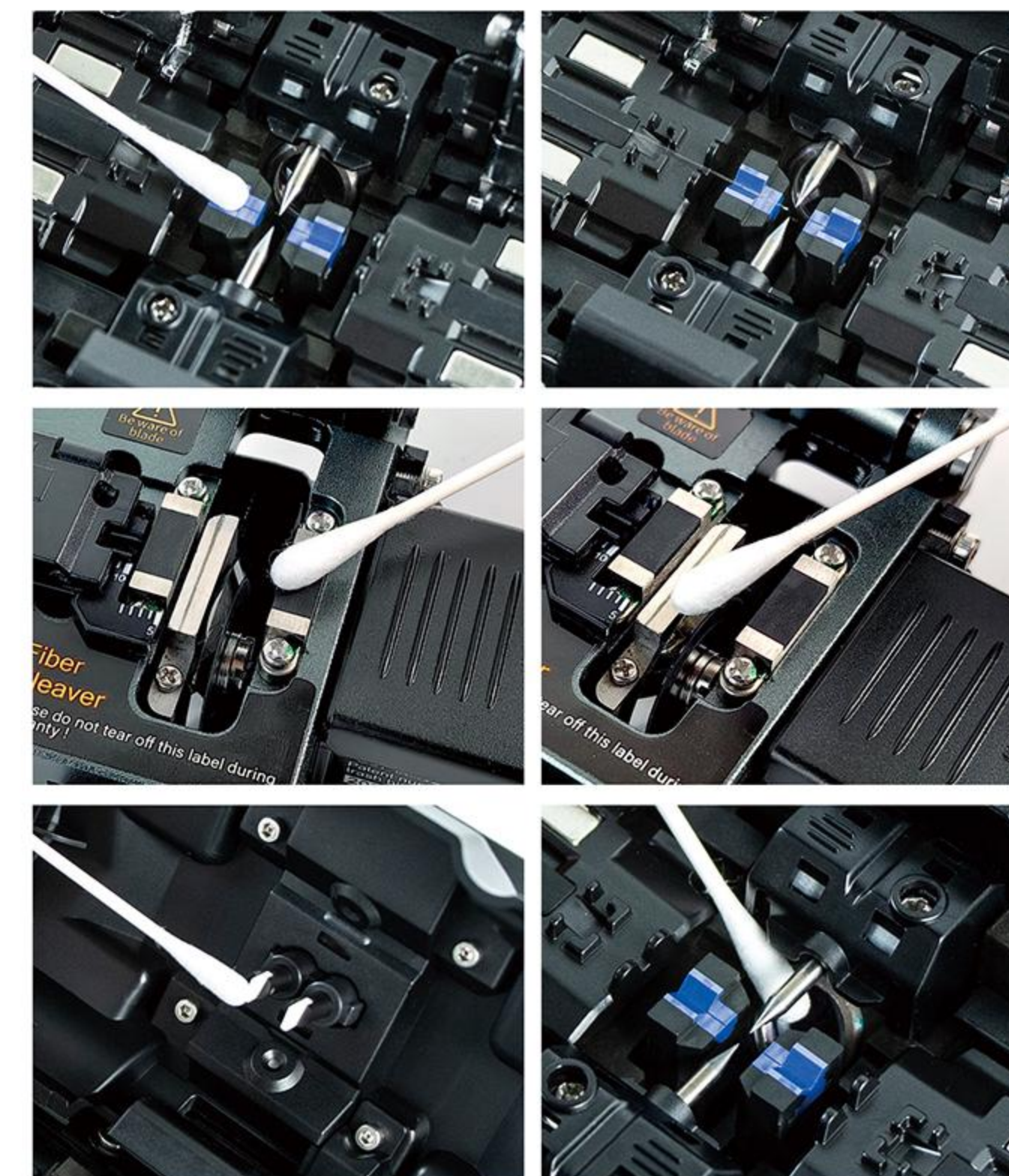

- V-grooves
  1. Clean bottom of V-groove with a thin cotton swab moistened with alcohol.
  2. Remove excess alcohol from V-groove with a clean dry swab.
  3. Use a cleaved fiber end-face to dislodge.

- Fiber Cleaver
  1. Clean rubber pads
  2. Clean rubber anvil
  3. Clean blade

- Fiber Clamp Chips and Objective Lens  
When lens is dirty, clean it.

#### Caution of Cleaning

- Do not contact the electrode tips
- Use only 99% or better purity of alcohol.

### Replace Electrodes

When “Replace electrodes” message appears, or when the tip is damaged, replace electrodes.

1. Execute **【Replace Electrodes】** in Maintenance Menu.
2. Use attached screw driver to replace electrodes.

- ① Loosen screws and remove the electrode cover
- ② Place the electrode cover and tighten screw.



- ③ Load prepared fibers onto the splicer. Execute **【Electrode Stabilize】** **【Arc Adjust】** is executed

### Ways Of Solution Of Common Error

Error Message	Reason	Solution
Left/Right fiber place error	The fiber end-face is placed on the electrode centerline, or beyond it.	Press RESET, and set the fiber end-face between the electrode centerline and the V-groove edge.
Press motor distance over limit	The fiber is not set correctly at the bottom of the V-groove.	Press RESET, and load the fiber correct.
Fiber end-face touch	<b>【Overlap】</b> is set too low. Motor is not calibrated.	Adjust <b>【Overlap】</b> value. <b>【Motor Calibration】</b> maintenance.
Fiber tracking failed	The fiber is not set correctly at the bottom of the V-groove. The fiber is not located in the Camera's field of view. The cleave length (bare fiber part) is too short.	Press RESET Key, Reload fiber correctly at the bottom of the V-groove. Check the cleave length (bare fiber part) on fiber cleaver.
Cleave Angle off normal	Bad fiber end-face.	Prepare fiber again. If problem remains, check the condition of the fiber cleaver. If the blade is worn, rotate the blade to a new position.
	<b>【Cleave Angle Limit】</b> is set too low.	Set the <b>【Cleave Angle Limit】</b> to proper value (Standard 3.0°)
Core Angle off normal	<b>【Core Angle Limit】</b> is set too low.	Set the <b>【Core Angle Limit】</b> to proper value (Standard 1.0°)
	Dust or dirt is on V-groove or Clamp.	Clean V-groove and Clamp Chip, Prepare fiber again, reload fiber
Fiber is dirty	Dust or dirt is on the fiber surface.	Completely prepare the fiber again.
	Dust or dirt is on the objective lens.	Clean the lens and execute the <b>【Dust Check】</b> . Clean the lens if dust or dirt exist.
	<b>【Clean Arc】</b> time is too short.	Set the <b>【Clean Arc】</b> time to 180ms.

### Steps Of Operation

- Turn splicer on
- ⬇ When splicing only standard SM fibers (ITU-T G.652.), “SM Mode” mode is recommended.
- Confirm splice and heater mode
- ⬇ When splicing different types of fibers, Auto Mode” is recommended, but splice speed is slow.
- Clean coating or sheath of fiber
- ⬇
- Place protective sleeve over fiber →
- ⬇
- Strip fiber
- ⬇
- Clean fiber →
- ⬇
- Cleave fiber
- ⬇
- Load fiber onto fiber holder →
- ⬇
- Splicing start automatically
- ⬇
- Visual inspection on LCD during splice
- ⬇
- Remove spliced fiber →
- ⬇
- Centering protection sleeve in tube heater
- ⬇
- Centering spliced point in tube heater
- ⬇
- Heating start automatically →
- ⬇
- Completed

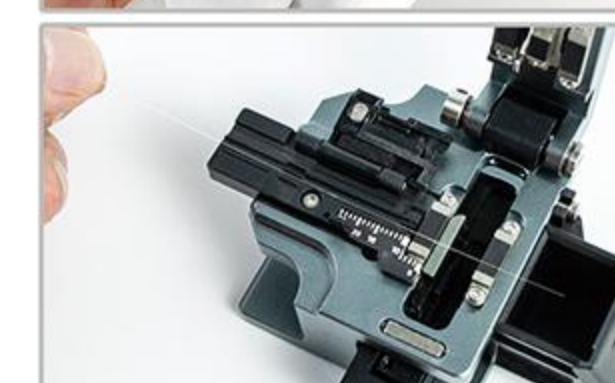

- ⊙ Make sure the stripped fiber is free of coating debris or contamination.
- ⊙ Use only 99% or better purity alcohol.

Do not allow the cleaved fiber ends to touch anything or become contaminated.

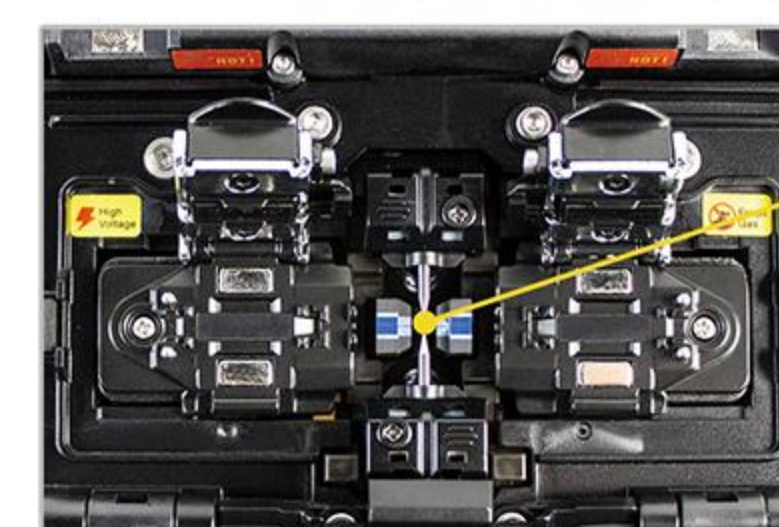

Spot of fusion

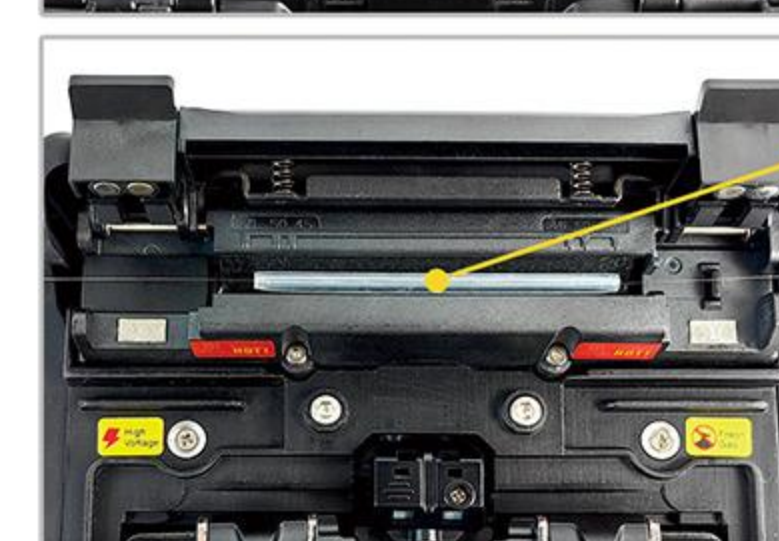

Heater oven

**Note** When splicing loss is large or When an altitude changes drastically, **【stabilizing electrodes】** and **【Arc Adjust】** must be executed before splicing.

