

Features

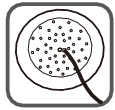

HIGH PPFD
UNIFORM LIGHT



3 OPTIONAL
SPECTRUMS



8/12/16 HOURS
AUTOMATIC TIMER



ALL YEAR
AROUND



BRIGHTNESS
ADJUSTABLE

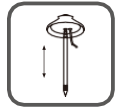

HEIGHT
ADJUSTABLE



7FT LONG CORD
WITH USB PORT



CUTE
DESIGN

Recommended potted plants

1. Herbs: Basil, Parsley, Thyme, Mint, Dill etc.
2. Flowers: Dianthus, Coreopsis, Gazania, Phlox etc.
3. Succulents: Cotyledon, Sedum, Echeveria etc.

Gardening tips

1. Ideal temperature: 65-76°F/ 16-24°C.
2. Keep the lighting panel 1"-2" above the plants to make sure they get the right amount of light.
3. 16 hours on and 8 hours off with strongest brightness is the best setting for plants grow better and faster as only when plants get enough DLI (Daily Light Integral), will they grow faster and stronger.

For more gardening tips, please visit www.i-growled.com or send an E-mail to info@i-growled.com, we will reach you within 24 hours.

Warranty

GrowLED warrants this product for free from defects in material and workmanship for 1 year since the date of purchase. This warranty will be invalid if the product has been misused, damaged by accident or in any other improper use.

For more warranty information or additional questions, please feel free to visit our official website: www.i-growled.com or contact us via E-mail: info@i-growled.com



Made in China



GrowLED®

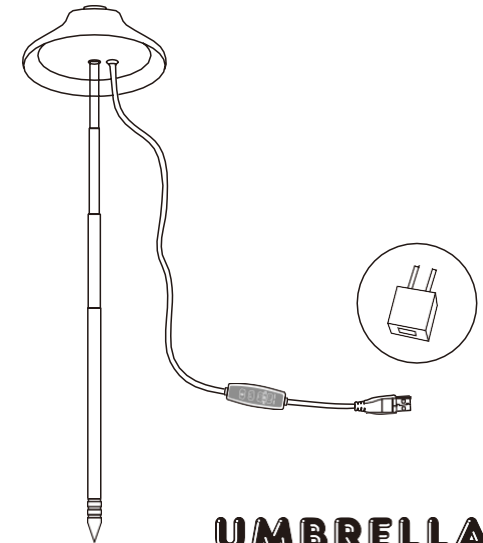

IMPORTANT SAFETY INSTRUCTIONS

Read all instructions before using this GrowLED indoor garden.

1. **WARNING- to reduce risk of burns, fire, electric shock, or injury to people.** Unplug from outlet before assembling, taking off or cleaning parts.
2. Please take proper precautions when operating the GrowLED indoor garden near or by people requiring close supervision, children included.
3. This device's safety is guaranteed only if these instructions are followed properly, therefore they should be kept for any future maintenance.
4. Never operate GrowLED indoor garden if it has a damaged cord or plug. If the cord or plug has been dropped, damaged or in water before, it may not work. If this happens, please contact customer service for assistance.
5. The cord or electrical components should not be exposed to any liquid or detergent.
6. Clean the indoor garden by using a damp, soft and clean cloth.
7. Do not use outdoors.
8. Do not allow water to touch hot LED lighting module.
9. Keep indoor garden away from any direct sources of heat (stove, furnace vents etc.).
10. Do not place or submerge cord, plug, LED lighting panel in water or other liquid to clean it.
11. Electrical wiring must be in accordance with local regulations by qualified technicians.
12. **This product is for household and residential use only.** It is not approved for commercial applications.
13. If the cord you received is damaged, it must be replaced by manufacturer in order to avoid hazard.
14. Do not use GrowLED indoor garden for other intended use.
15. Any changed or modifications to this product are not expressly approved by the party responsible for compliance could void the user's authority to operate the equipment.

Included In Package

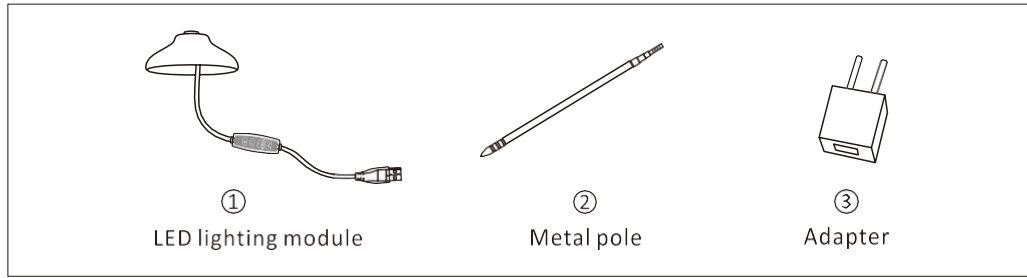

Assembly Guide

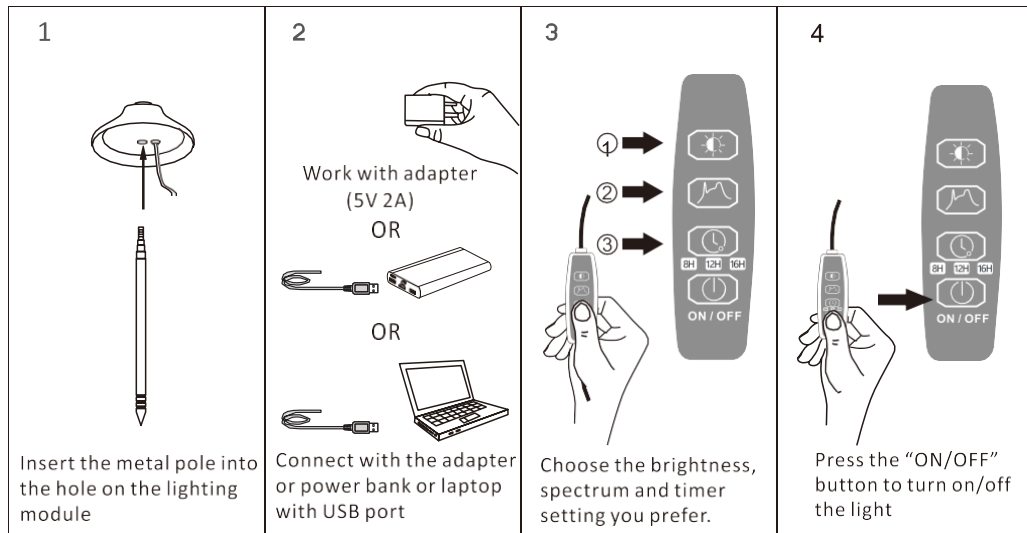

Note: The initial timer mode is 24 hours on when blue light on the controller is off, this mode can work with smart plug to set your own schedule.

Parameter

Product Series	Power	Beam angle	Operating voltage
Umbrella	5W	120°	100-240V AC
Life time	Operation temperature	IP Rate	Installed size (MIN.)
25000h	-20°C~40°C	IP20	4.33x4.33x8.66in

Dimension

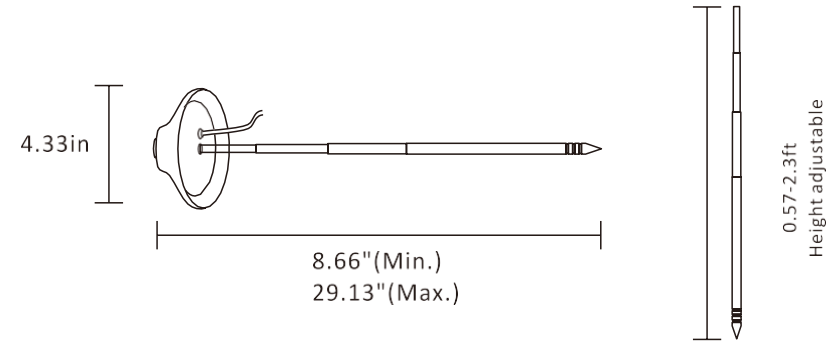

Controller

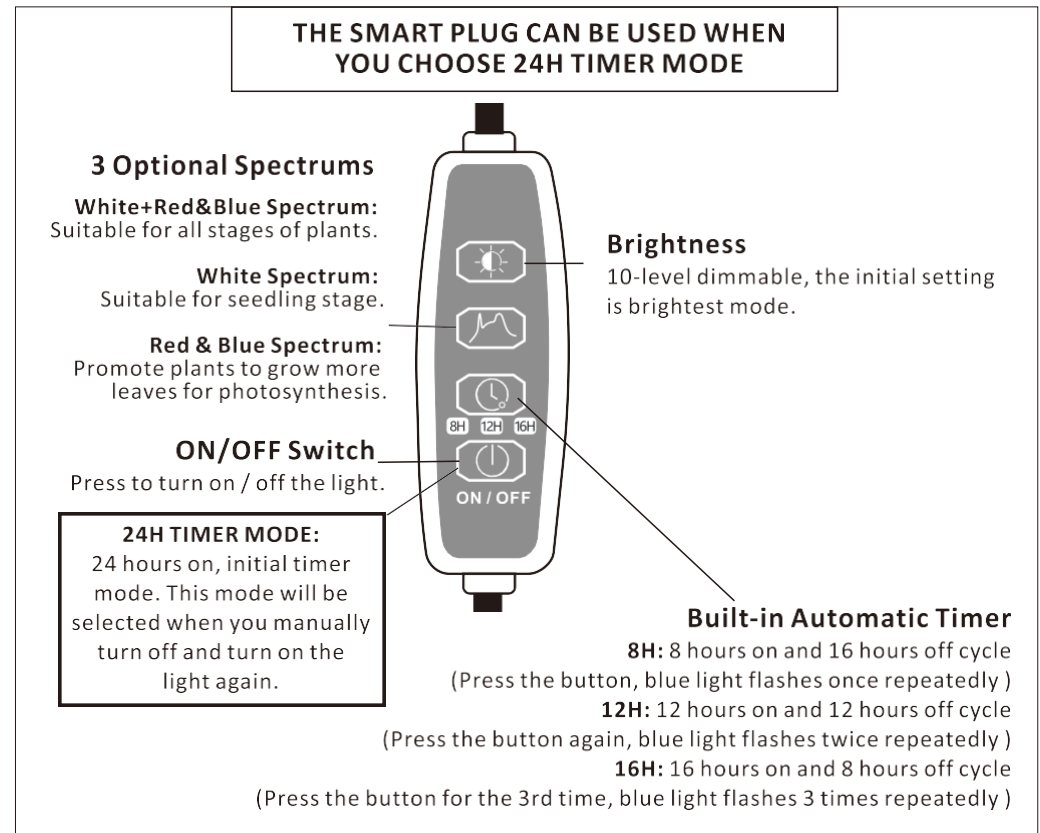

Note: 1. The blue signal light is only under "12H" icon, only the flash frequency can tell which timer mode you selected.

2. The initial setting of this light is 100% brightness with white + red & blue spectrum and 24 hours on timer mode (blue signal light on the controller is off).

3. If you manually switch off the light and switch on the light again, only the brightness and spectrum will remain the same. However, if you use the smart plug to set your own schedule, the brightness and spectrum will go back to the initial setting.