

LT-465-6W-FC

465nm/6W /Fiber Coupled Laser



■ Features

- 465nm Blue Diode Laser
- 200um,400um Selectable With Pluggable Fiber

■ Applications

- Medical & Treatment
- Industrial Marking & Cutting
- Special Light Source

■ Absolute Maximum Ratings

Parameter	Symbol	Value	Unit
Reverse Current	I_r (LD)	85	mA
Operating Temperature	T_{opr}	0 ~ +70	°C
Storage Temperature	T_{stg}	-40 ~ +85	°C
Lead soldering temperature (10 sec.)	T_{sld}	260	°C

Data sheet Rev1.0 Apr.2023

Tel: +86 136 8264 1046

E-mail: lasertree@micost-optotech.com

■ Optical and Electrical Characteristics (Tc=25°C)

Parameter	Symbol	Min	Typ	Max	Unit	Test Condition
Center Wavelength	λ_c	460	465	470	nm	Po=6W
Spectral Width (FWHM)	$\Delta\lambda$	—	2.0	—	nm	Po=6W
Optical Output Power	Po	5.4	6.0	6.6	W	Iop=3.5A
Fiber Type	—	Multi Mode Fiber			—	—
Fiber Core Diameter	—	200,400 selectable			um	—
Numerical Aperture	NA	0.22			—	—
Fiber Connector	—	SMA905,FC selectable			—	—
Working Condition	—	CW			—	—
Threshold Current	Ith	300	—	550	mA	—
Operating Current	Iop	—	3.0	3.5	A	Po=6W
Operating Voltage	Vop	8	—	10	V	Po=6W

■ Outline Dimensions

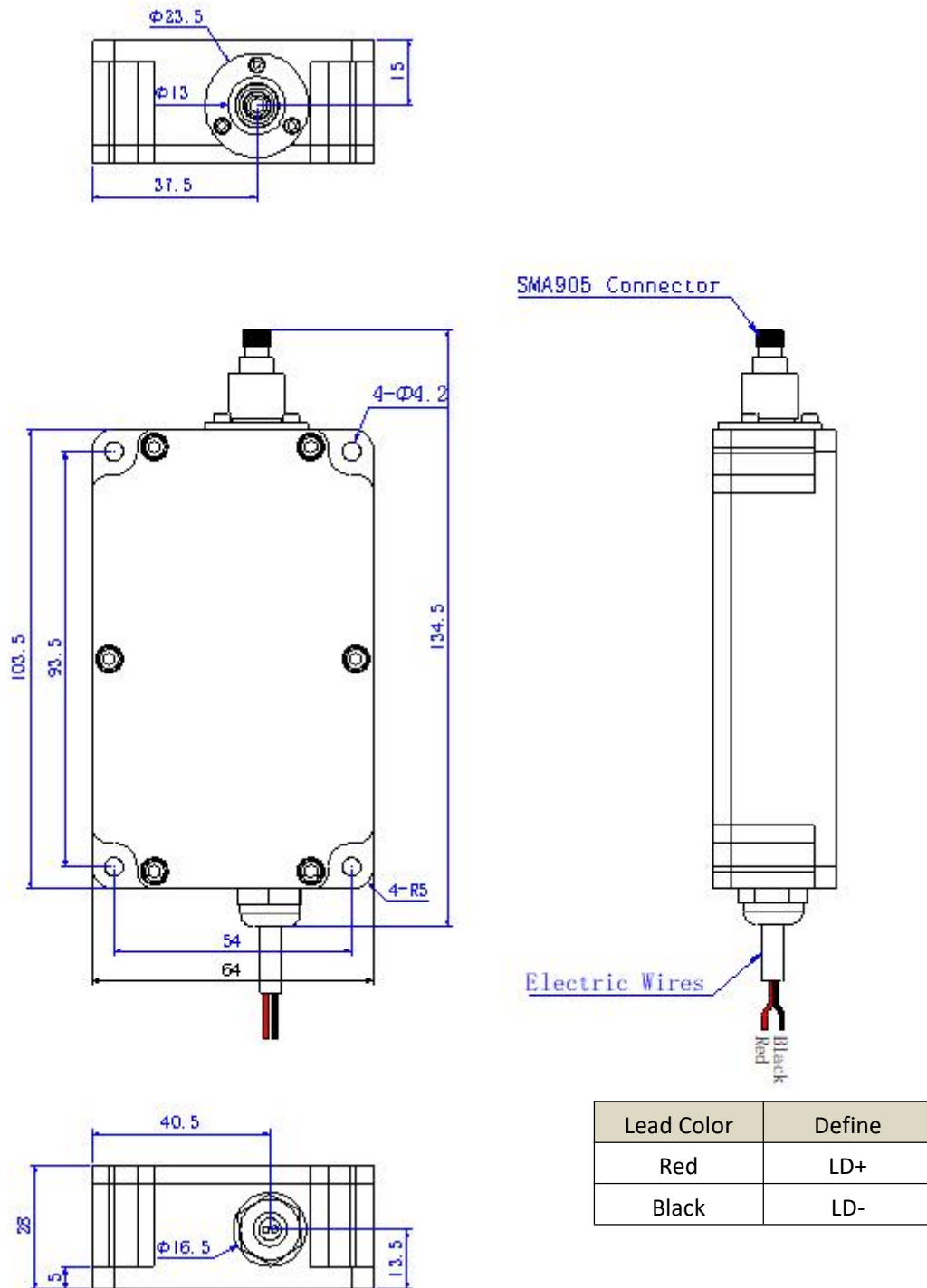

Lead Color	Define
Red	LD+
Black	LD-

■ Cautions

1. Laser light can damage the human eye and skin. Do not expose the eye and skin to any laser light directly or through optical lenses. Focused laser beam through optical instruments will increase the chance of eye hazard.
2. The laser needs a stable driver to avoid surges. The instantaneous reverse current and reverse voltage should not exceed the absolute maximum ratings, otherwise it will damage the laser diode.
3. Semiconductor lasers are sensitive to temperature, working at high temperatures will reduce the photoelectric conversion efficiency and accelerate the aging of laser diode. It should be used under adequate heat dissipation or cooling conditions.
4. The laser should be used at the rated current and rated power, the output power is too high will accelerate the aging of laser diode.
5. Semiconductor lasers are electrostatic sensitive devices, anti-static measures should be taken during storage and transportation.
6. Lasers should be stored or work in a dry, ventilated environment to prevent damage to the laser from condensation.
7. The light emitting surface (cavity surface) is the key parts of the laser diode, any handling to damage the cavity surface should be strictly prohibited. It should be ensured that the laser diode is not contaminated, and damaged in mechanical.
8. The fiber should not be bent at large angles, it should be ensured that the diameter of the bend should be more than 300 times the diameter of the fiber.

