

0809 Circulator (HP)

HR1100-S

3 Ports 850 nm High Power Optical Fiber Circulator, SM, 5 W

The HR1100-S has very low insertion loss, high return loss and high stability & reliability. It can be used for fiber laser, testing instrument and medical equipment.

FEATURES

- High Return Loss
- Low Insertion Loss
- High Stability & Reliability

USE IN

- Fiber Laser
- Testing Instrument
- Medical Equipment

MECHANICAL DRAWING

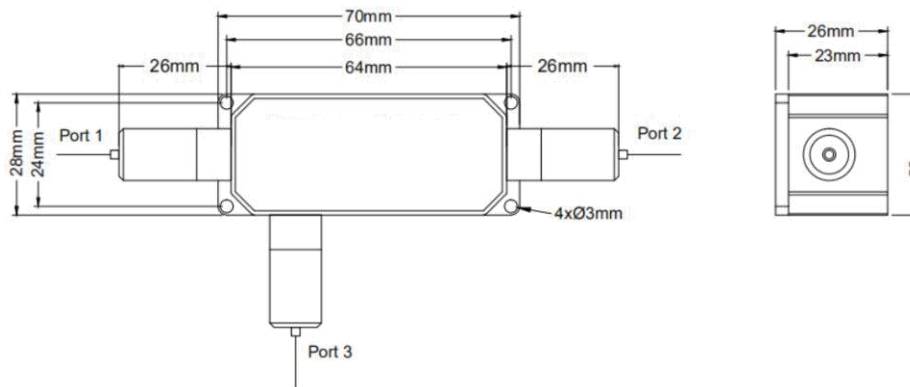

Center Wavelength	850 nm
Operating Wavelength Range	±5 nm
Isolation at 23°C	23 dB typ.@ Peak; 20 dB min.
Insertion Loss at 23°C	1.2 dB typ.; 1.5 dB max.
Polarization Dependent Loss at 23°C	0.15 dB max.
Return Loss at 23°C(Input/ Output)	45 dB min.
Cross Talk	45 dB min.
Optical Power(Including Port1 & Port2)	5 W max. or Specified
Peak Power for ns Pulse	10 kW max. or Specified
Tensile Load	5 N max.
Package Dimension	70x28x26 mm
Operating Temperature	+10°C to +50°C
Storage Temperature	0°C to +60°C