

## 0204 1xN Coupler Array

C9000-P

### 1x4 780 nm Polarization Maintaining Fiber Coupler Module

The module has low insertion loss, high return loss, high extinction ratio and high stability & reliability. It can be used for EDFA & raman amplifier, fiber sensor and fiber optical instrument and power monitoring system.

#### FEATURES

- High Return Loss
- Low Insertion Loss
- High Extinction Ratio
- High Stability & Reliability

#### USE IN

- EDFA & Raman Amplifier
- Fiber Sensor
- Fiber Optical Instrument
- Power Monitoring System

#### MECHANICAL DRAWING

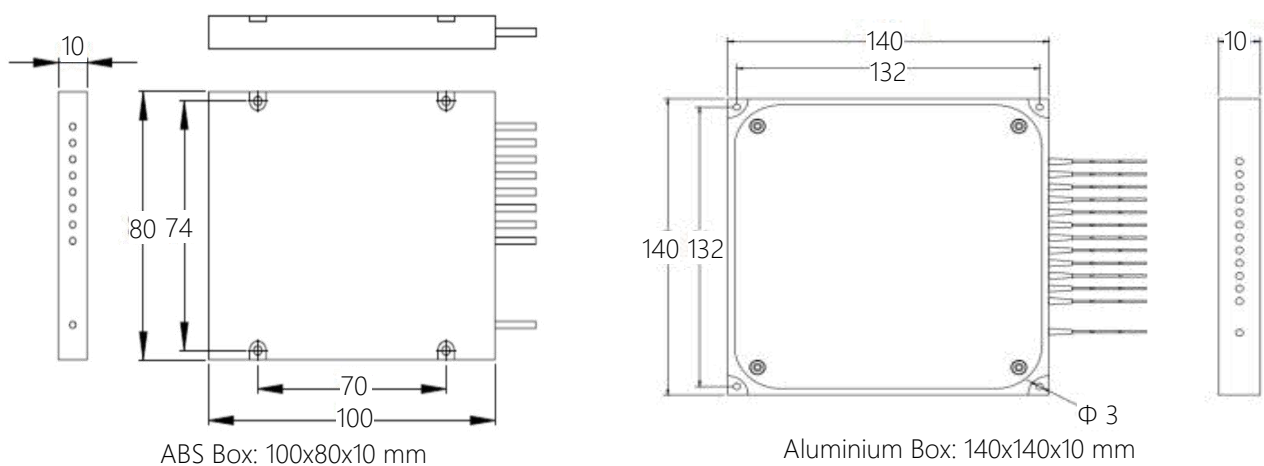

**Order notes to our customers:** The default parameters are as follows. For special needs, please contact sales.

**1) Connector FC/APC, 900 um, 1 m by default for all devices except for high power devices.**

**2) Slow axis working, fast axis blocked, connector key is aligned to slow axis by default for PM devices.**

## 0204 1xN Coupler Array

C9000-P

Center Wavelength		780 nm
Insertion Loss		8.5 dB max.
Wavelength Dependent Loss		0.8 dB max.
Uniformity		0.6 dB
Extinction Ratio	Both Axis Working	18 dB min.
	Fast Axis Blocked	22 dB min.
Return Loss		50 dB min.
Insertion Temperature Stability (-40°C to +85°C)		0.5 dB max.
Power Handling		300 mW max.
Tensile Load		5 N max.
Fiber Type		PM Panda Fiber
Dimension	ABS Box	100x80x10 mm or 120x80x10 mm
	Aluminium Box	140x140x10 mm or Customized
Operating Temperature		-5°C to +70°C
Storage Temperature		-40°C to +85°C

\* With connectors, IL is 0.3 dB higher, RL is 5 dB lower, and ER is 2 dB lower.

**Order notes to our customers:** The default parameters are as follows. For special needs, please contact sales.  
**1) Connector FC/APC, 900 um, 1 m by default for all devices except for high power devices.**  
**2) Slow axis working, fast axis blocked, connector key is aligned to slow axis by default for PM devices.**