

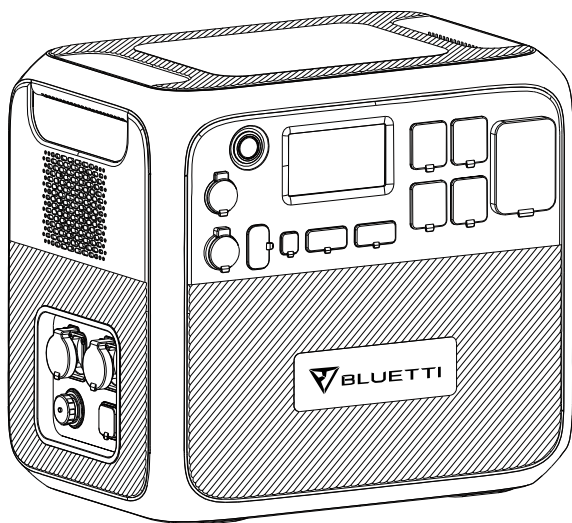

## **AC200MAX Portable Power Station**

Please read this manual before use and follow its guidance. Keep this manual for future reference.



# User Manual

Please read this manual before use and follow its guidance. Keep this manual for future reference.

# Contents

01. BRIEF INTRODUCTION .....	01
02. ABBREVIATION .....	01
03. SAFETY INSTRUCTION.....	01
04. BLUETTI APP .....	02
05. IN THE BOX .....	03
06. FEATURES .....	06
07. LET`S GET STARTED .....	07
08. TOUCHSCREEN .....	08
09. TOUCHSCREEN OPERATION .....	08
10. CHARGING .....	11
11. DISCHARGING .....	14
12. APPLICATION SCENARIO .....	14
13. EXAMPLES OF LOADS .....	14
14. AC200MAX + B230 CONNECTION .....	15
15. ESTIMATION OF OPERRTING TIME .....	17
16. TECHNICAL SPECIFICATIONS .....	17
17. TROUBLE SHOOTINGS .....	20
18. FAQ (Frequently Asked Questions) .....	21
19. DECLARATION .....	21

# 1. BRIEF INTRODUCTION

For I/O capability, the AC200MAX features higher continuous output power at 2,200W from its pure sine wave inverter, a 100W PD3.0 USB-C port, an upgraded MPPT controller which now handles up to 900W of solar input and a built-in 30A NEMA TT-30 outlet designed especially for the RV crowds. And most importantly of all after feedback and listening to our customers, finally, the BLUETTI AC200MAX supports Bluetooth connection and can be controlled by the new BLUETTI Smartphone App (iOS & Android). And it too, also supports expandable battery packs.

The AC200MAX supports up to two additional battery packs, using either the BLUETTI B230 or B300. With two BLUETTI B300 you can easily expand your AC200MAX to a massive 8192Wh of capacity to run all of your essential needs at home or on-the-go for hours, days, or even more than a week!

# 2. ABBREVIATION

- BMS: Battery Management System
- MPPT: Maximum Power Point Tracking
- SOC: State of Charge
- AC: Alternating Current
- DC: Direct Current
- PV: Solar Panel(s) Charging (Photovoltaic)
- Grid: Home Power Supplied by Utility
- T500: 500W Adapter
- DOD: Depth of Discharge
- ECO: A power-saving setting for the AC200MAX. While it's on, the AC output ports will be automatically turned off if the load on it is less than 50W over a span of 4 hours.

# 3. SAFETY INSTRUCTION

- DO NOT place the power station near heat sources. It is prohibited to place the equipment in an environment with flammable, explosive gas, or smoke. It is also prohibited to operate the equipment in this environment.
- DO NOT attempt to replace the internal battery or any other component of

the equipment by anyone other than authorized personnel.

- DO NOT operate in wet conditions. If the equipment becomes wet, please let the unit dry completely before using.
- Please ensure proper ventilation while in use and do not obstruct fan openings. Inadequate ventilation may cause permanent damage to the equipment.
- DO NOT move the unit while operating as vibrations and sudden impacts may lead to poor connections to the hardware inside.
- Warning: DO NOT insert foreign objects into any ports of the AC200MAX (both AC & DC & ventilation holes). The power station generates the same potentially lethal AC power as a household wall outlet. Please use it carefully and keep children away from it.
- In the case of fire, only a dry powder fire extinguisher is suitable for the product.
- For safety purposes, please use only the original charger and cables designed for the equipment. We are not liable for damage caused by third-party equipment and may render your warranty invalid.

## 4. BLUETTI APP

Search for “BLUETTI” in the App Store (for iOS devices) or Google Play (for Android devices) to download the BLUETTI App to remotely control your AC200MAX.

The AC200MAX can be controlled via Bluetooth. In order to access the AC200MAX, please launch the BLUETTI App once downloaded and installed, and tap the “Bluetooth CONNECT” icon to register your BLUETTI AC200MAX.

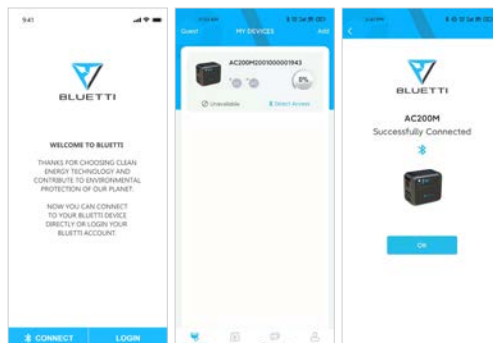



The basic information of your AC200MAX can be viewed after the unit has connected with the App successfully. Press the “gear icon” to customize the current working mode and parameters of your AC200MAX under “Settings”.









NOTE: Please keep your phone within 5m/16.4ft of the AC200MAX in order to reduce connectivity issues during update.

## 5.IN THE BOX



### Standard Accessories

No.	Category	Quantity
1	 AC200MAX Power Station	1
2	 T500 500W Adapter For AC charging	1

3	 <p>PV Charging Cable (XT90 - MC4) For solar charging, up to 15A,900W.</p>	1
4	 <p>Car Charging Cable (XT90 - Cigarette Lighter Port) Charge AC200MAX by car.</p>	1
5	 <p>Multi-functional Aviation Cable (XT90 - Aviation) Expand the charging methods via PV input port.</p>	1
6	 <p>User Manual Please read the manual before use and follow its guidance, keep this manual for future reference.</p>	1
7	 <p>Warranty Card Please keep this Warranty Card properly.</p>	1

8	 Certificate of QC PASS	1
---	---	---

Optional Accessories

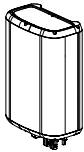
No.	Category	Type
9	 Lead-acid Battery Charging Clamp Charging AC200MAX through lead-acid battery only. DO NOT charge the lead-acid battery via this cable.	Optional Input Cable
10	 Multi-functional Input Cable (XT90 - DC7909) Expand the charging methods via AC input port.	
11	 12V/30A Output Bundle (Aviation - XT60, XT60 - SPC45) Perfect for RV.	Optional Output Accessories
12	 D300S PV Step Down Module Step down the voltage of solar panels(especially rigid panels) to adapt to AC200MAX solar input limit range.	Optional Accessories

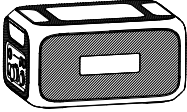
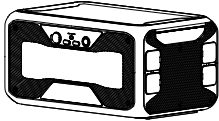

13	 <p><b>B230 Battery Module</b> Add extra 2048Wh capacity, up to 2xB230 can be connected to AC200MAX.</p>	Optional Accessories
14	 <p><b>B300 Battery Module</b> Add extra 3072Wh capacity, up to 2xB300 can be connected to AC200MAX.</p>	Optional Accessories

## 6.FEATURES

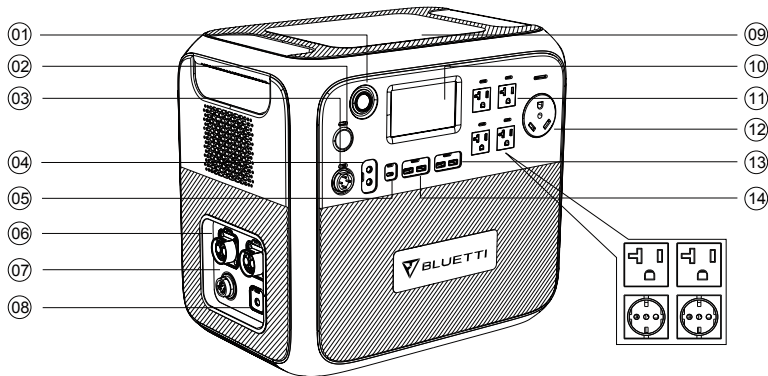

**01 Power Button**

Lone/Short press to turn ON/OFF the AC200MAX.

**02 DC 12V/30A output**

Special 30A output port can be adapted to appliances widely,perfect for RV.

**03 DC 12V/10A cigarette lighter port**

Output port for devices with corresponding plug such as vehicle-use vacuum,refrigerator.

**04 DC 5521 12V/10A output x 2pcs**

Traditional ports for routers/cameras, old laptop etc.

**05 USB-C 100W output**

Can be used via USB-C to USB-C cable to charge most devices in the market such as Pixel Phone, Macbook Pro at 100W Max.

**06 Battery extension port x 2pcs**

The port to connect AC200MAX with B230 or B300 battery pack.

**07 DC input port**

Can be connected to solar panels, or achieving car charging, lead-acid battery, extra T500 adapter by extra cables.

**08 AC input port**

Charging via T500 adapter.

**09 Wireless charging 15W x 2pcs**

Place your phone(if wireless charging supported) on the top of the AC200Max vertically, and turn on the DC in mainpage on screen.

**10 Touchable interaction LCD display**

Can be pressed/tapped to control the unit by nails.

**11 US AC output x 5 pcs(EU/UK AC output x 4pcs)**

Standard AC receptacle: wildly used in 100-120V areas, generates the almost same AC power as a household wall outlet. High-voltage area uses special sockets.

**12 US AC TT-30P**

NEMA TT-30: connector which is the 120V/30 A recreational vehicle standard, also known as RV 30. The TT-30R receptacle is commonly available in nearly all RV parks in the United States and Canada.

**13 USB-A 5V/3A output x 2pcs**

Classic USB-A ports.

**14 USB-A 18W output x 2pcs**

Quick charge USB-A ports.

## 7.LET`S GET STARTED

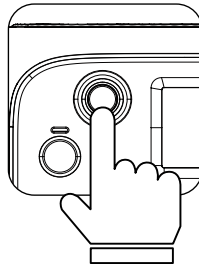

- (1) Startup: short press the power button to turn it on, the indicator light is on.
- (2) Shutdown: press and hold the power button for more than 1 seconds, and the indicator light will be off.

The LED indicator lamp status	
BMS Over-current or short circuit protection	Turn off after the indicator light flashes
BMS Startup timeout	The indicator light flashes and does not shut down
Normal startup	The indicator light on
Normal shutdown	The indicator light off

(3) DC power switch and AC power switch are integrated into the interaction LCD screen(Figure 1), press “DC ON/OFF” button and “AC ON/OFF” button on the screen to turn on/off the DC /AC output.

## 8.TOUCHSCREEN

Interaction LCD screen(Information Vision) supports below functions:

- (1) Real-time display of voltage, current, power, temperature and state of charge and discharge.
- (2) The user can adjust the output voltage, frequency, charging mode, power consumption mode, and time information according to the setting column.
- (3) Support energy-saving, and enable Super ECO mode to save more than 30% of useless energy loss.
- (4) Support users to view fault information, historical fault information, software version independently.

## 9.TOUCHSCREEN OPERATION

### Warm tip:

- The touchable LCD screen is a resistance screen. we recommend tapping the touch the touchscreen by fingernail lightly until it "beeps".

● To maximize the lifespan of the LCD screen, please avoid direct sunlight on it.

(1) When press the power button, the mainpage will display as Figure 1.

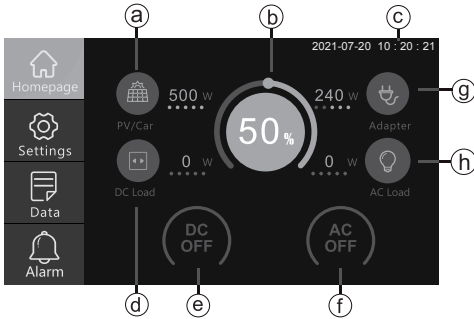

(Mainpage)

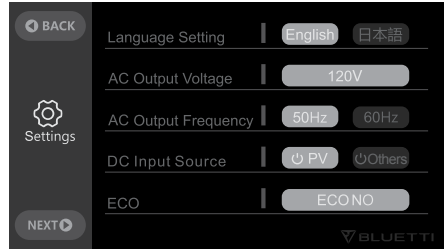

(Figure 1)

- a. PV/Car charging Info
- b. BMS Info
- c. Date/Time
- d. DC load Info

- e. DC ON/OFF Switch
- f. AC ON/OFF Switch
- g. Adapter charging Info
- h. AC load Info

(2) Tap the settings icon in the main interface (Figure 2) to enter the setting interface as follows (Figure 3) :

Warm tip: Please enter the setting interface to set the date and time according to the local time zone, and check the output voltage, frequency and other parameters for the first time startup.

Voltage and Frequency Reference:

- JP: 100V/50Hz
- US: 120V/60Hz
- EU: 230V/50Hz
- UK: 230V/50Hz

DC Input Source: Select the right method you choose to charge AC200MAX.

ECO Mode: While it`s on, the AC output ports will be automatically turned off if the load on it is less than 50W over 4 hours.

Press “Next” icon to enter date setting as (Figure 3):

Backlight and Sleep time: set the proper value as your need for power saving.

Date and time: 2000-00-00, 00 : 00 : 00, tap the number to set it right.

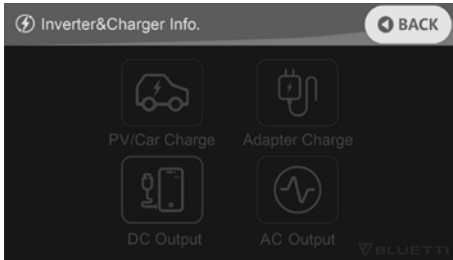

(Figure 2)

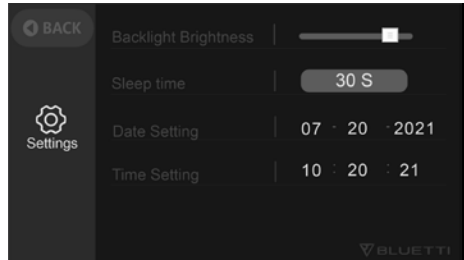

(Figure 3)

(3)Return to the mainpage, tap the “Data” icon to enter the Data page (Figure 4) :

- Tap the “Product Info” icon, you can view the product model, software version, BMS version etc;
- Tap the “Inverter & Charger Info” icon, you can view input and output information, which can also be accessed directly from the shortcut icon on the mainpage;
- Tap the “BMS Maintenance” icon to view the status of battery, and it can also be accessed directly from the shortcut icon in the mainpage;
- Tap the “Fault History” icon, all the fault information generated by the AC200MAX in daily use.

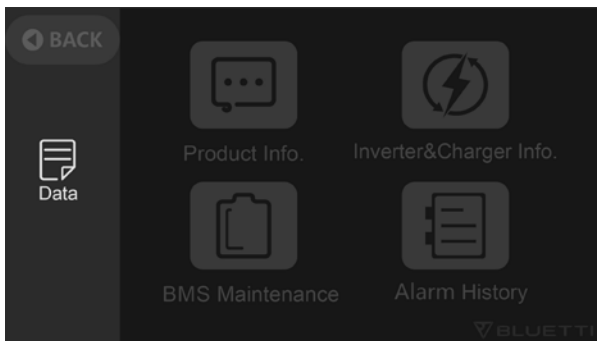

(Figure 4)

(4) Tap Alarm Icon (mainpage) to view the current error information: the fault indicator will display orange if there is a fault occurs.

# 10.CHARGING

## (1) From AC wall outlet

- Turn AC200Max ON and connect the plug of adapter to the wall outlet, the other side to AC input port. Charging will automatically stop when it reaches 100%(4.6-5.1Hrs).

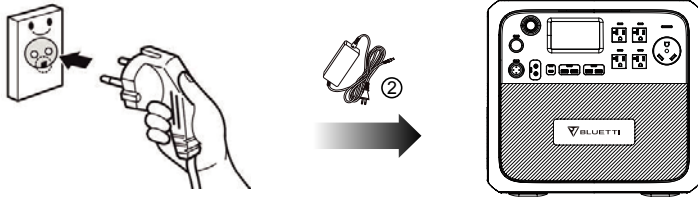

## (2) From the solar panels

- Connect the solar panels(in series or parallel) with Open Circuit Voltage range 10V-145V.
- Connect the solar panel to AC200Max via solar charging cable. (Standard Accessories 5 to Accessories 3)
- Plug and play charging: AC200Max will be activated when solar charging system built up successfully.
- Max input current of the solar charging: 15.2A  $\pm$  0.3.

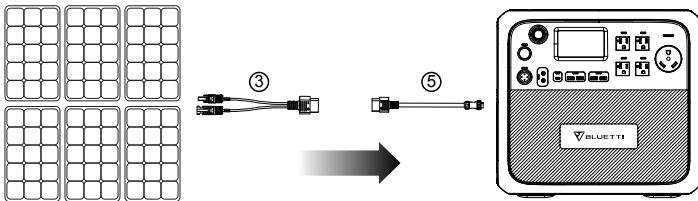

## (3) Car Charging

- Press the power button and connect it to the cigarette lighter port through the car charging cable.
- Enter the setting interface as shown in (Figure2) through the display screen to set DC input source to car mode; The product can be charged with 8.2A maximum current.

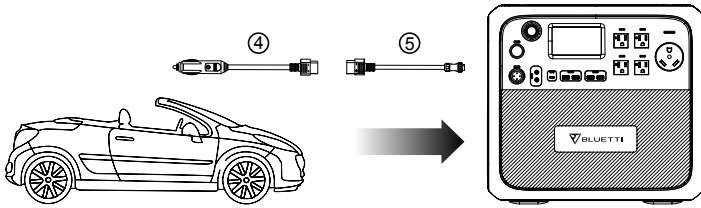

(4) Generator Charging(gasoline, propane or diesel)

- Connect the AC adapter input to the generator and the output port to the AC charging port of the machine.
- Press the power button, the product will be charged, the charging will automatically stop when it reaches 100%.

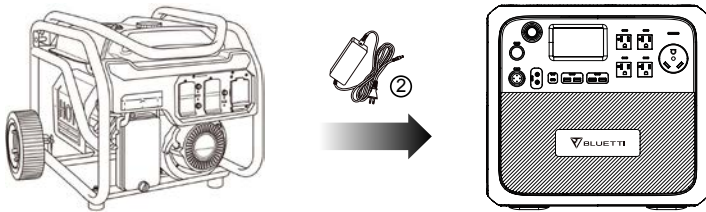

(5) Lead-acid Battery Charging

- Connect to the positive and negative poles of the battery through the Charging Clamp (Accessories 9)

Note: pay attention to distinguish the positive and negative poles of the battery, the red side indicates positive pole.

- Enter the setting interface in (Figure 1) through the screen to set DC input source to “car mode” to achieve 12V/24V car charging mode, with the maximum current of 8.2A.

Note: DO NOT charge the battery through this accessory.

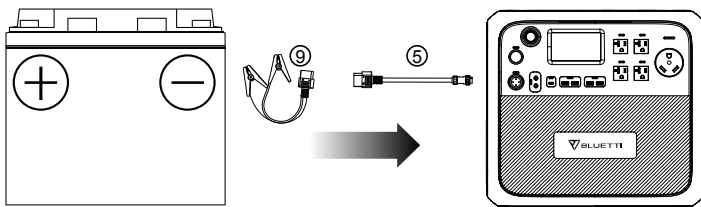

(6) Dual Charging

- Set the DC input source to PV to achieve AC + PV Dual Charging
- Set the DC input source to others to achieve AC + T500/Lead-Acid Battery Charging.

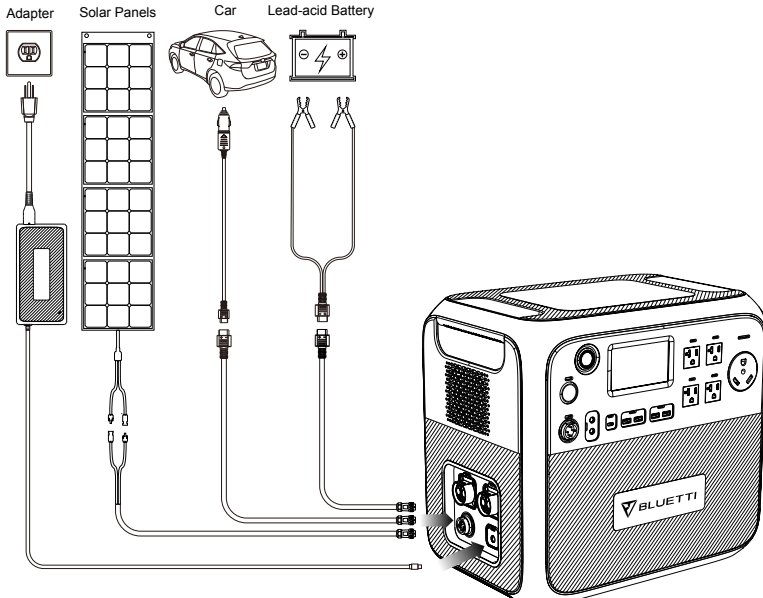
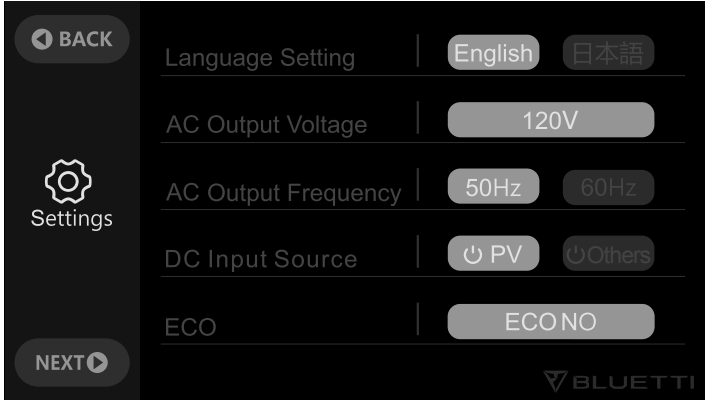

(AC200MAX Dual Charging System)



# 11.DISCHARGING

- (1) Turn on 12V/30A, 12V/10A, cigarette lighter port, USB and USB-C output: press the power button, then enter the main interface through the touch screen, tap the DC ON/OFF button and confirm, Turn off these output, and also tap the DC ON/OFF button and confirm.
- (2) Turn on AC output: press the power button, then enter the mainpage through the touchscreen, tap the AC ON/ OFF button and confirm. Turn off these AC output ports, and also tap the AC ON/ OFF button and confirm.

# 12.APPLICATION SCENARIO

- (1) Outdoor  
Car equipment: car fridge, car vacuum cleaner and other car equipment;  
Camping equipment: garden electric tools (power tools such as blowers, lawn mowers, electric drills, electric saws), BBQ grills, LED lights, etc.
- (2) Indoor  
Refrigerator, kitchen devices such as kettle, toaster, blender, coffee maker, rice cooker, laptops, phones, lighting, etc.

# 13.EXAMPLES OF LOADS

- (1) 12V/30A, 12V/10A, cigarette lighter port, USB-A and USB-C output port are suitable for most products in the market, but some products may trigger overcurrent protection if there is a large current impact at the moment of starting.
- (2) The power of electrical products used for AC output should be less than 2200W. According to the different electrical products, when the rated power is less than 2200W, some air conditioners, motors and other devices that need instantaneous high current when starting may trigger overcurrent when the ratio of peak value of rated current exceeds 3:1. At this time, we recommend that you select the electrical appliances with lower power rate.
- (3) When the output is overload, over-current or short circuit, the product will turn off the corresponding output port, and then it will automatically start twice (at an interval of 20s). If there is still an overload, over-current or short circuit alarm, the output port will be locked, and need to be manually troubleshooting and then restart. If the output stops repeatedly after restart,

please stop using it immediately (only after troubleshooting) or contact the vendor or maintenance agent for help.

(4) When the battery power is discharged to 0%, the DC and AC output will automatically turn off. Only when the battery power is charged to more than 5%, the DC and AC output can be turned on, which is to protect the battery and enhance its cycle life.

(5) This machine supports charging and discharging simultaneously.

## 14.AC200MAX + B230 CONNECTION

### Capacity Extended

- AC200MAX can extend the capacity by 1-2 B230 battery pack to 4096-6144Wh.
- AC200MAX can extend the capacity by 1-2 B300 battery pack to 5120-8192Wh.

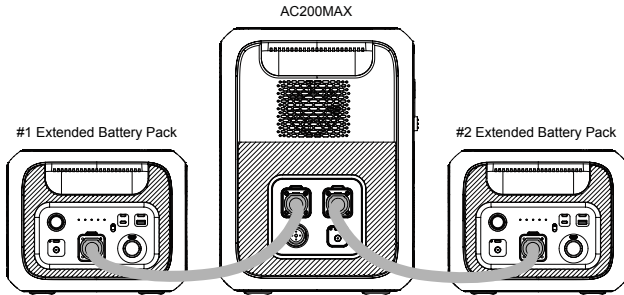

#### ● Battery Extension Instruction

Hotswap extended battery pack B230/B300 designed to achieve capacity backup with easy plug-on P090A cabel.

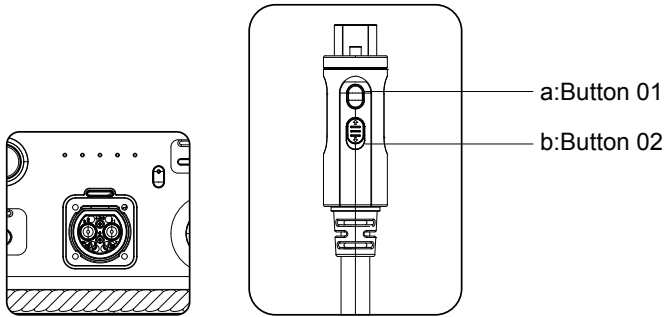

a:press to turn ON/OFF the extended battery function.  
 b:switch to LOCK/UNLOCK the cable with AC200MAX.

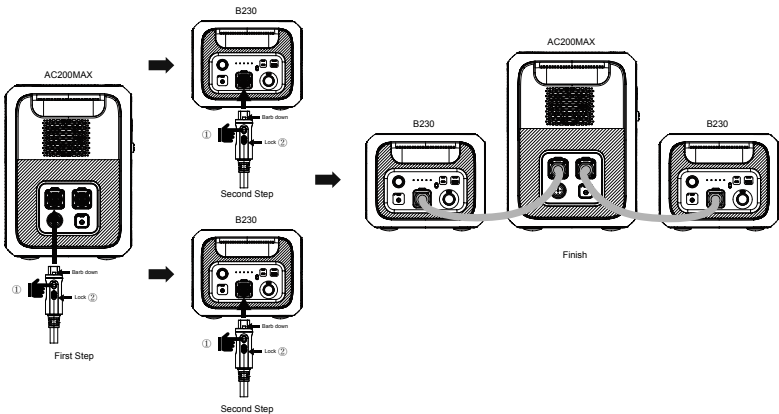
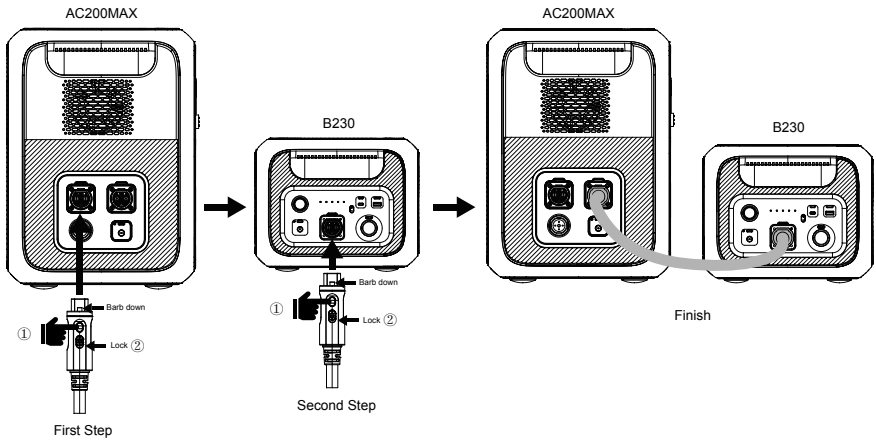

AC200Max Capacity Extended Mode

## 15. ESTIMATION OF OPERATING TIME

Smartphone 175-200Times 10W	LED Light Bulb Around 75-85hrs 20W	Television Around 20-22hrs 75W
Electronic Tools Around 19-20hrs 80W	Refrigerator Around 17-19hrs 90W	Slow Cooker Around 8-9hrs 200W

$2048Wh \times DOD \times \eta \div (\text{load } W) = \text{charging time (unit : h)}$

Note : DOD is the battery discharge depth,  $\eta$  is the local inverter efficiency,

DOD=90%,  $\eta$  =88%.

## 16. TECHNICAL SPECIFICATIONS

<b>Model No.</b>	<b>AC200MAX</b>	
Net Weight	28.1kg (61.9lbs)	
Dimensions	420*280*386.5mm (16.5*11.0*15.2in)	
Charge Temperature	0-40°C (32-104 °F )	
Discharge Temperature	-20-40°C (-4-104 °F )	
Working Environment Humidity	10-90%	
Capacity	2048Wh (40Ah)	
Battery Type	LiFePO4	
Standard Battery Voltage	51.2VDC	
<b>Category</b>	<b>Rated</b>	<b>Note</b>
<b>AC Output</b>		

Power of Output	100V	2000W	JP
	110V	2200W	
	120V	2200W	US
	220-240V	2200W	UK,EU
Over-load	100V	2000W<load<2500W,2min ; 2500W<load,8~10S	Error Range : $\pm 30W$ ; Clear the alarm history and reboot the unit.
	110V	2200W<load<2750W,2min ; 2750W<load,8~10S	
	120V		
	220-240V		
Surge	4800W		100ms
Frequency	50/60Hz $\pm 0.5Hz$ Default @60Hz		Frequency can be tweaked to 50 or 60Hz
Inverter Efficiency	88%		/
Short-circuit Protection	Yes		/
Over-temperature Protection	80°C $\pm 2$		Recover Temp: 75°C $\pm 2$ (for hardware)
AC & DC will be turned off when SOC reaches 0%			
<b>DC Output</b>			
Cigarette Lighter Port *1	Voltage	13.5V	Share 10A current with *2 DC5521 ports
	Current	10A	
	Over-load Power	145W	2s, Turn off output function
	Short-circuit Protection	Yes	Turn Off all DC output ports.
DC5521 *2	Voltage	13.5V	Share 10A current with *2 DC5521 ports
	Current	10A	
	Over-load Power	145W	2s, Turn off output function
	Short-circuit Protection	Yes	Turn Off all DC output ports.

RV *1	Voltage	13.5V	/
	Current	30A	
	Over-load Power	400W	2s, Turn off output function
	Short-circuit Protection	Yes	Turn Off all DC output ports.

**Note:**

a: 30A Max. current for all DC output port

b: The cigarette lighter port will be shut off once overload.

c: 12V/30A port will be shut off when overload again.

USB-A *2	Voltage	5.15V	3A for both
	Current	3.0A	
	Short-circuit Protection	Yes	Recover automatically

USB-A Quick *2	Voltage	5-12VDC	Support QC3.0
	Current	3A * 2	18W * 2, MAX
	Short-circuit Protection	Yes	At 3.3A ± 0.1 ; Automatically recover after disconnecting the load

Type-C *1	Standard	Support PD3.0(Max.100W)	
	Specs	5VDC,3A,15W Total	
	Short-circuit Protection	Yes	At 5-15V,3.4A ± 0.2 / 12V,5.5A ± 0.2

Wireless Charging *2	Standard	Support QI protocol	Please place the wireless device vertically.
	Power	5/7.5/10/15W * 2	

**Solar Input**

Power of Input	900W	/
Over-voltage Protection	145VDC	/
MPPT Voltage Range	10-145VDC	
Current	15A	Over-current: 15.2A ± 0.3

MPPT Quantity	1/1	/
T500 Adapter charging (On PV input port)	500W	/
	8.2A	/
Car Charging	11.5-14.5V	Set DC input source on screen : Others 12V Lead-acid Battery: 11.5V ± 0.2V ; 24V Lead-acid Battery: 23V ± 0.2V
	23-29V	
	7.9-8.4A	
Note : PV Input, Car Charging and additional T500 shares the same Aviation Port.		
<b>T500 AC Adapter</b>		
Input Voltage	100-240VAC	/
Voltage Range	58.8V	/
Max. Charging Power	500W	/
Note:		
a: AC200MAX can be automatically activated(turn the unit ON without pressing the power button from POWER OFF) via solar power. Please unplug the DC input cable if you want to enable the auto activation.		
b: AC200MAX is not able to activate via adapter.		
c: Simultaneous charging&discharging supported.		
<b>BLUETTI APP(Bluetooth)</b>		
Firmware Update	5m/16.4ft	/
Wireless Connect	10m/32.8ft	/

## 17.TROUBLE SHOOTINGS

Error Code	Description
001	PV Over Voltage
004	DC Output Short Circuit
005	Adapter Over Voltage
006	Adapter Low Voltage
007	Adapter Relay Error
008	Adapter Over Current

010	USB/TYPE-C/PD Over Current
011	12V/10A Over Current
012	12V/30A Over Current
014	DC Start Failure
015	DC Output Relay Error
016	Bus Start Failure
017	Inverter Start Failure
018	Bus Low Voltage
019	Bus High Voltage
020	Inverter Low Voltage
021	Inverter High Voltage
022	Inverter Low Frequency
023	Inverter High Frequency
025	Battery High Voltage
026	Battery Low Voltage
027	Battery Unconnected
028	Fan Error
029	NTC Error
030	Calibration Error
031	Inverter Over Load
032	Inverter Short Circuit
033	DSP Communication Error
034	BMS Communication Error
035	EEPROM Read_write Error
036	Parameters of Control Module Error
041	BMS Temperature Error
042	BMS Over Voltage
043	BMS Low Voltage
044	BMS Over Current
045	BMS Pre-charge Failure
046	BMS Output Short Circuit
051	AC Output Locked
053	USB/TYPE-C/PD Locked
054	12V10A Locked
055	12V30A Locked

## 18. FAQ (Frequently Asked Questions)

- How to claim the warranty?

Please place your after-sale requirement as the warranty card written to the



vendor where you order the product.

- Can the unit be upgraded?

When AC200MAX connected with BLUETTI App via bluetooth, the firmware including ARM, DSP, IoT and BMS can be upgraded online through OTA.

- Can it be charged and discharged at the same time?

Yes.

- How to store the AC200Max ?

We recommend charging the unit to 60-80% SOC every 3 months to extend the battery life.

## **19. DECLARATION**

- Some changes may occur without notice such as external appearance or specifications due to availability of material supplies or hardware improvements of the product and APP over time.

- Our company shall not be liable for any damage caused by force majeure such as fires, typhoons, floods, earthquakes or the user's intentional negligence, misuse or other abnormal conditions.

- No compensation for damages shall be made for utilizing non-standard adapters and accessories.

- This unit is not suitable for use on the relevant equipment or machines involving:

Personal safety, such as atomic energy devices, Hi-Fi player devices, emergency medical devices, etc., or any equipment or machines that require extremely highly reliable power sources. We are not responsible for accidents, fires, wrongful or negligent actions caused by such equipment or machines which results in damage.

P/N:17.0303.0380-00A0