

4K HDMI+USB KVM Extender over IP / Fiber

Operation Instructions



Table of Contents

1.	Introduction.....	3
2.	Features.....	3
3.	Package Contents.....	3
4.	Specifications.....	4
5.	Hardware Description.....	5
5.1	Transmitter.....	5
5.2	Receiver.....	6
5.3	Descriptions Buttons.....	7
6.	Installation.....	11
6.1	Device Connection.....	11
6.2	IP Configuration.....	14
7.	Web User Interface Configuration.....	17
7.1	System.....	17
7.1.1	Version Information.....	17
7.1.2	Update Firmware.....	18
7.1.3	Utilities.....	19
7.1.4	Statistics.....	20
7.2	Video Wall.....	21
7.2.1	Basic Setup.....	21
7.2.2	Advanced Setup.....	25
7.3	Network.....	29
7.3.1	IP Setup.....	29
7.3.2	Casting Mode.....	30
7.4	Functions.....	31
7.4.1	IP Setup.....	32
7.4.2	Casting Mode.....	33
7.4.3	Serial over IP.....	34
8.	Broadcast Configuration Example.....	35
8.1	Multicast.....	35
8.2	Unicast.....	35
8.3	Matrix.....	35
8.4	Video Wall.....	36
8.4.1	Basic Setup.....	36
8.4.2	Advanced Setup.....	37
	Warranty.....	40

1. INTRODUCTION

The 4K HDMI & USB over IP Extender is a solution for audio, video and USB signal extension via Local Area Network (LAN). It can be used as audio, video and KVM extender over IP and applied to point to point, point to multi-point, multi-point to multi-point and screen wall broadcast system controlled by USB, RS232, IR and configured the 4K HDMI & USB over IP Extender by web browser. An easy installation system built up with Giga Ethernet switch which has IGMP function and CATx cable for extension or broadcast.

2. FEATURES

- 4K UHD HDMI over IP extension
- USB 2.0 over IP extension
- RS232 bi-directional extension and RS232 control
- 4 bits switch for 16 stream channel selection
- Support Dolby True HD, DTS-HD Master Audio
- Support two way Wide Band IR extension (38khz-56khz)
- Transmit over single Cat5e/6 cable up to 120m
- Transmitter over Fiber Optical cable up to 60km (Single Mode)
- Networking environment under Giga Ethernet switch and CAT5e cable
- Point to point extension, Unicast, Multicast and Video Wall system (Max 8x16)
- Output video rotation
- Output video partial enlargement
- HDCP 1.4 compliant

3. PACKAGE CONTENTS

- 1). Main Unit. HDMI Extender (Transmitter & Receiver)
- 2). Power adapter DC 5V x2PCS
- 3). 2xIR TX cables, 2x IR RX cables
- 4). 2x Phoenix plugs for RS232 cable termination
- 5). 4x screws
- 6). Rear bracket x2
- 7). Operating Instruction manual

4. SPECIFICATION

Performance	
Protocol	TCP, UDP, RTSP, RTP, DHCP, IGMP, Multicast, IPV4
Support Video format	4K@30HZ, 1080P/1080i/720P/576P/576i/480P/480i
Support Audio format	Stereo 192Kbps
HDCP	Compliant
IR Frequency	38 -56 KHZ
RS232 Baud rate	Default 115200bps, total 8 kinds optional
IP setting &Group ID setting	
Default IP	Automatic allocation
Group ID	Group 00 ~ group 16
Request for Switch/Router	Support IGMP, support DHCP
Connectors on Transmitter	
Input	1xHDMI Female port, 1xUSB B type
Output	1x RJ45 output, 1x Fiber output
RS232	Phoenix RS232 port
IR	1x IR TX port; 1x IR RX port Support 38K-56KHz
Connectors on Receiver	
Input	1xRJ45 input, 1x Fiber input
Output	1x HDMI Female port, 2x USB A type
RS232	Phoenix RS232 port
IR	1x IR TX port; 1x IR RX port Support 38K-56KHz
Environmental & Power Requirements	
Operating temperature	-5 to +35 °C (+23 to +95°F)
Operating Humidity Range	5 to 90%RH (No Condensation)
Power supply	DC 5V
Power consumption	Max 3 watt
Physical	
Dimension	TX: 160x103.2x30mm ; RX: 160x103.2x30mm
Net Weight	TX: 472.8G ; RX:472.3G

Note1: Specifications are subject to change without notice. Mass and dimensions are approximate.

Note2: **When transmit over Fiber, 4Kx2K requires 3.125G module.**

5. HARDWARE DESCRIPTION

5.1 Transmitter

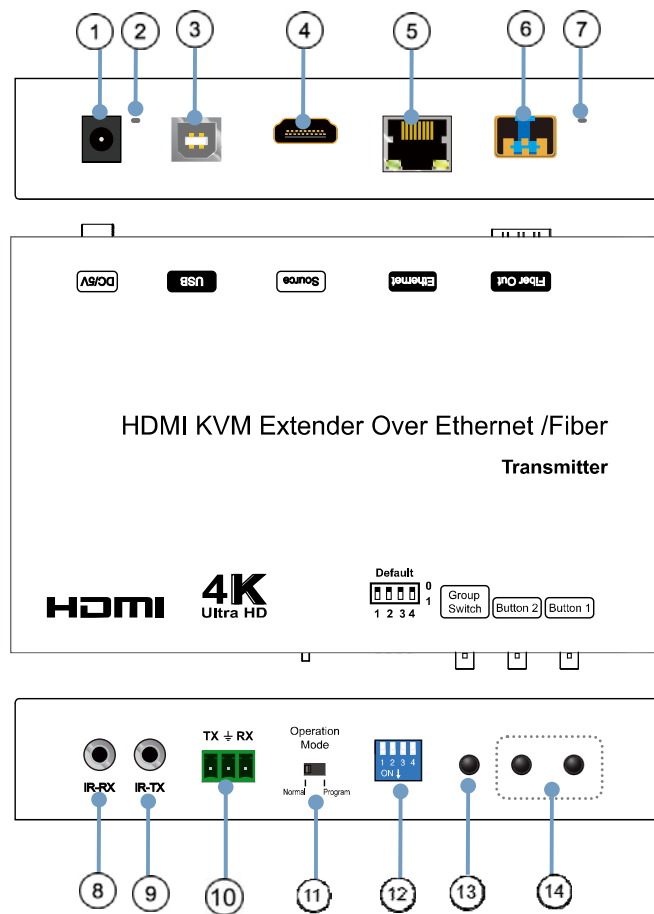

- | | | |
|---|-----------------------------------|---------------------------|
| 1) Power input port | 2) Power input indicator 1 | 3) USB |
| 4) HDMI input | 5) Ethernet port | 6) Fiber Out |
| 7) Indicator of status 2 | 8) IR-RX port | 9) IR-TX port |
| 10) RS232 port | | |
| 11) Normal: For serial over IP;
Program: For serial control or getting the debug information | | |
| 12) 4 bit Dip switch | 13) Group Switch 3 | 14) Button 1 & 2 4 |

1 A. Green LED: Link LED, when the connection has established over Cat5e/6 cable or Fiber cable, the Green LED will illuminate.

B. Yellow LED: When the yellow LED is blinking, it indicates the connection has been established over Cat5e/6 cable.

2 When the green LED illuminates, it indicates the connection has been established between transmitter and receiver over fiber cable.

3 After select the DIP switch, press “Group Switch” button for 1 second.

4 Please refer to 5.3.

4 bits DIP Switch:

Use 4bits DIP switch to select 16 groups ID (such as 0001, 0010, 0101 etc)

5.2 Receiver

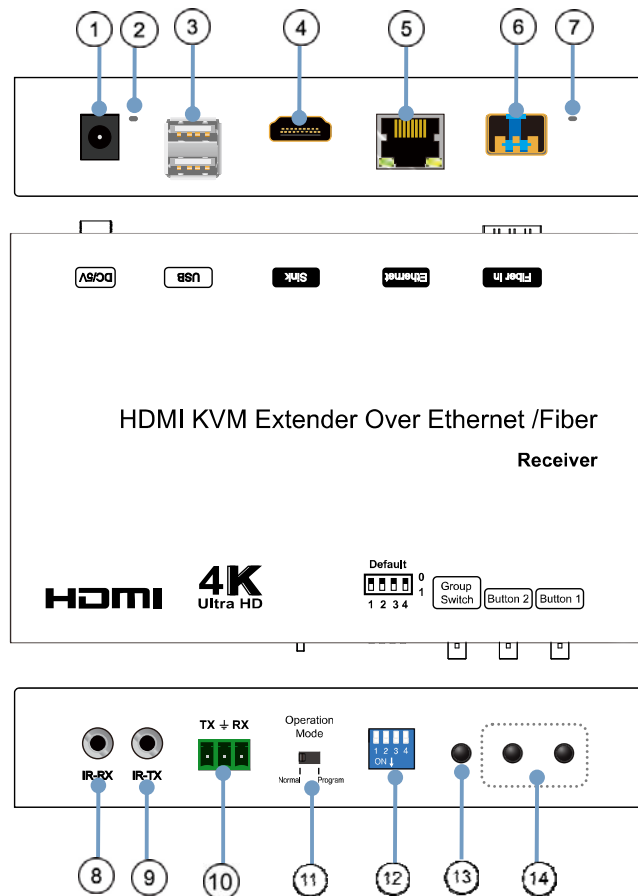

- | | | | |
|------------------------|---|---|------------------|
| 1) Power input port | 2) Power input indicator | 1 | 3) USB |
| 4) HDMI output | 5) Ethernet port | | 6) Fiber In |
| 7) Indicator of status | 8) IR-RX port | 2 | 9) IR-TX port |
| 10) RS232 port | 11) Normal: For serial over IP;
Program: For serial control or getting the debug information | | |
| 12) 4 bit Dip switch | 13) Group Switch | 3 | 14) Button 1 & 2 |
| | | 4 | |

1 A. Green LED: Link LED, when the connection has established over Cat5e/6 cable or Fiber cable, the Green LED will illuminate.

B. Yellow LED: When the yellow LED is blinking, it indicates the connection has been established over Cat5e/6 cable.

2 When the green LED illuminates, it indicates the connection has been established between transmitter and receiver over fiber cable.

3 After select the DIP switch, press “Group Switch” button for 1 second.

4 Please refer to 5.3.

4 bits DIP Switch:

Use 4bits DIP switch to select 16 group ID (such as 0001, 0010, 0101 etc)

5.3 Descriptions Buttons:

(Host: Transmitter; Client: Receiver)

Button State for Unicast Mode: HDMI Extender:

Default Mode will be highlighted in GREEN

* Item will be described in Descriptions

Unicast Digital	Button State			
	Transmitter		Receiver	
	Button One :	Button Two :	Button One :	Button Two :
Short Press	Remote/Loopback*	Video Mode/ Graphic Mode*	Link on : Link Link off : Unlink	Video Mode/ Graphic Mode*
Long Press(3 sec)	Snoop (on/off)*	Anti-Dither (1/2/off)*	N/A	Anti-Dither (1/2/off)*
Short Press when Ethernet Link is Off	BYPASS	BYPASS	BYPASS	BYPASS
Long Press when Ethernet Link is Off	BYPASS	Ethernet Jumbo Frame (on/off)*	BYPASS	Ethernet Jumbo Frame (on/off)*
Long Press on Boot (Press until Red LED Blinking)	Engineering Mode*	N/A	Engineering Mode*	N/A
Long Press on Boot (Press until both Red LED and Green LED Blinking)	Engineering Mode and Reset to default*	N/A	Engineering Mode and Reset to default*	N/A

Descriptions:

Feature /Button Feature	Descriptions
Remote/Loopback	When System is all setup, short press this button will change between remote / local loopback
Snoop (on/off)	When System is all setup and video is displayed at the client side. Long Press this button will for the local loop back port to be enabled for Snooping feature.
Video Mode/ Graphic Mode	<p>User can select to change between Video Mode / Graphic Mode using this button. The button state will be save to flash, and remember after rebooting.</p> <p>Video Mode: FW will automatically trade-off between bandwidth and video quality to ensure smooth video playing experience.</p> <p>Graphic Mode: FW will fix the trade-off to ensure best graphic/text viewing experience.</p>
Anti-Dither (1/2/off)	<p>Anti-Dithering Mode is design to work with ATI graphic cards that provide dithering output. Dithering output is used to make coloring looks better than it's original color depth. It uses visual transient to create a half-tone effect. However, this presents great difficulty for Video Compression to maintain low bandwidth even if the source display seems static.</p> <p>Currently, we only see Dithering Output with ATI graphic cards.</p> <p>To resolve this issue, AST1500 provides Anti-dithering for 1 bit, 2 bit, or off.</p> <p>If the source content does not generate dithering output and this feature is turn on. It will create a blocking effect because Video Engine are unable to detect pixel changes. User can avoid this issue by turning this feature to off.</p>
Engineering Mode	<ol style="list-style-type: none"> 1. Static IP: 192.168.0.88 2. User can connect to http://192.168.0.88 webpage for firmware update. 3. Firmware update file name will be: Host: webfwh.bin Client: webfwc.bin
Reset to Default	<ol style="list-style-type: none"> 1. Reset Any changes in SPI flash setup flag. 2. Re-generate Random mac to avoid any possible MAC collision. After Reset to Default and reboot cycle, a new random mac will be generated.
Ethernet Jumbo Frame	<ol style="list-style-type: none"> 1. This feature is only available on AST1510 and above. AST1500 will be by pass this event. 2. Enable/Disable Ethernet jumbo frame. 3. If link LED is solid then jumbo is enabled. If link LED is blinking then jumbo is disabled.

Buttons that shall not be removed for this setup:

Depending on customer feature needs.

Example: If customer have loopback feature, than button one is required.

Button State for Multicast Mode: HDMI Extender:

Default Mode will be highlighted in GREEN

* Item will be described in Descriptions

Multicast Digital	Button State			
	Transmitter		Receiver	
	Button One:	Button Two:	Button One:	Button Two:
Short Press	Remote/Loopback*	Video Mode/ Graphic Mode*	Link on: Link Link off: Unlink	Video Mode/ Graphic Mode*
Long Press (3 sec)	Snoop (on/off)*	Anti-Dither (1/2/off)	USB Link (on/off)	Anti-Dither (1/2/off)*
Short Press when Ethernet Link is Off	BYPASS	BYPASS	BYPASS	BYPASS
Long Press when Ethernet Link is Off	BYPASS	Ethernet Jumbo Frame (on/off)*	BYPASS	Ethernet Jumbo Frame (on/off)*
Long Press on Boot (Press until Red LED Blinking)	Engineering Mode*	Use Loopback EDID (>A1.2)*	Engineering Mode*	Update EDID*
Long Press on Boot (Press until Red LED and Green LED Blinking)	Engineering Mode and Reset to default*	N/A	Engineering Mode and Reset to default*	N/A

Descriptions:

Feature /Button Feature	Descriptions
Remote/Loopback	When System is all setup, short press this button will change between remote / local loopback
Snoop (on/off)	When System is all setup and video is displayed at the client side. Long Press this button will for the local loop back port to be enabled for Snooping feature.
Video Mode/ Graphic Mode	<p>User can select to change between Video Mode / Graphic Mode using this button. The button state will be save to flash, and remember after rebooting.</p> <p>Video Mode: FW will automatically trade-off between bandwidth and video quality to ensure smooth video playing experience.</p> <p>Graphic Mode: FW will fix the trade-off to ensure best graphic/text viewing experience.</p>
Anti-Dither (1/2/off)	<p>Anti-Dithering Mode is design to work with ATI graphic cards that provide dithering output. Dithering output is used to make coloring looks better than it's original color depth. It uses visual transient to create a half-tone effect. However, this presents great difficulty for Video Compression to maintain low bandwidth even if the source display seems static.</p> <p>Currently, we only see Dithering Output with ATI graphic cards.</p> <p>To resolve this issue, AST1500 provides Anti-dithering for 1 bit, 2 bit, or off.</p> <p>If the source content does not generate dithering output and this feature is turn on. It will create a blocking effect because Video Engine are unable to detect pixel changes. User can avoid this issue by turning this feature to off.</p>
Use Loopback EDID(>A1.2)	This feature should be consider with the client side "Update EDID" feature.
Update EDID	<p>"Use Loopback EDID" & "Update EDID" feature is used for Multicast Mode to select which monitor/TV EDID is used for system wide EDID usage.</p> <p>During multicast setup, there maybe monitor/TV that has lower resolution. For example, 1 monitor/TV with 720p resolution with mostly 1080p solutions. Please select the monitor/TV with lowest resolution, to ensure all can be displayed correctly.</p> <p>For customer that are using 1 pair of Host/Client with Multicast mode, the end user must update EDID correctly. If not, it will cause many compatibility issue.</p> <p>Operation: Once the button event is triggered correctly at the client side, when system is setup correctly for Multicast. The selected EDID will be update to Host Side EEPROM (HU7).</p> <p>The same operation applies for Loopback EDID.</p> <p>In the system setup, the last EDID updated will stay in the EEPROM. If customer setup this button even many times, the last one triggered will be applied.</p>
USB Link (ON/OFF)	<p>This feature is used for USB with Multicast Mode setup.</p> <p>The selected client can gain control by pressing USB Link, and release control by pressing USB Link again.</p> <p>Other clients can also gain control by pressing USB Link. The control will be transfer to whichever client requests USB Link.</p>
Engineering Mode	<ol style="list-style-type: none"> 1. Static IP: 192.168.0.88 2. User can connect to http://192.168.0.88 webpage for firmware update. 3. Firmware update file name will be: Host : webfwh.bin Client : webfwc.bin
Reset to Default	<ol style="list-style-type: none"> 1. Reset Any changes in SPI flash setup flag. 2. Re-generate Random mac to avoid any possible MAC collision. After Reset to Default and reboot cycle, a new random mac will be generated.
Ethernet Jumbo Frame	<ol style="list-style-type: none"> 1. This feature is only available on AST1510 and above. AST1500 will be by pass this event. 2. Enable/Disable Ethernet jumbo frame. 3. If link LED is solid then jumbo is enabled. If link LED is blinking then jumbo is disabled.

6. INSTALLATION

6.1 Device Connection

1. Check the power supply is unplugged.
2. Set up the group of the transmitter with the correspondent receiver for signal extension and display.
3. Connect the Transmitter to video source with HDMI cable, and connect Receiver to a monitor or display with HDMI cable.
4. Connect the USB cables from Transmitter to PC, and connect the USB additional devices such as USB mouse, USB keyboard and USB pen drive to Receiver.
5. Connect Transmitter and Receiver to the Ethernet switch with network cable.
6. Power on the Transmitter, Receiver and all the connected devices.
7. Power on and activate all the connected devices.
8. Connect the IR extension cable with Transmitter and the IR receiver cable with Receiver for remote control.

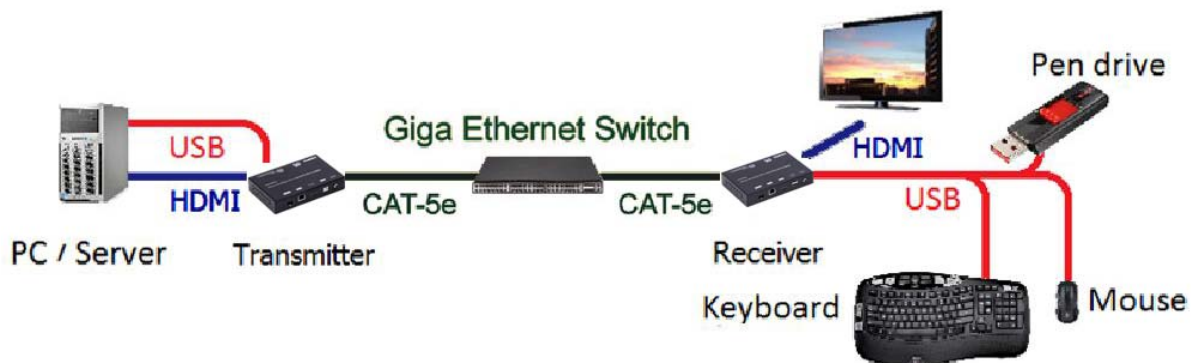

◆ Configuration

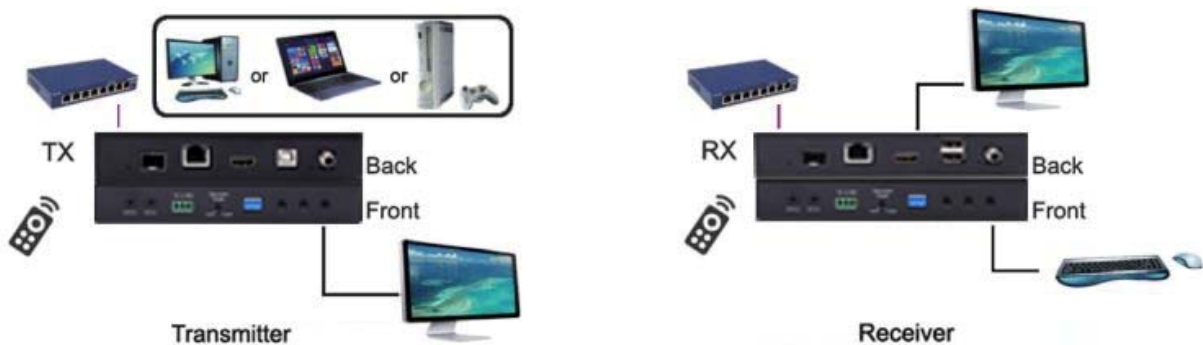

◆ Application Pattern

■ Unicast

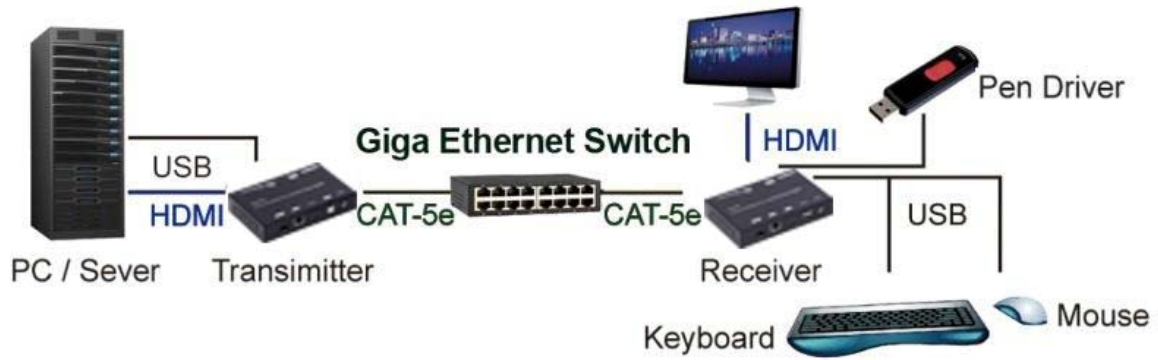

■ Multicast

a. Video Distribution

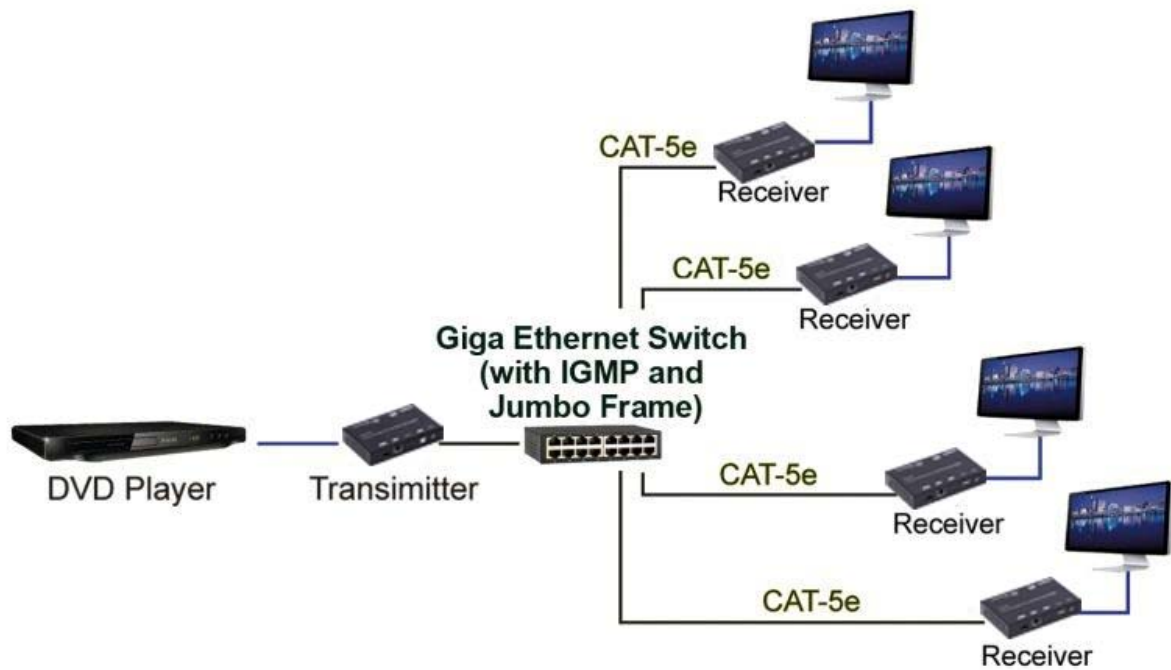

b. Matrix Distribution

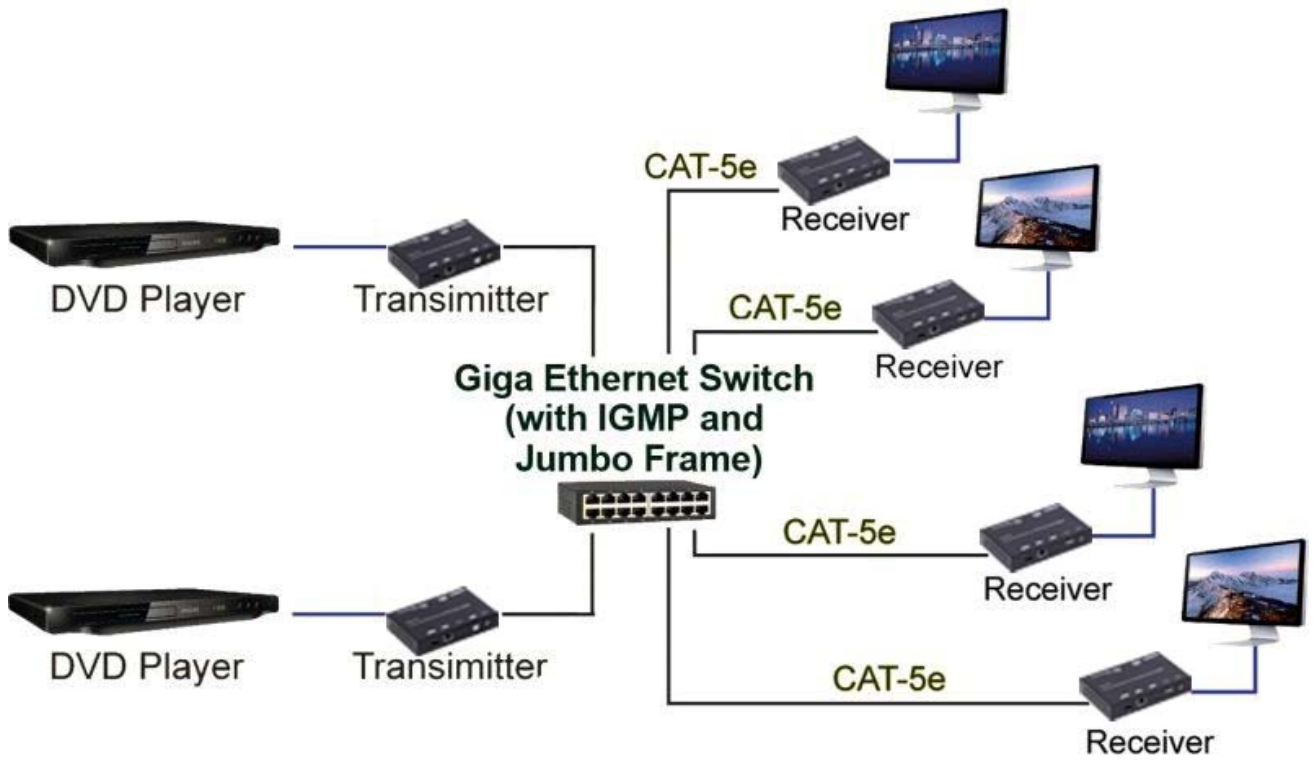

c. Billboard & Kiosk, PC to HDMI and USB Interactive Monitor

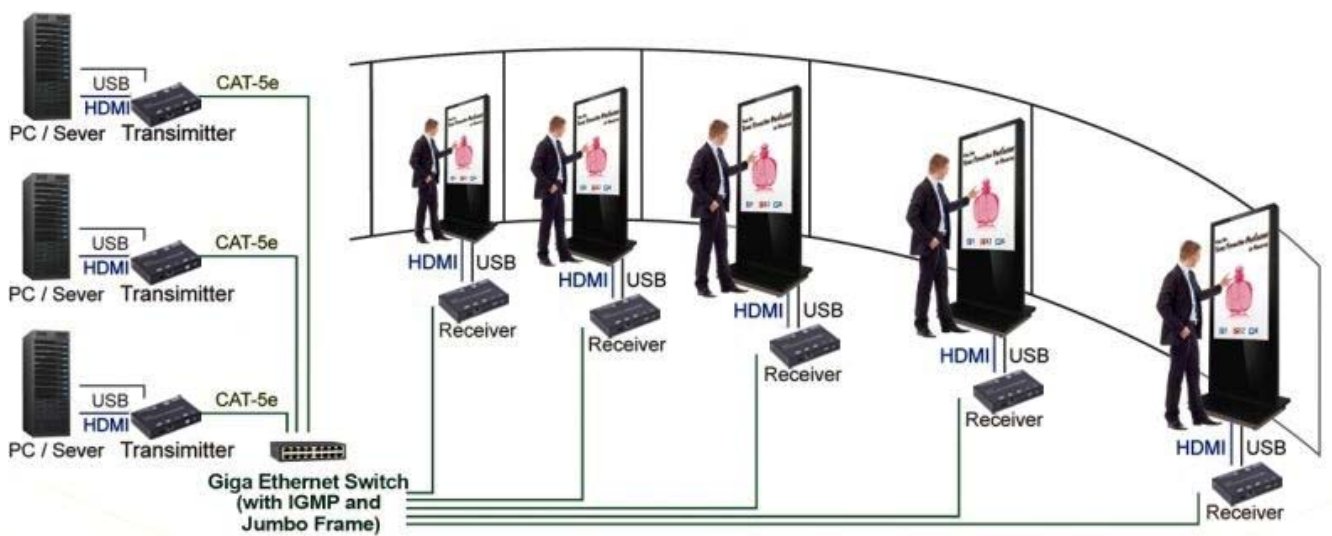

■ Screen Wall

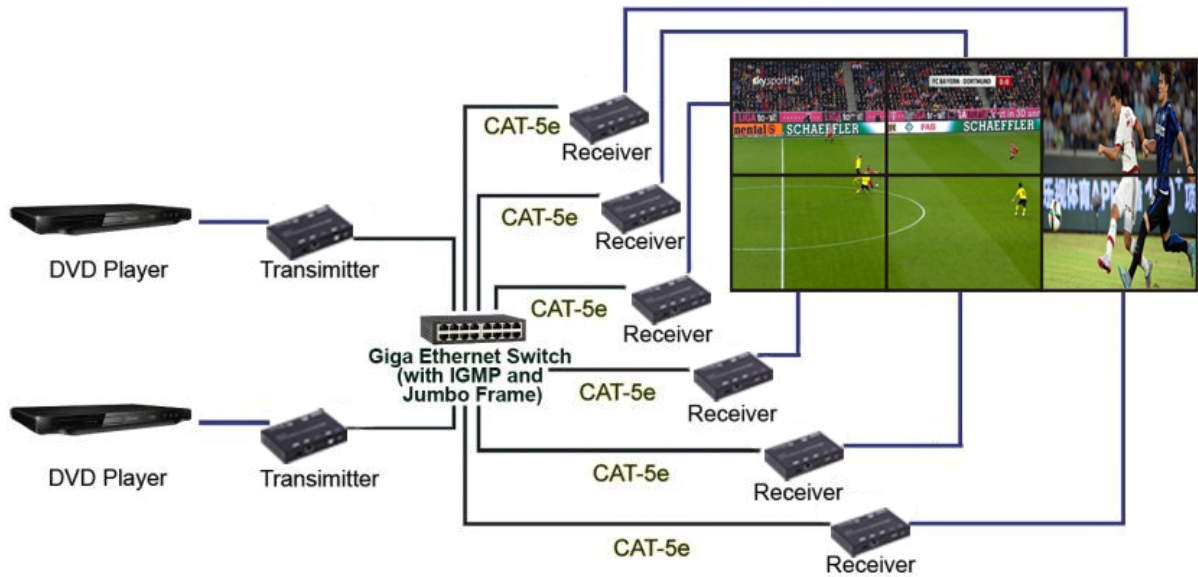

6.2 IP Configuration

The 4K HDMI & USB Over IP Extender can configure via LAN in the same subnet.

1. Assign a LAN IP address to the computer in the same subnet. The IP address default of the Transmitter and Receiver is B class Networking:

169.254.xxx.xxx.



Figure 1. Internet Protocol (TCP/IP) Properties

2. Connect the TX and RX with the Ethernet switch, Then connect the PC with the Ethernet switch.

Because this unit support DHCP, Different unit with different IP address of the factory reset, so The first thing we need know the IP address of each unit.

There is two way to get the IP address

1) Via “Node List”

Open the “Node List “in the “Tool” file, Press twice the “Node_list.bat” to enter the dialog box

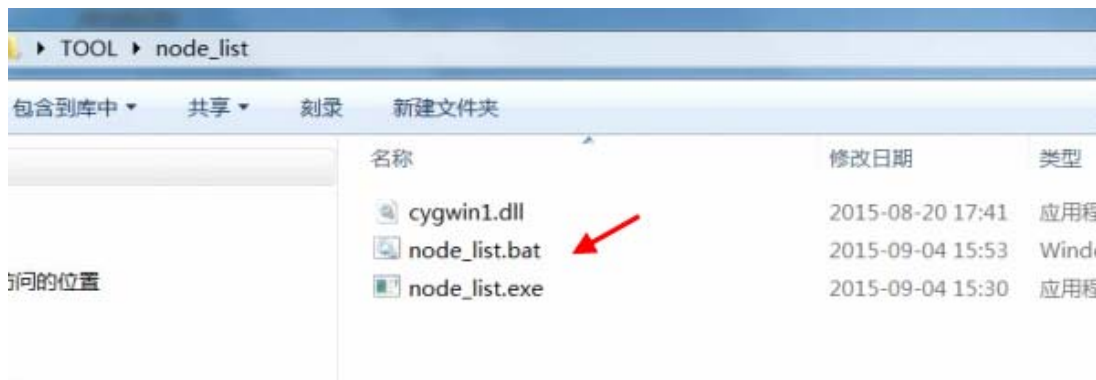

Then we can see all the IP address of both the TX and RX show as bellow black dialog box.

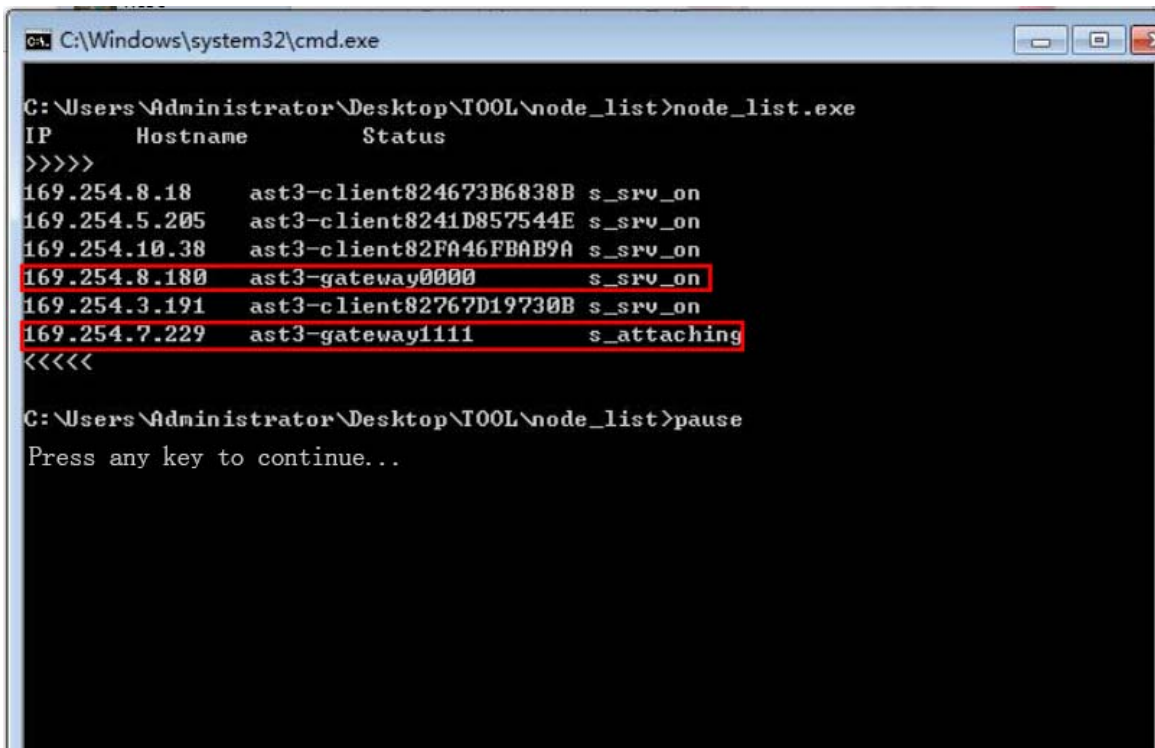

Remark: If the IP address with “Client”, It’s the IP address of the RX
If the IP address with “Gateway”, It’s the IP address the TX.

2) The second way.

Connect all devices with proper cables except video source, please refer to Figure 2

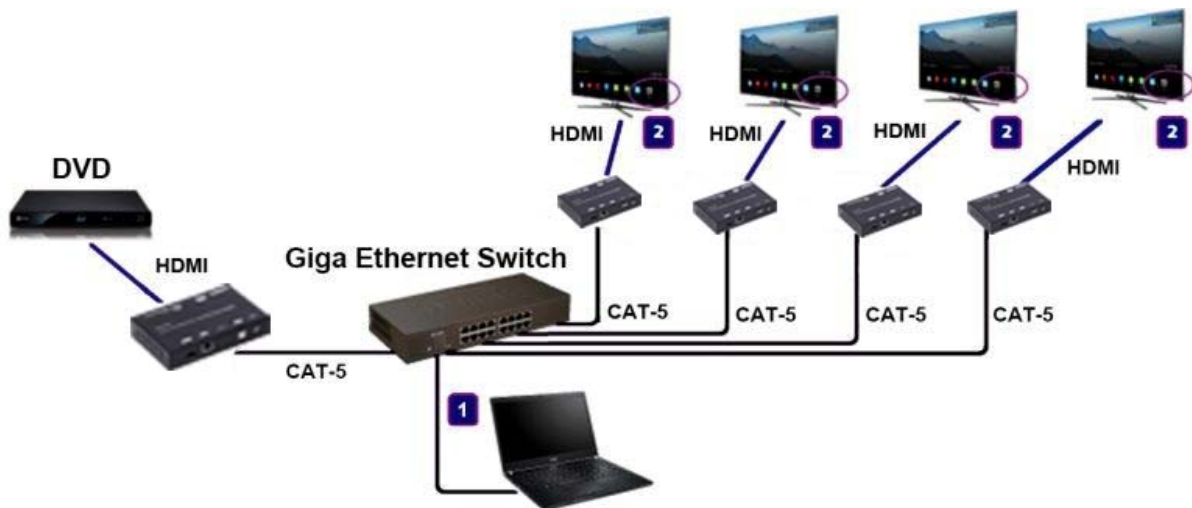

Figure 2. Demonstrate the 4K HDMI & USB Over IP Extender

3) After activation, the device information including the Transmitter and Receiver IP address will be shown in the lower right corner. Remember the Transmitter and Receiver IP address on monitor screen and then plug HDMI video source cable into Transmitter.



Figure 3. Device IP Indication

3. The administrator can input Transmitter or Receiver IP address into address bar of web browser (Recommend the Google Chrome) to enter the Extender Web UI.

If link success, administrator will see the Web UI as shown in Figure 4.

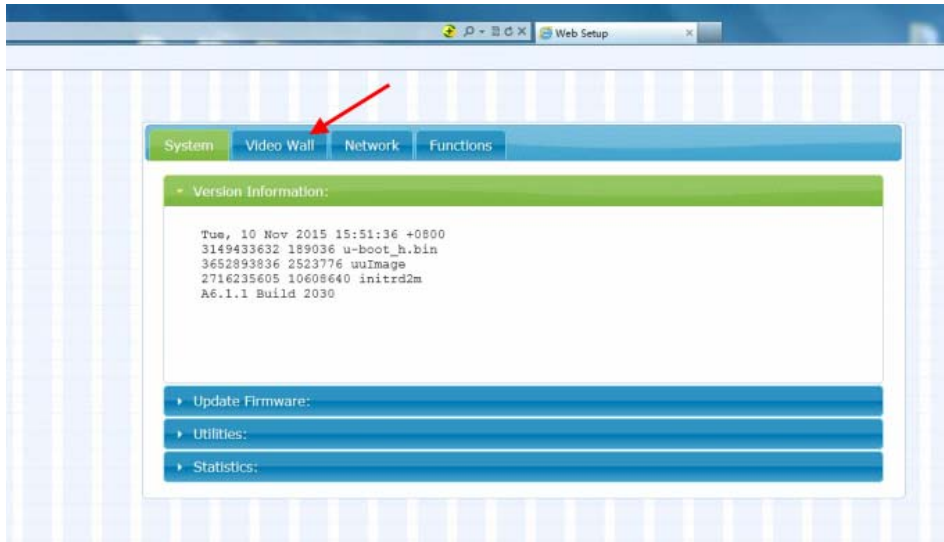

Figure4. Web User Interface

7. WEB USER INTERFACE CONFIGURATION

7.1 System

The relevant information of the connected extender and setting

7.1.1 [Version Information]

Indicating the firmware version and relevant information of the devices

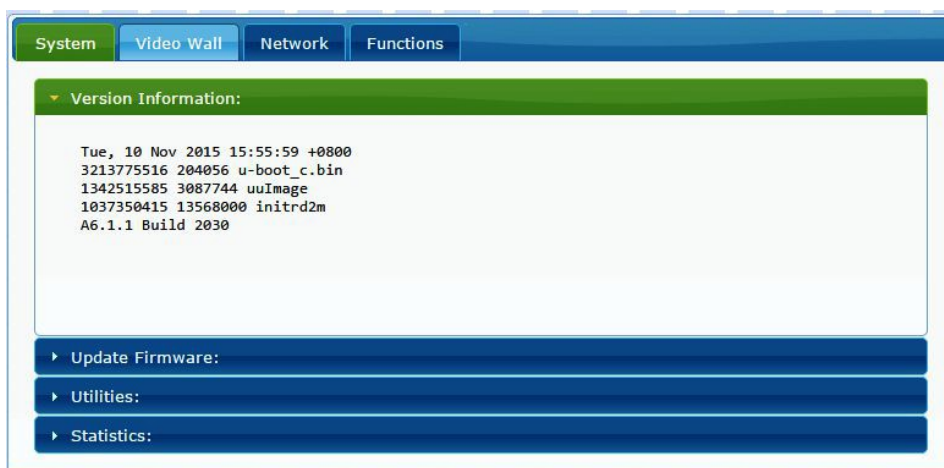

7.1.2 [Update Firmware]

To update the firmware of the connected extender, please click on the [Select File] to select the firmware and click on [Upload] to upload the firmware and update accordingly.

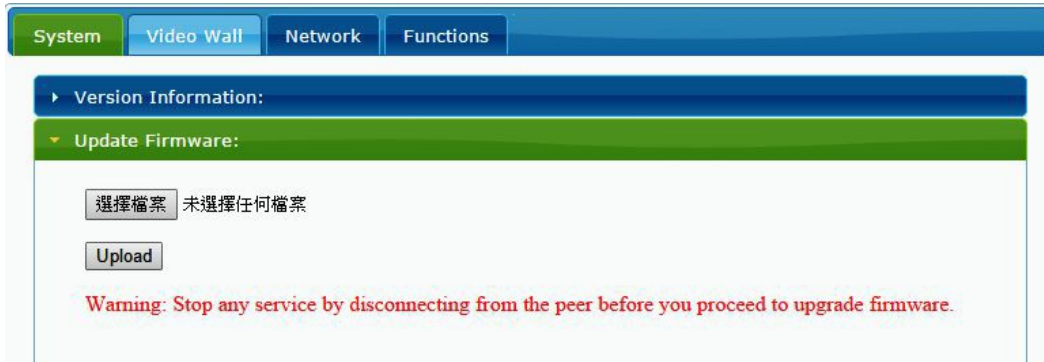

- Transmitter Firmware Update: please select [webfw.bin] to update
- Receiver Firmware Update: please select [webfwc.bin] to update

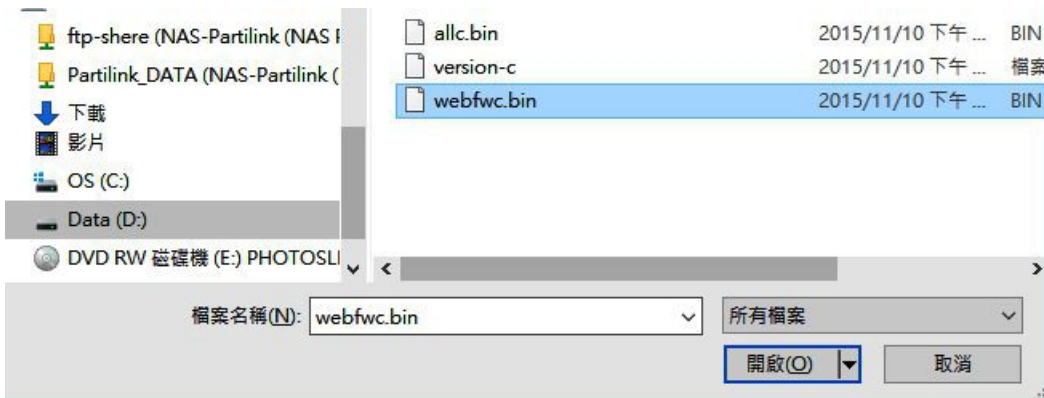

It takes time to update the firmware. During the process of update, the Web user interface shows the status as below diagram. The extender system will reboot automatically after updating firmware. If it doesn't reboot automatically, please reboot to apply the new firmware manually.

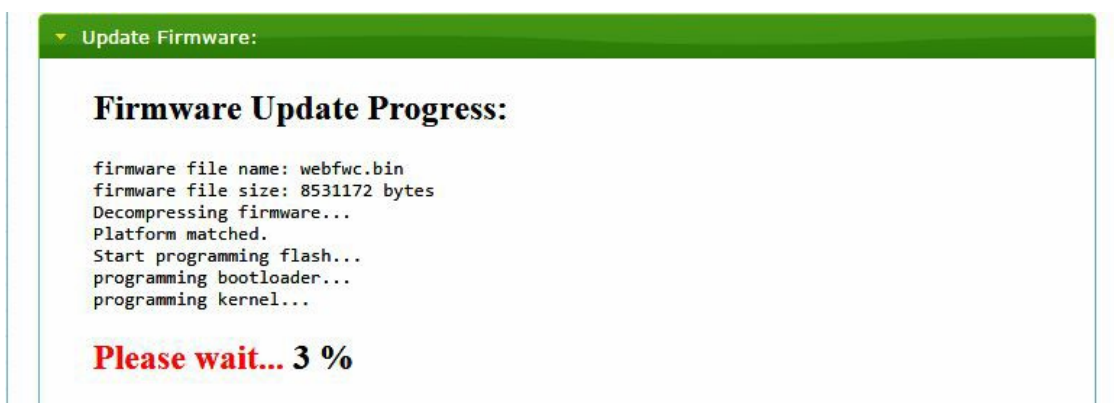

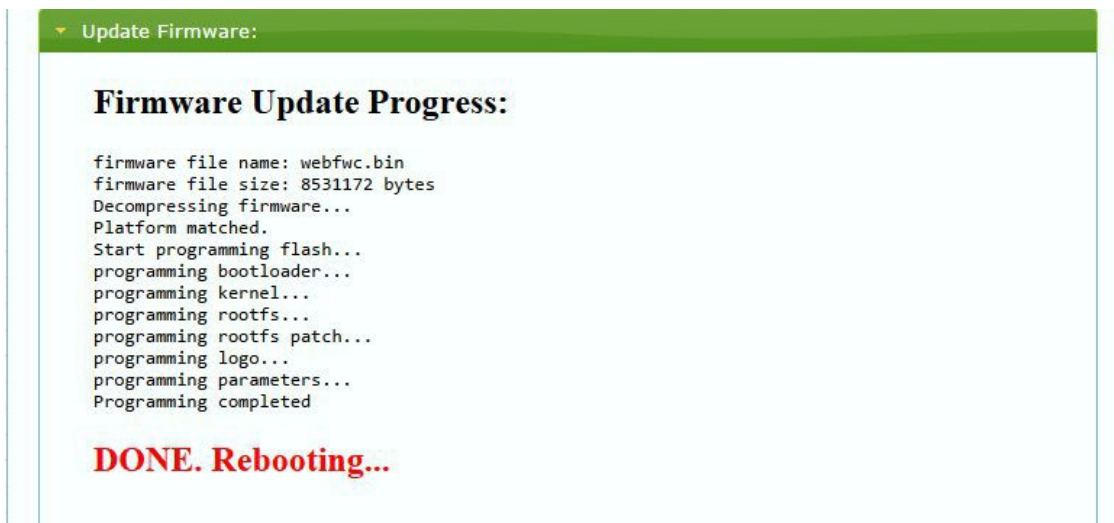

7.1.3 [Utilities]

There are some functions

- **Factory Default:** Click on to return to the factory default when necessary
- **Reboot:** Click on to reboot the extender system
- **Console API Command:** Input Linux command for advanced setting

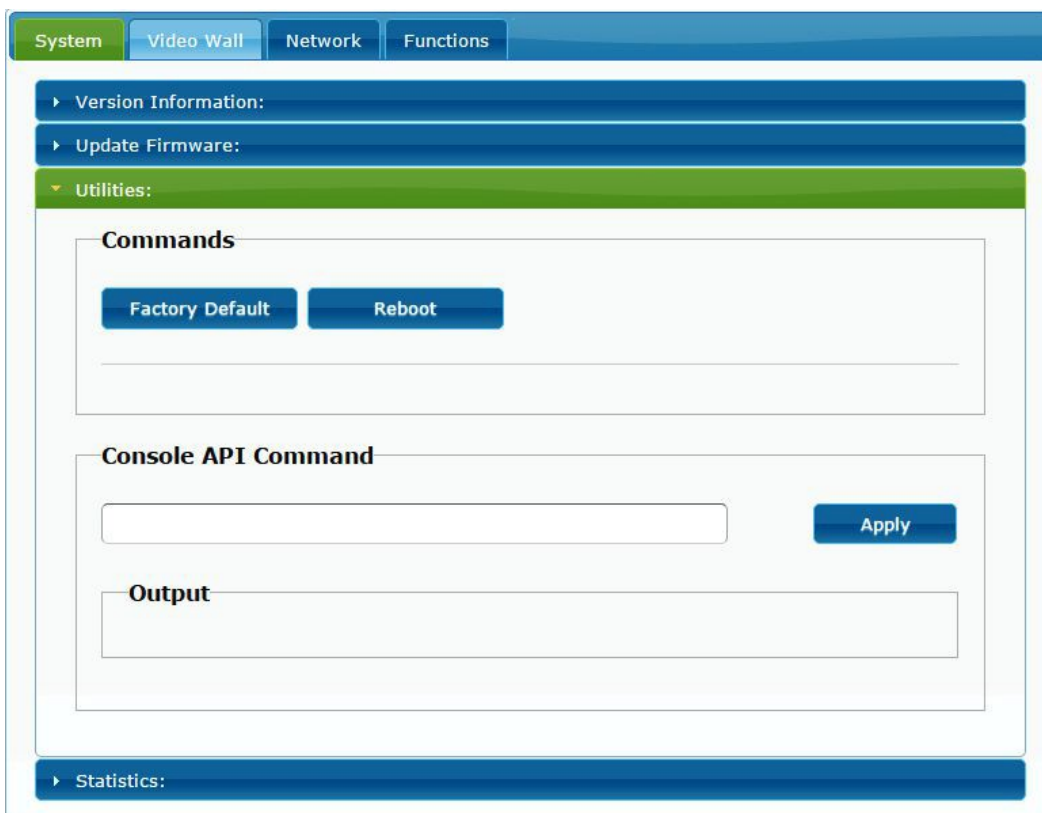

7.1.4 [Statistics]

Indicating the extender linking and working status

The screenshot displays a web interface with a navigation bar at the top containing tabs for 'System', 'Video Wall', 'Network', and 'Functions'. The 'Network' tab is selected. Below the navigation bar, there is a list of expandable sections: 'Version Information:', 'Update Firmware:', 'Utilities:', and 'Statistics:'. The 'Statistics:' section is expanded, revealing three sub-sections: 'State Machine', 'Network', and 'Video'.

State Machine

State: s_search

Network

ID (Host Name): 82CA8D853D73

IP Address: 169.254.6.167

Subnet Mask: 255.255.0.0

Default Gateway: 169.254.0.254

MAC Address: 82CA8D853D73

Casting Mode: Unicast Mode

Link Status: on

Link Mode: 1G

Video

Local Video Output:

attached=n

Video Timing Information:

timing=[34] 640x480p@60Hz H- V-
type=RGB
HDCP=n (Disable)
color depth=0

7.2 Video Wall

To set up the video wall application

7.2.1 [Basic Setup]

The screenshot shows the 'Basic Setup' configuration page for a video wall. It is divided into three main sections: 'Bezel and Gap Compensation', 'Wall Size and Position Layout', and 'Preferences'.
1. **Bezel and Gap Compensation:** This section contains four input fields for OW, OH, VW, and VH, each with the value '1'. To the right is a diagram of a single monitor panel with dashed lines indicating the outside width (OW), outside height (OH), viewable width (VW), and viewable height (VH). The unit is specified as 0.1mm.
2. **Wall Size and Position Layout:** This section contains four dropdown menus: 'Vertical Monitor Count' (set to 1), 'Horizontal Monitor Count' (set to 1), 'Row Position' (set to 0), and 'Column Position' (set to 0). To the right is a diagram showing a 2x2 grid of monitor panels with dashed lines indicating the overall dimensions and the unit 'Panel'.
3. **Preferences:** This section contains two dropdown menus: 'Stretch Type' (set to 'Fit In') and 'Clockwise Rotate' (set to 0).
At the bottom, there is an 'Apply To' dropdown set to 'This device connected by your browser', an 'Apply' button, and a 'Show OSD' checkbox.

- **Bezel and Gap Compensation:**

Dimension of the screen (inside and outside width and height)

OW: outside width **OH:** outside height

VW: viewable width **VH:** viewable height

Please NOTE:

- 1) The viewable width must be less than the outside width, and the viewable height must be less than the outside height.
- 2) If administrator doesn't need this, just set all values to 0.
- 3) The unit is 0.1mm and the value MUST be integer.

Bezel and Gap Compensation

OW:

OH:

VW:

VH:

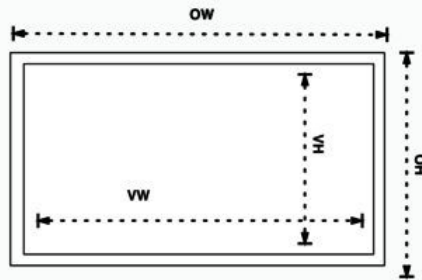

UNIT: 0.1mm

- **Wall Size and Position Layout:**

Select number of vertical and/ or horizontal monitors, row position and column position. Vertical monitor number 1~8, horizontal monitor number 1~16

Wall Size and Position Layout

Vertical Monitor Count:

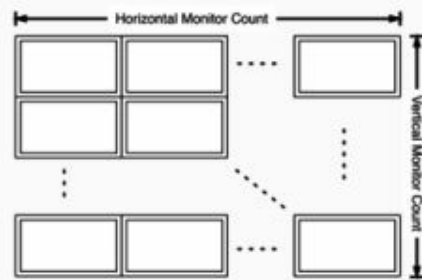

UNIT: Panel

Wall Size and Position Layout

Vertical Monitor Count:

Horizontal Monitor Count:

Row Position:

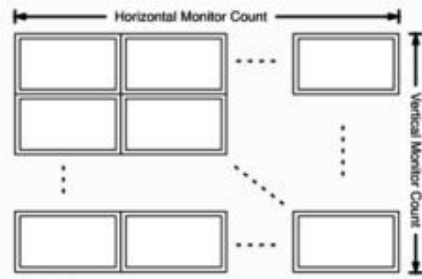

UNIT: Panel

Preferences

Wall Size and Position Layout

Vertical Monitor Count:

Horizontal Monitor Count:

Row Position:

Column Position:

UNIT: Panel

Apply To: connected by your browser

- **Preferences:** Select the video fit in the screen or stretch out and the rotate angle

Preferences

Stretch Type:

Clockwise Rotate:

Preferences

Stretch Type:

Clockwise Rotate:

Apply To: "This" device connected by your browser

- **Apply To:**

- 1) All: Configure all Transmitter and Receiver in the same Group IP.
- 2) This (Local): The IP you input into address bar of web browser.
- 3) Hosts or Clients: select which Transmitter or Receiver you want to configure.

Preferences

Stretch Type: ▼

Clockwise Rotate: ▼

Apply To: "All" device(s) in the list

All	Apply
This	
Hosts: 0000:169.254.10.103	
Clients: 0:169.254.4.78	

- **Show OSD:**

Check this box to output each receiver's specific number to the connected monitor

Preferences

Stretch Type: ▼

Clockwise Rotate: ▼

Apply To: "This" device connected by your browser

▼

Show OSD

▶ Advanced Setup:

Before enter “Advanced Setup”, please complete the “Basic Setup” as follows:

Step1: In “Basic Setup”, select Vertical and Horizontal Monitor Count. For example Vertical Monitor Count = 3, Horizontal Monitor Count = 5

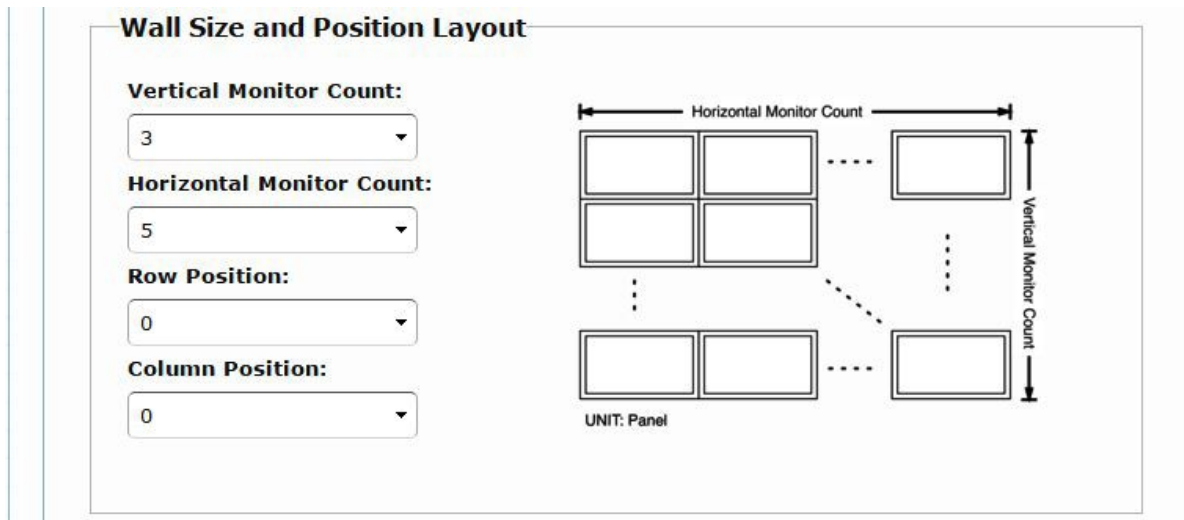

Sept2: In “Advanced Setup”, choose the target of the video wall to control

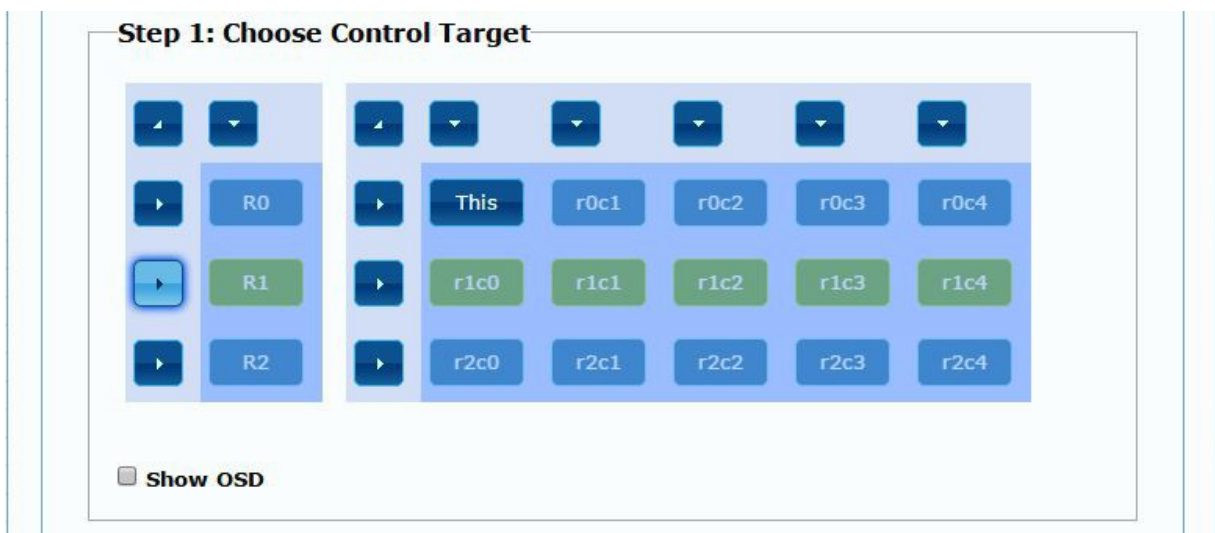

If user make incorrect operations, press “Reset” in Reset to Basic Setup function.

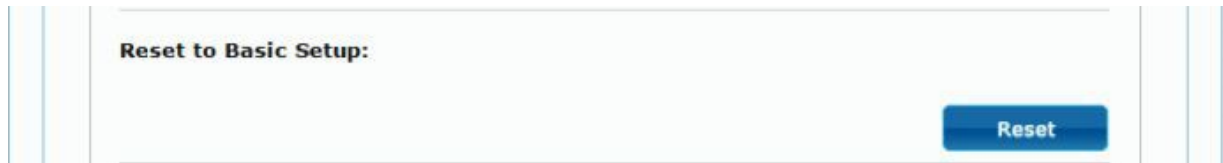

Setup the video output to “Fit In’ or “Stretch Out” mode in the screen



Setup the rotation angle of the video output



Set up the number of vertical and horizontal monitor based on the video wall layout. Vertical number 1~8 and horizontal number 1~16.

Setup the row position of monitor, number from 0 to the total number of vertical monitor.



Setup the column position of monitor, number from 0 to the total number of horizontal monitor.

Row Position:

0

0

1

2

3

4

5

6

7

Apply

Column Position:

0

0

1

2

3

4

5

6

7

8

9

10

11

12

13

14

15

Apply

Setup the video position shift and video enlarge.

- **Horizontal Shift:** Setup the video horizontal shift, Left or Right
- **Vertical Shift:** Setup the video vertical shift, Up or Down
- **Horizontal Scale Up:** Setup the video horizontal scale up
- **Vertical Shift Scale Up:** Setup the video vertical shift scale up.

Horizontal Shift:

Left Right 0

Apply

Vertical Shift:

Up Down 0

Apply

Horizontal Scale Up (N pixels/column_count):

0

Apply

Vertical Scale Up (N pixels/row_count):

0

Apply

- **Consol API Command:** Input Linux command to do advanced setup.



7.3 Network: Update the network setup of the extender system

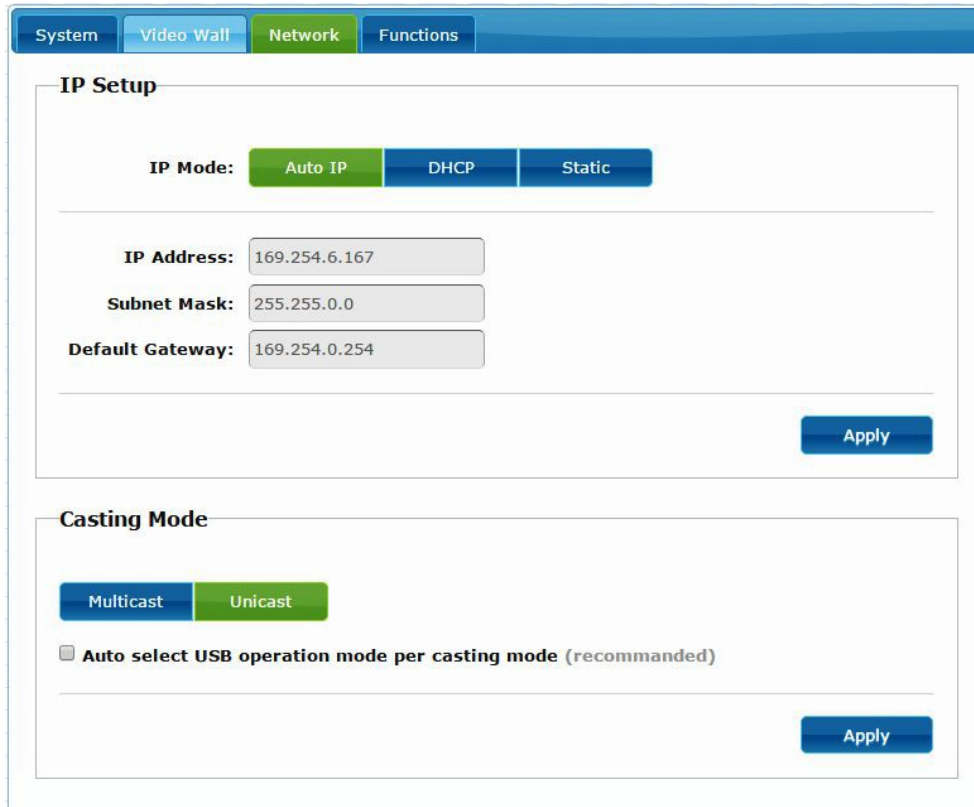

7.3.1 [IP Setup]

- **Auto IP:** use automatically Extender assign IP system for example:
169.254.xxx.xxx.



- **DHCP:** use the DHCP of the external device such as the IP sharer to assign IP.

IP Setup

IP Mode: Auto IP DHCP Static

IP Address:

Subnet Mask:

Default Gateway:

- **Static:** use the static IP to assign manually.

IP Setup

IP Mode: Auto IP DHCP Static

IP Address:

Subnet Mask:

Default Gateway:

7.3.2 [Casting Mode]

Select the broadcast mode of the extender application

- **Multicast:** point to multiple points or multiple point to multiple points broadcast
- **Unicast:** point to point broadcast

Casting Mode

Multicast Unicast

Auto select USB operation mode per casting mode (recommended)

7.4 Functions:

Setup the video output and USB extension mode for Transmitter

The screenshot shows the 'Functions' tab of a configuration interface. It is divided into two sections: 'Video over IP' and 'USB over IP'.
Video over IP section:
- Enable Video over IP
- Enable Video Wall
- Copy EDID from this Video Output (Default disabled under multicast mode)
- Scaler Output Mode: Pass-Through (dropdown menu)
- Timeout for Detecting Video Lost: 10 seconds (dropdown menu)
- Turn off screen on video lost
- Apply button
USB over IP section:
- Enable USB over IP
- Operation Mode:
 - Auto select mode (Recommended, choose per network casting mode)
 - Active on link (Unicast network's default mode)
 - Active per request (Multicast network's default mode)
- Compatibility Mode:
 - K/M over IP (Uncheck when mouse/keyboard/touch panel not working as expected)
- Apply button

Setup the video output and USB extension mode for Receiver

The screenshot shows the 'Functions' tab of a configuration interface for a receiver. It is divided into two sections: 'Video over IP' and 'USB over IP'.
Video over IP section:
- Enable Video over IP
- Enable Video Wall
- Maximum Bit Rate: Best Effort (dropdown menu)
- Maximum Frame Rate: Capture up to 100% of frames (slider control)
- Apply button
USB over IP section:
- Enable USB over IP
- Operation Mode:
 - Auto select mode (Recommended, choose per network casting mode)
 - Active on link (Unicast network's default mode)
 - Active per request (Multicast network's default mode)
- Compatibility Mode:
 - Mouse not responding well (Check when USB mouse responding is slow and queer)
 - K/M over IP (Uncheck when mouse/keyboard/touch panel not working as expected)
- Apply button

7.4.1 [Video over IP]: Setup the video output mode

- **Enable Video over IP:** Check to enable video extension over IP
- **Enable Video Wall:** Check to enable the video extension for building up video wall
- **Enable EDID Copy:** This function is limited to copy one of the receivers.
- **Scaler Output Mode:** Select the required scalar output mode or select “customize” and input 8 Hex values for more video output resolution and refresh rate selections.
 - 1) 80000004: HD 720p60
 - 2) 81000061: WXGA 1366x768@60
 - 3) 81000040: WXGA+ 1440x900@60
 - 4) 81000051: WUXGA 1920x1200@60
 - 5) 8100003C: SXGA+ 1400x1050@60
- **Timeout for Detecting Video Lost:** Setup the time of stop the video storage when detecting video lost to transmit

Customize Scalar Output Mode for Transmitter

The screenshot displays the configuration interface for a transmitter, specifically the 'Video over IP' section. The interface includes a navigation bar with tabs for 'System', 'Video Wall', 'Network', and 'Functions'. The 'Video over IP' section contains several settings:

- Enable Video over IP**
- Enable Video Wall**
- Copy EDID from this Video Output** (Default disabled under multicast mode)
- Scaler Output Mode:** A dropdown menu is open, showing options: Pass-Through (selected), Full HD 1080p60, Full HD 1080p50, Ultra HD 2160p30, Ultra HD 2160p25, and Customize.
- Timeout for Detecting Video Lost:** A dropdown menu is open, showing options: 10s, 20s, 30s, 40s, 50s, 60s, 70s, 80s, 90s, 100s, 110s, 120s, 130s, 140s, 150s, 160s, 170s, 180s, 190s, 200s, 210s, 220s, 230s, 240s, 250s, 260s, 270s, 280s, 290s, 300s, 310s, 320s, 330s, 340s, 350s, 360s, 370s, 380s, 390s, 400s, 410s, 420s, 430s, 440s, 450s, 460s, 470s, 480s, 490s, 500s, 510s, 520s, 530s, 540s, 550s, 560s, 570s, 580s, 590s, 600s, 610s, 620s, 630s, 640s, 650s, 660s, 670s, 680s, 690s, 700s, 710s, 720s, 730s, 740s, 750s, 760s, 770s, 780s, 790s, 800s, 810s, 820s, 830s, 840s, 850s, 860s, 870s, 880s, 890s, 900s, 910s, 920s, 930s, 940s, 950s, 960s, 970s, 980s, 990s, 1000s.
- Turn off screen on video lost**

An **Apply** button is located at the bottom right of the 'Video over IP' section. Below this section is the 'USB over IP' section, which includes:

- Enable USB over IP**
- Operation Mode:**
 - Auto select mode** (Recommended, choose per network casting mode)
 - Active on link** (Unicast network's default mode)
 - Active per request** (Multicast network's default mode)

- Customize Scalar Output Mode for Receiver

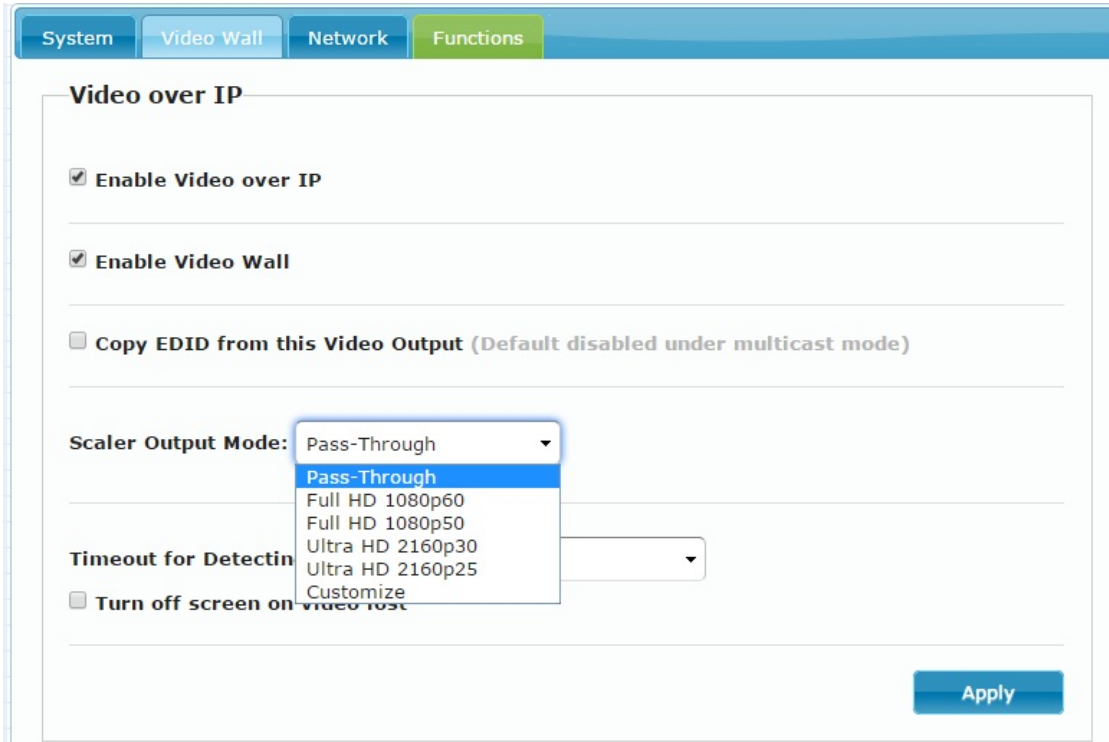

- Timeout for Detecting Video Lost

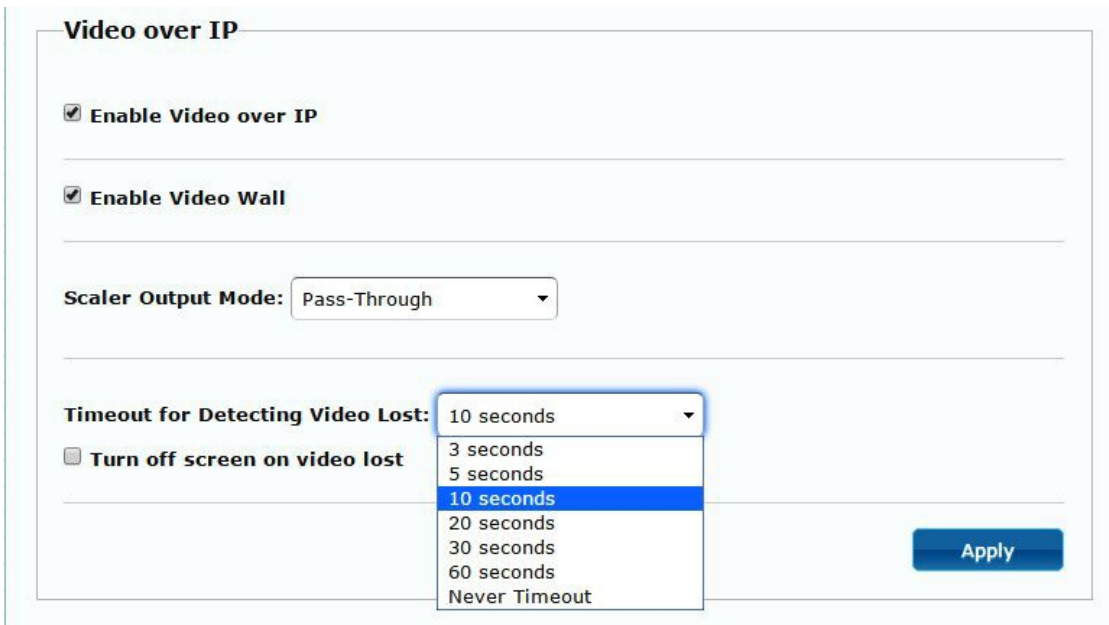

7.4.2 [USB over IP]: Setup the USB extension mode

- **Enable USB over IP:** Check to enable USB extension mode over IP
- **Operation Mode:** Including “auto select mode”, “active on line” and “active per request” modes for option.
- **Compatibility Mode:** Check to enable USB keyboard, USB mouse transmission mode.

USB over IP

Enable USB over IP

Operation Mode:

- Auto select mode (Recommended, choose per network casting mode)
- Active on link (Unicast network's default mode)
- Active per request (Multicast network's default mode)

Compatibility Mode:

- K/M over IP (Uncheck when mouse/keyboard/touch panel not working as expected)

[Apply](#)

7.4.3 [Serial over IP]: set up the serial extension mode

- Select Type 2 as operation mode
- Set up the baud rate for Type 2.

Serial Over IP

Serial over IP

Enable Serial over IP

Operation Mode:

- Type 1 (Need extra control instruction. For advanced usage.)
- Type 2 (Recommended. Dumb redirection.)
- Type 1 guest mode
- Type 2 guest mode

Baudrate Setting for Type 2:

Baudrate:

Data bits:

Parity:

Stop bits:

[Apply](#)

Broadcast Mode Setting

Casting Mode

Multicast Unicast

Auto select USB operation mode per casting mode (recommended)

[Apply](#)

8. BROADCAST CONFIGURATION SETTING

There are some examples to show the setup for unicast, multicast, matrix and video wall. Broadcast setting including unicast and multicast

8.1 Multicast:

To enable the USB interactive devices controlled by turns, please check “Auto select USB operation mode per casting mode”

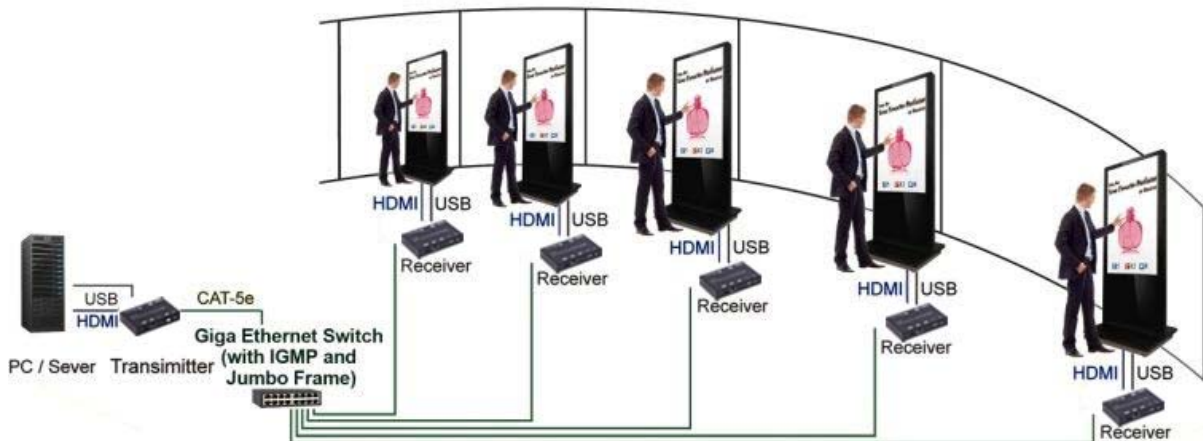

8.2 Unicast:

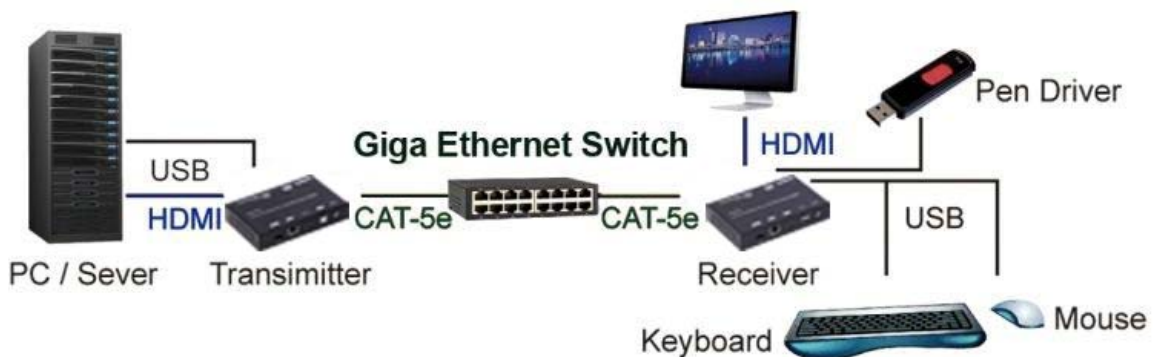

8.3 Matrix:

Install multiple transmitters and setting ID of these transmitters individually, edit the group of transmitters and receivers. The correspondent receivers will output the video from the transmitter belonged to the same group ID.



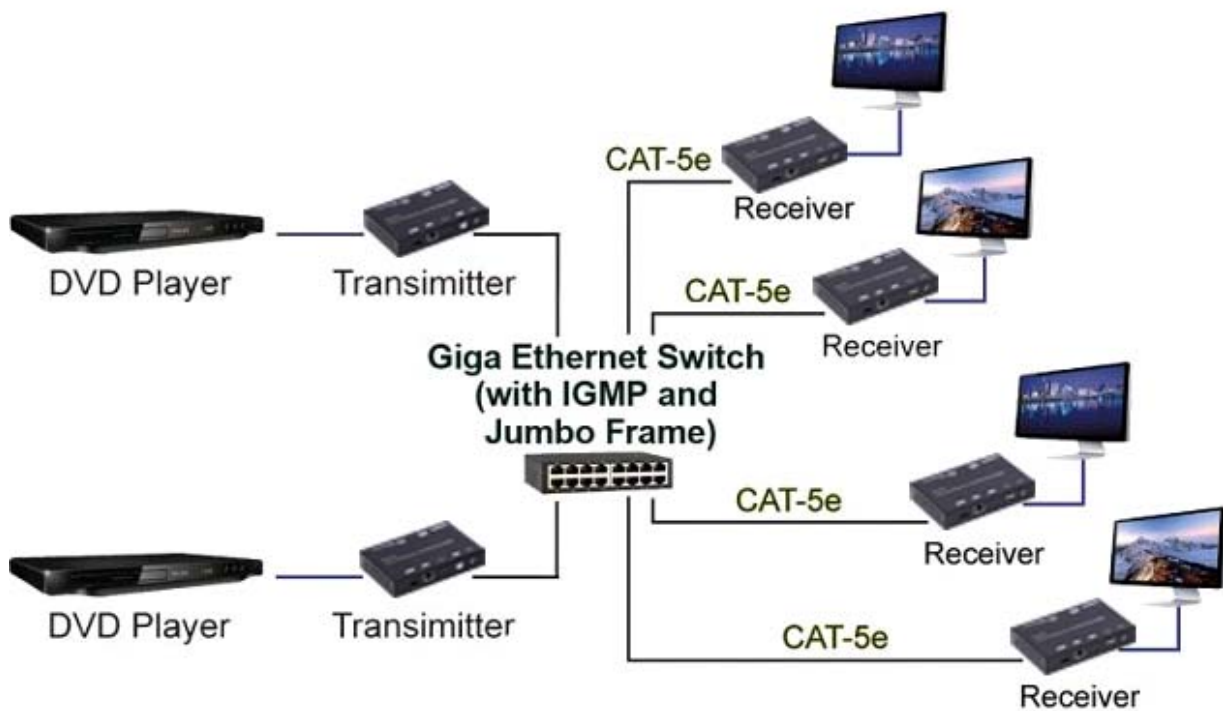

8.4 Video wall:

A 3X5 (row x column) video wall setting example here for reference. In multicast and matrix application mode, access the Web user interface of correspondent receiver to setup.

8.4.1 (Basic Setup)

Please refer to “Section 6.2.1 Basic setup” and follow the steps as below.

- Step1: Set up the vertical monitor count to “3”
- Step 2: Set up the horizontal monitor count to “5”
- Step 3: Set up the row position of the monitor to 0
- Step 4: Set up the column of the monitor to 0
- Step 5: Apply the setting to the extender system

Administrator can complete each Extender position setting after follow 5 steps in above. And then follow the above steps to set the other extenders to the rest of row and column positions from 0x1, 0x2, 0x3 to 3x5

After the basic setup of the video wall, please access the advanced setup to proceed other detailed setting of the video output.

8.4.2 Advanced Setup

Select the monitor you want to control. The one you select will show “This” in green in video wall matrix layout. Take below diagram for example, the monitor we select to control here is the monitor in the upper left corner.



Example for the video wall control

Here's the diagram of the actual video wall layout showing the selected monitor in the upper left corner with green outline.

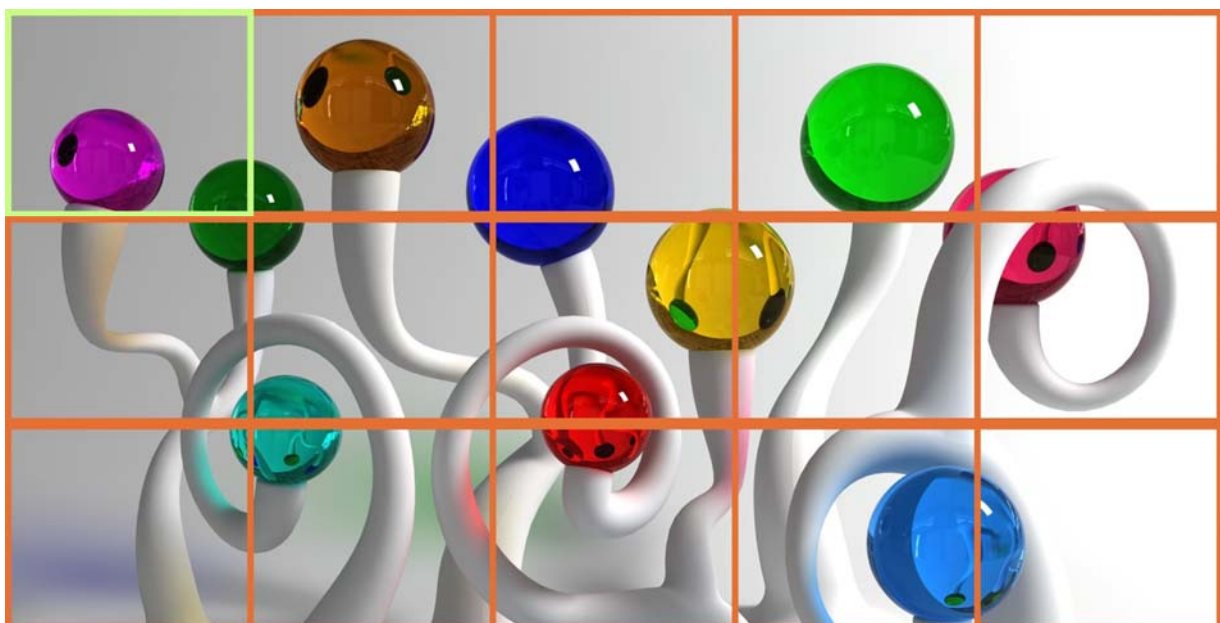

Returned to the previous setup of video wall quickly when incorrect operation was input



Reset

Adjust the horizontal position of the video output, "Left/Right Shift", the selected monitor to adjust is shown with green outline.

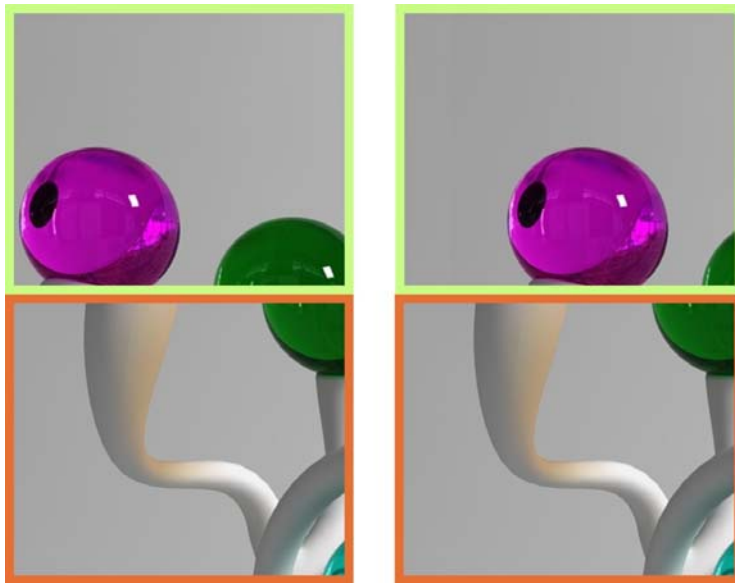

Adjust the vertical position of the video output, "Up/Down Shift", the selected monitor to adjust is shown with green outline.

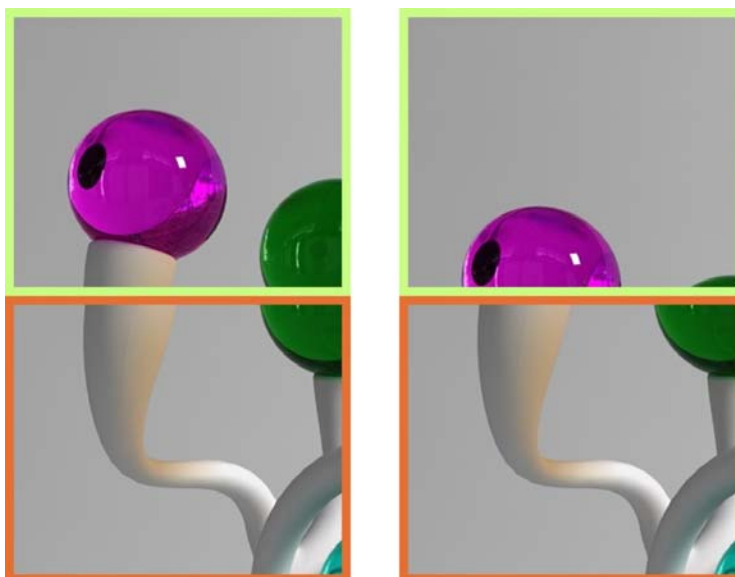

Horizontal Scale Up: To scale up the video output horizontally as the monitor shown with green outline

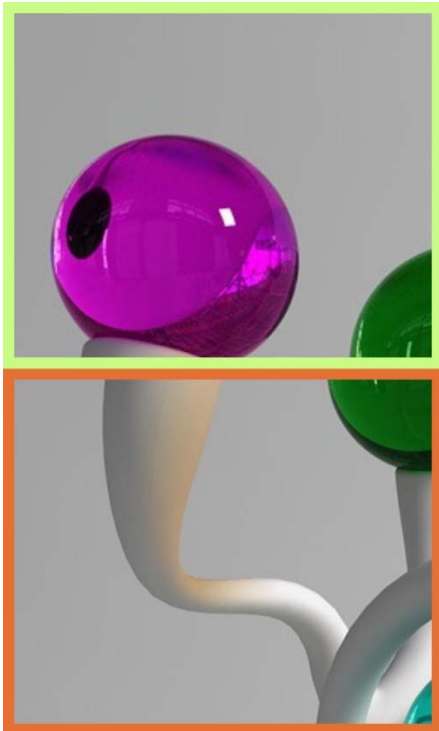

Vertical Scale Up: To scale up the video output vertically as the monitor shown with green outline

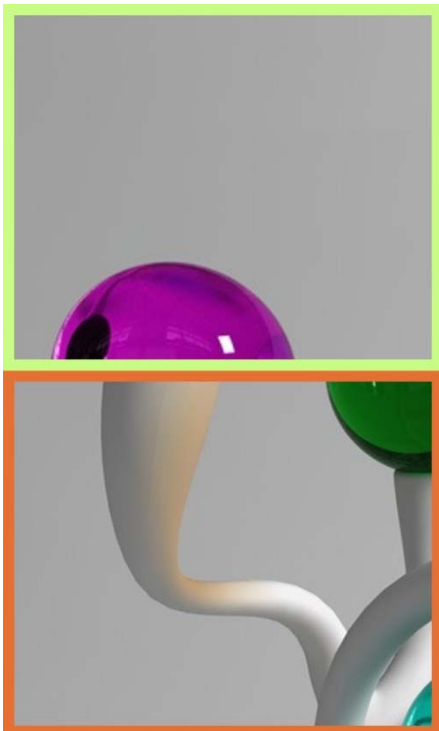

WARRANTY

If your product does not work properly because of a defect in materials or workmanship, our Company (referred to as "the warrantor") will, for the length of the period indicated as below, (Parts(2)Year, Labor(90) Days) which starts with the date of original purchase ("Limited Warranty period"), at its option either(a) repair your product with new or refurbished parts, or (b) replace it with a new or a refurbished product. The decision to repair or replace will be made by the warrantor.

During the "Labor" Limited Warranty period there will be no charge for labor. During the "Parts" warranty period, there will be no charge for parts. You must mail-in your product during the warranty period. This Limited Warranty is extended only to the original purchaser and only covers product purchased as new. A purchase receipt or other proof of original purchase date is required for Limited Warranty service.

MAIL-IN SERVICE

When shipping the unit carefully pack and send it prepaid, adequately insured and preferably in the original carton. Include a letter detailing the complaint and provide a day time phone and/or email address where you can be reached.

LIMITED WARRANTY LIMITS AND EXCLUSIONS

This Limited Warranty ONLY COVERS failures due to defects in materials or workmanship, and DOES NOT COVER normal wear and tear or cosmetic damage.

The Limited Warranty ALSO DOES NOT COVER damages which occurred in shipment, or failures which are caused by products not supplied by warrantor, or failures which result from accidents, misuse, abuse, neglect, mishandling, misapplication, alteration, faulty installation, set-up adjustments, misadjustment of consumer controls, improper maintenance, power line surge, lightning damage, modification, or service by anyone other than a Factory Service center or other Authorized Servicer, or damage that is attributable to acts of God.

THERE ARE NO EXPRESS WARRANTIES EXCEPT AS LISTED UNDER "LIMITED WARRANTY COVERAGE". THE WARRANTOR IS NOT LIABLE FOR INCIDENTAL OR CONSEQUENTIAL DAMAGES RESULTING FROM THE USE OF THIS PRODUCT, OR ARISING OUT OF ANY BREACH OF THIS WARRANTY. (As examples, this excludes damages for lost time, cost of having someone remove or re-install an installed unit if applicable, travel to and from the service, loss of or damage to media or images, data or other recorded content. The items listed are not exclusive, but are for illustration only.)

PARTS AND SERVICE, WHICH ARE NOT COVERED BY THIS LIMITED WARRANTY, ARE YOUR RESPONSIBILITY.