

# User Manual

## **1KVA-5KVA (PF=1) INVERTER / CHARGER**

**Version: 1.1**

# Table Of Contents

<b>ABOUT THIS MANUAL</b> .....	<b>1</b>
Purpose.....	1
Scope.....	1
<b>SAFETY INSTRUCTIONS</b> .....	<b>1</b>
<b>INTRODUCTION</b> .....	<b>2</b>
Features.....	2
Basic System Architecture .....	2
Product Overview.....	3
<b>INSTALLATION</b> .....	<b>4</b>
Unpacking and Inspection.....	4
Preparation .....	4
Mounting the Unit.....	4
Battery Connection .....	5
AC Input/Output Connection.....	7
PV Connection .....	9
Final Assembly.....	11
Communication Connection.....	11
<b>OPERATION</b> .....	<b>12</b>
Power ON/OFF .....	12
Operation and Display Panel .....	12
LCD Display Icons .....	13
LCD Setting.....	15
Display Setting .....	23
Operating Mode Description .....	26
Battery Equalization Description.....	28
Fault Reference Code.....	30
Warning Indicator.....	30
<b>SPECIFICATIONS</b> .....	<b>31</b>
Table 1 Line Mode Specifications .....	31
Table 2 Inverter Mode Specifications .....	32
Table 3 Charge Mode Specifications .....	33
Table 4 General Specifications .....	33
<b>TROUBLE SHOOTING</b> .....	<b>34</b>

# ABOUT THIS MANUAL

## Purpose

This manual describes the assembly, installation, operation and troubleshooting of this unit. Please read this manual carefully before installations and operations. Keep this manual for future reference.

## Scope

This manual provides safety and installation guidelines as well as information on tools and wiring.

# SAFETY INSTRUCTIONS



**WARNING: This chapter contains important safety and operating instructions. Read and keep this manual for future reference.**

1. Before using the unit, read all instructions and cautionary markings on the unit, the batteries and all appropriate sections of this manual.
2. **CAUTION** --To reduce risk of injury, charge only deep-cycle lead acid type rechargeable batteries. Other types of batteries may burst, causing personal injury and damage.
3. Do not disassemble the unit. Take it to a qualified service center when service or repair is required. Incorrect re-assembly may result in a risk of electric shock or fire.
4. To reduce risk of electric shock, disconnect all wirings before attempting any maintenance or cleaning. Turning off the unit will not reduce this risk.
5. **CAUTION** – Only qualified personnel can install this device with battery.
6. **NEVER** charge a frozen battery.
7. For optimum operation of this inverter/charger, please follow required spec to select appropriate cable size. It's very important to correctly operate this inverter/charger.
8. Be very cautious when working with metal tools on or around batteries. A potential risk exists to drop a tool to spark or short circuit batteries or other electrical parts and could cause an explosion.
9. Please strictly follow installation procedure when you want to disconnect AC or DC terminals. Please refer to INSTALLATION section of this manual for the details.
10. One piece of 150A fuse is provided as over-current protection for the battery supply.
11. GROUNDING INSTRUCTIONS -This inverter/charger should be connected to a permanent grounded wiring system. Be sure to comply with local requirements and regulation to install this inverter.
12. NEVER cause AC output and DC input short circuited. Do NOT connect to the mains when DC input short circuits.
13. **Warning!!** Only qualified service persons are able to service this device. If errors still persist after following troubleshooting table, please send this inverter/charger back to local dealer or service center for maintenance.

# INTRODUCTION

This is a multi-function inverter/charger, combining functions of inverter, solar charger and battery charger to offer uninterruptible power support with portable size. Its comprehensive LCD display offers user-configurable and easy-accessible button operation such as battery charging current, AC/solar charger priority, and acceptable input voltage based on different applications.

There are two different types of built-in solar chargers: PWM and MPPT solar charger. For the detailed product specification, please consult your local dealers.

## Features

- Pure sine wave inverter
- Configurable input voltage range for home appliances and personal computers via LCD setting
- Configurable battery charging current based on applications via LCD setting
- Configurable AC/Solar Charger priority via LCD setting
- Compatible to mains voltage or generator power
- Auto restart while AC is recovering
- Overload/ Over temperature/ short circuit protection
- Smart battery charger design for optimized battery performance
- Cold start function

## Basic System Architecture

The following illustration shows basic application for this inverter/charger. It also includes following devices to have a complete running system:

- Generator or Utility.
- PV modules

Consult with your system integrator for other possible system architectures depending on your requirements.

This inverter can power all kinds of appliances in home or office environment, including motor-type appliances such as tube light, fan, refrigerator and air conditioner.

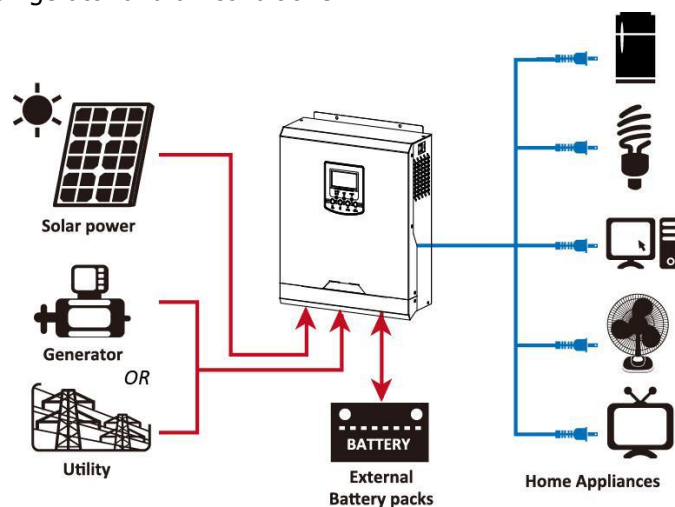
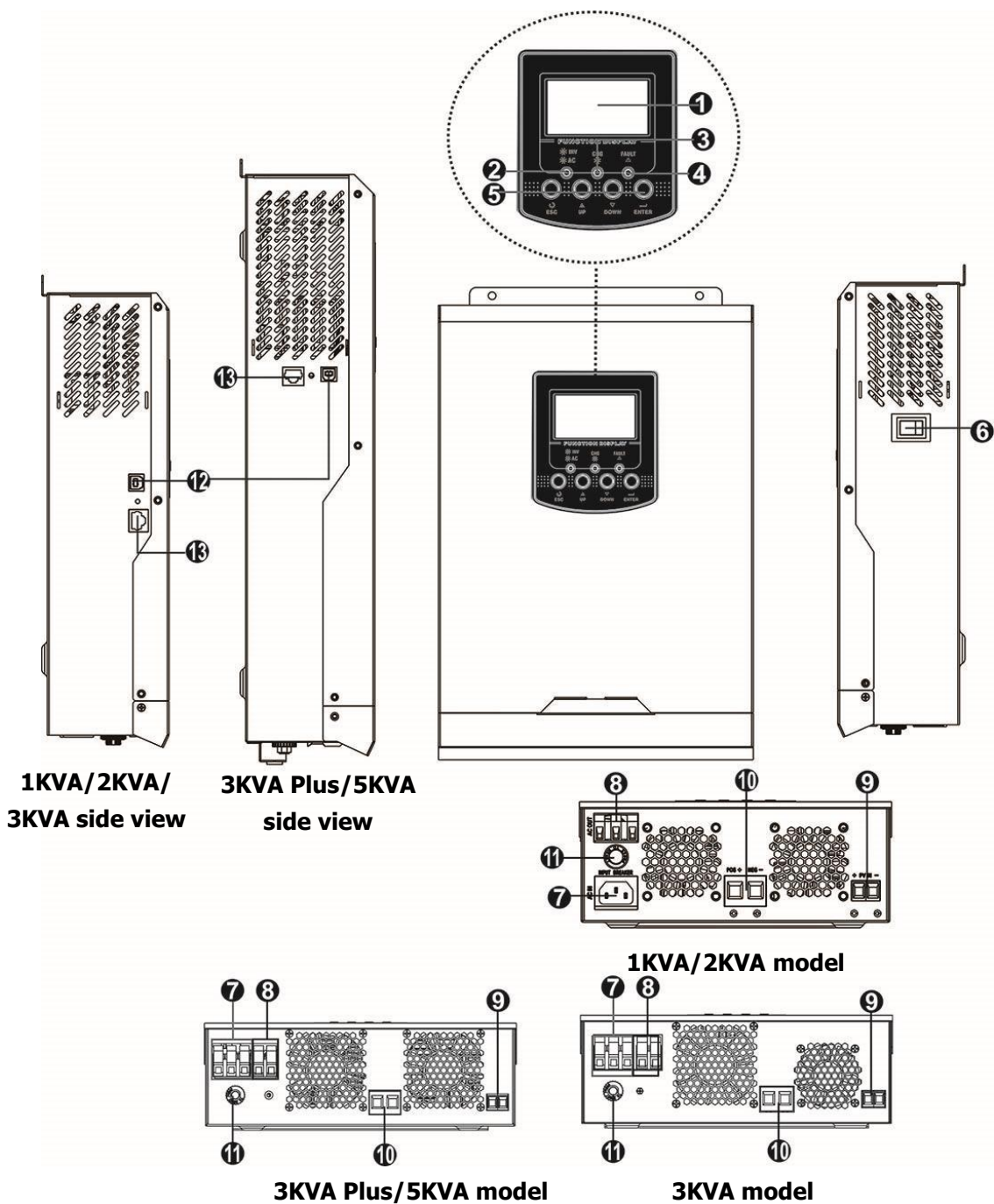

Figure 1 Hybrid Power System

# Product Overview



1. LCD display
2. Status indicator
3. Charging indicator
4. Fault indicator
5. Function buttons
6. Power on/off switch
7. AC input
8. AC output
9. PV input
10. Battery input
11. Circuit breaker
12. USB communication port
13. RS-232 communication port

# INSTALLATION

## Unpacking and Inspection

Before installation, please inspect the unit. Be sure that nothing inside the package is damaged. You should have received the following items inside of package:

- The unit x 1
- User manual x 1
- Communication cable x 1
- Software CD x 1
- DC Fuse x 1
- Ring terminal x 1
- Strain relief plate x 2
- Screws x 4

## Preparation

Before connecting all wirings, please take off bottom cover by removing two screws as shown below.

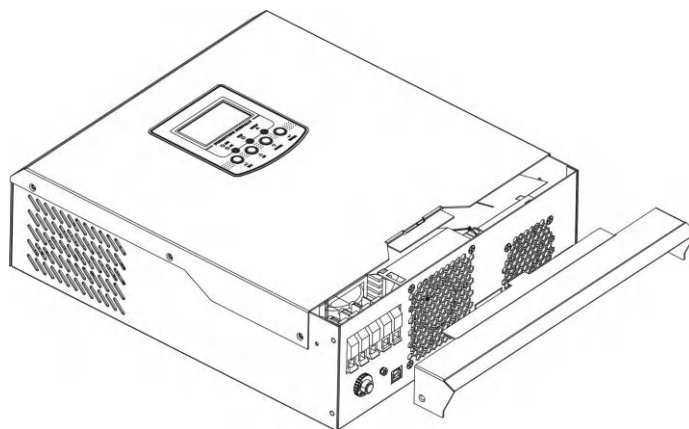

## Mounting the Unit

Consider the following points before selecting where to install:

- Do not mount the inverter on flammable construction materials.
- Mount on a solid surface
- Install this inverter at eye level in order to allow the LCD display to be read at all times.
- For proper air circulation to dissipate heat, allow a clearance of approx. 20 cm to the side and approx. 50 cm above and below the unit.
- The ambient temperature should be between 0°C and 55°C to ensure optimal operation.
- The recommended installation position is to be adhered to the wall vertically.
- Be sure to keep other objects and surfaces as shown in the diagram to guarantee sufficient heat dissipation and to have enough space for removing wires.

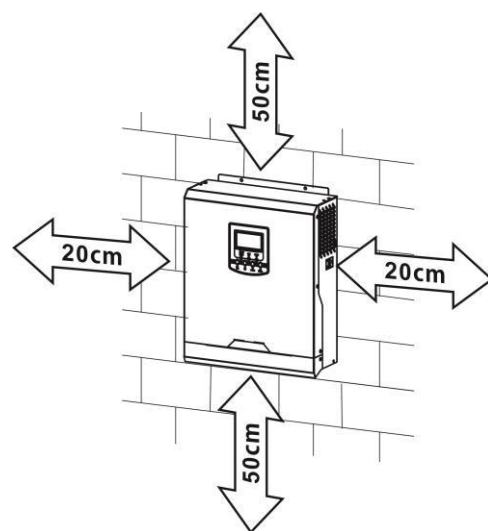

**SUITABLE FOR MOUNTING ON CONCRETE OR OTHER NON-COMBUSTIBLE SURFACE ONLY.**

Install the unit by screwing two screws. It's recommended to use M4 or M5 screws.

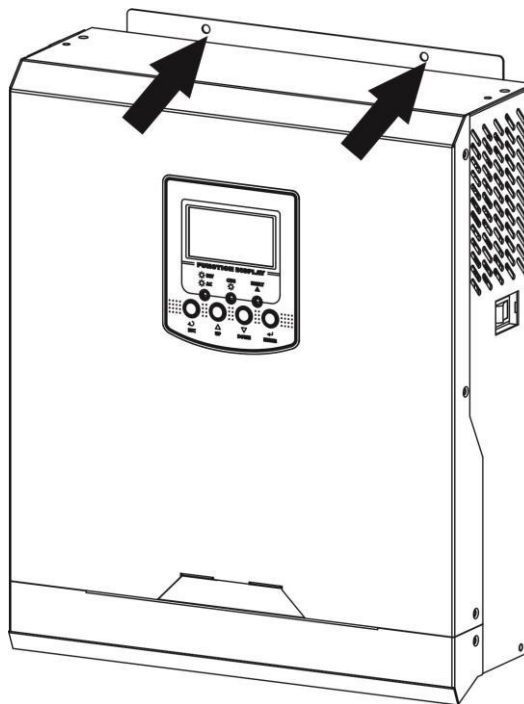

## Battery Connection

**CAUTION:** For safety operation and regulation compliance, it's requested to install a separate DC over-current protector or disconnect device between battery and inverter. It may not be requested to have a disconnect device in some applications, however, it's still requested to have over-current protection installed. Please refer to typical amperage in below table as required fuse or breaker size.

**WARNING!** All wiring must be performed by a qualified personnel.

**WARNING!** It's very important for system safety and efficient operation to use appropriate cable for battery connection. To reduce risk of injury, please use the proper recommended cable as below.

### Recommended battery cable size:

Model	Wire Size	Cable (mm <sup>2</sup> )	Torque value ( max )
1KVA/2KVA	1 x 6AWG	14	2 Nm
3KVA	1 x 4AWG	25	
3KVA Plus/5KVA	1 x 2AWG	35	

Please follow below steps to implement battery connection:

1. Remove insulation sleeve 18 mm for positive and negative conductors.
2. Suggest to put bootlace ferrules on the end of positive and negative wires with a proper crimping tool.
3. Fix strain relief plate to the inverter by supplied screws as shown in below chart.

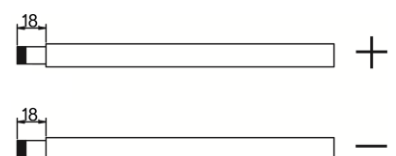

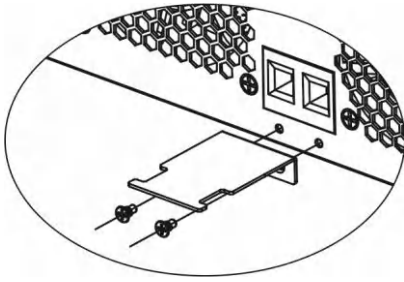

4. 1KVA model supports 12VDC system, 2KVA/3KVA model supports 24VDC system and 5KVA model supports 48VDC system. Connect all battery packs as below chart. It's suggested to connect at least 100Ah capacity battery for 1-3KVA model and at least 200Ah capacity battery for 5KVA model.

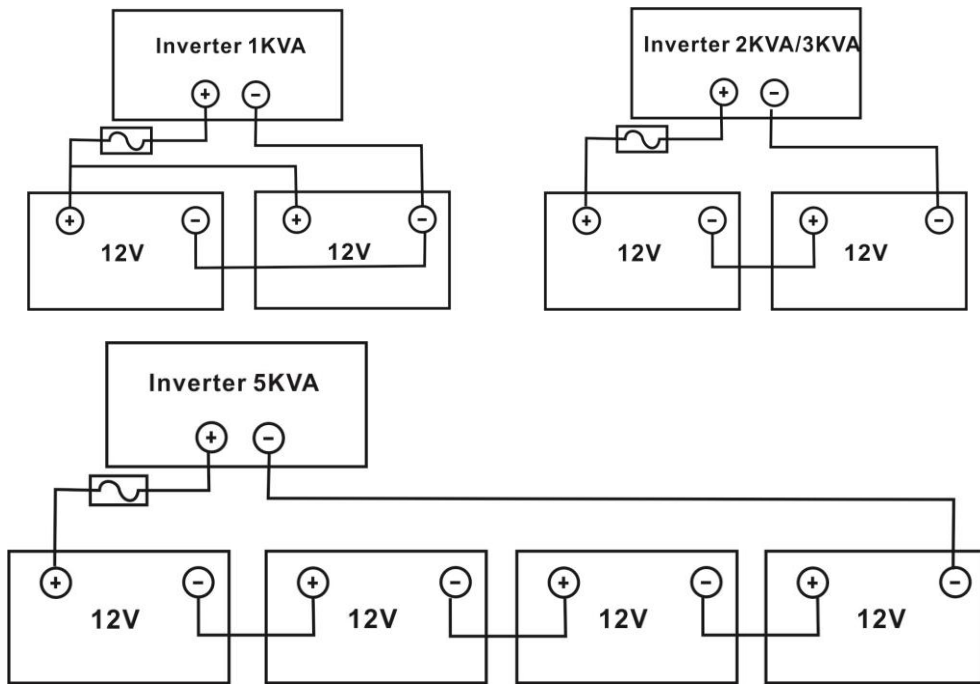

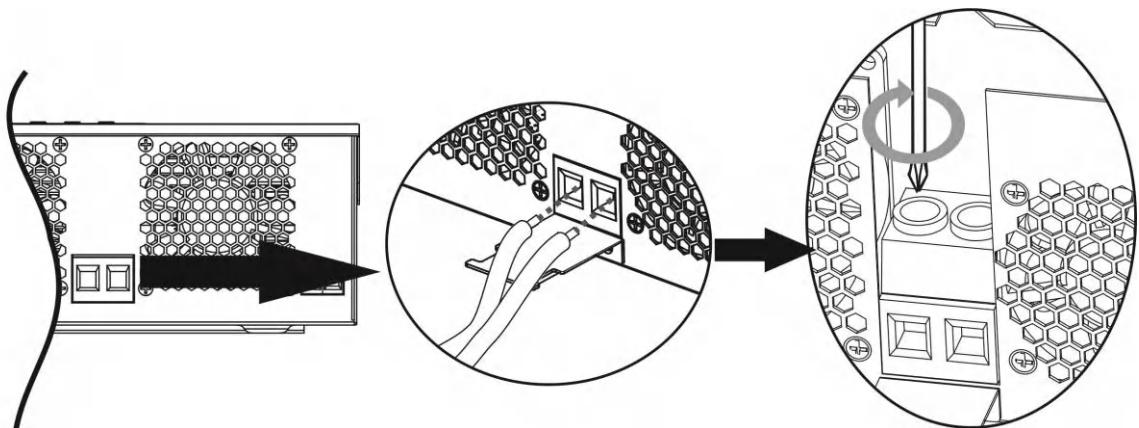

5. Insert the battery wires flatly into battery connectors of inverter and make sure the bolts are tightened with torque of 2 Nm in clockwise direction. Make sure polarity at both the battery and the inverter/charge is correctly connected and conductors are tightly screwed into the battery terminals.  
Recommended tool: #2 Pozi Screwdriver



6. To firmly secure wire connection, you may fix the wires to strain relief with cable tie.

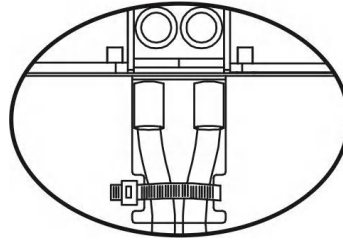



 **WARNING: Shock Hazard**  
Installation must be performed with care due to high battery voltage in series.

 **CAUTION!!** Before making the final DC connection or closing DC breaker/disconnector, be sure positive (+) must be connected to positive (+) and negative (-) must be connected to negative (-).

## AC Input/Output Connection

**CAUTION!!** Before connecting to AC input power source, please install a **separate** AC breaker between inverter and AC input power source. This will ensure the inverter can be securely disconnected during maintenance and fully protected from over current of AC input. The recommended spec of AC breaker is 10A for 1KVA, 20A for 2KVA, 32A for 3KVA/3KVA Plus and 50A for 5KVA.

**CAUTION!!** There are two terminal blocks with "IN" and "OUT" markings. Please do NOT mis-connect input and output connectors.

**WARNING!** All wiring must be performed by a qualified personnel.

**WARNING!** It's very important for system safety and efficient operation to use appropriate cable for AC input connection. To reduce risk of injury, please use the proper recommended cable size as below.

### Suggested cable requirement for AC wires

Model	Gauge	Cable (mm <sup>2</sup> )	Torque Value
1KVA	16 AWG	1.5	0.6 Nm
2KVA	14 AWG	2.5	1.0 Nm
3KVA / 3KVA Plus	12 AWG	4	1.2 Nm
5KVA	10 AWG	6	1.2 Nm

Please follow below steps to implement AC input/output connection:

1. Before making AC input/output connection, be sure to open DC protector or disconnector first.
2. Remove insulation sleeve 10mm for six conductors. And shorten phase L and neutral conductor N 3 mm.
3. For 1KVA/2KVA models, simply connect AC utility to AC input of the inverter with a plug.  
For 3KVA-5KVA models, insert AC input wires according to polarities indicated on terminal block and tighten the terminal screws. Be sure to connect PE protective conductor (  ) first.

 → **Ground (yellow-green)**

**L** → **LINE (brown or black)**

**N** → **Neutral (blue)**

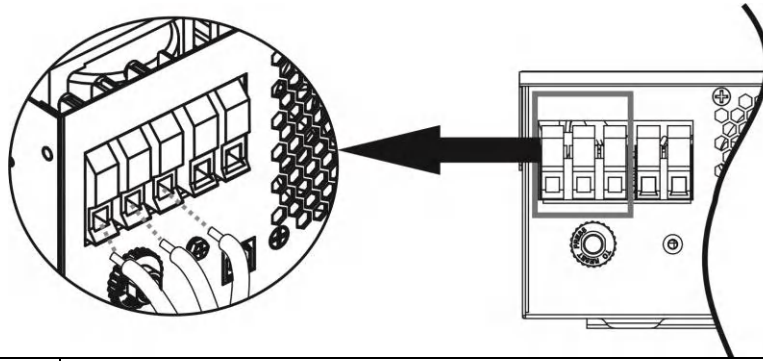

**WARNING:**  
 Be sure that AC power source is disconnected before attempting to hardwire it to the unit.

- Then, insert AC output wires according to polarities indicated on terminal block and tighten terminal screws. Be sure to connect PE protective conductor ( ) first.

→ **Ground (yellow-green)**  
**L** → **LINE (brown or black)**  
**N** → **Neutral (blue)**

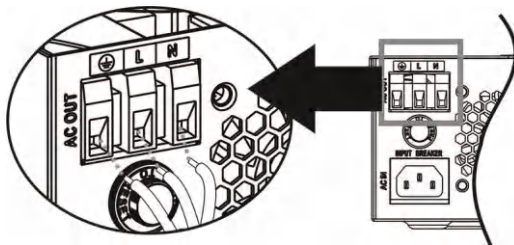

**1KVA/2KVA**

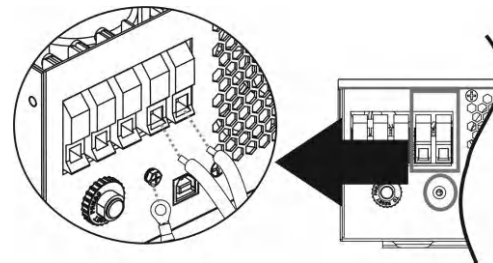

**3KVA/5KVA**

- Make sure the wires are securely connected.

**CAUTION:** Appliances such as air conditioner are required at least 2~3 minutes to restart because it's required to have enough time to balance refrigerant gas inside of circuits. If a power shortage occurs and recovers in a short time, it will cause damage to your connected appliances. To prevent this kind of damage, please check manufacturer of air conditioner if it's equipped with time-delay function before installation. Otherwise, this inverter/charger will trig overload fault and cut off output to protect your appliance but sometimes it still causes internal damage to the air conditioner.

## PV Connection

**CAUTION:** Before connecting to PV modules, please install **separately** a DC circuit breaker between inverter and PV modules.

**WARNING!** It's very important for system safety and efficient operation to use appropriate cable for PV module connection. To reduce risk of injury, please use the proper recommended cable size as below.

Model	Wire Size	Cable (mm <sup>2</sup> )	Torque value ( max )
1KVA/2KVA/3KVA	1 x 8AWG	10	1.6 Nm
3KVA Plus/5KVA			

### PV Module Selection: (Only for the model with PWM solar charger)

When selecting proper PV modules, please be sure to consider below requirements first:

- Open circuit Voltage (Voc) of PV modules not exceeds max. PV array open circuit voltage of inverter.

Charging Current (PWM)	50Amp		
System DC Voltage	12Vdc	24Vdc	48Vdc
Operating Voltage Range	15~18Vdc	30~32Vdc	60~72vdc
Max. PV Array Open Circuit Voltage	55Vdc	80Vdc	105Vdc

- Max. Power Voltage (Vmpp) of PV modules should be close to best Vmp of inverter or within Vmp range to get best performance. If one PV module cannot meet this requirement, it's necessary to have several PV modules in series connection.

**Maximum PV module numbers in Series:**  $V_{mpp}$  of PV module \* X pcs  $\approx$  Best Vmp of Inverter or Vmp range

**PV module numbers in Parallel:** Max. charging current of inverter /  $I_{mpp}$

**Total PV module numbers = maximum PV module numbers in series \* PV module numbers in parallel**

Take 1KVA inverter as an example to select proper PV modules. After considering Voc of PV module not exceeds 50Vdc and max. Vmpp of PV module close to 15Vdc or within 13Vdc ~ 18Vdc, we can choose PV module with below specification.

Maximum Power (Pmax)	85W	Max. PV module numbers in series 1 $\rightarrow$ 17.6 x 1 $\approx$ 15 ~ 18
Max. Power Voltage Vmpp(V)	17.6V	
Max. Power Current Impp(A)	4.83A	PV module numbers in parallel 10 $\rightarrow$ 50 A / 4.83
Open Circuit Voltage Voc(V)	21.6V	
Short Circuit Current Isc(A)	5.03A	Total PV module numbers 1 x 10 = 10

**Maximum PV module numbers in Series: 1**

**PV module numbers in Parallel: 10**

**Total PV module numbers: 1 x 10 = 10**

Take 2KVA/3KVA model inverter as an example to select proper PV module. After considering Voc of PV module not exceed 80Vdc and max. Vmpp of PV module close to 30Vdc or within 30Vdc ~ 32Vdc, we can choose PV module with below specification.

Maximum Power (Pmax)	260W	Max. PV module numbers in series 1 $\rightarrow$ 30.9 x 1 $\approx$ 30 ~ 32
Max. Power Voltage Vmpp(V)	30.9V	
Max. Power Current Impp(A)	8.42A	PV module numbers in parallel 6 $\rightarrow$ 50 A / 8.42
Open Circuit Voltage Voc(V)	37.7V	
Short Circuit Current Isc(A)	8.89A	Total PV module numbers 1 x 6 = 6

**Maximum PV module numbers in Series: 1**

**PV module numbers in Parallel: 6**

**Total PV module numbers: 1 x 6 = 6**

Take 5KVA model inverter as an example to select proper PV module. After considering Voc of PV module not exceed 105Vdc and max. Vmpp of PV module close to 60Vdc or within 56Vdc ~ 72Vdc, we can choose PV module with below specification.

Maximum Power (Pmax)	260W	Max. PV module numbers in series 2 → 30.9 x 2 ≈ 56 ~ 72
Max. Power Voltage Vmpp(V)	30.9V	
Max. Power Current Impp(A)	8.42A	PV module numbers in parallel 6 → 50 A / 8.42
Open Circuit Voltage Voc(V)	37.7V	
Short Circuit Current Isc(A)	8.89A	Total PV module numbers 2 x 6 = 12

**Maximum PV module numbers in Series: 2**

**PV module numbers in Parallel: 6**

**Total PV module numbers: 2 x 6 = 12**

**PV Module Selection: (Only for the model with MPPT solar charger)**

When selecting proper PV modules, please be sure to consider below parameters:

1. Open circuit Voltage (Voc) of PV modules not exceeds max. PV array open circuit voltage of inverter.
2. Open circuit Voltage (Voc) of PV modules should be higher than min. battery voltage.

<b>INVERTER MODEL</b>	3KVA	3KVA Plus	5KVA
<b>Max. PV Array Open Circuit Voltage</b>	102Vdc	145Vdc	
<b>PV Array MPPT Voltage Range</b>	30~80Vdc	30~115Vdc	60~115Vdc

Take 250Wp PV module as an example. After considering above two parameters, the recommended module configurations for 3KVA, 3KVA Plus and 5KVA are listed as below table.

Maximum Power (Pmax)	250W	3KVA: 2 pieces in serial and 2 sets in parallel. 3KVA Plus: ● 2 pieces in serial and 3 sets in parallel, or ● 3 pieces in serial and 2 sets in parallel. 5KVA: ● 2 pieces in serial and 6 sets in parallel, or ● 3 pieces in serial and 4 sets in parallel
Max. Power Voltage Vmpp(V)	30.1V	
Max. Power Current Impp(A)	8.3A	
Open Circuit Voltage Voc(V)	37.7V	
Short Circuit Current Isc(A)	8.4A	

**PV Module Wire Connection**

Please follow below steps to implement PV module connection:

1. Remove insulation sleeve 10 mm for positive and negative conductors.
2. Suggest to put bootlace ferrules on the end of positive and negative wires with a proper crimping tool.
3. Fix strain relief plate to the inverter with supplied screws as shown in below chart.

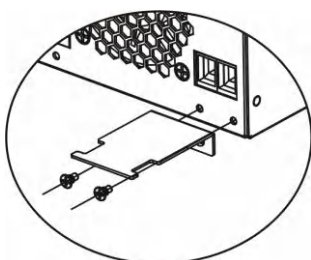
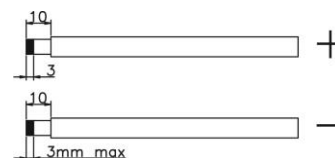

4. Check correct polarity of wire connection from PV modules and PV input connectors. Then, connect positive pole (+) of connection wire to positive pole (+) of PV input connector. Connect negative pole (-) of connection wire to negative pole (-) of PV input connector. Screw two wires tightly in clockwise direction. Recommended tool: 4mm blade screwdriver

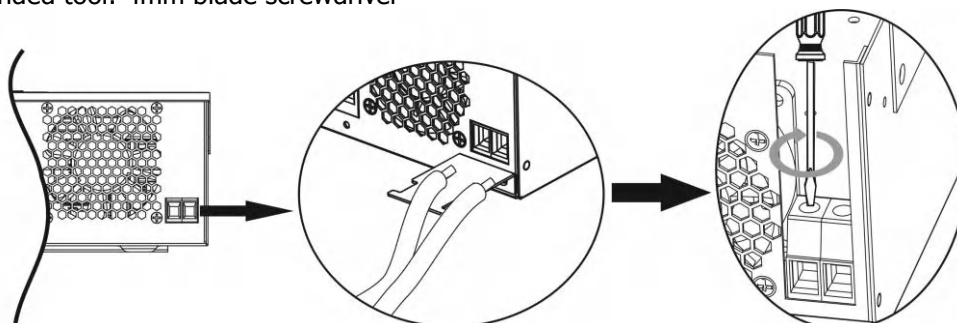

5. To ensure wires are securely connected, you fix wires to the strain relief with cable tie.

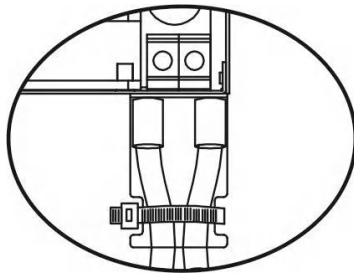

## Final Assembly

After connecting all wirings, please put bottom cover back by screwing two screws as shown below.

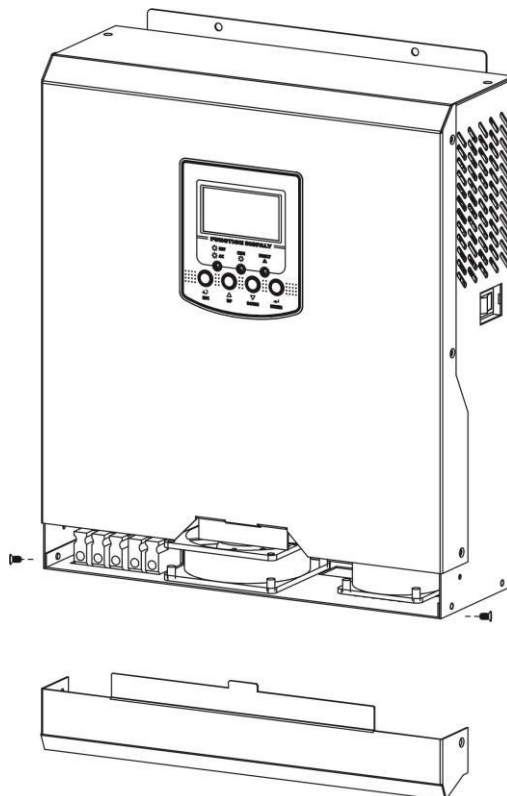

## Communication Connection

Please use supplied communication cable to connect to inverter and PC. Insert bundled CD into a computer and follow on-screen instruction to install the monitoring software. For the detailed software operation, please check user manual of software inside of CD.

# OPERATION

## Power ON/OFF

Side view of unit

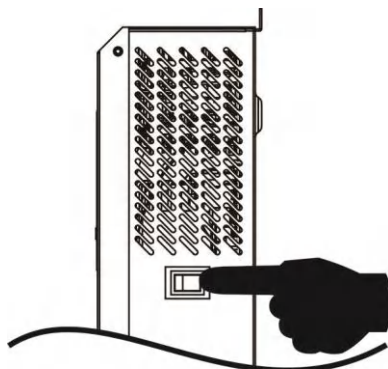

Once the unit has been properly installed and the batteries are connected well, simply press On/Off switch (located on the button of the case) to turn on the unit.

## Operation and Display Panel

The operation and display panel, shown in below chart, is on the front panel of the inverter. It includes three indicators, four function keys and a LCD display, indicating the operating status and input/output power information.

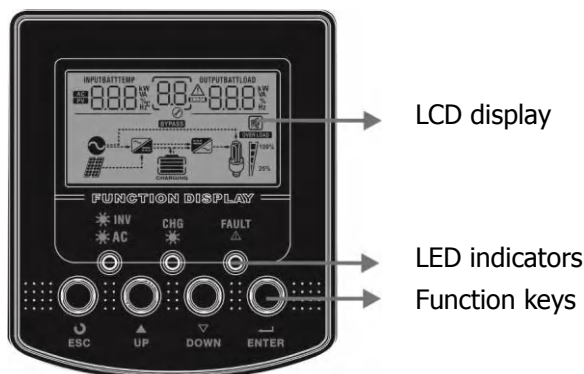

### LED Indicator

LED Indicator		Messages	
☀️ AC / 🔋 INV	Green	Solid On	Output is powered by utility in Line mode.
		Flashing	Output is powered by battery or PV in battery mode.
☀️ CHG	Green	Solid On	Battery is fully charged.
		Flashing	Battery is charging.
⚠️ FAULT	Red	Solid On	Fault occurs in the inverter.
		Flashing	Warning condition occurs in the inverter.

### Function Keys

Function Key	Description
ESC	To exit setting mode
UP	To go to previous selection
DOWN	To go to next selection
ENTER	To confirm the selection in setting mode or enter setting mode

# LCD Display Icons

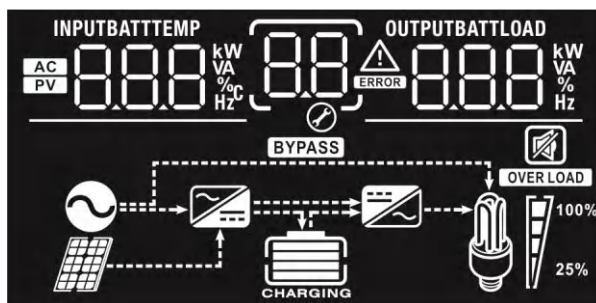

Icon	Function description	
<b>Input Source Information</b>		
<b>AC</b>	Indicates the AC input.	
<b>PV</b>	Indicates the PV input	
<b>INPUTBATT</b> 888 kW VA %C Hz	Indicate input voltage, input frequency, PV voltage, charger current (if PV in charging for 3K models), charger power (only for MPPT models), battery voltage.	
<b>Configuration Program and Fault Information</b>		
88 ⌚	Indicates the setting programs.	
88 ⚠️ ERROR	Indicates the warning and fault codes. Warning: 88 ⚠️ flashing with warning code. Fault: 88 ERROR lighting with fault code	
<b>Output Information</b>		
<b>OUTPUTBATTLOAD</b> 888 kW VA % Hz	Indicate output voltage, output frequency, load percent, load in VA, load in Watt and discharging current.	
<b>Battery Information</b>		
	Indicates battery level by 0-24%, 25-49%, 50-74% and 75-100% in battery mode and charging status in line mode.	
In AC mode, it will present battery charging status.		
Status	Battery voltage	LCD Display
Constant Current mode / Constant Voltage mode	<2V/cell	4 bars will flash in turns.
	2 ~ 2.083V/cell	Bottom bar will be on and the other three bars will flash in turns.
	2.083 ~ 2.167V/cell	Bottom two bars will be on and the other two bars will flash in turns.
Floating mode. Batteries are fully charged.	> 2.167 V/cell	Bottom three bars will be on and the top bar will flash.
		4 bars will be on.

In battery mode, it will present battery capacity.

Load Percentage	Battery Voltage	LCD Display
Load > 50%	< 1.85V/cell	
	1.85V/cell ~ 1.933V/cell	
	1.933V/cell ~ 2.017V/cell	
	> 2.017V/cell	
Load < 50%	< 1.892V/cell	
	1.892V/cell ~ 1.975V/cell	
	1.975V/cell ~ 2.058V/cell	
	> 2.058V/cell	

### Load Information

	Indicates overload.			
	Indicates the load level by 0-24%, 25-49%, 50-74% and 75-100%.			
	0%~24%	25%~49%	50%~74%	75%~100%

### Mode Operation Information

	Indicates unit connects to the mains.
	Indicates unit connects to the PV panel.
	Indicates load is supplied by utility power.
	Indicates the utility charger circuit is working.
	Indicates the DC/AC inverter circuit is working.

### Mute Operation

	Indicates unit alarm is disabled.
--	-----------------------------------



## LCD Setting

After pressing and holding ENTER button for 3 seconds, the unit will enter setting mode. Press "UP" or "DOWN" button to select setting programs. And then, press "ENTER" button to confirm the selection or ESC button to exit.

### Setting Programs:

Program	Description	Selectable option	
00	Exit setting mode	Escape 00 ESC	
01	Output source priority: To configure load power source priority	Solar first 01 SOL	
		Utility first (default) 01 UTI	
		SBU priority 01 SBU	
02	Maximum charging current: To configure total charging current for solar and utility chargers. (Max. charging current = utility charging current + solar charging current)	Available options in 1KVA/2KVA model:	
		10A 02 10 <sup>A</sup>	20A 02 20 <sup>A</sup>
		30A 02 30 <sup>A</sup>	40A 02 40 <sup>A</sup>
		50A (default) 02 50 <sup>A</sup>	

02	Maximum charging current: To configure total charging current for solar and utility chargers. (Max. charging current = utility charging current + solar charging current)	Available options in 3KVA model:	
		20A 02 20 <sup>A</sup>	30A 02 30 <sup>A</sup>
		40A (default for MPPT model) 02 40 <sup>A</sup>	50A (default for PWM model) 02 50 <sup>A</sup>
		60A 02 60 <sup>A</sup>	70A (only for PWM model) 02 70 <sup>A</sup>
		Available options in 3KVA Plus/5KVA model:	
		10A 02 10 <sup>A</sup>	20A 02 20 <sup>A</sup>
		30A 02 30 <sup>A</sup>	40A 02 40 <sup>A</sup>
		50A (default for PWM model) 02 50 <sup>A</sup>	60A (default for MPPT model) 02 60 <sup>A</sup>
		70A 02 70 <sup>A</sup>	80A 02 80 <sup>A</sup>
		90A 02 90 <sup>A</sup>	100A 02 100 <sup>A</sup>
		110A 02 110 <sup>A</sup>	120A (Only for MPPT model) 02 120 <sup>A</sup>
		03	AC input voltage range
UPS 03 UPS	If selected, acceptable AC input voltage range will be within 170-280VAC.		
05	Battery type	AGM (default) 05 AGM	Flooded 05 FLd
		User-Defined 05 USE	If "User-Defined" is selected, battery charge voltage and low DC cut-off voltage can be set up in program 26, 27 and 29.
06	Auto restart when overload occurs	Restart disable 06 Lfd (default)	Restart enable 06 LfE





07	Auto restart when over temperature occurs	Restart disable 07 6Fd (default)	Restart enable 07 6FE
09	Output frequency	50Hz (default) 09 50 Hz	60Hz 09 60 Hz
11	<p>Maximum utility charging current</p> <p>Note: If setting value in program 02 is smaller than that in program in 11, the inverter will apply charging current from program 02 for utility charger.</p>	Available options in 1KVA/2KVA model:	
		10A 11 10A	20A (default) 11 20A
		Available options in 3KVA model:	
		15A 11 15A	25A (default) 11 25A
		Available options in 3KVA Plus/5KVA model:	
		2A 11 2A	10A 11 10A
		20A 11 20A	30A (default) 11 30A
		40A 11 40A	50A 11 50A
	60A 11 60A		
12	Setting voltage point back to utility source when selecting "SBU priority" or "Solar first" in program 01.	Available options in 1KVA model:	
		11.0V 12 BATT 11.0 v	11.3V 12 BATT 11.3 v
		11.5V (default) 12 BATT 11.5 v	11.8V 12 BATT 11.8 v
		12.0V 12 BATT 12.0 v	12.3V 12 BATT 12.3 v
		12.5V 12 BATT 12.5 v	12.8V 12 BATT 12.8 v

12	Setting voltage point back to utility source when selecting "SBU priority" or "Solar first" in program 01.	Available options in 2KVA/3KVA/3KVA Plus model:	
		22.0V 12 <sup>BATT</sup> 22.0 <sub>v</sub>	22.5V 12 <sup>BATT</sup> 22.5 <sub>v</sub>
		23.0V (default) 12 <sup>BATT</sup> 23.0 <sub>v</sub>	23.5V 12 <sup>BATT</sup> 23.5 <sub>v</sub>
		24.0V 12 <sup>BATT</sup> 24.0 <sub>v</sub>	24.5V 12 <sup>BATT</sup> 24.5 <sub>v</sub>
		25.0V 12 <sup>BATT</sup> 25.0 <sub>v</sub>	25.5V 12 <sup>BATT</sup> 25.5 <sub>v</sub>
		Available options in 5KVA model:	
		44V 12 <sup>BATT</sup> 44 <sub>v</sub>	45V 12 <sup>BATT</sup> 45 <sub>v</sub>
		46V (default) 12 <sup>BATT</sup> 46 <sub>v</sub>	47V 12 <sup>BATT</sup> 47 <sub>v</sub>
		48V 12 <sup>BATT</sup> 48 <sub>v</sub>	49V 12 <sup>BATT</sup> 49 <sub>v</sub>
		50V 12 <sup>BATT</sup> 50 <sub>v</sub>	51V 12 <sup>BATT</sup> 51 <sub>v</sub>
13	Setting voltage point back to battery mode when selecting "SBU priority" or "Solar first" in program 01.	Available options in 1KVA model:	
		Battery fully charged 13 <sup>BATT</sup> FUL	12.0V 13 <sup>BATT</sup> 12.0 <sub>v</sub>
		12.3V 13 <sup>BATT</sup> 12.3 <sub>v</sub>	12.5V 13 <sup>BATT</sup> 12.5 <sub>v</sub>
		12.8V 13 <sup>BATT</sup> 12.8 <sub>v</sub>	13.0V 13 <sup>BATT</sup> 13.0 <sub>v</sub>

13	Setting voltage point back to battery mode when selecting "SBU priority" or "Solar first" in program 01.	13.3V 	13.5V (default) 
		13.8V 	14.0V 
		14.3V 	14.5V 
		Available options in 2KVA/3KVA/3KVA Plus model:	
		Battery fully charged 	24V 
		24.5V 	25V 
		25.5V 	26V 
		26.5V 	27V (default) 
		27.5V 	28V 
		28.5V 	29V 
		Available options in 5KVA model:	
		Battery fully charged 	48V 
		49V 	50V 

13	Setting voltage point back to battery mode when selecting "SBU priority" or "Solar first" in program 01.	51V 13 51.0 <sup>BATT</sup> v	52V 13 52.0 <sup>BATT</sup> v
		53V 13 53.0 <sup>BATT</sup> v	54V (default) 13 54.0 <sup>BATT</sup> v
		55V 13 55.0 <sup>BATT</sup> v	56V 13 56.0 <sup>BATT</sup> v
		57V 13 57.0 <sup>BATT</sup> v	58V 13 58.0 <sup>BATT</sup> v
16	Charger source priority: To configure charger source priority	If this inverter/charger is working in Line, Standby or Fault mode, charger source can be programmed as below:	
		Solar first 16 C50	Solar energy will charge battery as first priority. Utility will charge battery only when solar energy is not available.
		Utility first 16 CUE	Utility will charge battery as first priority. Solar energy will charge battery only when utility power is not available.
		Solar and Utility (default) 16 SNU	Solar energy and utility will charge battery at the same time.
		Only Solar 16 O50	Solar energy will be the only charger source no matter utility is available or not.
If this inverter/charger is working in Battery mode or Power saving mode, only solar energy can charge battery. Solar energy will charge battery if it's available and sufficient.			
18	Alarm control	Alarm on (default) 18 60N	Alarm off 18 60F
19	Auto return to default display screen	Return to default display screen (default) 19 ESP	If selected, no matter how users switch display screen, it will automatically return to default display screen (Input voltage /output voltage) after no button is pressed for 1 minute.
		Stay at latest screen 19 FEP	If selected, the display screen will stay at latest screen user finally switches.

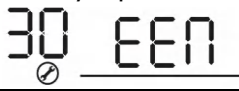
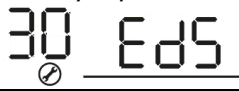
20	Backlight control	Backlight on (default) 20 LON	Backlight off 20 LOF
22	Beeps while primary source is interrupted	Alarm on (default) 22 AON	Alarm off 22 AOF
23	Overload bypass: When enabled, the unit will transfer to line mode if overload occurs in battery mode.	Bypass disable (default) 23 byd	Bypass enable 23 byE
25	Record Fault code	Record enable (default) 25 FEN	Record disable 25 FdS
26	Bulk charging voltage (C.V voltage)	1KVA default setting: 14.1V CU 26 BATT 14.1v	
		2KVA/3KVA/3KVA Plus default setting: 28.2V CU 26 BATT 28.2v	
		5KVA default setting: 56.4V CU 26 BATT 56.4v	
		If self-defined is selected in program 5, this program can be set up. Setting range is from 12.5V to 15.0V for 1K model, 25.0V to 30.0V for 2KVA model, 25.0V to 31.5V for 3KVA/3KVA Plus model and 48.0V to 61.0V for 5KVA model. Increment of each click is 0.1V.	
27	Floating charging voltage	1KVA default setting: 13.5V FLU 27 BATT 13.5v	
		2KVA/3KVA/3KVA Plus default setting: 27.0V FLU 27 BATT 27.0v	
		5KVA default setting: 54.0V FLU 27 BATT 54.0v	
		If self-defined is selected in program 5, this program can be set up. Setting range is from 12.5V to 15.0V for 1K model, 25.0V to 30.0V for 2KVA model, 25.0V to 31.5V for 3KVA/3KVA Plus model and 48.0V to 61.0V for 5KVA model. Increment of each click is 0.1V.	

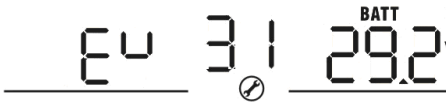
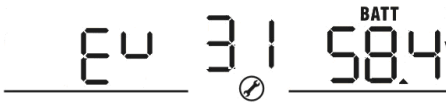
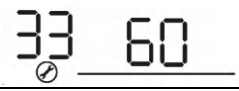
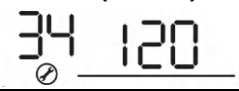
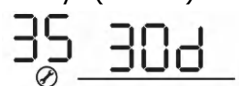
29	Low DC cut-off voltage	1KVA default setting: 10.5V 	
		2KVA/3KVA/3KVA Plus default setting: 21.0V 	
		5KVA default setting: 42.0V 	
		If self-defined is selected in program 5, this program can be set up. Setting range is from 10.5V to 12.0V for 1K model, 21.0V to 24.0V for 2KVA/3KVA/3KVA Plus model and 42.0V to 48.0V for 5KVA model. Increment of each click is 0.1V. Low DC cut-off voltage will be fixed to setting value no matter what percentage of load is connected.	
30	Battery equalization	Battery equalization 	Battery equalization disable (default) 
		If "Flooded" or "User-Defined" is selected in program 05, this program can be set up.	
31	Battery equalization voltage	1KVA default setting: 14.6V 	
		2KVA/3KVA/3KVA Plus default setting: 29.2V 	
		5KVA default setting: 58.4V 	
		Setting range is from 12.5V to 15.0V for 1KVA model, 25.0V to 30.0V for 2KVA model, 25.0V to 31.5V for 3KVA/3KVA Plus model and 48.0V to 61.0V for 5KVA model. Increment of each click is 0.1V.	
33	Battery equalized time	60min (default) 	Setting range is from 5min to 900min. Increment of each click is 5min.
34	Battery equalized timeout	120min (default) 	Setting range is from 5min to 900 min. Increment of each click is 5 min.
35	Equalization interval	30days (default) 	Setting range is from 0 to 90 days. Increment of each click is 1 day



36	Equalization activated immediately	Enable	36 AEN	Disable (default)	36 AdS
		<p>If equalization function is enabled in program 30, this program can be set up. If "Enable" is selected in this program, it's to activate battery equalization immediately and LCD main page will shows "E9". If "Disable" is selected, it will cancel equalization function until next activated equalization time arrives based on program 35 setting. At this time, "E9" will not be shown in LCD main page.</p>			

## Display Setting





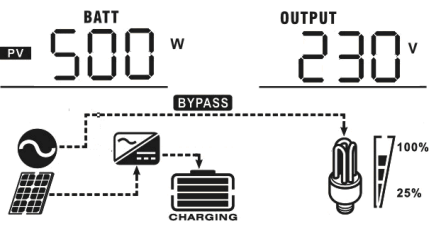
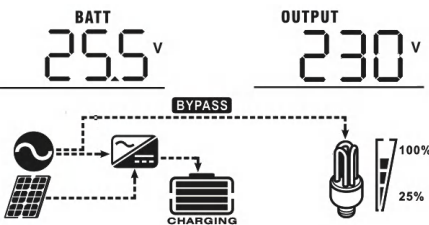
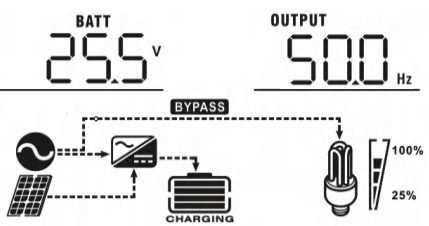
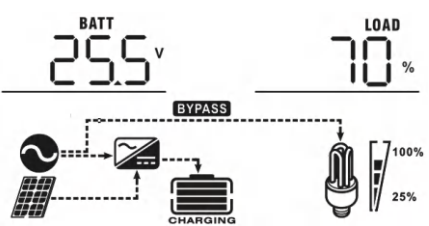
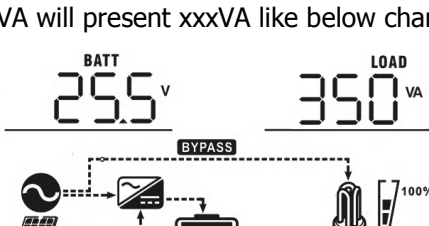
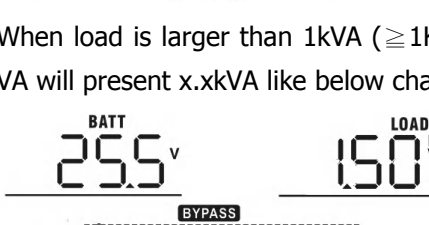

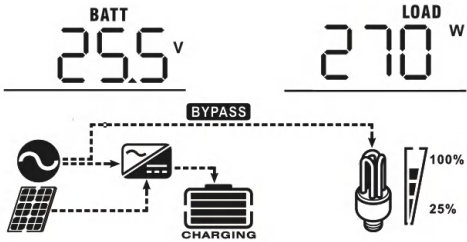
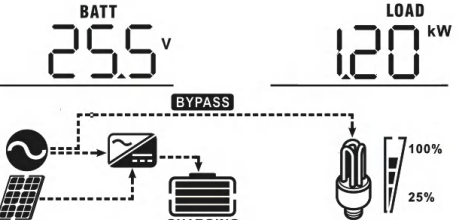
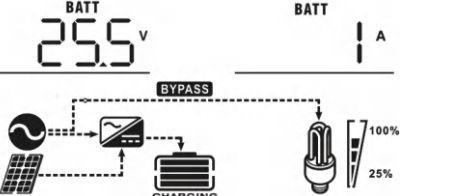
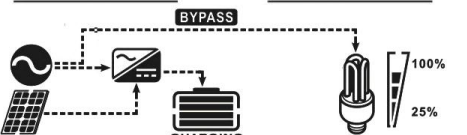
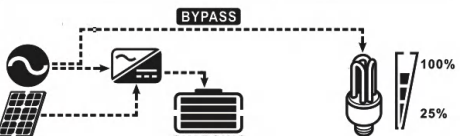

The LCD display information will be switched in turns by pressing "UP" or "DOWN" key. The selectable information is switched as below order: input voltage, input frequency, PV voltage, charging current, charging power (only for MPPT models), battery voltage, output voltage, output frequency, load percentage, load in Watt, load in VA, load in Watt, DC discharging current, main CPU Version and second CPU Version.



Selectable information	LCD display
Input voltage/Output voltage (Default Display Screen)	<p>Input Voltage=230V, output voltage=230V</p>
Input frequency	<p>Input frequency=50Hz</p>
PV voltage	<p>PV voltage=60V</p>
Charging current	<p>Charging current=50A</p>

Charging power (only for MPPT model)	<p>MPPT charging power=500W</p> 
Battery voltage and output voltage	<p>Battery voltage=25.5V, output voltage=230V</p> 
Output frequency	<p>Output frequency=50Hz</p> 
Load percentage	<p>Load percent=70%</p> 
Load in VA	<p>When connected load is lower than 1kVA, load in VA will present xxxVA like below chart.</p>  <p>When load is larger than 1kVA (<math>\geq 1\text{kVA}</math>), load in VA will present x.xkVA like below chart.</p> 

<p>Load in Watt</p>	<p>When load is lower than 1kW, load in W will present xxxW like below chart.</p>  <p>When load is larger than 1kW (<math>\geq 1\text{KW}</math>), load in W will present x.xkW like below chart.</p> 
<p>Battery voltage/DC discharging current</p>	<p>Battery voltage=25.5V, discharging current=1A</p> 
<p>Main CPU version checking</p>	<p>Main CPU version 00014.04</p> 
<p>Secondary CPU version checking</p>	<p>Secondary CPU version 00003.03</p> 

# Operating Mode Description

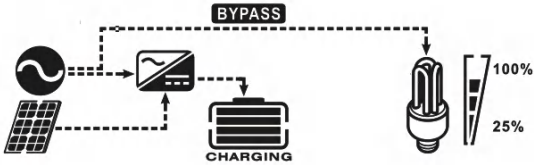
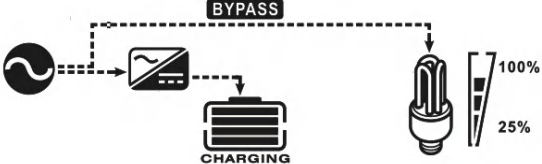
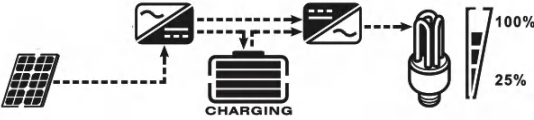
Operation mode	Description	LCD display
<p>Standby mode / Power saving mode</p> <p><b>Note:</b></p> <p>*Standby mode: The inverter is not turned on yet but at this time, the inverter can charge battery without AC output.</p> <p>*Power saving mode: If enabled, the output of inverter will be off when connected load is pretty low or not detected.</p>	<p>No output is supplied by the unit but it still can charge batteries.</p>	<p>Charging by utility and PV energy.</p> 
		<p>Charging by utility.</p> 
		<p>Charging by PV energy.</p> 
		<p>No charging.</p> 
<p>Fault mode</p> <p>Note:</p> <p>*Fault mode: Errors are caused by inside circuit error or external reasons such as over temperature, output short circuited and so on.</p>	<p>PV energy and utility can charge batteries.</p>	<p>Charging by utility and PV energy.</p> 
		<p>Charging by utility.</p> 
		<p>Charging by PV energy.</p> 
		<p>No charging.</p> 

Operation mode	Description	LCD display
Line Mode	The unit will provide output power from the mains. It will also charge the battery at line mode.	Charging by utility and PV energy. 
		Charging by utility. 
Battery Mode	The unit will provide output power from battery and PV power.	Power from battery and PV energy. 
		Power from battery only. 

# Battery Equalization Description

Equalization function is added into charge controller. It reverses the buildup of negative chemical effects like stratification, a condition where acid concentration is greater at the bottom of the battery than at the top. Equalization also helps to remove sulfate crystals that might have built up on the plates. If left unchecked, this condition, called sulfation, will reduce the overall capacity of the battery. Therefore, it's recommended to equalize battery periodically.

- **How to Apply Equalization Function**

You must enable battery equalization function in monitoring LCD setting program 30 first. Then, you may apply this function in device by either one of following methods:

1. Setting equalization interval in program 35.
2. Active equalization immediately in program 36.

- **When to Equalize**

In float stage, when the setting equalization interval (battery equalization cycle) is arrived, or equalization is active immediately, the controller will start to enter Equalize stage.

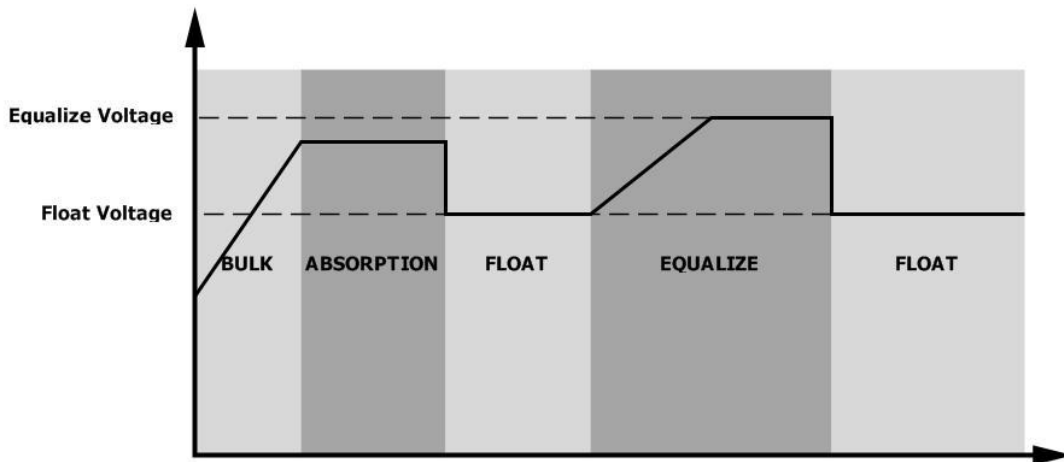

- **Equalize charging time and timeout**

In Equalize stage, the controller will supply power to charge battery as much as possible until battery voltage raises to battery equalization voltage. Then, constant-voltage regulation is applied to maintain battery voltage at the battery equalization voltage. The battery will remain in the Equalize stage until setting battery equalized time is arrived.

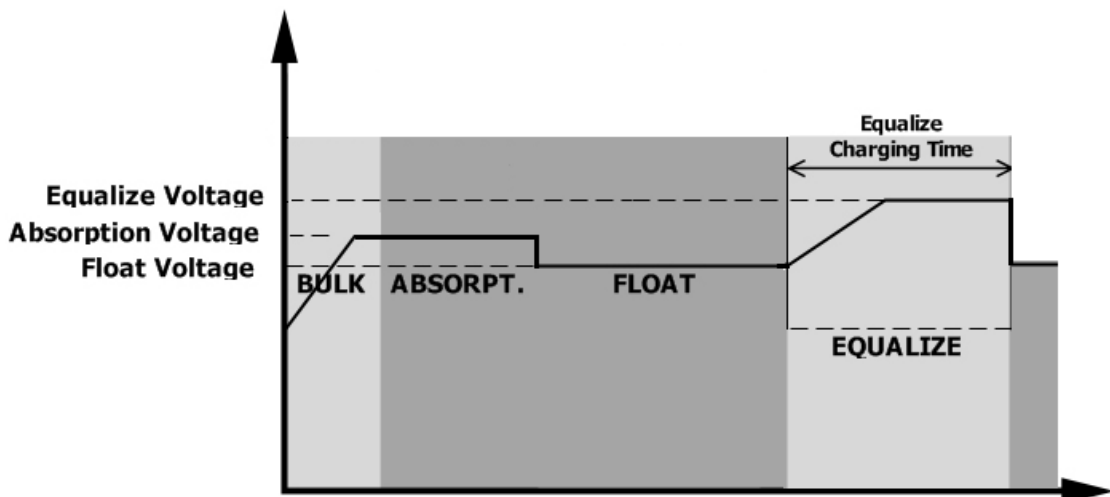

However, in Equalize stage, when battery equalized time is expired and battery voltage doesn't rise to battery equalization voltage point, the charge controller will extend the battery equalized time until battery voltage achieves battery equalization voltage. If battery voltage is still lower than battery equalization voltage when battery equalized timeout setting is over, the charge controller will stop equalization and return to float stage.

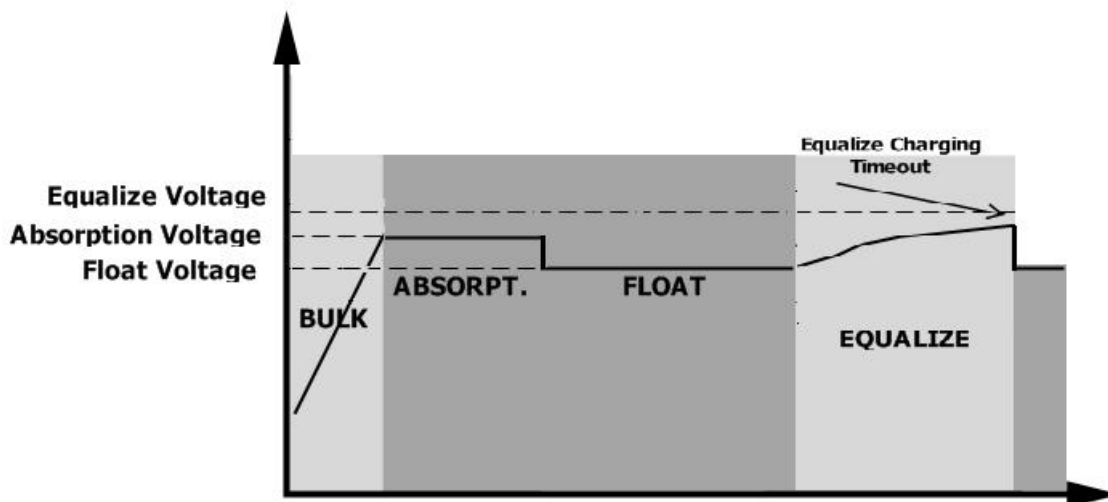

## Fault Reference Code

Fault Code	Fault Event	Icon on
01	Fan is locked when inverter is off.	
02	Over temperature	
03	Battery voltage is too high	
04	Battery voltage is too low	
05	Output short circuited or over temperature is detected by internal converter components.	
06	Output voltage is abnormal. (For 3KVA model) Output voltage is too high. (For 3KVA Plus/5KVA model)	
07	Overload time out	
08	Bus voltage is too high	
09	Bus soft start failed	
51	Over current or surge	
52	Bus voltage is too low	
53	Inverter soft start failed	
55	Over DC voltage in AC output	
56	Battery connection is open	
57	Current sensor failed	
58	Output voltage is too low	

**NOTE: Fault codes 51, 52, 53, 55, 56, 57 and 58 are only available in 3KVA Plus/5KVA model.**

## Warning Indicator

Warning Code	Warning Event	Audible Alarm	Icon flashing
01	Fan is locked when inverter is on.	Beep three times every second	
03	Battery is over-charged	Beep once every second	
04	Low battery	Beep once every second	
07	Overload	Beep once every 0.5 second	
10	Output power derating	Beep twice every 3 seconds	
59	Battery equalization	None	



# SPECIFICATIONS

Table 1 Line Mode Specifications

INVERTER MODEL	1KVA	2KVA	3KVA	3KVA Plus	5KVA
<b>Input Voltage Waveform</b>	Sinusoidal (utility or generator)				
<b>Nominal Input Voltage</b>	230Vac				
<b>Low Loss Voltage</b>	170Vac±7V (UPS); 90Vac±7V (Appliances)				
<b>Low Loss Return Voltage</b>	180Vac±7V (UPS); 100Vac±7V (Appliances)				
<b>High Loss Voltage</b>	280Vac±7V				
<b>High Loss Return Voltage</b>	270Vac±7V				
<b>Max AC Input Voltage</b>	300Vac				
<b>Nominal Input Frequency</b>	50Hz / 60Hz (Auto detection)				
<b>Low Loss Frequency</b>	40±1Hz				
<b>Low Loss Return Frequency</b>	42±1Hz				
<b>High Loss Frequency</b>	65±1Hz				
<b>High Loss Return Frequency</b>	63±1Hz				
<b>Output Short Circuit Protection</b>	Circuit Breaker				
<b>Efficiency (Line Mode)</b>	>95% ( Rated R load, battery full charged )				
<b>Transfer Time</b>	10ms typical (UPS); 20ms typical (Appliances)				
<p><b>Output power derating:</b> When AC input voltage drops to 170V, the output power will be derated.</p>	<p>The graph illustrates the output power derating characteristics. The vertical axis represents Output Power, with specific levels for 50% Power and Rated Power. The horizontal axis represents Input Voltage, with key points at 90V, 170V, and 280V. The power remains at zero until 90V, then rises to 50% of the rated power. Between 90V and 170V, the power increases linearly to reach the full Rated Power. From 170V to 280V, the inverter maintains its full Rated Power output. Beyond 280V, the output power drops to zero.</p>				

Table 2 Inverter Mode Specifications

INVERTER MODEL	1KVA	2KVA	3KVA	3KVA Plus	5KVA
<b>Rated Output Power</b>	1KVA/1KW	2KVA/2KW	3KVA/3KW		5KVA/5KW
<b>Output Voltage Waveform</b>	Pure Sine Wave				
<b>Output Voltage Regulation</b>	230Vac±5%				
<b>Output Frequency</b>	50Hz				
<b>Peak Efficiency</b>	93%				
<b>Overload Protection</b>	5s@≥150% load; 10s@105%~150% load				
<b>Surge Capacity</b>	2* rated power for 5 seconds				
<b>Nominal DC Input Voltage</b>	12Vdc	24Vdc	24Vdc		48Vdc
<b>Cold Start Voltage</b>	11.5Vdc	23.0Vdc	23.0Vdc		46.0Vdc
<b>Low DC Warning Voltage</b>					
@ load < 50%	11.5Vdc	23.0Vdc	23.0Vdc		46.0Vdc
@ load ≥ 50%	11.0Vdc	22.0Vdc	22.0Vdc		44.0Vdc
<b>Low DC Warning Return Voltage</b>					
@ load < 50%	11.7Vdc	23.5Vdc	23.5Vdc		47.0Vdc
@ load ≥ 50%	11.5Vdc	23.0Vdc	23.0Vdc		46.0Vdc
<b>Low DC Cut-off Voltage</b>					
@ load < 50%	10.7Vdc	21.5Vdc	21.5Vdc		43.0Vdc
@ load ≥ 50%	10.5Vdc	21.0Vdc	21.0Vdc		42.0Vdc
<b>High DC Recovery Voltage</b>	15Vdc	30Vdc	32Vdc		62Vdc
<b>High DC Cut-off Voltage</b>	16Vdc	31Vdc	33Vdc		63Vdc
<b>No Load Power Consumption</b>	<25W				<55W

Table 3 Charge Mode Specifications

Utility Charging Mode					
INVERTER MODEL	1KVA	2KVA	3KVA	3KVA Plus	5KVA
Charging Algorithm	3-Step				
AC Charging Current (Max)	20Amp(@V <sub>I/P</sub> =230Vac)		25Amp (@V <sub>I/P</sub> =230Vac)	60Amp (@V <sub>I/P</sub> =230Vac)	
Bulk Charging Voltage	Flooded Battery	14.6	29.2		58.4
	AGM / Gel Battery	14.1	28.2		56.4
Floating Charging Voltage	13.5Vdc	27Vdc			54Vdc
Charging Curve					
PWM Solar Charging Mode					
INVERTER MODEL	1KVA	2KVA	3KVA	5KVA	
Charging Current	50Amp				
System DC Voltage	12Vdc	24Vdc		48Vdc	
Operating Voltage Range	15~18Vdc	30~32Vdc		60~72Vdc	
Max. PV Array Open Circuit Voltage	55Vdc	80Vdc		105Vdc	
DC Voltage Accuracy	+/-0.3%				
Max Charging Current (AC charger plus solar charger)	50Amp	70Amp		110Amp	
MPPT Solar Charging Mode					
INVERTER MODEL	3KVA		3KVA Plus	5KVA	
Charging Current	40Amp		60Amp		
PV Array MPPT Voltage Range	30~80Vdc		30~115Vdc	60~115Vdc	
Max. PV Array Open Circuit Voltage	102Vdc		145Vdc		
Max Charging Current (AC charger plus solar charger)	60Amp		120Amp		

Table 4 General Specifications

INVERTER MODEL	1KVA	2KVA	3KVA	3KVA Plus	5KVA
Safety Certification	CE				
Operating Temperature Range	-10°C to 50°C				
Storage temperature	-15°C~ 60°C				
Humidity	5% to 95% Relative Humidity (Non-condensing)				
Dimension (D*W*H), mm	88 x 225 x 320	100 x 285 x 334		100 x 300 x 440	
Net Weight, kg (PWM model)	5.0	5.5	6.3	N/A	8.5
Net Weight, kg (MPPT model)	N/A	N/A	6.5	9.5	9.7

# TROUBLE SHOOTING

Problem	LCD/LED/Buzzer	Explanation / Possible cause	What to do
Unit shuts down automatically during startup process.	LCD/LEDs and buzzer will be active for 3 seconds and then complete off.	The battery voltage is too low (<1.91V/Cell)	1. Re-charge battery. 2. Replace battery.
No response after power on.	No indication.	1. The battery voltage is far too low. (<1.4V/Cell) 2. Internal fuse tripped.	1. Contact repair center for replacing the fuse. 2. Re-charge battery. 3. Replace battery.
Mains exist but the unit works in battery mode.	Input voltage is displayed as 0 on the LCD and green LED is flashing.	Input protector is tripped	Check if AC breaker is tripped and AC wiring is connected well.
	Green LED is flashing.	Insufficient quality of AC power. (Shore or Generator)	1. Check if AC wires are too thin and/or too long. 2. Check if generator (if applied) is working well or if input voltage range setting is correct. (UPS→Appliance)
	Green LED is flashing.	Set "Solar First" as the priority of output source.	Change output source priority to Utility first.
When the unit is turned on, internal relay is switched on and off repeatedly.	LCD display and LEDs are flashing	Battery is disconnected.	Check if battery wires are connected well.
Buzzer beeps continuously and red LED is on.	Fault code 07	Overload error. The inverter is overload 105% and time is up.	Reduce the connected load by switching off some equipment.
	Fault code 05	Output short circuited.	Check if wiring is connected well and remove abnormal load.
		Temperature of internal converter component is over 120°C. (Only available for 1-3KVA models)	Check whether the air flow of the unit is blocked or whether the ambient temperature is too high.
	Fault code 02	Internal temperature of inverter component is over 100°C.	
	Fault code 03	Battery is over-charged.	Return to repair center.
		The battery voltage is too high.	Check if spec and quantity of batteries are meet requirements.
	Fault code 01	Fan fault	Replace the fan.
	Fault code 06/58	Output abnormal (Inverter voltage below than 190Vac or is higher than 260Vac)	1. Reduce the connected load. 2. Return to repair center
	Fault code 08/09/53/57	Internal components failed.	Return to repair center.
	Fault code 51	Over current or surge.	Restart the unit, if the error happens again, please return to repair center.
	Fault code 52	Bus voltage is too low.	
Fault code 55	Output voltage is unbalanced.		
Fault code 56	Battery is not connected well or fuse is burnt.	If the battery is connected well, please return to repair center.	