

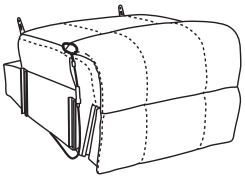

Electric Lift Chair Assembly Instruction

A 	B 	C 	D 	E 	F 	G 
Chair base	Backrest	Left Armrest	Right Armrest	Remote control	Power Source	Anti-fall bracket x2

STEP 1

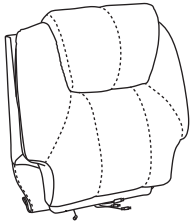
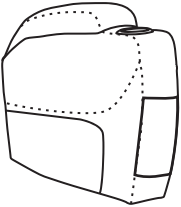
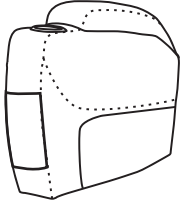

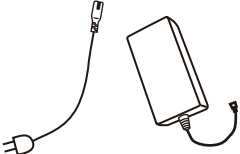
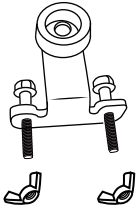
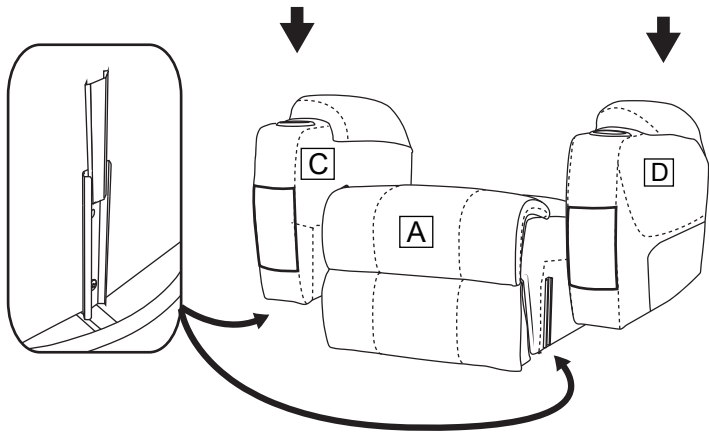
Insert two armrests to the chair base, make sure the slots on the armrests fully assembled to the bottom part.

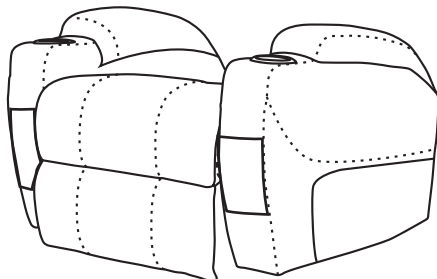

STEP 2

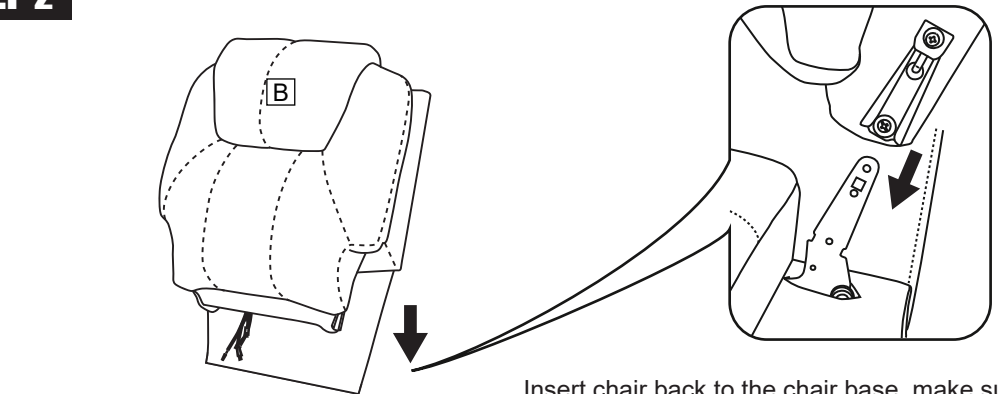

Insert chair back to the chair base, make sure the slots on the back fully assembled to the bottom part.

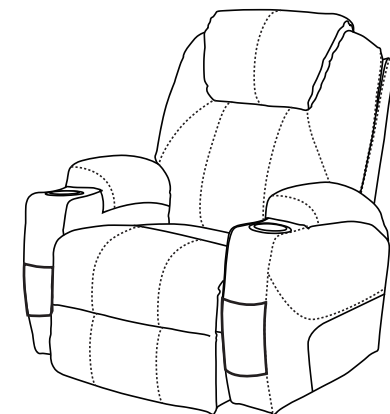
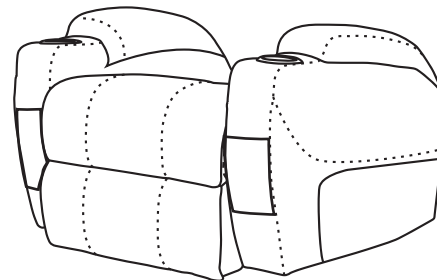

Electric Lift Chair Assembly Instruction

STEP 3

No.1 and No.2 wire connect with the backrest and chair base.
No.3 wire connects with backrest and Motor.
No.4 wire connects with backrest and remote control(E).
No.5 wire connect the backrest and the wire from rightside armrest, which use to charge devices.
No.6 wire connect the backrest and power source (F).

NOTE
1: Two same color wires connect.
2: Plug power cord and power source into outlet, then you can use all function.

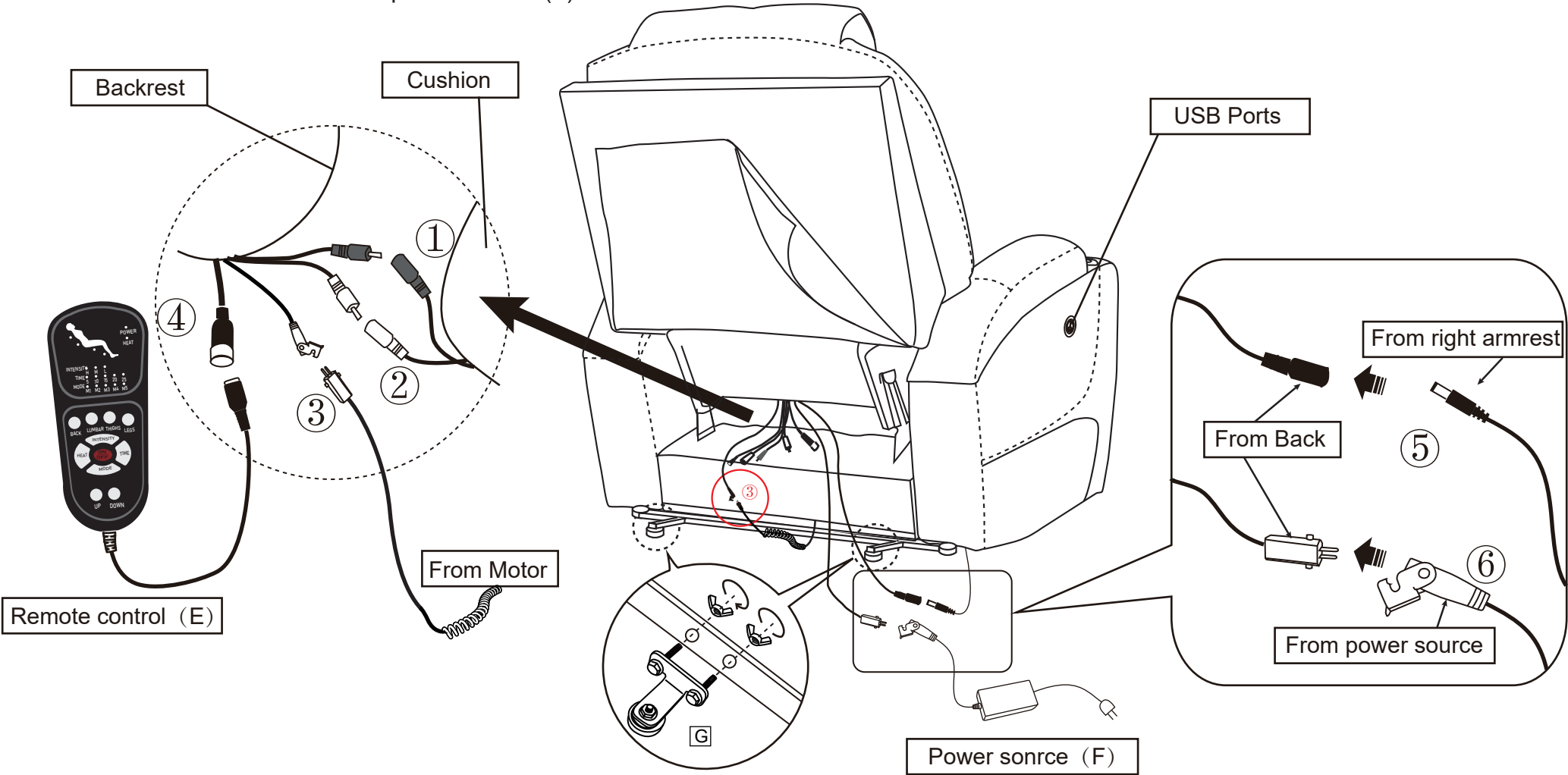

Power Lift Chair Assembly Instruction

How to recline?

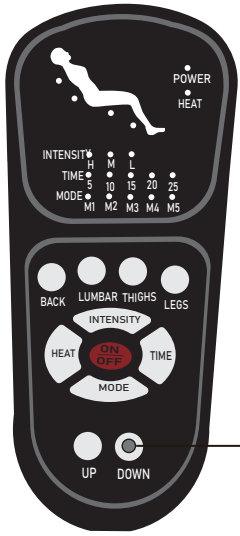

Press

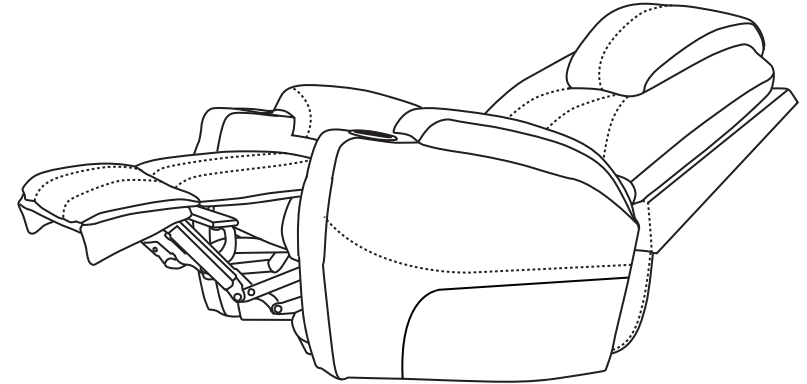
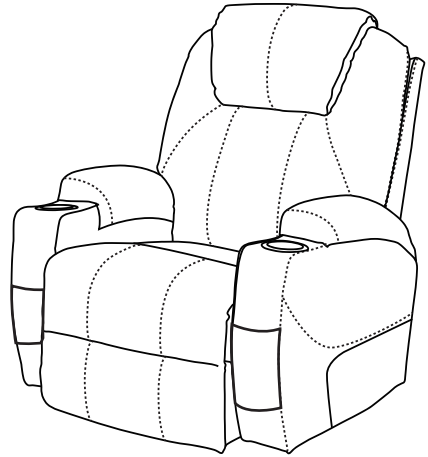

How to get footrest latch down and stand?

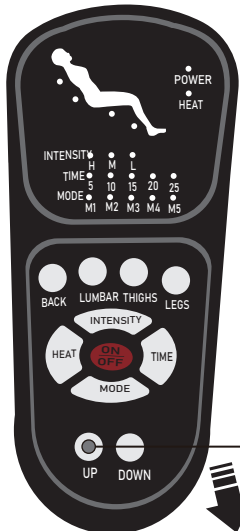

Press

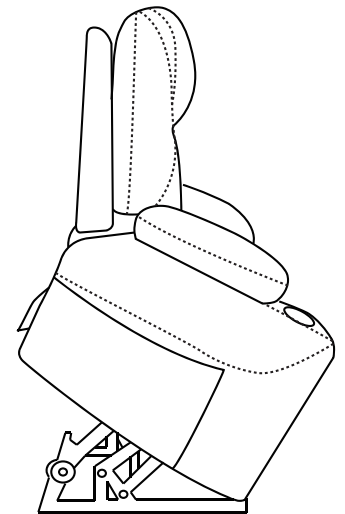
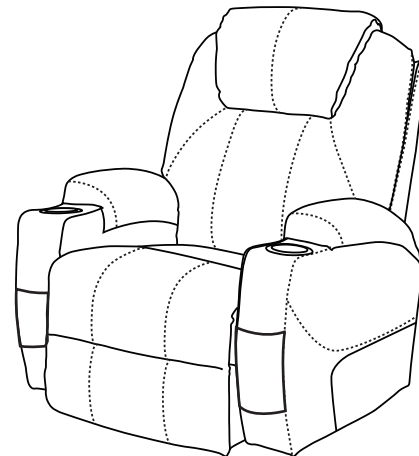
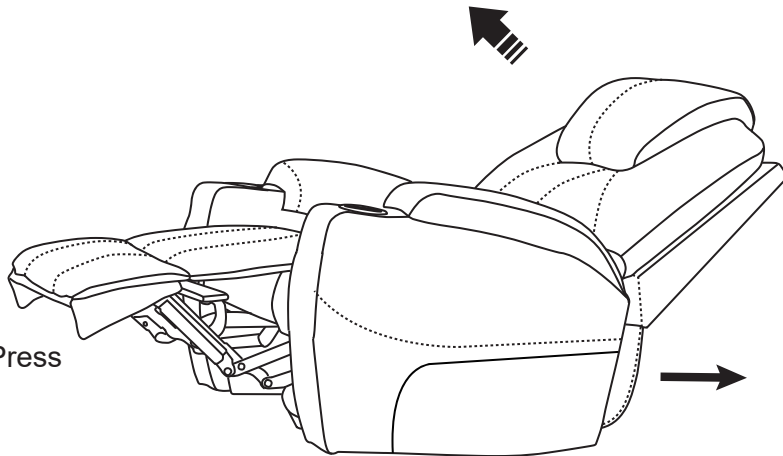

Power Lift Chair Assembly Instruction

How to use remote control?

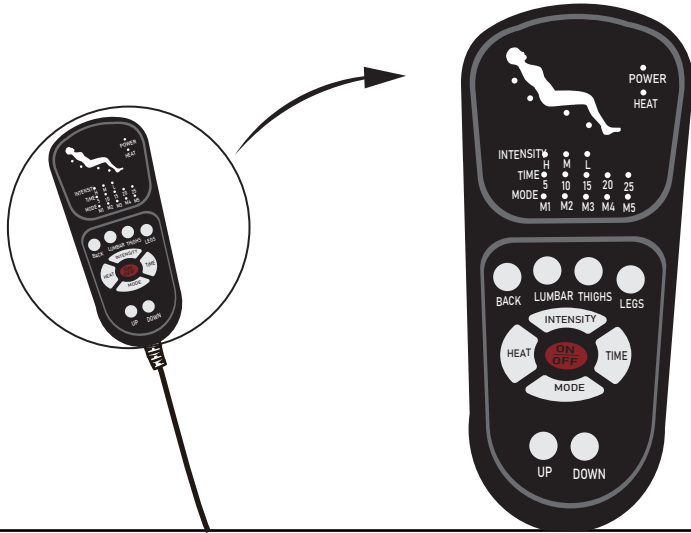

- ① Press UP/DOWN to control the chair up and down.
- ② Press ON/OFF to start massage function.
- ③ Press the HEAT, the heating function will be on.
- ④ Press MODE to select different manual vibration mode(M1-M5)
- ⑤ Press TIME to set up running time from 5 minutes to 25 minutes
- ⑥ Press INTENSITY to adjust the massage intensity(High/Medium/Low)
- ⑦ Press BACK/LUMBAR/THIGHS/LEGS to enjoy.

How to use dual USB Port that outside of right armrest?

The recliner is equipped with specific charger , which it has dual USB outlets (5V 2A) that keep your devices charging, such as nearly all smartphone(like iPhone, Samsung..), ipad, headphones, Kindle...

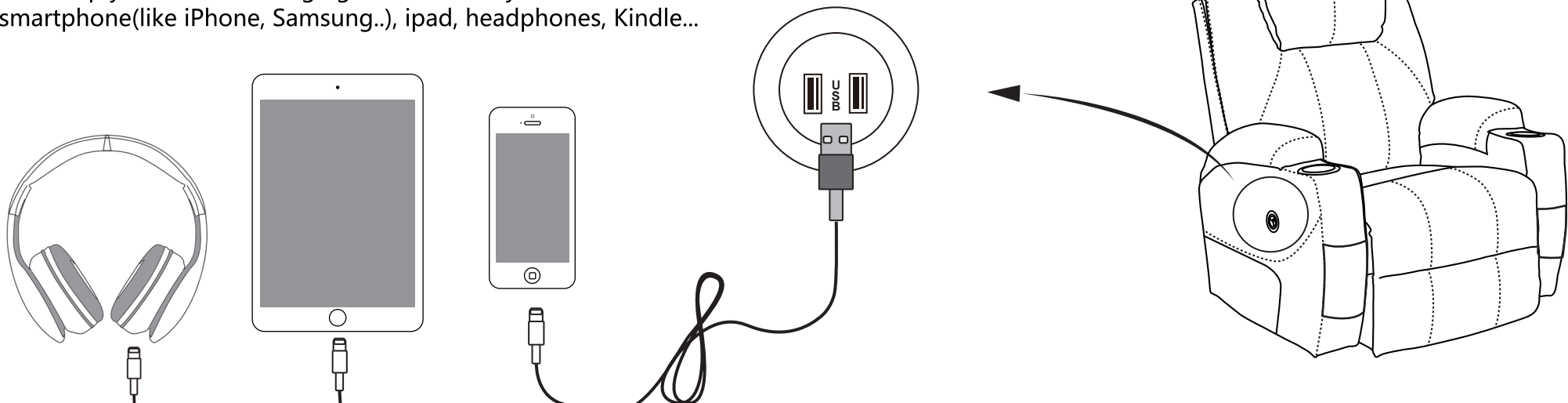

Power Lift Chair Assembly Instruction

FAQ

1.Q: Missing parts when received.

A: Please check if you already received two boxes we shipped to you. Sometimes the two boxes will not arrive in same date, hope you can wait for 2-3 more days or contact us for more help.

If you already have two boxes, please kindly send us messages to let us know the name of missing part regarding to the first page of instructions. We will send replacement to you asap.

2.Q: Some parts damaged when arrived.

A: Please send clear photos about damaged part to us as attachment, we will check and offer you best solution soon.

3.Q: The massage function does not work.

A: Please check if all wires connect correctly, the power source (F) may be defective if indicator does not light on, or if the lights doesn't turn on when you press "ON/OFF" button on the remote, that means the remote is defective.

Please kindly send messages with clear photos to describe the problem, then we will send necessary replacement to you.

4. Q: The chair is stuck on lifting or reclining position, and no response when you press the lifting or reclining button.

A: Please kindly check if the power source (F) and remote(E) are connected well . Sometimes the power source (F) and Remote (E) may fall off from the motor. If they connect well, then check the lift motor if it has some anomaly, like some noise comes out when you press the lift and recline button. If you can make sure the motor is defective, please contact us for replacement.

5. Q: The Heat function does not work or can't feel.

A: Please check all wires connection the same as question 3 first. If the remote also works well, you will need wait for 5-10 mins after you press the "HEAT" button. The heating function only works at lumbar position and the heat temperature isn't very hot.