

Smilecare

Instruction manual

Infrared Forehead Thermometer

Model:UFR106

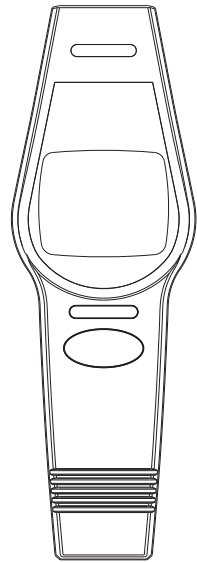

Introduction

▲ Your new Infrared forehead thermometer uses advanced infrared (IR) technology to measure temperature instantly and accurately on the forehead or object.

▲ Easy to use and less measurement time

This thermometer does not need to contact body or object to ensure the safety and hygiene. Its ergonomic design makes this thermometer be simple and very easy to check the temperature. It only takes 1 second to take measurement and reading.

▲ Body and object modes

This thermometer supports to measure temperature of body and object.

Measuring range of object mode is 0.0 to 100.0°C (32.0°F~199.9°F). That means except to take body temperature, it also supports to take the surface temperature of object as below,

Surface temperature of milk in the bottle;

Surface temperature of baby bath;

Environment temperature.

▲ Color visible indication of alarm and alarm sounds

When body temperature is over 37.5°C, color indicator will show red color and an alarm sounds for 10 times.

▲ Memory function

It stores up to 20 sets recent measurement data.

▲ Auto power off

Automatically power off if left idle for Approx 60±20s.

▲ Measurement

Measurement time interval in 1 second and the measurement distance is within 1~3cm.

▲ Intended use :

The Infrared Thermometer is intended for the intermittent measurement and monitoring of human body temperature from forehead or object. The device is indicated for use by people of all ages at homecare and in hospital.

▲ Contraindication(s):None.

▲ The patient is an intended operator.

Object mode is for reference only.

Safety Information

To assure the correct use of the product, basic safety measures should always be followed including the warning and the caution listed in the instruction manual :

Symbol descriptions

The following symbols may appear in this manual, on the label, on the device, or on its accessories. Some of the symbols represent standards and compliances associated with the device and its use.

	WARNING: This alert identifies hazards that may cause serious personal injury or death.
	CAUTION: This alert identifies hazards that may cause minor personal injury, product damage, or property damage.
	Type BF applied part
	Manufacturer
SN	Specifies serial number
	DISPOSAL: Do not dispose this product as unsorted municipal waste. Collection of such waste separately for special treatment is necessary.
	Direct current
	Follow instructions for use
	CAUTION: Consult accompanying documents

▲ This thermometer is not intended to substitute for a consultation with your physician. The forehead scan temperature serves as a reference only. It cannot be a judgment on fever.

▲ Basic safety precautions should always be observed, especially when the thermometer is used on or near children and disabled persons.

▲ Please place the device unreachable by young.

▲ Avoid direct sunlight.

▲ Do not touch the lens.

▲ No modification of this device is allowed.

▲ The swallowing of small parts like packing bag, battery, battery cover and so on may cause the suffocation. .

▲ Please do not use a dilution agent, alcohol or petrol to clean the unit. Please treat it gently and prevent the falling from a high place.

▲ Please do not immerse it in liquid.

Never leave battery in the battery compartment for a long time without use, as they may leak and cause damage to the unit.

▲ Please take off the battery if you do not intend to use within 3 months. Replace with new batteries if the unit displays a low battery symbol.

▲ Do not mix the old and new batteries together.

▲ Do not use during the transportation.

▲ WARNING:

Do not dispose of electrical appliances as unsorted municipal waste, use separate collection facilities. Contact your local government for information regarding the collection systems available. If electrical appliances are disposed of in landfills or dumps, hazardous substances can leak into the groundwater and get into the food chain, damaging your health and well-being.

Classification

- Internally powered equipment;
- Type BF applied part; .
- Protection against ingress of water or Particulate matter: IP21;
- Not category AP/APG equipment;
- Mode of operation: Continuous operation.

▲ The user must check that the equipment functions safely and see that it is in proper working condition before being used.

Product Structure

-Display

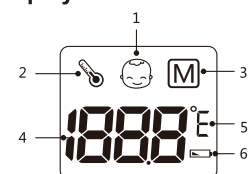

- Body temperature indicator
- Object temperature indicator
- Memory mode
- Temperature reading
- Temperature unit
- Low battery indicator

-Body

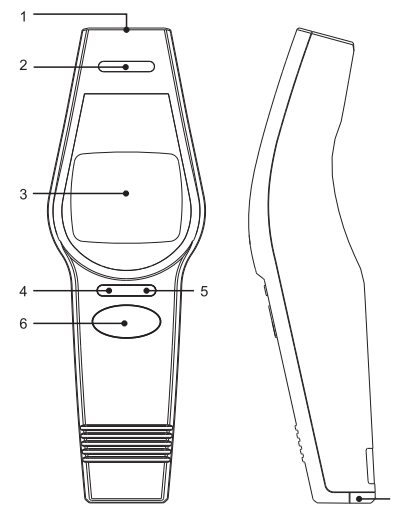

- Auto-sense Probe
- 2-Color LED
- Display Screen
- SET Button
- MEM Button
- START/STOP Button
- Battery Cover

Battery Installation

Remove the battery cover from the battery compartment, insert the battery.

1. Remove the battery cover from the battery compartment as the arrow direction accordingly.

2. Insert 2 AAA powerful batteries into the compartment and ensure each battery is in the proper direction, Positive (+) and Negative (-) are displayed on the back of battery cover.

3. Close the battery cover.

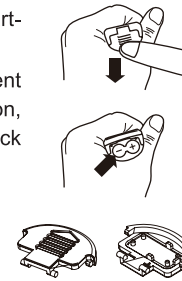

Low battery and replacement

When power on, the low battery symbol will display once the unit starts to work, and you must replace with new batteries, otherwise the unit can't work.

Battery type and replacement

Please use 2pcs AAA identical 1.5V alkaline batteries.

Do not use the batteries beyond their expiry date.

Please remove the batteries if you do not need to use for long time.

WARNING

Dispose of the battery in accordance with all federal, state and local laws. To avoid fire and explosion hazard, do not burn or incinerate the battery.

Setting Mode

How To Set

1. Mode setting:

Press SET Button when power on after you hear 1 beep, the screen will display or , Mode will change between and . When the SET Button is pressed. It will confirm the Body Mode automatically when you switch to , and confirm the Object Mode automatically when you switch to . Then Mode setting is finished.

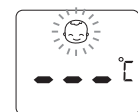

Body mode

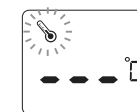

Object mode

Note: The Body Mode is used to measure the forehead temperature, then the Object Mode is used to measure the object temperature.

2. Unit setting:

Long press SET Button when power on after you hear 1 beep, the screen will display or , Mode will change between and . When the SET Button is pressed. It will confirm the Celsius Unit automatically when you switch to , and confirm the Fahrenheit Unit automatically when you switch to . Then press START/STOP Button make the confirmation selection, and after the selection is completed, it will automatically enter the sound switch setting mode.

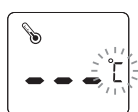

Celsius/°C

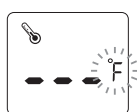

Fahrenheit/°F

3. Sound switch setting:

Enter the sound switch setting mode, or is displayed on the screen and flashes, press SET Button to select and press START/STOP Button to confirm selection.



Proper Use Of The Unit

Pre-measurement

About Normal Body Temperature & Fever

The temperature in the forehead and temple area differs from the internal temperature, which is taken orally or rectally. Vasoconstriction, an effect which constricts the blood vessels and cools the skin, can occur during the early stages of a fever. In this case, the temperature measured by the Infrared thermometer may be unusually low. If the measurement therefore does not match the patient's own perception or is unusually low, repeat the measurement every 15 minutes. As a reference, you can also measure the internal body temperature using a conventional oral or rectal thermometer.

Body temperature can vary from one individual/person to next.

It also varies by location on the body and time of day. Below shows the statistical normal ranges from different sites.

Please keep in mind that temperatures measured from different sites, even at the same time, should not be directly compared. Fever indicates that the body temperature is higher than normal. This symptom may be caused by infection, overdressing or immunization. Some people may not experience fever even when they are ill.

These include, but are not limited to, infants younger than 3 months old, persons with compromised immune systems, persons taking antibiotics, steroids or antipyretics (aspirin, ibuprofen, acetaminophen), or persons with certain chronic illnesses. Please consult your physician when you feel ill even if you do not have fever.

Table*1 Body Site Normal Temperature Range

Body Site	Normal Temperature Range
Oral	0.6°C (1°F) or more above or below 37°C (98.6°F)
Rectal/ear	0.3°C to 0.6°C (0.5°F to 1°F) higher than oral temperature
Axillary (armpit)	0.3°C to 0.6°C (0.5°F to 1°F) lower than oral temperature

Note: Body Temperature at WebMD;

website: <http://firstaid.webmd.com/body-temperature>; retrieved at 2010 Jan 7.

As a Body Thermometer

1). Press the START/STOP Button, all symbols appear on the display, you can hear 1 short beep, then unit °C/°F on the display start to flash.

2). Press the SET Button to select Body Mode, the temperature unit flashes.

3). Move the probe close to the forehead, make sure the probe is flat and take measurement with a distance between 1~3cm. Press the START/STOP Button, the meter will take measurement.

4). The measurement will be finished in 1 second, when it has been completed you can hear 1 short beep, in the meantime, the reading will appear on the display with green LED blinks.

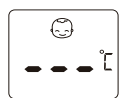

Note:

● If the reading is < 37.5°C (99.5°F), the display will show together with green LED and 1 short beep.

● If the reading is ≥ 37.5°C (99.5°F) and < 43°C (109.4°F), the display will show together with red LED and 10 short beeps.

● Only after the unit °C/°F start to flash again, it can continue to take measurement.

● As the forehead measurement temperature is likely to be affected by sweat, oil and the surroundings, the reading shall be taken as a reference only.

● If the probe is placed at an angle close to the forehead measurement, the reading will be affected by surrounding temperature.

● Babies' skin reacts very quickly in the ambient temperature. Therefore, do not take their temperature with the non-contact thermometer during/after breastfeeding, because the skin temperature may be lower than the internal body temperature.

As a Object Thermometer

1). Press the START/STOP Button, all symbols appear on the display, you can hear 1 short beep, then unit °C/°F on the display start to flash.

2). Press the SET Button to select Object Mode, the temperature unit flashes.

3). Move the probe close to the object, make sure the probe is flat and take measurement with a distance between 1~3cm. Press the START/STOP Button, The meter will take measurement.

4). The measurement will be finished in 1 second, when it has been completed, you can hear 1 short beep, in the meantime, the reading will appears on the display with green LED blinks.

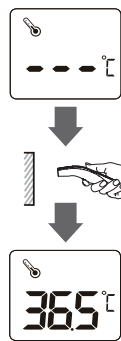

Note:

●As the object scan temperature is likely to be affected by the surroundings, the reading shall be taken as a reference only.

●If the probe is placed at an angle close the object scan, the reading will be affected by surrounding temperature.

Memory-recall of measurements

This Non-contact forehead thermometer automatically stores 20 sets measurements value, the oldest record will be replaced by the latest measurement value when more than 20 sets.

Read memory record

Press the MEM Button to enter the memory mode when power off. Each time you press the MEM Button, a number (from 1 to 20) will be displayed along with the symbol , 1 second later, the measurement will be shown, as well as subsequent measurements can be display one after the other by pressing the MEM Button each time.

Note:

The reading number "1" is the latest measurement, "20" is the oldest measurement. When the oldest measurement is read, pressing the MEM Button again will read the reading "1" again.

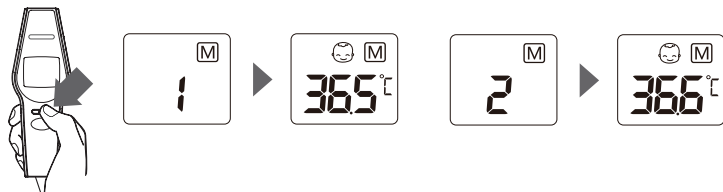



Memory-clear Of Measurements

If you are sure that you want to remove all stored memories permanently, Long press the MEM Button for 10 seconds until CLR appears when power off, CLR will flashes for 5 times to clear all the memories along with 5 short beeps.

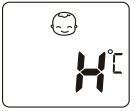
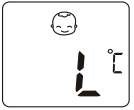
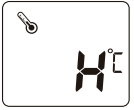
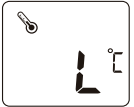

Exceptional Situation

Symbol	Correction
	In Body Mode, Measured temperature is above Measuring range of 43°C/109.4°F, it is shown on the LCD with red LED.
	In Body Mode, Measured temperature is below the Measuring range of 32°C/89.6°F, it is shown on the LCD with red LED
	In Object Mode, Measured temperature is above Measuring range 100.0°C/199.9°F or environmental temperature is above system Operating range 40°C/104.0°F, it is shown on the LCD with red LED.
	In Object Mode, Measured temperature is below Measuring range 0.0°C/32.0°F, or environmental temperature is be low system operating range 5°C/41.0°F, it is shown on the LCD with red LED.

	Low battery, replace all the worn batteries with new ones.
	Thermometer system fails or affected by electric magnetic field

⚠ Please contact the distributor if you can not solve the problem, do not disassemble the unit by yourself!

Care And Maintenance





Care for the main unit

●Keep the unit in the storage case when not in use.

●Clean the unit with a soft dry cloth. Do not use any abrasive or volatile cleaners.

●Never immerse the unit or any of its' component in water.

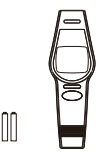
Maintenance

Do not clean the unit with naphtha, thinner or gasoline etc.	Store the unit in a clean and dry location. not subject the unit to extreme hot or cold temperature, humidity and direct sunlight.
	
Remove the batteries if the unit will not be used in 3 months or longer.	Do not use the unit under the influence of electromagnetic interference (nearby cellphones, microwave etc.)
	

Note: We will not be responsible for any quality problem if you do not care and maintain the product as instructed.

Specification

Description	Non-contact Infrared Forehead Thermometer		
Display	LCD digital display		
Measuring localization	Forehead and object surface		
Measurement range	Body mode:32.0°C~43.0°C(89.6°F~109.4°F); Object mode:0.0°C~100.0°C(32.0°F~199.9°F);		
Temperature unit	°C/°F		
Display resolution	0.1°C/0.1°F		
Accuracy	±0.2°C/±0.4°F (within 36.0°C~39.0°C/96.8°F~102.2°F)		
Memory function	20 sets memory of measurement values		
Beep alarm	1 short beep when power on and start measurement; 1 long beep when measurement reading is below 37.5°C/99.5°F; 10 short beeps when measurement reading is greater than or equal to 37.5°C/99.5°F; 3 short beeps when system fails		
LED color indicator	Green: Temperature<37.5°C/99.5°F; Red: Temperature≥37.5°C/99.5°F		
Power source	2pcs AAA alkaline battery (not included)		
Automatic power-off	In 60±20s	Manual shutdown	In 8s
Main unit weight	Approx.75g (battery is not included)		
Main unit size	L151mm*W53mm*H41mm		
Battery life	Could be used for 300 times for normal condition		
Accessoy	Instruction manual		
Operating environment	Body mode: 10.0°C~40.0°C(50.0°F~104.0°F); Object mode: 5.0°C~40.0°C(41.0°F~104.0°F); Atmospheric pressure range: 70kPa~106kPa; Relative humidity range: ≤85%RH		
Storage environment	Temperature:-20.0°C~50.0°C(-4.0°F~+122.0°F) Humidity: 15%~95%RH Atmospheric pressure range: 70kPa~106kPa avoid crash, sun burn or rain during transportation		
Expected service life	Five years		
Software Ver	UFR1.0		

Clinical Measurement Accuracy And Safety Verification:

The product has passed clinical trials. The measured results of the infrared forehead thermometer was compared with the measured results of mercury thermometers, the deviation average $\Delta t_0 = 0.011^\circ\text{C}$ not exceeding 0.3°C ; the clinical repeatability of the infrared forehead thermometer $\hat{S}R = 0.100^\circ\text{C}$, not exceeding 0.3°C . The measured results up to the laboratory standard and the clinical standard. Therefore, the deviation average and the clinical repeatability of the infrared forehead thermometer are complied with the regulatory requirement ISO 80601-2-56. The conclusions are drawn from the clinical trials, the accuracy and safety are complied with the regulatory requirement.

Warranty Information

▲The unit is guaranteed to be free of defects in workmanship and materials under normal use for a period of 1 Year from the date of purchase.

▲For repair under this warranty. Our authorized service agent must be advised of the fault within the period of the warranty. This warranty only covers parts and labor service under normal operations. Any defect resulting

from natural causes, eg. flood, hurricane etc, is not covered in this guarantee. This guarantee also does not cover damage incurred by use of the unit not in accordance with the instructions, accidental damage, or being tampered or serviced by unauthorized service agents.

▲The following will be excluded from this warranty-if the thermometer has been misused, abused, or neglect in following the manual's instructions on purpose and unauthorized repair or modifications.

▲The device requires no calibration.

▲The device is not repairable and contains no user serviceable parts.

EMC

IEC 60601-1-2: 2014 ME EQUIPMENT and ME SYSTEMS identification, marking and documents for Class B product

Instructions for use

The ME EQUIPMENT or ME SYSTEM is suitable for home healthcare environments and so on.

The ME EQUIPMENT or ME SYSTEM is suitable for home healthcare environments and so on.

Warning: Don't near active HF surgical equipment and the RF shielded room of an ME system for magnetic resonance imaging, where the intensity of EM disturbances is high.

Warning: Use of this equipment adjacent to or stacked with other equipment should be avoided because it could result in improper operation. If such use is necessary, this equipment and the other equipment should be observed to verify that they are operating normally.

Warning: Use of accessories, transducers and cables other than those specified or provided by the manufacturer of this equipment could result in increased electromagnetic emissions or decreased electromagnetic immunity of this equipment and result in improper operation."

Warning: Portable RF communications equipment (including peripherals such as antenna cables and external antennas) should be used no closer than 30 cm (12 inches) to any part of the infrared thermometer, including cables specified by the manufacturer. Otherwise, degradation of the performance of this equipment could result.

If any of a list of all cables and maximum lengths of cables (if applicable), transducers and other ACCESSORIES that are replaceable by the RESPONSIBLE ORGANIZATION and that are likely to affect compliance of the ME EQUIPMENT or ME SYSTEM with the requirements of Clause 7 (EMIS-SIONS) and Clause 8 (IMMUNITY). ACCESSORIES may be specified either generically (e.g. shielded cable, load impedance) or specifically (e.g. by MANUFACTURER and EQUIPMENT OR TYPE REFERENCE).

If any of the performance of the ME EQUIPMENT or ME SYSTEM that was determined to be ESSENTIAL PERFORMANCE and a description of what the OPERATOR can expect if the ESSENTIAL PERFORMANCE is lost or degraded due to EM DISTURBANCES (the defined term "ESSENTIAL PERFORMANCE" need not be used).

Technical description

1.All necessary instructions for maintaining BASIC SAFETY and ESSENTIAL PERFORMANCE with regard to electromagnetic disturbances for the excepted service life.

2.Guidance and manufacturer's declaration -electromagnetic emissions and Immunity

Table 1

Guidance and manufacturer's declaration - electromagnetic emissions	
Emissions test	Compliance
RF emissions CISPR 11	Group 1
RF emissions CISPR 11	Class B
Harmonic emissions IEC 61000-3-2	N/A
Voltage fluctuations/ flicker emissions IEC 61000-3-3	N/A

Table 2

Guidance and manufacturer's declaration - electromagnetic Immunity		
Immunity Test	IEC 60601-1-2 Test level	Compliance level
Electrostatic discharge (ESD) IEC 61000-4-2	±8 kV contact ±2 kV, ±4 kV, ±8 kV, ±15 kV air	±8 kV contact ±2 kV, ±4 kV, ±8 kV, ±15 kV air
Electrical fast transient/burst IEC 61000-4-4	Power supply lines: ±2 kV input/output lines: ±1 kV	N/A
Surge IEC 61000-4-5	line(s) to line(s): ±1 kV. line(s) to earth: ±2 kV. 100 kHz repetition frequency	N/A
Voltage dips, short interruptions and voltage variations on power supply input lines IEC 61000-4-11	0% 0.5 cycle At 0°, 45°, 90°, 135°, 180°, 225°, 270° and 315° 0% 1 cycle And 70% 25/30 cycles Single phase: at 0 0% 300 cycle	N/A
Power frequency magnetic field IEC 61000-4-8	30 A/m 50Hz/60Hz	30 A/m 50Hz/60Hz
Conducted RF IEC61000-4-6	150KHz to 80MHz: 3Vrms 6Vrms (in ISM and amateur radio bands)80% Am at 1kHz	N/A
Radiated RF IEC61000-4-3	10 V/m 80 MHz – 2,7 GHz 80 % AM at 1 kHz	10 V/m 80 MHz – 2,7 GHz 80 % AM at 1 kHz
NOTE UT is the a.c. mains voltage prior to application of the test level.		

Table 3

Guidance and manufacturer's declaration - electromagnetic Immunity							
	Test Frequency (MHz)	Band (MHz)	Service	Modulation	Modulation (W)	Distance (m)	IMMUNITY TEST LEVEL(V/m)
	385	380 – 390	TETRA 400	Pulse modulation 18 Hz	1,8	0.3	27
	450	380 – 390	GMRS 460, FRS 460	FM ± 5 kHz deviation 1 kHz sine	2	0.3	28
	710	704 – 787	LTE Band 13, 17	Pulse modulation 217 Hz	2	0.3	9
	810	800 – 960	GSM 800/900, TETRA 800, iDEN 820, CDMA 850, LTE Band 5	Pulse modulation 18 Hz	2	0.3	28
	1720	1 700 – 1 990	GSM 1800; CDMA 1900; GSM 1900; DECT; LTE Band 1, 3, 4, 25; UMTS	Pulse modulation 217 Hz	2	0.3	28
	1845	2 400 – 2 570	Bluetooth,WLAN, 802.11 b/g/n,RFID 2450, LTE Band 7	Pulse modulation 217 Hz	2	0.3	28
	5240	5 100 – 5 800	WLAN 802.11 a/n	Pulse modulation 217 Hz	0.2	0.3	9
	5500						
	5785						

Jiangsu Konsung Bio-Medical Science And Technology Co.,Ltd
No. 8, Shengchang West Rd, Danyang Development Zone,
Jiangsu Province, China
Tel:86-511-86375988
WhatsApp: 0086-18952012596
E-mail: info@konsung.com
Website: www.konsungmedical.com

Manufacturer
Shenzhen Union Technology Co.,Ltd.
Floor 4-6th of Building D,Jiale Science&Technology Industrial Zone,No.3,ChuangWei Road,Heshuikou Community,MaTian Street, GuangMing New District,518106 ShenZhen,PEOPLE'S REPUBLIC OF CHINA
Tel: (86) -755-29231308
MADE IN CHINA

Shanghai International Holding Corp. GmbH (Europe)
Eiffestrasse 80, 20537 Hamburg,Germany
Tel:+49-40-251317 E-mail:shholding@hotmail.com

