

## S700 Bike Computer User Manual

This bike computer user manual is only for Black Leopard, Green Leopard and White Leopard operations setting reference.  
If you are using other Haoqi Ebikes models, please contact Haoqi Support Team for help.



Manual

LCD-S700 Ebike Intelligent Display

## 1. Material&Dimension

### 1) Material

Caser and Cover and Press button: ABS,

LCD window: PMMA

### 2) Outside and mounting dimensions(mm)

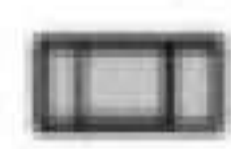
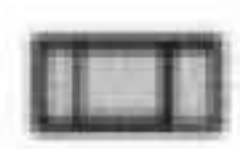
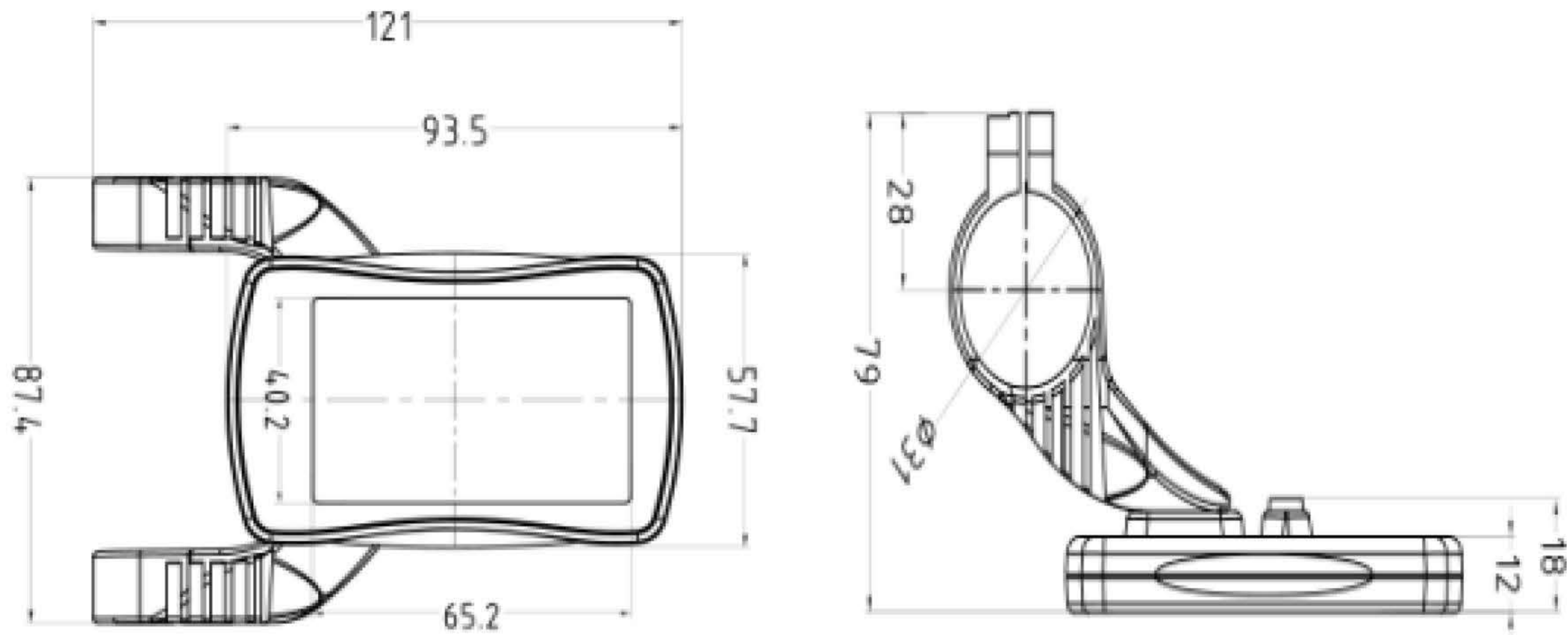

Scew 2.6\*8

Scew 4\*16



### 3) Press button outside and mounting dimensions(mm)



Scew 2\*8

Scew 4\*16



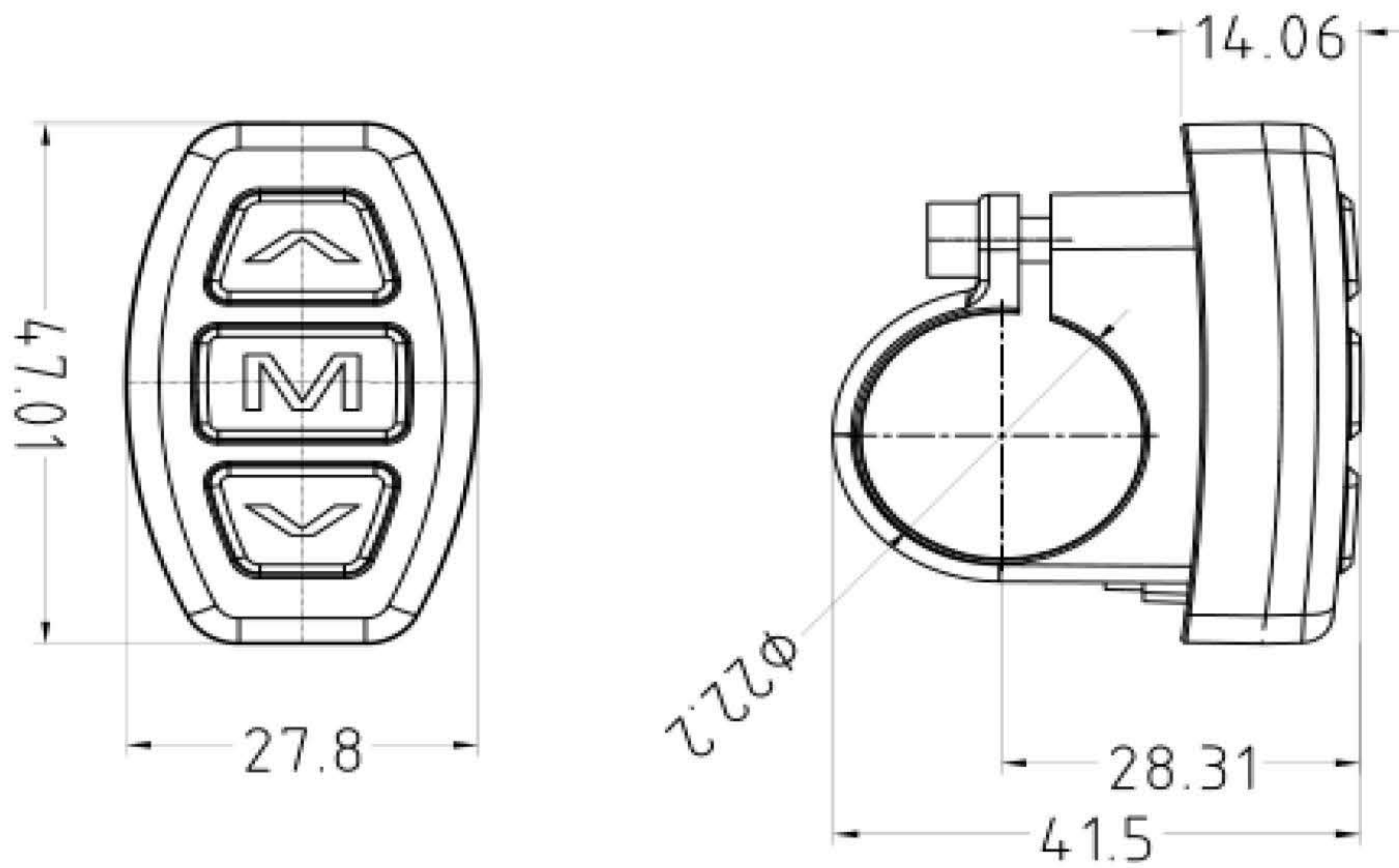

#### 4) Connection diagram:

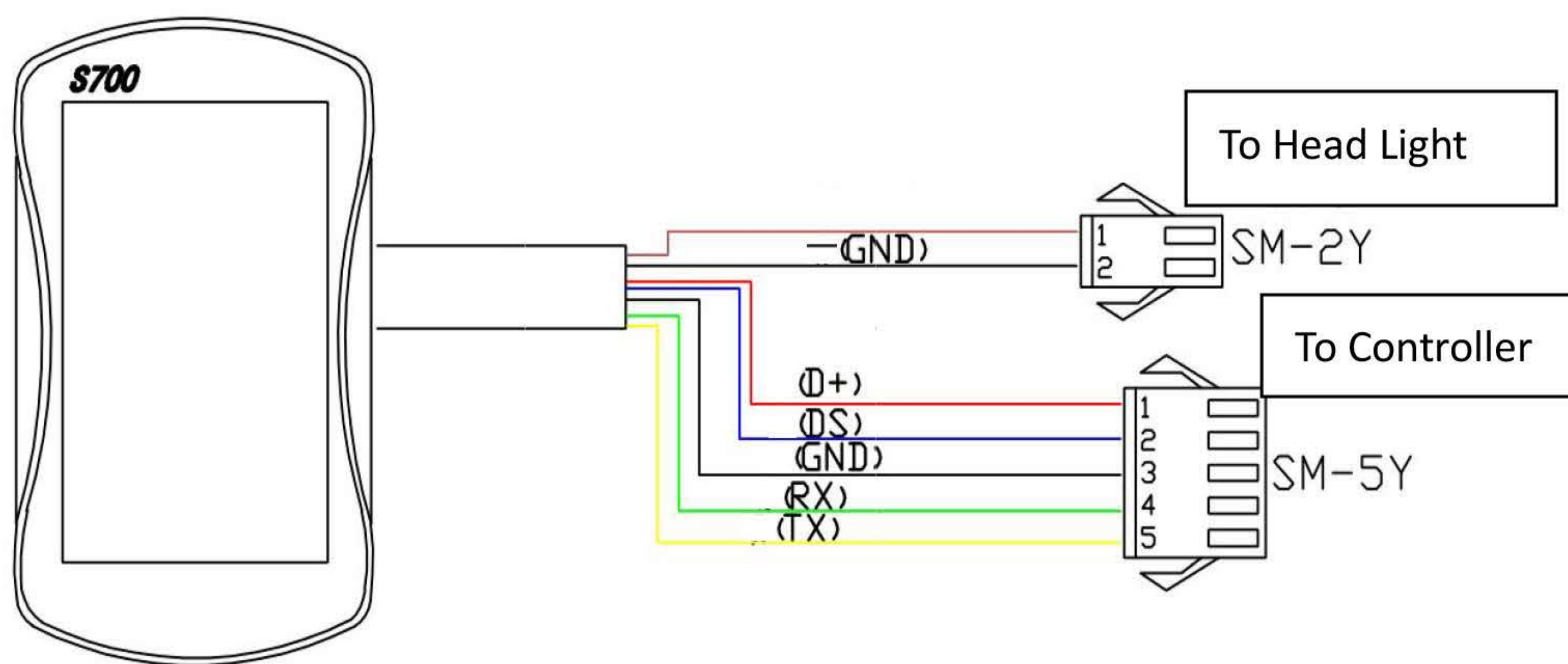

#### Wire definition:

Red: Power supply-VCC

Blue: Electronic lock-DS

Black: GND

Green: Data RXD

Yellow: Data TXD

BROWN: Head light(+)-DD

White: Head light(-)-GND

Remark: Connectors and Wire colors could be customized

## 5) Installation

- Install the display in the middle of handlebar, then adjust to suitable angle, install the press button to left side of handlebar.
- Power off the device, connect the device to controller.
- Power on



## 2. Overview of S700

### 1) UART protocol:

Equipped with independent press buttons

### 2) Speed:

Real-time SPEED, MAX SPEED, Average SPEED

### 3) kmh/mile:

Kmh/MPH according to habit

4) Battery level:

Indicates the battery level in real time

5) Head light control:

Press button to power on/off

6) Back light adjustment:

3-level adjustment

7) Assist level:

From 0 to 5, press button to change assist level, 0-no assist,

5-default value

8) Distance:

ODO/Trip/Driving duration

9) Error code:

Please refer to appendix table 1 for definition

10) 6km mode:

In this mode, it will display “WALK” on the screen

11)Parameter setting:

Set parameters, such as: wheel size, speed limit etc

### 3. Presentation of screen

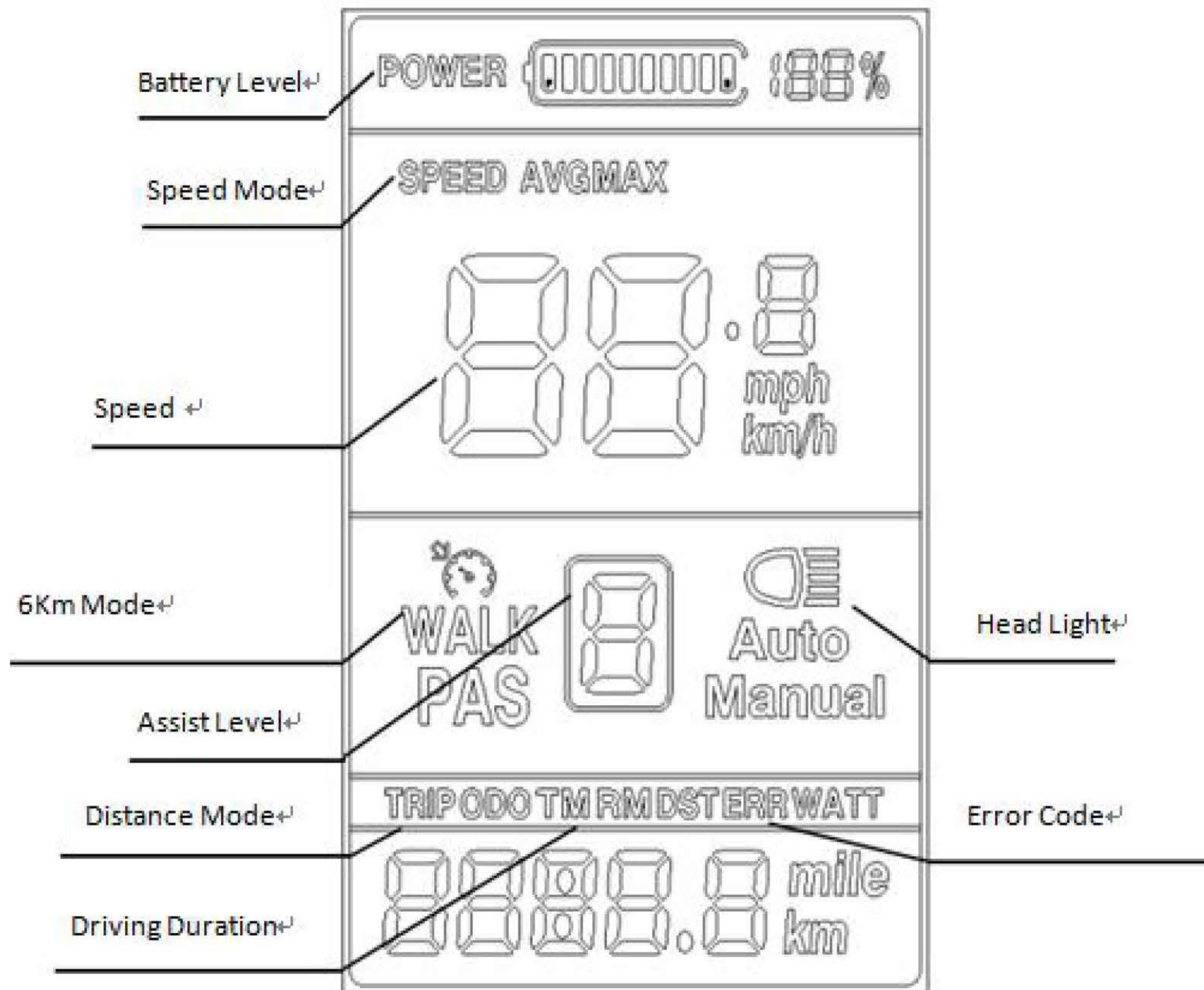

- 1) Battery level: 5 levels, voltage interval could be customized
- 2) Speed: Average SPEED/MAX SPEED/Real-time SPEED
- 3) Speed unit: Kmh/MPH
- 4) 6km mode
- 5) Assist level: actual assist level 0~5.
- 6) Head light icon: indicates when head light and back light are on
- 7) Distance: Trip/ODO
- 8) Driving Duration
- 9) Error code: "ERROR" and code when there is error



## 4. Press button definition

LCD-S700 uses independent press button, in total three buttons:





## 5. Operation instructions

### 1) Power ON/OFF

When the power is off, Long press  ( MODE ) during 3 seconds , screen will display all contents and start to normal working mode, and controller will be turned on When the power is on, Long press  ( MODE ) during 3 seconds, screen will be powered off, and controller will be turned off 。 If no any operation both on bike and display during 10minutes(time could be set), the display will turn off automatically, in this case, no power consumption for both display and controller.



## 2) ODO/TRIP

Long press  and  to switch different speed information, Real time speed( SPEED)→ Max speed( MAX SPEED)  
→Average speed ( AVGSPEED)





### 3) ODO/TRIP/ Driving Time/Error Code

Short press  to switch ODO/TRIP/ Driving Time/Error Code

Trip(Single trip distance) → ODO(Accumulated distance) →  
TM (Driving Time) → REE (Error Code)。

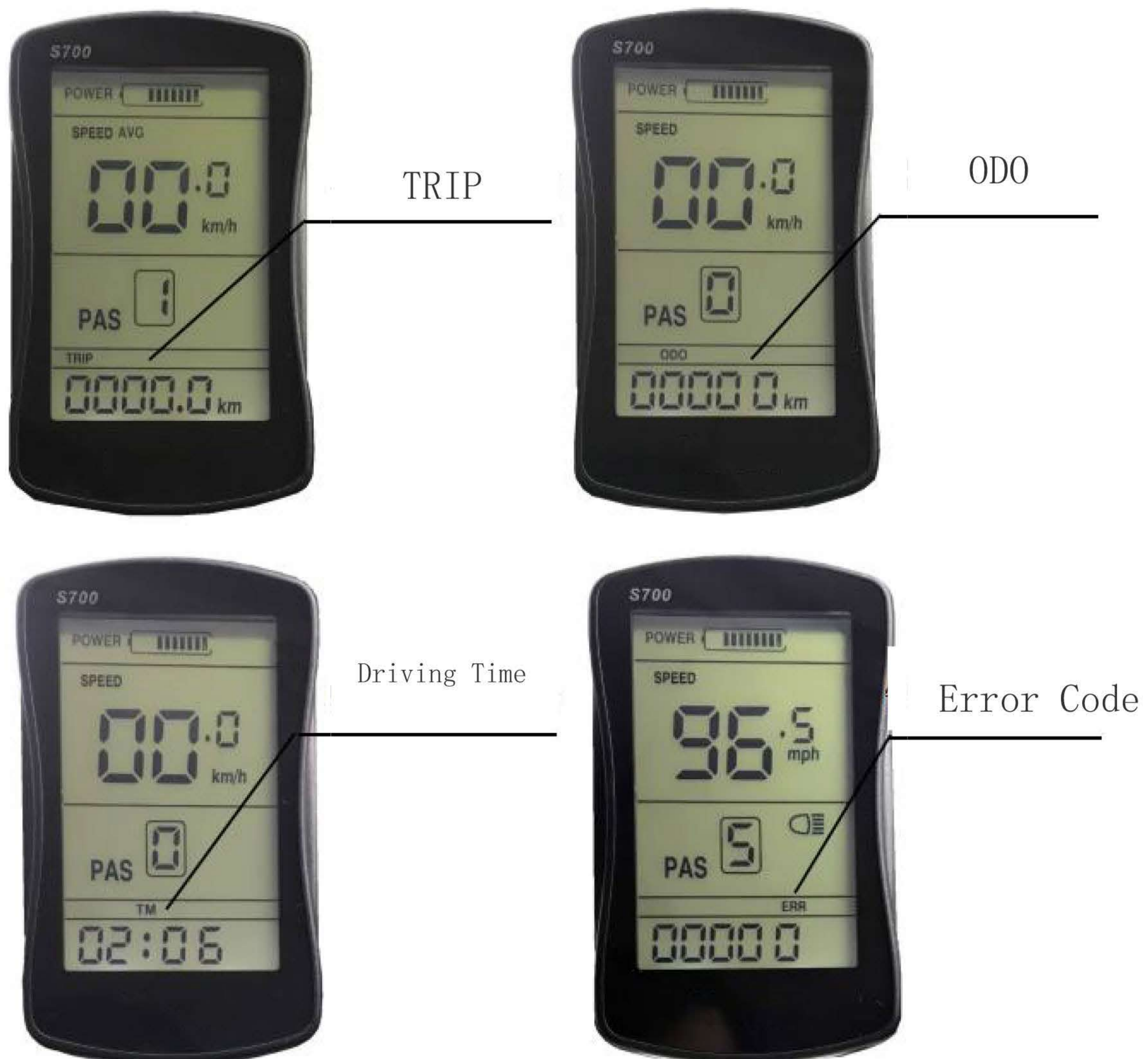

### 4) Assist level

Short press  or  to change assist level, default value is level 1



## 5) Head light control

Long press  for 3 seconds turn on/off the head light.



## 6) 6km mode





When the bike is stopped, long press , will enter 6km/h mode, the speed will be 4.5~7.5km/h according to different road



conditions, "WALK" will show up on screen, long press  again

or short press , will quit 6km/h mode. Long press or short press could be customized by clients.





## 6. Parameter setting

When the display is powered on, long press  and , will enter parameter setting mode, in this mode, can change parameter values, long press again  and  will quit parameter setting mode or no operation during 10s will also quit this mode.

In parameter setting mode, short press  /  will change parameter value, short press  will save current value and switch to next parameter.

## 1) P01-back light lightness:

short press  /  will switch from 1 to 3, Level 3 is lightest. Level 2 is default value.



Level 2 – default value

## 2) P02-kmh/MPH:

Short press  /  to Switch kmh/MPH.



Km by default





mph

### 3) P03-Working voltage:

short press  /  to switch 24V,36V,48V, Default value is 36V.



### 4) P04-Auto shutdown time:

short press  /  to switch from 0 to 60, it is the time(in minutes) to shut down the screen automatically if no operation 0 means never shut down, Default value is 10 minutes



## 5) P05-Number of Assist levels:

Short press  /  to change level 0->1->2.

0: 3 assist levels    1: 5 assist levels    2: 9 assist levels



## 6) P06-Wheel size selection:

short press  /  to switch wheel size, in inch,  
step: 0.1 inch





## 7) P07-Number of magnets for speed sensor:

short press  /  to switch from 1 to 100.



100 magnet for Speed sensor

## 8) P08-speed limit:

short press  /  to set the speed limit from 0 to 100Km/h, 100 means no limit.



Speed limit 100Km/h

9) P11-assist sensitivity setting:

short press  /  to switch from 1 to 24.



10) P12-assist starting power setting:

short press  /  to switch from 0 to 5.





## 11) P13-Assist magnetic disc types

short press  /  to switch from 5->8->12,  
different numbers of magnets.



12 magnets in the disc

## 12) P14-Current limit for the controller:

short press  /  to switch from 1 to 20A



MAX current in controller  
Is limited to 13A

### 13) P15-low voltage protection for controller

long press  during 5 seconds



Controller is protected under 29V

### 14) P16-Reset ODO distance:

long press  during 5 seconds



Cleared to 0



ODO is 0

15) P18-Reset all parameters:

long press 5 seconds, when it displays "SSSS", all parameters reset to default values(except for the ODO distance)



Ssss means reset to default value

## 7. Specifications

- 1) Power supply: 24V,36V,48V
- 2) Rated current: 10mA
- 3) Max current: 30mA
- 4) Leakage current after power off: <1uA
- 5) Current supply to controller:50mA
- 6) Working Temperature: -18~65°C
- 7) Storage temperature: -30~80°C

## 8. Error code definition

When an error appears, S700 will notice users by different codes, please refer to table 1 for different codes:

Code (Decimal)	Signification	
0	Normal	
6	Low Battery level	
7	Motor error	
8	Throttle error	
9	Controller error	
10	UART receive error	
11	UART receive error	

Table 1

## 9. Notices

Power on and power off must keep an interval of at least 3 seconds,

please don't press "" button frequently when it is powered off.

When the temperature is under  $-10^{\circ}\text{C}$ , the screen will be a little darker than normal, when the temperature increases, the screen can go back to normal

## 10. FAQ

1) Q: Why I can not power off?

A: Please check connection between display and controller.

2) Q: What can I do if an error code displays?

A: Find a nearest shop to get repair

## 11. Warranty

1 year of warranty for quality issue except frame is broken.

## 12. Version

This is a universal manual for S700. It could be customized by each client. Please confirm all details before purchasing.