



# 3D PRINTING USER MANUAL

FOR MINGDA MAGICIAN X2 3D PRINTER

# Mingda Magician X2: Official instructions

Version 2.0 - Sept. 6th, 2023

The latest version of the Magician X2 handbook can always be found at

<https://3dmingdaofficial.com/pages/magician-firmware-driver-and-video>

## Quick Guide to the First Print

1. Read the Safety Instructions carefully.
2. Place the printer on a flat and stable surface.
3. Download the latest firmware from our website and install it.
4. Calibrate the printer with auto-leveling.
5. Insert the SD card that came with your printer and print your first object.

## How to contact Mingda technical support:

First, check the last sections of this manual that deal with common problems. Then send an email to [support@3dmingda.com](mailto:support@3dmingda.com) and/or use our chat at [3dmingdaofficial.com](https://3dmingdaofficial.com). Try to describe your problem as accurately as possible - ideally include pictures or videos.

# Table Of Contents

<b>1. Introduction</b>	09
<b>2. Unpacking and Package Contents</b>	09
2.1. How to Move the Printer	09
2.2. Contents of the Package and Accessories	10
<b>3. Magician X2 Overview and Glossary</b>	11
3.1. Product Display	11
3.2. Connecting and Disconnecting the Power Cable	12
<b>4. Your First Print</b>	12
4.1. Machine Operation	13
4.2. Print Sheets	22
4.3. Inserting (Loading) filament	23
4.4. Unloading (Removing) Filament	24
4.5. Starting the First Print	25
4.6. Removing a Printed Object from the Print Sheet	26
4.7. First Print Troubleshooting	26
4.7.1. First layer peeling off from the bed	26
4.7.2. Nozzle moves too high/low, or extrudes plastic outside the print area	27
4.7.3. The nozzle does not start extruding, even after multiple attempts	28
4.7.4. After a few hours of printing, the nozzle stops extruding filament	28
4.8. Updating the Firmware	29
4.9. Sample Models	30
<b>5. Printing Your Own Models</b>	31

<b>6. Obtaining Printable Models</b>	32
6.1. Create Your Own Model	33
6.2. What is a G-code File?	33
6.3. Mingda Cura slicer Interface Explained	34
6.3.1. Initial Setup and General Workflow	34
6.3.2. Using Supports	35
6.3.3. Speed vs Print Quality	36
6.3.4. Infill	37
6.3.5. Brim	37
6.3.6. Printing Objects Larger than the Print Volume	38
6.3.7. Slicing and Exporting	38
<b>7. Regular Maintenance</b>	39
7.1. Keeping the Printer Clean	39
7.2. Bearings	39
7.3. Fans	39
7.4. Extruder Feeding Gear	39
7.5. Electronics	39
7.6. Extruder is Clogged or Jammed	40
7.7. Cleaning the Nozzle	40
7.7.1. The filament does not come out of the nozzle.	40
7.7.2. The filament does not come out of the nozzle or only a small amount comes out.	40
7.8. Troubleshooting Faulty Sensor Readings and Removing Errors	41
7.9. Printer Does Not Recognize the Inserted USB Drive	41

## Product Information

Name:	Magician X2
Manufacturer:	Mingda Technology limited company 3/F, No.20, Dahe Industrial Zone, Longhua District, 518110; Shenzhen, Guangdong, China.
Contacts:	E-mail: <a href="mailto:info@3dmingda.com">info@3dmingda.com</a>
Power supply:	100-240 VAC, 50-60 Hz, 350W
Operating temperaturerange:	18 °C - 38 °C
Maximum air humidity:	85%, non-condensing
Printer dimensions:	Width: 460 mm
	Depth (with bed centered): 430 mm
	Height (without filamentholder): 546mm
Build volume (width ×depth × height):	230×230×260 mm
Installed nozzle diameter:	0.4mm
Supported filamentdiameter:	1.75mm
Weight (withoutpackaging):	7.5kg

The product serial number can be found on the type label located on the right side of the printer's gantry.  
This device is intended for use in indoor environments only where it is protected against external influences.

## Warranty

The Mingda Magician X2 3D printer is covered by a 12-month warranty for end customers and business customers.

Consumables and parts subject to wear and tear are excluded from this warranty. The warranty period starts on the day the customer receives the goods. The seller is not liable for any damage caused by improper handling of the purchased product, or damage caused by handling in violation of the information and recommendations given in the official manuals and instructions. The warranty also expires in the event of unskilled interventions and the use of unofficial hardware and software modifications.

# Safety Instructions and Disclaimer

Acting in contravention of the information provided in the manual may lead to injury, poor print results, or damage to the 3D printer. Make sure that everyone working with the printer is familiarized with the content of this handbook and understands it correctly.

As we cannot control the conditions under which the Mingda Magician X2 printer is used, we do not assume any responsibility and expressly disclaim any liability for losses, injuries, damages or expenses arising out of or in connection with the assembly, handling, storage, use or disposal of the product.

The information in this manual is provided without any warranties, expressed or implied. Be very careful when handling the 3D printer. It is an electrical device with moving and heated parts.

## Placement and Basic Use

- Make sure that the printer is located and operated in a safe place to avoid potential risks.
- This device is intended for indoor use only. Do not expose the device to water or snow. Contact with water and other liquids may lead to damage to the electronics, short circuits, and other types of damage. Always operate the printer in a dry environment.
- Place the printer in a safe dry place on a horizontal and stable surface - e.g., a work table. Around the printer should be at least 30 cm of space. If there are obstacles close to the printer, it may affect its operation or cause excessive wear of the textile cable sleeves or even the cables themselves. Worn cables can pose a risk (electric shock, fire).
- Make sure that none of the vents/fans is blocked. The printer has a built-in fan speed monitoring, but in some cases (incorrect assembly, damage to components, unofficial firmware) the monitoring may not work correctly. Insufficient cooling can lead to overheating and serious damage to the printer (risk of damage to electronics, fire).
- Make sure that the printer is placed so that it cannot be toppled over or dropped to the ground. If the printer has suffered physical damage, do not use it - damaged parts of the printer may pose a safety risk.
- The power cable must be placed so that it cannot be tripped over, stepped on, or otherwise damaged. Place the printer on a stable, solid surface (e.g., a work desk). If the printer is damaged, stop using the device, turn it off immediately and contact us for assistance. Damaged cables pose a safety risk - there is a risk of electric shock or fire.
- Do not leave the printer switched on without supervision! The printer has temperature monitoring and a number of smart features for increased safety, but in the case of use contrary to the instructions in this manual or failure of components, there is a risk of fire.
- Never place anything into the printer under the heatbed - the heatbed is a moving part and could crash into objects underneath it!

## Electrical Safety

- The printer should only be powered through a standard 230 VAC, 50 Hz or 110 VAC, 60 Hz outlet. Never use alternative power sources as they can cause problems or damage the printer.
- Do not use the printer if the power cord is damaged in any way – damaged cords can lead to electric shock.
- When disconnecting the power cord from the outlet, pull the plug, not the cord, to reduce the risk of damaging the plug or outlet.
- Never disassemble the power supply of the printer as it contains no parts that can be repaired by an untrained worker. Always take the printer to a qualified service technician for repairs. Improper interventions in the power supply may lead to damage to the printer and an increased risk of electric shock.
- The device is disconnected from the power supply by pulling out the plug. The electrical outlet must be easily accessible.

## Mechanical Risk

Moving mechanical parts of the printer can cause injury.

- Never interfere with the inner components of the printer when it is connected to the power supply or running – there is a risk of injury from mechanical parts or electric shock.
- Prevent children from manipulating the printer without the supervision of an adult – even when the printer is not printing.

## Burn Risk

- Do not touch heated parts of the printer – heatbed, print plate, and parts of the printhead. There is a risk of burns.
- Warning! During printing, parts of the printhead and the print plate can heat up to very high temperatures! Do not touch them until the printing ends and the printer cools down – otherwise, you may get burned.

## Proper Use of Glass Printing Sheets

Each type of print sheet requires slightly different maintenance. Improper handling and use can lead to damage to the print sheet, heatbed or other parts of the printer. Print sheets are consumable and subject to wear.

- To degrease the sheet's surface, use highly concentrated isopropyl alcohol (90% or higher).
- Do not use products that contain IPA as one of the components (e.g. hand sanitizers) - these products usually contain other additives that may negatively affect the properties of the printing plate.
- If the sheet is dirty, clean its surface with an isopropyl alcohol-dampened wipe before you start printing.

## Working with Filaments

When handled correctly, working with filaments is straightforward and safe.

**Please read the following recommendations.**

- Always use the recommended temperatures for the selected material.
- Beware of molten plastic - it can cause burns! If there is molten plastic stuck in the nozzle, do not remove it by hand - use pliers or other tools.
- Some materials may emit a strong odor when printing - regularly ventilate the room.
- Handle the filament according to the instructions on the following pages of the manual.
- Always make sure that the end of the filament is properly secured (either in the extruder or in the spool). If you accidentally release the end of the filament, it may easily tangle up and create knots.



# 1. Introduction

Thank you for purchasing the Mingda Magician X2 3D printer from MINGDA! Your support allows us to invest in further development of 3D printers and any other projects of 3d printing.

**Magician X2:** simple operation, easy maintenance, heatbed with Glass printing sheets, filament sensor, high-quality PSU, long-term support and many more. Still, **roughly 80% of all parts have been changed.**

## 2. Unpacking and Package Contents

The printer is 90% fully assembled model, simply remove the top foam inlay from the box. Find a good place for the Magician X2. **You need at least 570x450mm of space for the printer to operate.** Keep in mind that the heatbed moves back and forth during printing and **the cables must not hit a wall** when the heatbed is in the rearmost position. Grab the top part of the metal frame and lift the printer from the box - **see the chapter below: How to Move the Printer.**

### 2.1. How to Move the Printer

If you want to move the Mingda Magician X2 printer, use the recommended method - **grab the top of the printer frame and lift the printer.** Never lift the printer by the cables, filament holders or X-axis.



## 2.2. Contents of the Package and Accessories

The latest version of this handbook can be found at

<https://3dmingdaofficial.com/pages/magician-firmware-driver-and-video> in PDF format.

If you encounter any problems while using the printer, do not hesitate to contact us at [support@3dmingda.com](mailto:support@3dmingda.com).

We will be happy to answer your questions or hear your ideas for improvement.

### What's in the box

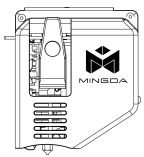

Extruder

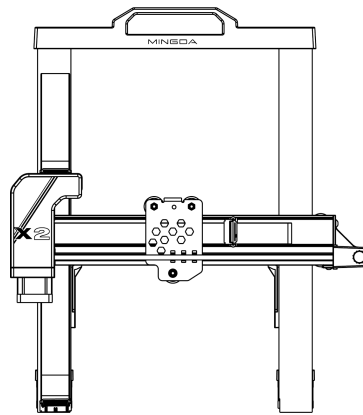

Gantry

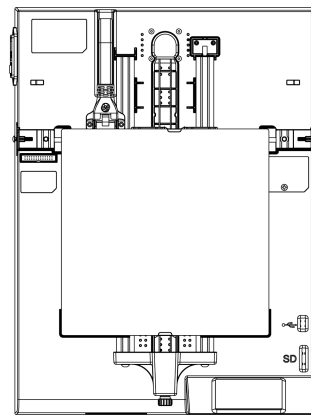

The Main Chassis

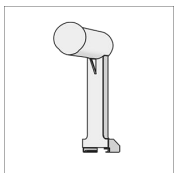

Filament holder



User manual

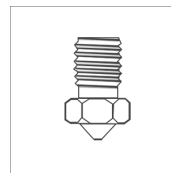

Nozzle

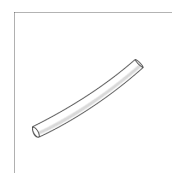

Teflon tube

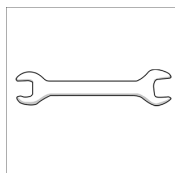

Wrench

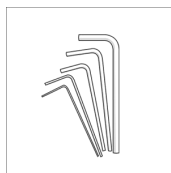

Allen wrench

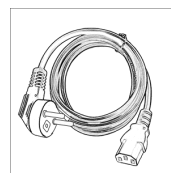

Power cable

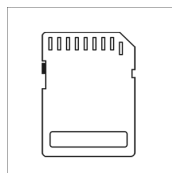

SD card

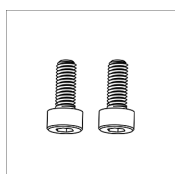

M3\*8 (2pcs)

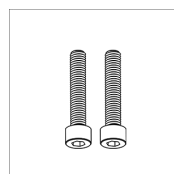

M5\*25 (2pcs)

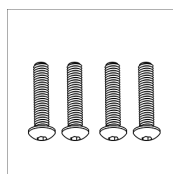

M4\*20 (4pcs)

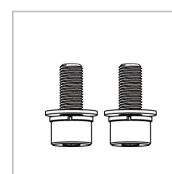

M4\*10 (2pcs)

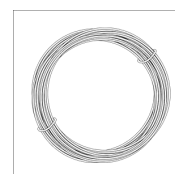

Filament

# 3. Magician X2 Overview and Glossary

## 3.1 Product Display

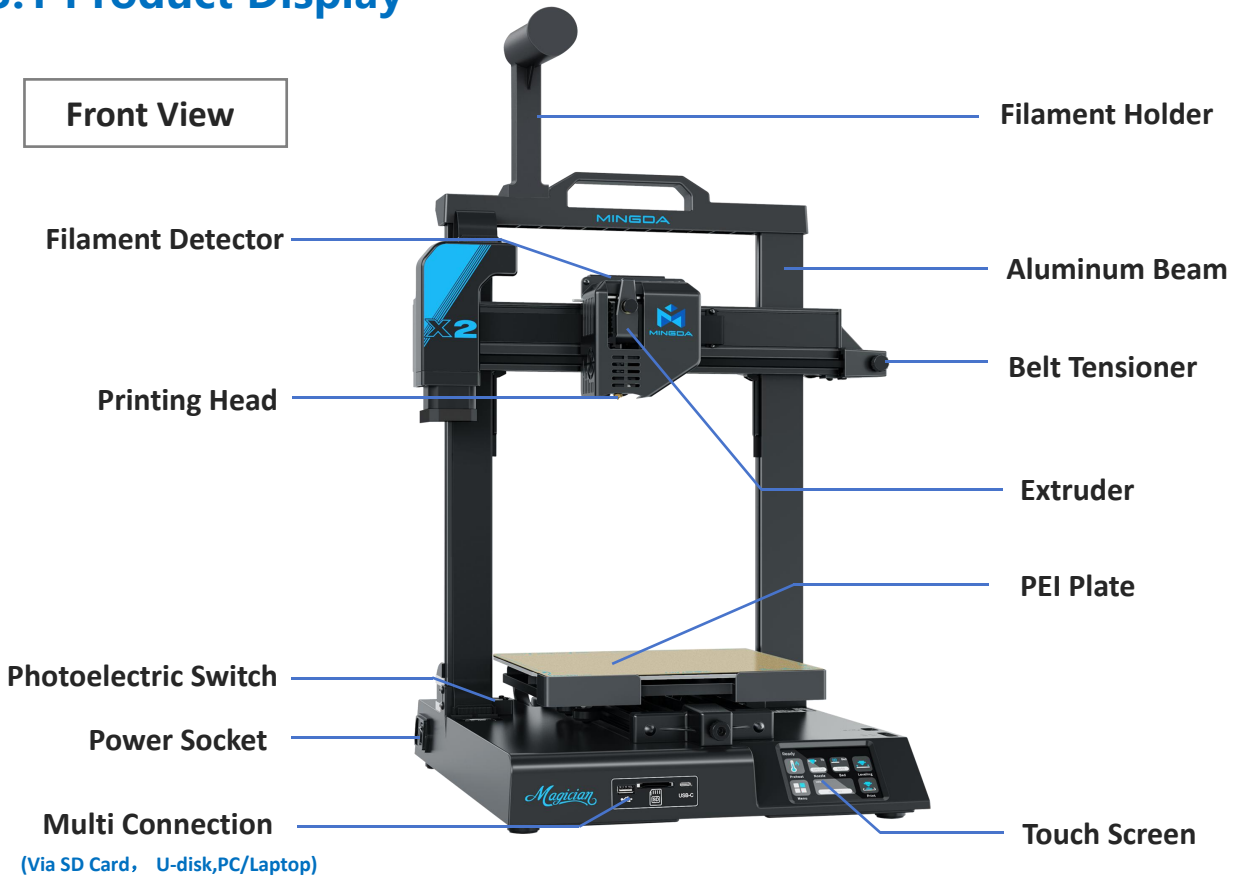

**Back View**

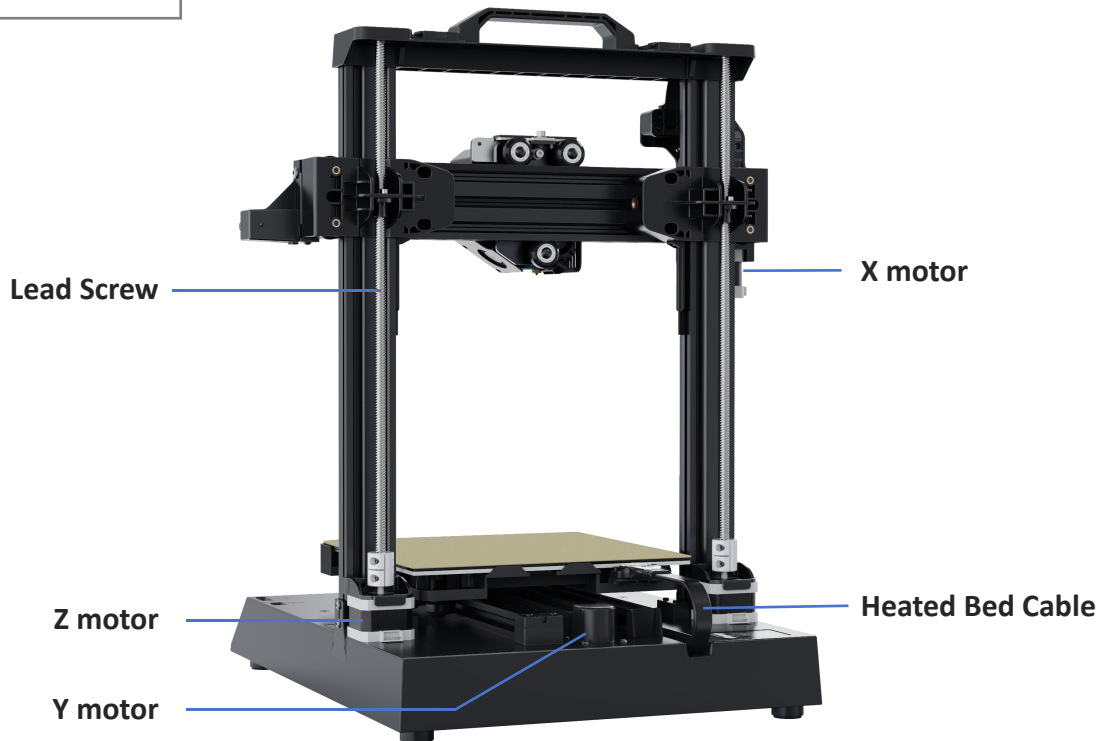

## 3.2. Connecting and Disconnecting the Power Cable



Always pull the connector, do not pull on the cable itself! Incorrect handling can lead to damage to the connector or cable.

The power supply port is located on the left side of the printer. Before you plug or unplug the cable, turn the printer off using the physical switch on the power supply unit next to the power supply port. See the picture below to learn how to correctly disconnect the power plug from the power supply.



## 4. Your First Print

To get your printer up and running, please pay attention to the information in the following chapters. We will go through the basics together - you'll be printing in no time!

### In this chapter you will learn how to:

- Control the printer
- Perform level calibration
- Insert filament
- Start the first print
- Remove the print
- Troubleshoot basic issues
- Update the firmware

# 4.1. Machine Operation

All configuration steps and overall control of the printer are done with touching screen. We will show you the operation interface of the printer and Glossary.

## In printing process main interface

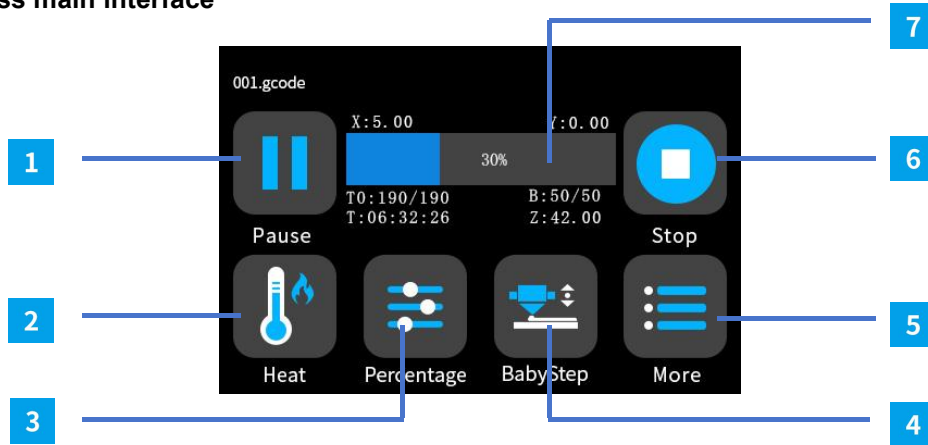

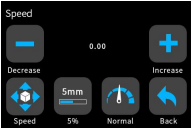
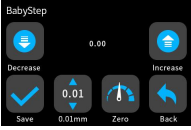
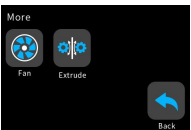
	Primary interface	Secondary interface and Explain
1	<b>Pause</b>	Pause the printing process
2	<b>Heat</b> 	Decrease "-": Decrease the temperature Increase "+": Increase the temperature Nozzle/Hotbed: Option to change the nozzle and bed °C : 1 °C, 5°C, 10°C for option Stop : Stop heating the nozzle/bed Back: Back to last step
3	<b>Percentage<sup>1</sup></b> 	Decrease "-": Decrease the Speed/Flow Increase "+": Increase the Speed/Flow Speed/Flow : Option to change the speed/Flow % : 1%, 5%, 10% for option Normal: None Back: Back to last step
4	<b>Baby Step<sup>2</sup></b> 	Decrease ↓: Decrease nozzle distance to the hotbed Increase ↑: Increase the nozzle distance to the hotbed Save: Save the Z-off set setting mm: 0.01mm, 0.1mm, 1mm for option Zero: Reset the BabyStep set to 0 Back: Back to last step
5	<b>More</b> 	Fan <sup>3</sup> : option to stop or decrease/increase the fans speed Extruder: While printing is paused, Option to see the materials loading speed and flow. (Materials run out and reload the new materials choose this option in printing process)
6	<b>Stop</b>	Cancel the printing process
7	<b>Process bar</b>	Show the printing process time/percentage

# Pre-printing Main Interface

Ready

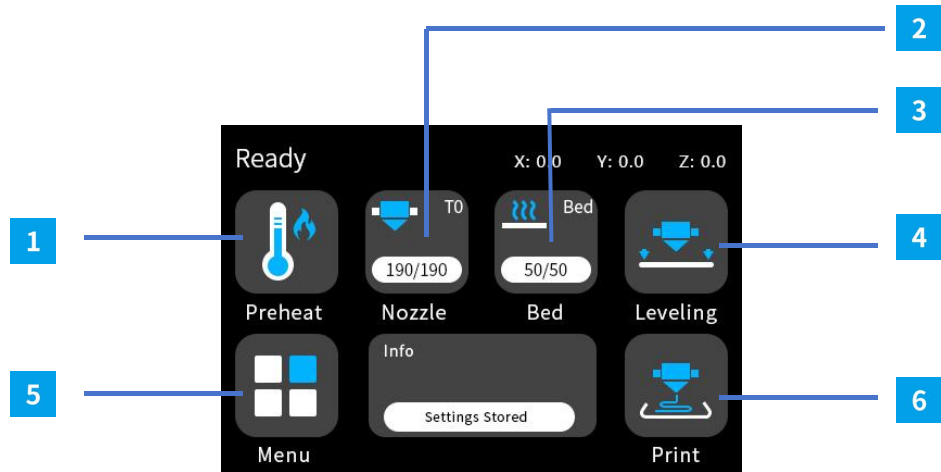

	Primary interface	Explain
<b>1</b>	<b>Preheat</b>	Pre-set nozzle & hotbed's temperature, turn to page [15]
<b>2</b>	<b>Nozzle</b>	Pre-set nozzle's temperature, turn to page [15]
<b>3</b>	<b>Bed</b>	Pre-set hotbed's temperature, turn to page [16]
<b>4</b>	<b>Leveling</b>	Autoleveling (No other operations shall be done during auto leveling)
<b>5</b>	<b>Menu</b>	Printer's printing value adjustment,turn to page [17]
<b>6</b>	<b>Print</b>	Start print, turn to page [16]

### Pre-heat

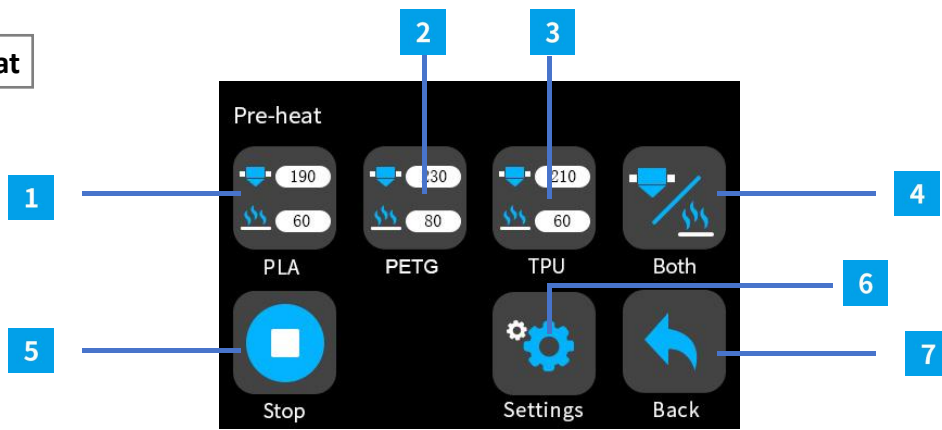

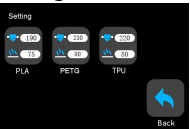
	Secondary interface	Explain
<b>1</b>	PLA	Pre-set temperature for PLA
<b>2</b>	PETG	Pre-set temperature for PETG
<b>3</b>	TPU	Pre-set temperature for TPU
<b>4</b>	Both	Option Nozzle/hotbed only or Both
<b>5</b>	Stop	Stop the heating process
<b>6</b>	Setting 	For customize Pre-set temperature for Nozzle and hotbed
<b>7</b>	Back	Back to last step

### Nozzle

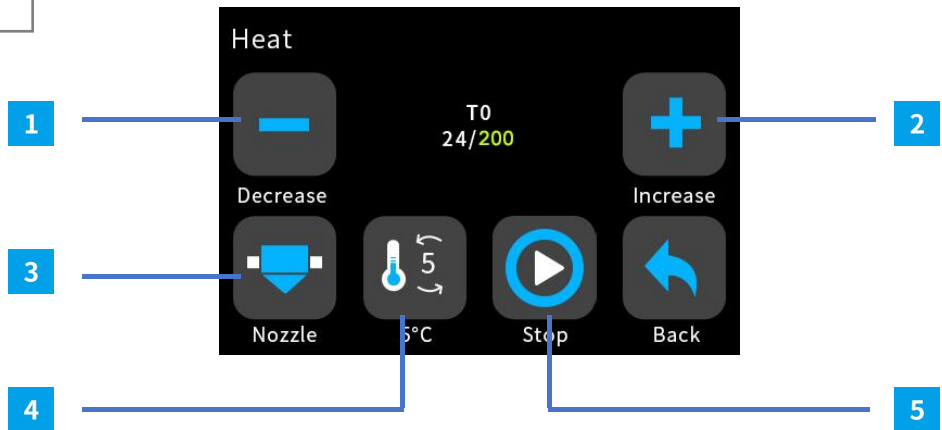

	Secondary interface	Explain
<b>1</b>	Decrease "-"	Decrease the temperature
<b>2</b>	Increase "+"	Increase the temperature
<b>3</b>	Nozzle/Hotbed	Option to change the nozzle and bed
<b>4</b>	°C	1 °C, 5°C, 10°C for option
<b>5</b>	Stop	Stop heating the nozzle/bed

**Bed**

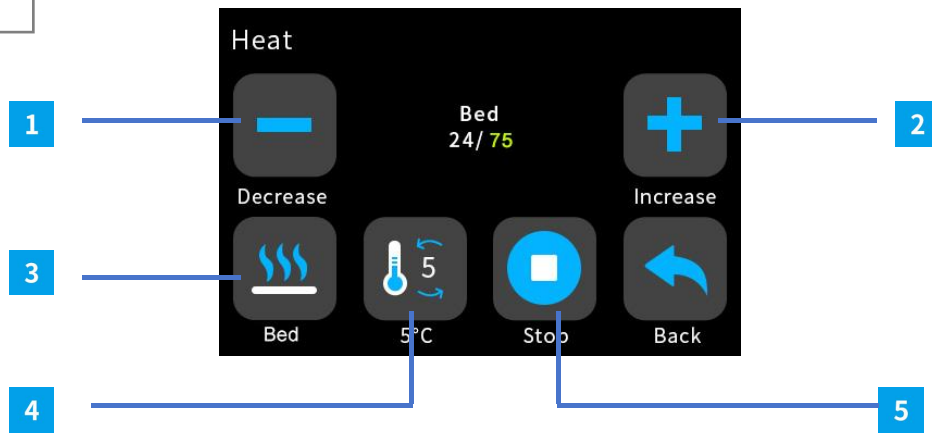

	Secondary interface	Explain
1	Decrease "-"	Decrease the temperature
2	Increase "+"	Increase the temperature
3	Nozzle/Hotbed	Option to change the nozzle and bed
4	°C	1 °C/5°C/10°C for option
5	Stop	Stop heating the nozzle/bed

**Print**

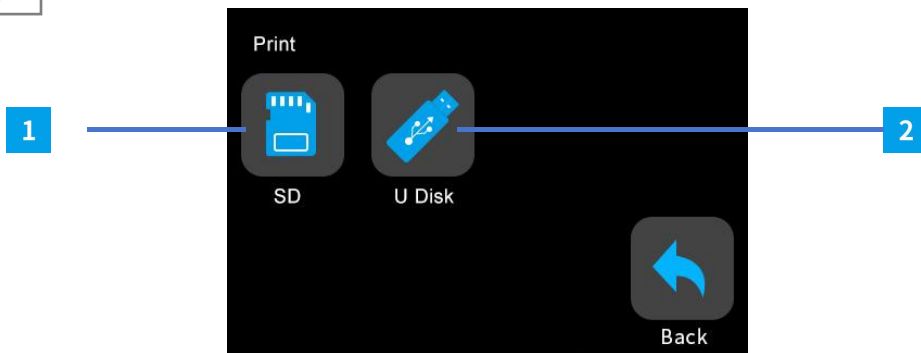

	Secondary interface	Explain
1	SD card	Select SD card's Gcode
2	U Disk	Select USB's Gcode



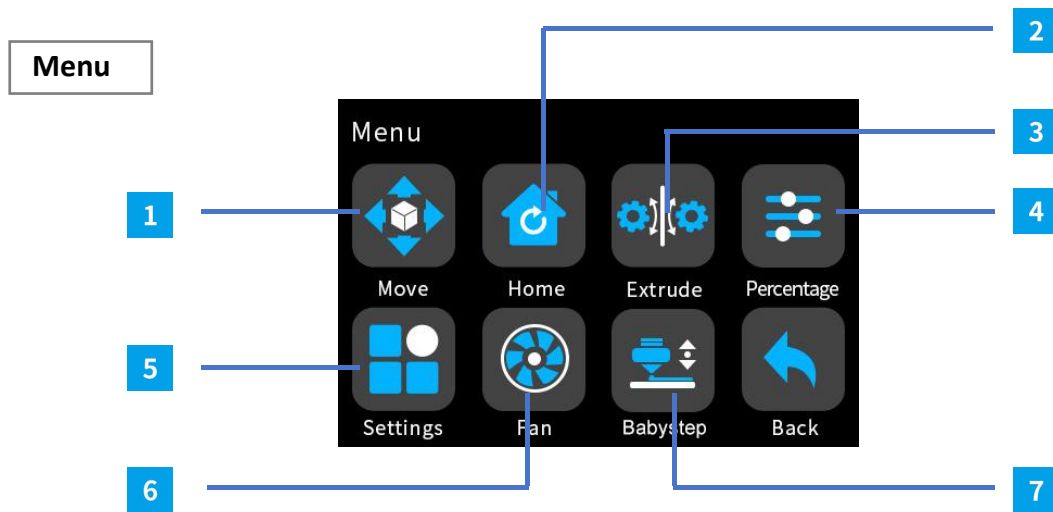

	Primary interface	Explain
<b>1</b>	<b>Move</b>	Adjust X, Y, Z Axis' Value, turn to page[18]
<b>2</b>	<b>Home</b>	Reset X, Y, Z Axis' Value, unlock motor, turn to page[18]
<b>3</b>	<b>Extrude</b>	To unload or load filament, turn to page[19]
<b>4</b>	<b>Percentage</b>	Adjust Printing speed & flow Value, turn to page[19]
<b>5</b>	<b>Settings</b>	More printer setting, turn to page[20]
<b>6</b>	<b>Fan</b>	Adjust cooling system's Value, turn to page[21]
<b>7</b>	<b>Babystep</b>	Adjust Z offset's Value, turn to page[21]

**Move**

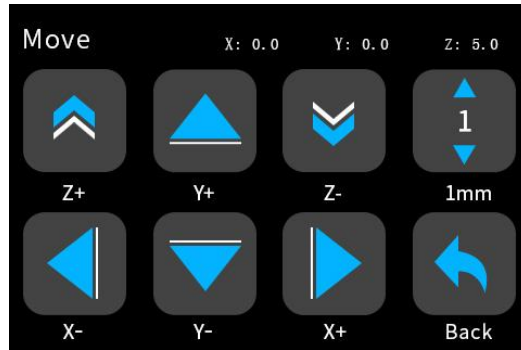

Secondary interface	Explain
X+,X-	Adjust X axis (Right & Left)
Y+,Y-	Adjust Y axis (Forward & Backward)
Z+,Z-	Adjust Z axis (Up & Down)
mm	0.1/1/10 Movement distance

**Home**

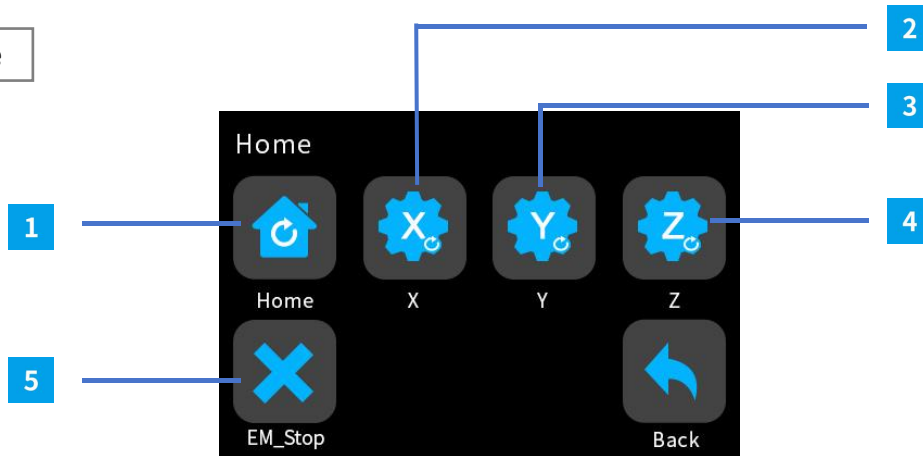

	Secondary interface	Explain
1	Home	Reset to 0
2	X	Set X to 0
3	Y	Set Y to 0
4	Z	Set Z to 0
5	Em.stop	Motor Unlock

**Extrude**

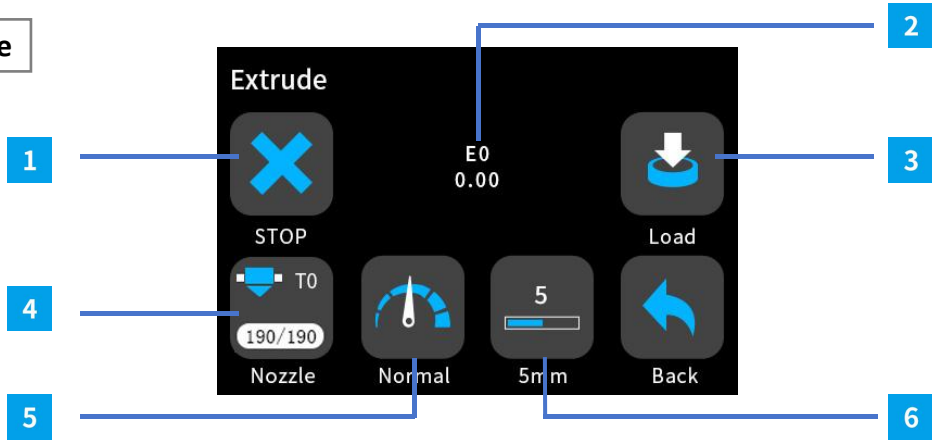

	Secondary interface	Explain
1	Stop	Stop feeding out filament
2	E0	Display the distance of feeding out
3	Load	Start feed out filament
4	Nozzle	Display nozzle temperature
5	Normal	Flow speed slow, normal, fast
6	mm	Distance of feeding out

**Percentage/ Speed**

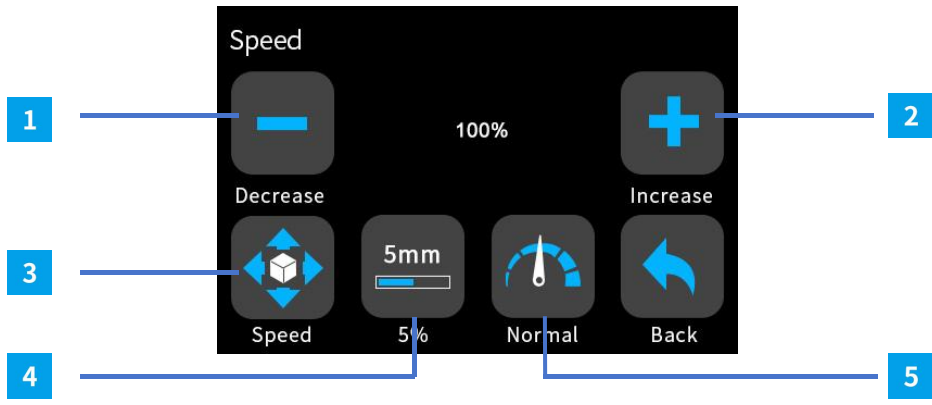

	Secondary interface	Explain
1	Decrease "-"	Decrease the printing speed
2	Increase "+"	Increase the printing speed
3	Speed	Switch to Flow
4	5%	Adjust rate
5	Reset	Reset to initial speed

## Percentage/ Flow

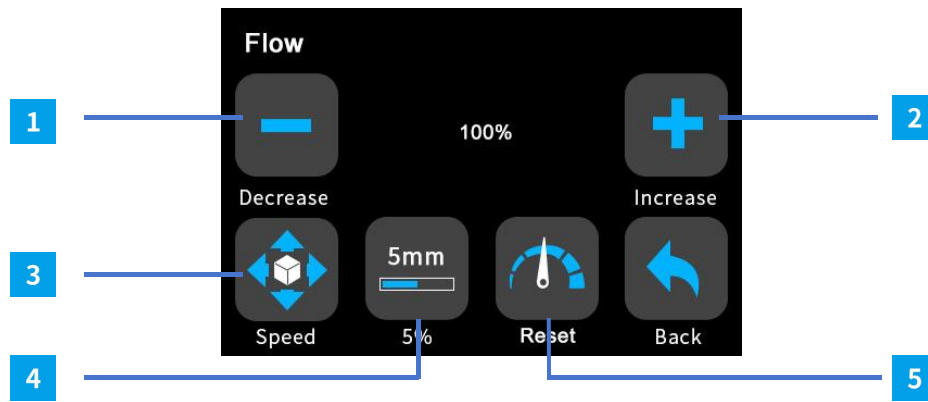

	Secondary interface	Explain
1	Decrease "-"	Decrease the flow rate
2	Increase "+"	Increase the flow rate
3	Flow	Switch to Speed
4	5%	Adjust rate
5	Reset	Reset to initial speed

## Settings

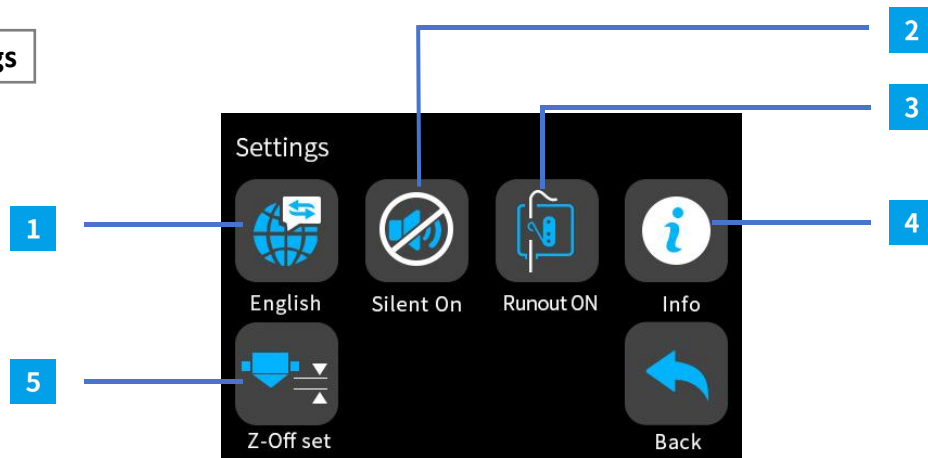

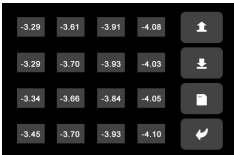
	Secondary interface	Explain
1	English	Switch to other language
2	Silent ON	Switch On/off buzz of printer
3	Runout On	Switch On/off filament detector
4	Info	Printer's information
5	Z-Offset 	Manually adjust the Z offset value

## Fan

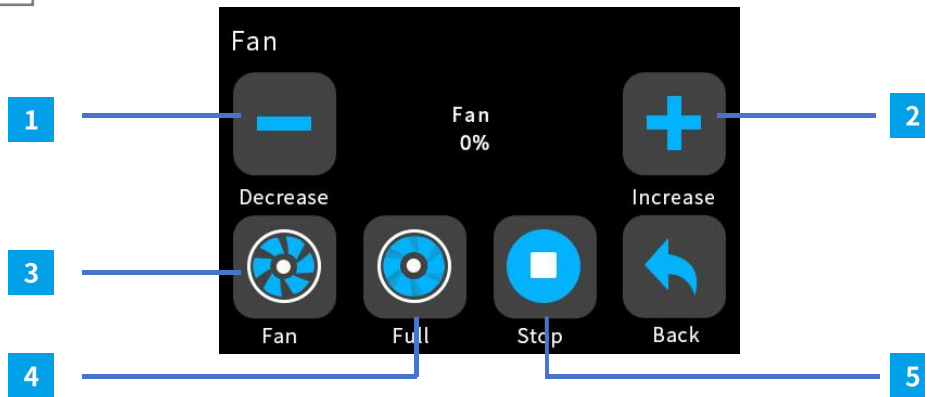

	Secondary interface	Explain
1	Decrease "-"	Decrease the Fan rate
2	Increase "+"	Increase the Fan rate
3	Fan	Switch to Fan1
4	Full	100% Fan rate
5	Stop	Stop fan working

## Babystep



	Secondary interface	Explain
1	Decrease	Decrease the distance between nozzle and plate
2	Increase	Increase the distance between nozzle and plate
3	Save	Save the current setting
4	0.01mm	Movement distance
5	Zero	Return Babystep to zero

## 4.2. Print Sheets

Make sure there is no debris on the heatbed before you install the print sheet. It could either throw off the first layer calibration or possibly even damage your printer.

Mingda Magician X2 comes standard with a single-side **PEI print sheet** or **Glass print sheet**. If you have a different type, we recommend that you carefully study how to properly treat the surface in the Regular Maintenance chapter.

### For PEI print sheet

It consists of two layers in total. One layer is a single-sided PEI metal sheet, and the other layer is a magnetic sticker.

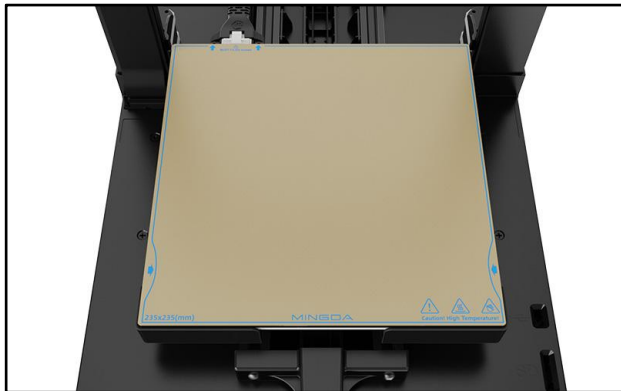

### For Glass print plate

You need to remove the thin film on the glass, it has been inserted into two buckles of the aluminum build plate

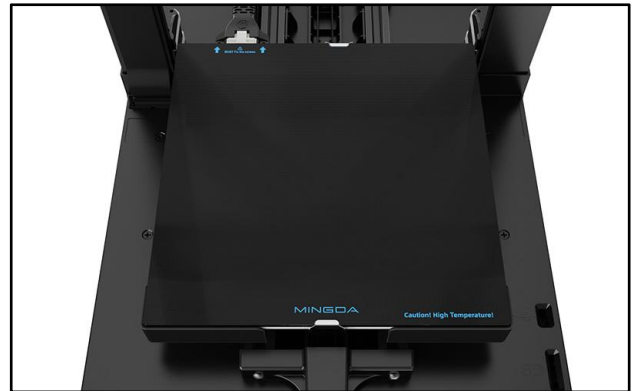

Both print platforms have been pre-installed for you before leaving the factory, so you do not need to install it again.

For your first print, make sure not to touch the surface of the sheet, You can print on your plate directly.

**Important:** The adhesion of the glass is particularly strong, so if you are printing for the first time, it can be challenging to remove the model, and this is a normal phenomenon. You can wait for the heated bed to cool down before attempting to remove the model. Additionally, as the number of prints increases, the adhesion of the glass will gradually decrease, eventually reaching a normal situation.

## 4.3. Inserting (Loading) filament

First, prepare a spool of filament - **we strongly recommend using PLA** because it's easy to work with. Take the spool, make sure the end of the filament is properly secured and place the spool onto the spool holder on top of the printer's frame.

**Carefully unhook the end of the filament strand** and make sure not to let go, otherwise, the tension in the strand would cause the filament to quickly tangle up.

1. Tap Preheat, select the material you need.
2. In order to feed filament smoothly, Please keep the end of the filament at 90°. Push the filament through the hole in the filament guide and insert the plastic strand into the opening at the top of the extruder.
3. wait until the nozzle reaches the desired temperature.
4. Select the Menu - Extruder, adjust the distance to 10mm, tap load with 6-7 times.
5. Push the filament into the extruder lightly until you feel that the extruder gear grabbed the filament and is pulling it in.
6. The feed wheel in the extruder will then feed the filament further into the extruder.

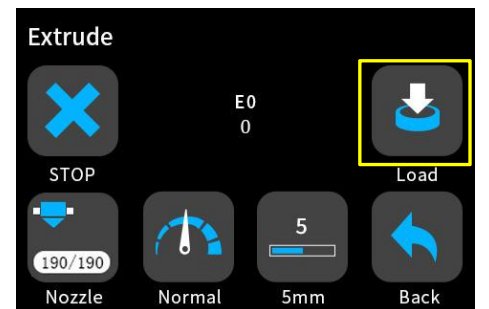
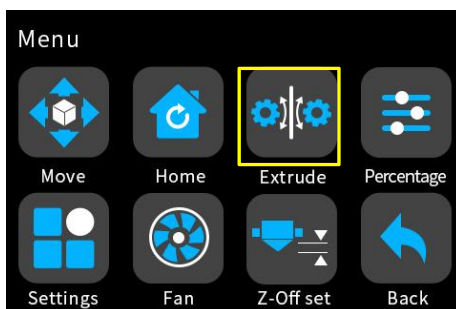
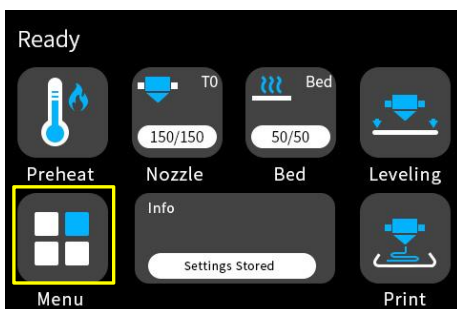
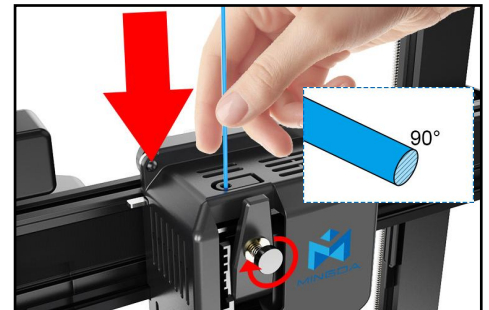
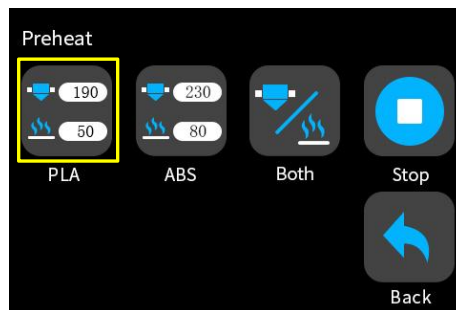
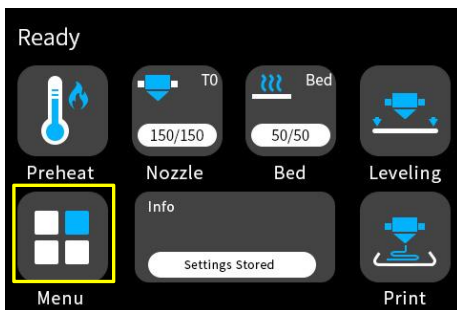

For the next step (Starting the First Print), leave the filament inserted in the printer. If for any reason you need to change the filament, the procedure is described on the next page.

## 4.4. Unloading (Removing) Filament

1. Select Menu - Extrude-Unload
2. The printer will preheat automatically. As soon as it reaches the right temperature, the filament will be unloaded from the extruder in a few seconds.
3. Once the extruder stops unloading the filament, remove it from the extruder by hand. The filament needs to be wound up on the spool and secured carefully so that it does not tangle up.

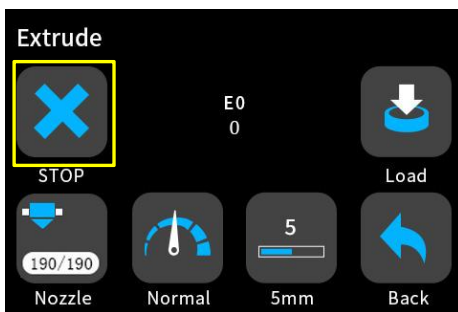
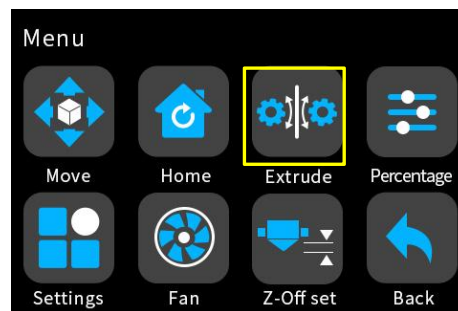
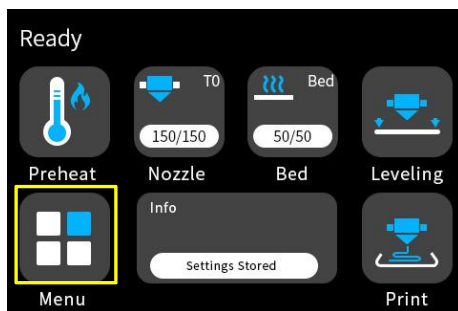

## Tangled filament? Let's fix it!

If you accidentally manage to let go of the end of the filament and the strand quickly retracts onto the spool, it's possible that the filament became tangled. This poses a risk during printing a knot can form on the strand of filament, which will inevitably lead to a failed print. Simply remove the spool from the spoolholder and start unwinding the filament strand from the spool until you find the crossed section. Fix it and wind the filament back onto the spool.



## 4.5. Starting the First Print

**First performs Mesh Bed Leveling - Tap ABL**, the nozzle will check the distance to the print sheet in several places to create a virtual height map of the surface. This allows the printer to lay down a perfect first layer every time. Subsequently, the printing of the object or objects will take place.

**Then select one of the test objects from the Print menu (only appears if a SD card is inserted).**

Watch the printer closely during the first print. We recommend selecting the Rabbit. It gives you a good quick overview of whether everything is properly set up. **The nozzle will first preheat to 190 °C independently** of the selected filament - the temperature is lower to prevent the filament from dripping from the nozzle.

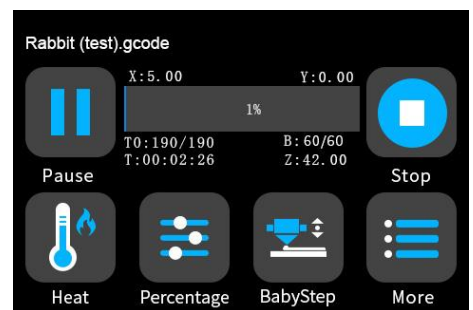
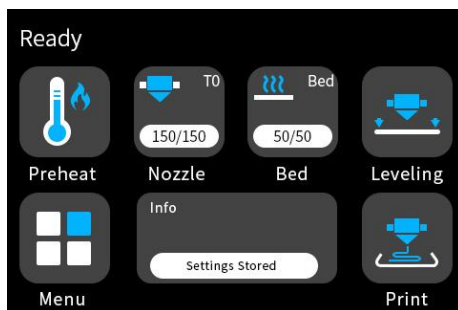
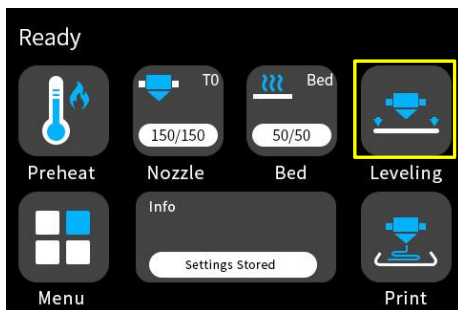

Carefully observe the quality of the first layer. The Magician X2 is equipped with very accurate leveling sensor technology, which measures the distance between the nozzle and the bed with Perfect accuracy.

However, it may happen that due to, e.g., traces of grease, the print may not hold well.

If you find that the plastic is peeling off the bed, stop the print by selecting the Stop print icon on the screen. Clean the bed and try again.

If the first print fails repeatedly, go to the First Print Troubleshooting chapter, where you will find useful tips and tricks.

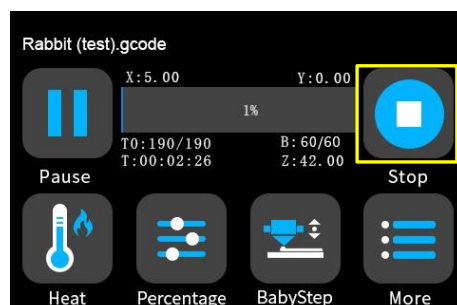

## 4.6. Removing a Printed Object from the Print Sheet

Once the print job is finished, wait until the print sheet cools down. The print plate and heated bed may exceed 100 °C, depending on the settings - contact with unprotected skin can cause burns, so check the heatbed temperature in the footer of the LCD screen!

Depending on the type of material, it may happen that the print will separate from the print sheet automatically by itself after cooling. Be sure to remove all pieces of plastic - don't forget the priming line next to the print.

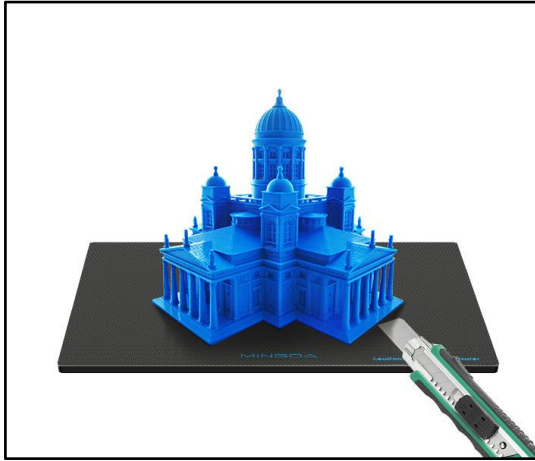

For **Glass**, you can use blade, Slowly pry the edges of the model till the model was loose.

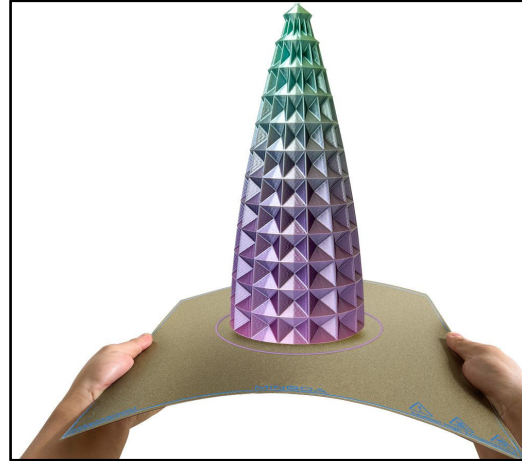

For **PEI** you can remove the print plate and carefully bend it on both sides. Then turn it by 90° and repeat the bending.

If there are plastic remnants on the plate, do not remove them with your nails, you could get injured. Use a plastic spatula to remove the remaining plastic.

Try not to touch the print surface with your fingers - fingerprints are greasy and can reduce adhesion.

## 4.7. First Print Troubleshooting

During your first printing, if a printing issue does occur, it usually falls into one of the following scenarios:

### 4.7.1. First layer peeling off from the bed

**Solution: The most common cause is grease on the bed or an unsuitable combination of material and print surface (e.g. PLA and textured sheet).**

Make sure that the sheet is sufficiently **degreased using isopropyl alcohol** - more information can be found in the **Regular Maintenance chapter**. In the **Materials chapter**, you can find information on how to properly print specific filament types. Water with a bit of dish soap is also an option if you don't have access to IPA - **make sure to clean and dry the sheet thoroughly to prevent rusting.**

## 4.7.2. Nozzle moves too high/low, or extrudes plastic outside the print area

**Solution:** Make sure if the print plate is dislocation and that nothing is blocking the X/Y/Z axes.

If the print sheet is not installed properly (e.g., it's not aligned with the heatbed), it may cause various printing issues. **Make sure that nothing is obstructing the movement of the axes** and that all packaging material and transport fixations have been removed from the printer.

Another possibility is that the leveling sensor is not performing as expected. **Repeat the ABL from the menu.**

If it still doesn't work, **please use baby-step function during the printing.** Select Decrease if the nozzle is too high, select Increase if the nozzle is too low. Normally the adjustment distance is within 0.15.

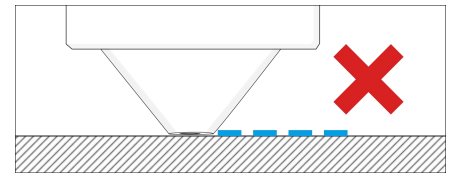
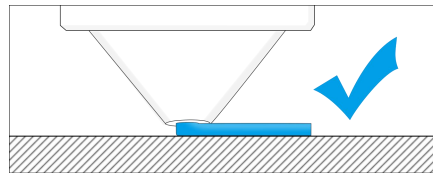
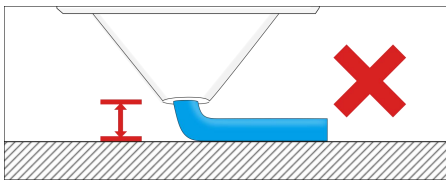
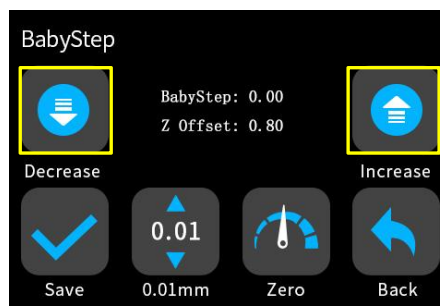
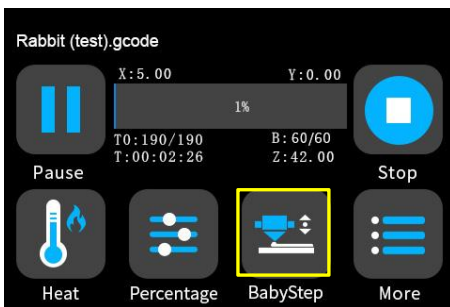

### 4.7.3. The nozzle does not start extruding, even after multiple attempts

**Solution:** Make sure that the filament can reach the extruder gear inside the extruder and that the nozzle is not clogged.

First of all, **load the filament exactly** as described in the Loading the Filament chapter. Once the loading procedure is completed, **loose the knob screw**, then flip the door open and **see if the filament strand reached the large extruder gear**. If it didn't, it means that something is blocking the movement of the filament.

If the filament appears completely loaded (it goes across the extruder gear towards the nozzle), **it means the nozzle might be blocked**. This won't happen with a new printer, but if you have been using it for a while, it might be a possibility. **If you hear the extruder gear clicking during Purging, it may be a sign the nozzle is blocked**. Please contact our after-service for help: [support@3dmingda.com](mailto:support@3dmingda.com).



### 4.7.4. After a few hours of printing, the nozzle stops extruding filament

**Solution:** First, check if the filament isn't tangled. If it's not the case, unload it, wait for the printer to cool down and then remove the hotend from the extruder and check if the steel filament guide isn't deformed.

This might happen when you overtighten the knob screws. Another possibility is that the nozzle is clogged or blocked. Please contact our customer service for help.

## 4.8. Updating the Firmware

The Mingda Magician X2 is ready to print once assembled and powered on. To make sure you have the most up-to-date version of the firmware with the latest features and settings, we recommend checking

<https://3dmingdaofficial.com/pages/magician-firmware-driver-and-video>

**To check your firmware version, navigate to Menu-Setting-Info.**

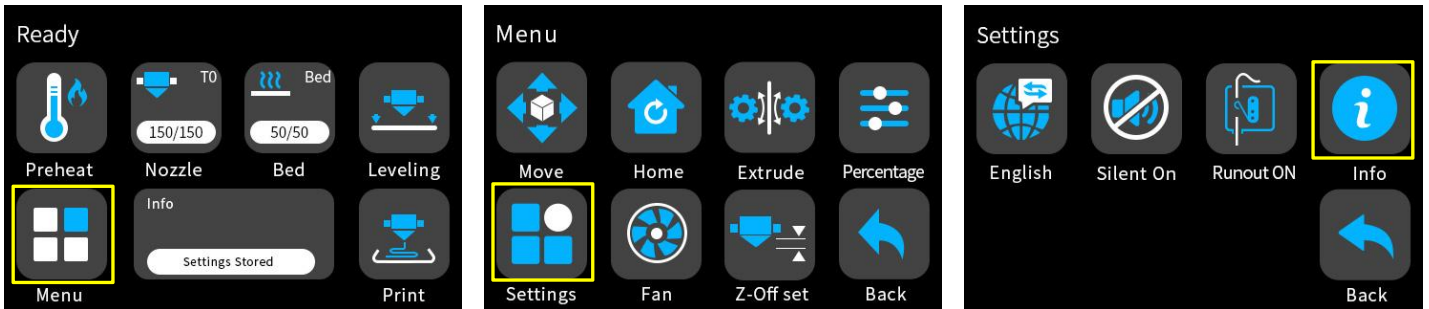

**To update your printer's firmware, follow these instructions:**

1. Download the correct version of the firmware from <https://3dmingdaofficial.com/pages/magician-firmware-driver-and-video> and unzip the file.
2. Copy the **.bin** file to a SD card formatted with FAT32 - you can use the SD card that comes with your Magician X2.
3. Insert the SD card into the printer and restart the device
4. The update process should begin automatically.
5. Wait until the process is completed.



To force a firmware installation (e.g. if you need to load an older firmware), insert the SD card containing the desired **.bin** file, restart the printer. Once you finished the update whatever older or newest firmware, please delete the firmware file in your SD card.

## 4.9. Sample Models

The **SD Card** that came with your MINGDA Magician X2 3D printer contains **some sample files (G-codes)**. We recommend keeping them on the PC drive.

These files have been prepared (sliced) and thoroughly tested by us. **If you encounter issues with print quality at any time, try loading and printing one of the sample files.**

If your own custom print fails and the sample files are printed correctly, it means there's probably an issue with the way your files are sliced. Try reslicing them again with the default Mingda cura settings and check for the basic issues:

- Incorrect printer/nozzle profile (the Magician X2 is equipped with a 0.4mm nozzle by default)
- Incorrect material settings
- Missing supports
- Incorrectly configured infill
- The model is not in contact with the print sheet

**If the sample files are not printed correctly**, check the Troubleshooting section, or contact our tech support.

## 5. Printing Your Own Models

Once you manage to successfully print your first sample object. printing your own models, slicing - all this (and more) is covered on the following pages.

Our Magician X2 should be now fully calibrated and the first print was a success. And now, you want to print your own model - be it something you already modeled, or something you downloaded from the internet.

**Here's a little catch:** it's not possible to print models downloaded from the internet directly. Before you can print a model, you need to prepare it for the printer - we call this process "slicing". Generally speaking, you need to tell the printer what should be inside the printed object (infill), how detailed the model should be and a couple of other things. Plus, you need to keep in mind several things like the stability or durability of the print.

We'll go through the process with you. We'll introduce Mingda Cura slicer software and tell you the basics about slicing.

### To summarize:

- Find a suitable 3D object for printing and download it (usually in **.stl** or **.obj** format)
- Import the object into Mingda cura slicer
- Select the nozzle diameter (default is 0.4mm) and layer height
- Use the built-in tools to scale, move and rotate the object. Find the optimal orientation:
  - 1.Large flat base
  - 2.Minimal overhang angles to reduce the number of supports required for printing
  - 3.If supports are necessary, try to rotate the object so that the supports are not in direct contact with areas that need to have top print quality (e.g., the face of a statue)
- Select the infill type and density
- Slice the object
- Inspect the preview
- Export the G-code and print it

## 6. Obtaining Printable Models

**The easiest way to start with 3D printing is to download models from the internet - they are usually in .3mf, .stl or .obj formats.** Luckily, there are many enthusiasts in the 3D printing world, so a large number of 3D models are available for free. You can download anything from a simple die to detailed figures from your favorite games, movies, and series; mechanical parts, RC accessories, various household items, and even massive complex projects.

Models are usually available to download either for free under the Creative Commons - Attribution - Non-Commercial License (models cannot be used commercially and must always include the author's name), or for a small fee. We have selected the most interesting websites for you:

- [www.thingiverse.com](http://www.thingiverse.com)
- [www.myminifactory.com](http://www.myminifactory.com)
- [www.pinshape.com](http://www.pinshape.com)
- [www.printables.com](http://www.printables.com)
- [www.youmagine.com](http://www.youmagine.com)
- [www.shapeways.com](http://www.shapeways.com)
- [www.gambody.com](http://www.gambody.com)



Keep in mind that models in .stl, .obj, etc. formats cannot be printed directly. First, these files need to be "sliced" (prepared for printing), which results in a G-code file. This file contains the actual instructions for the printer. You place the G-code on a SD card or USB disk and then insert it into the printer. Then you just start printing. You will find out more in chapters What is a G-code file?



## 6.1. Create Your Own Model

**To create your own 3D model, you need a special program - a 3D editor.**

There is a wide range of different programs available, so you can choose the one that best meets your needs. To get started, the best option is Tinkercad ([www.tinkercad.com](http://www.tinkercad.com)) - an online editor which runs in your browser window, with no installation required. It is free, intuitive and there are a lot of tutorials available online. Tinkercad is mainly focused on the creation of less detailed and larger (mechanical) parts, ideal for FFF/FDM printing. Your Magcian X2 will have no problems printing them.

Another popular tool is Autodesk Fusion 360 ([www.autodesk.com/products/fusion-360](http://www.autodesk.com/products/fusion-360)) for PC, Mac and iPad. On the web, there is a simple guide available along with a lot of detailed video tutorials, making it an ideal choice for both beginners and professionals.

## 6.2. What is a G-code File?

**3D models you have either created or downloaded from the internet need to be converted from their original format (.stl, .obj, .3mf, etc.) into a file containing specific instructions for the printer - the G-code.**

This is the format that 3D printers can understand. This file contains instructions about the movement of the nozzle, the amount of filament to be extruded, temperature settings, fan speeds and more. There are dozens of different slicers available, each with its own advantages and disadvantages. We suggest using our **Mingda Cura slicer**.

## 6.3. Mingda Cura slicer Interface Explained

If you are the first time to download our Slicer, you need to select Mingda Magician X2 as your first profile.

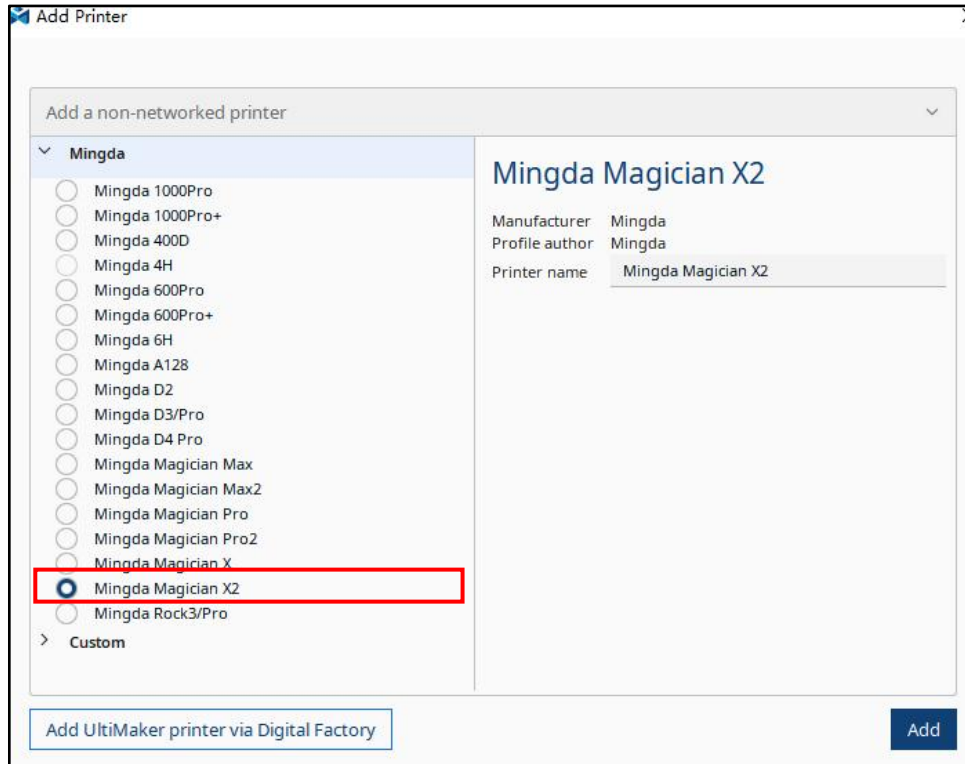

Then select the layer height, infill and the material you intend to use. If you are not sure about the layer height, stick with **0.2mm profiles** as they give generally good results.

**Recommended infill values are between 5-20 %** but it heavily depends on the model and how durable it needs to be. More infill means a more durable model, however, it will take longer to print and more material will be consumed. For general use, there is no point in going above 40% infill, unless your project really requires it.

### 6.3.1. Initial Setup and General Workflow

Cura allows you to import objects such as STL, OBJ, X3D, 3MF as well as image file formats such as BMP, GIF, JPG, and PNG

You can either drag them directly into the 3D editor window or use the Add... button from the top bar. **To modify the model, use the tools on the left sidebar, i.e. Move, Scale and Rotate.** If the object has streaks, it means it does not fit into the print bed and it needs to be moved or scaled down.

There is no universal way to place the model on the bed, it always depends on the specific shape. However, a general rule is that the bigger the flat surface of the model that touches the bed, the better it will hold - so try to **position the largest flat surface of the model downwards.**

## 6.3.2. Using Supports



Supports are printed structures resembling scaffolding. They are used for printing complex objects. After printing, they can be easily separated from the output.

You can find a large number of objects that can be printed without supports - just place them in the right orientation on the bed, slice them and you can print. **Not all objects, however, can be printed without supports.**

If you are printing an object with walls that rise at an angle less than 45°, these overhangs will cause issues with print quality. **Also, keep in mind that the printer cannot start printing mid-air.** In such cases, supports are necessary.

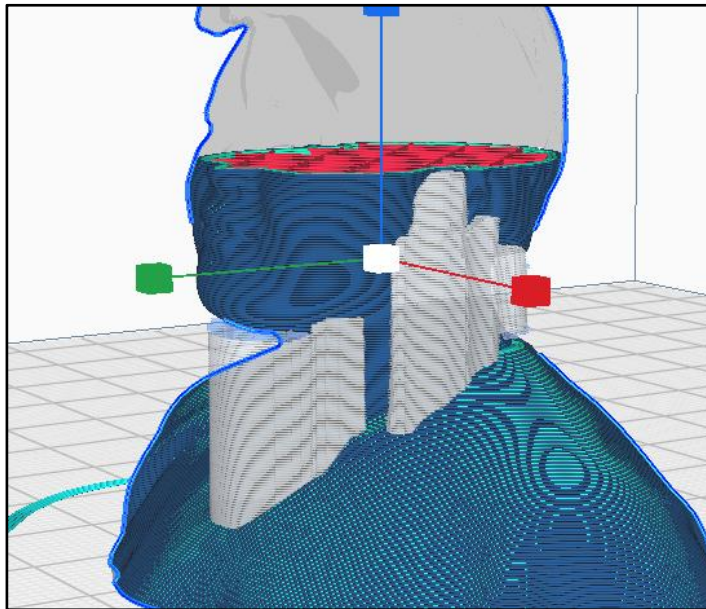

### How to tell whether an object needs supports?

The shortest answer is: it comes with experience. With your first prints, stick to the default cura values ("Supports placement-Everywhere"). Once you feel comfortable with printing complex shapes using default support settings, try playing around with the Overhang threshold option in the settings.

**You have two options to choose from when selecting support generation:**

- **Support on Build Plate Only** - generates supports only in the space between the object and the print bed.
- **Everywhere** - generates supports everywhere.

The default support pattern usually works correctly, but **if you need to modify the places where the supports will be generated**, click the "support blocker" on the left side of the interface, and click the model, it will generate a small cube. Then adjust the size of this cube as your support. Once you finish, click "" per model setting" on the left side of the interface and select "print as support".

- **The Overhang Threshold allows you to set the minimum angle for printing the support material.** Setting the value to zero will enable an automatic calculation. Try generating supports with different angle settings to see which value works best for your object.
- **Wherever the supports touch the model, they are usually associated with a lower surface quality.** Try to reduce or even avoid the need for supports by rotating or shifting the model accordingly.

### 6.3.3. Speed vs Print Quality

A small object can be printed in a few minutes but printing bigger models can take a lot of time -sometimes even dozens of hours.

**The printing speed is affected by several factors.** Primarily, it depends on the layer height. This can be set in Mingda Cura in the Print Settings drop-down menu in the upper right corner. 0.2mm is pre-set, but you can speed up the printing by choosing 0.30mm. Models printed like this will have less detail and more visible layers.

If you care more about quality than speed, choose 0.12mm. The appearance of the models will improve, but at the cost of a significant decrease in printing speed.

**Some profiles may have two variants.**

- **Quality** - slower perimeter and infill printing, improves the surface quality
- **Speed** - faster perimeter and infill printing, without too much impact on the surface quality

The speed can be adjusted during printing, via the Percentage-Speed. Then tap increase or decrease to adjust the speed up or down. Observe the effect of the speed change on the print quality and choose the settings that suit you best. Remember that **this setting does not affect the acceleration of the printer**, so the printing time will not be shortened proportionally to the speed setting change.



### 6.3.4. Infill

Another parameter that affects the properties of the printed object is Infill. It affects the printing speed, strength and appearance of the object. Objects printed with the FFF/FDM method usually do not have 100% density. Instead, they contain a certain geometric structure inside. It can take various forms, from simple square grids or hexagons to more complex patterns. The purpose of the infill is to stiffen the object from the inside. Most models are printed with 10-15% infill, but if you need a really solid structure, you can choose a higher density.

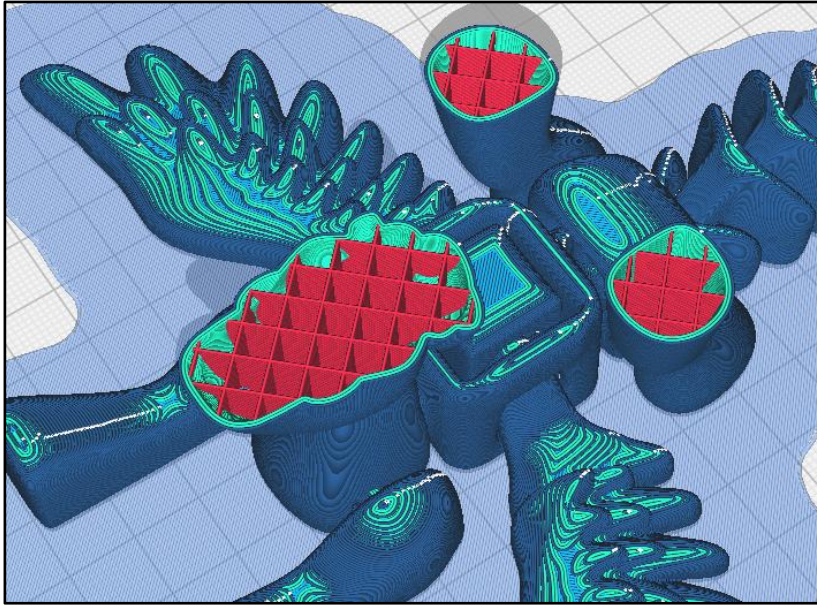

### 6.3.5. Brim

The brim serves to **increase adhesion to the bed**, reducing the risk of warping. A wider first layer is printed around the model. This makes sense especially if the model only touches the bed in a small area. This function can be enabled in Mingda Cura by checking the "Build plate adhesion-type" in the menu in the right column. After the printing is finished, **the brim can usually be removed easily by hand**, or you can use a knife or scalpel.

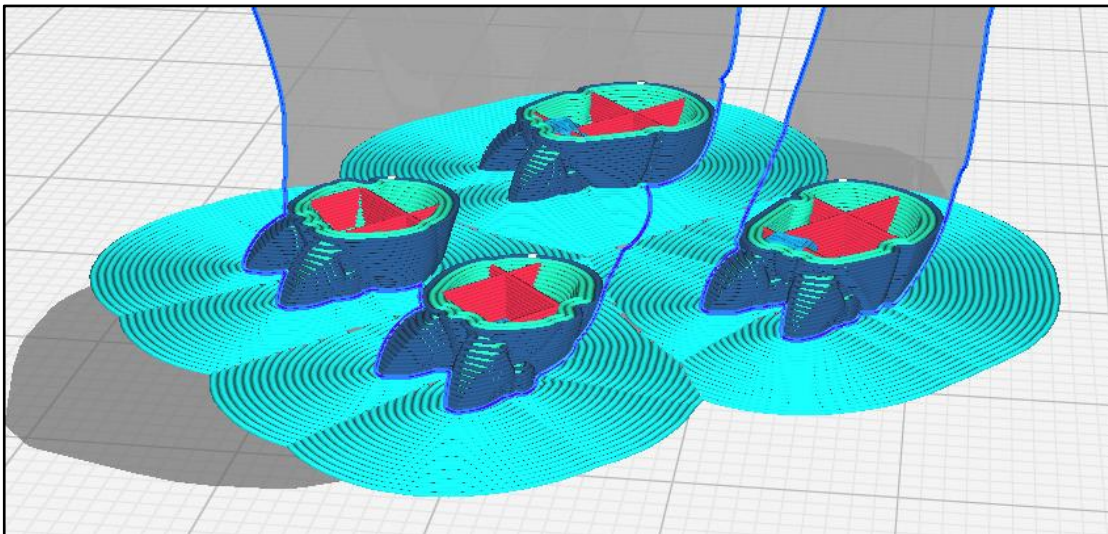

### 6.3.6. Printing Objects Larger than the Print Volume

The Magician X2 printer has a print volume of 230 × 230 × 260 mm. If this is not enough for your project, you can use Mingda Cura's built-in tools to find a solution.



Don't let the size of the print bed be a limitation

Of course, you can also resize the imported model to fit the bed. The Scale tool on the left side of the interface is there to help you with that. If you want to print an object which is too large in its original size for the print bed, you can cut it into several smaller parts. Check the link: <https://all3dp.com/2/cura-split-model-tutorial/>

### 6.3.7. Slicing and Exporting

**One of the most important phases of the slicing process is the final check of the sliced object in the Preview.** Using the slider on the right, you can review all the print layers of the object one by one. This will help you identify problematic spots - for example, if the bottom of the object doesn't stick well to the bed or if some of the parts are missing supports and are "hanging in the air" .

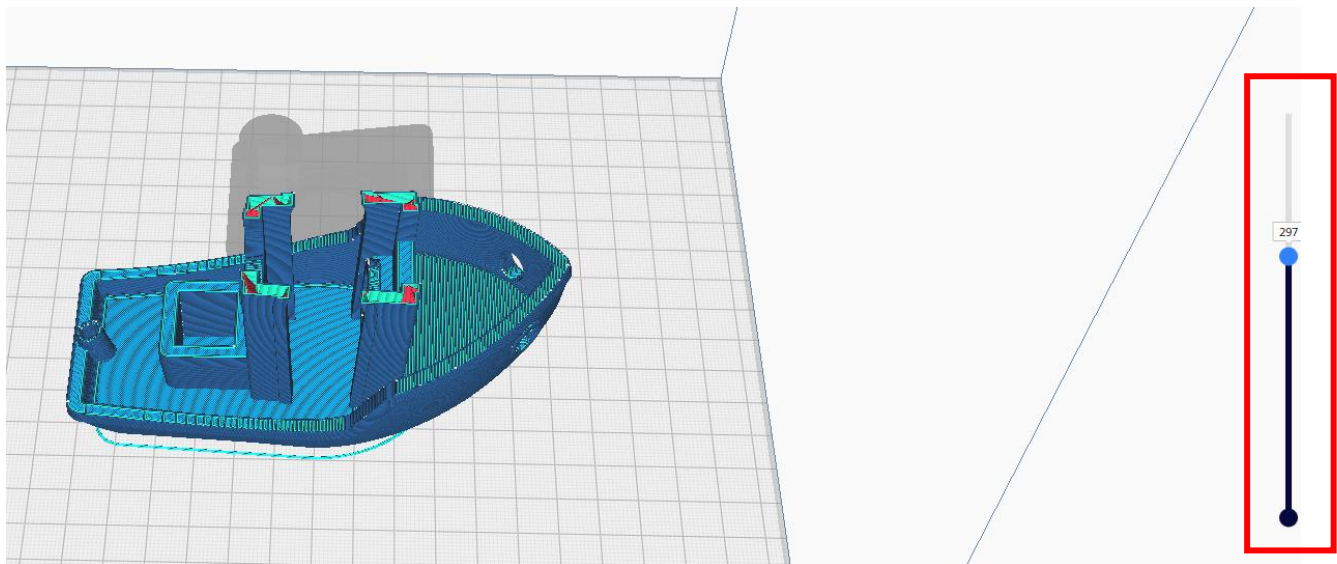

Before you export the model as G-code and upload it to the USB drive, always check it in the Preview first. It's the best way to avoid mistakes during printing.

## 7. Regular Maintenance

The Mingda Magician X2 was designed from the beginning as a true print "workhorse". Despite its high reliability, it is still a device with mechanical components that require more or less regular maintenance. Follow the instructions below to keep your printer in perfect condition for as long as possible.

### 7.1. Keeping the Printer Clean

After several hours of printing, various kinds of debris may start to accumulate around the printer parts or under the heatbed - pieces of filament, dust, scraps, broken supports, etc. **Always make sure that the parts of the printer are clean.** You can use a brush, a small broom or a vacuum to remove debris.

### 7.2. Bearings

Every couple hundred hours, the smooth rods should be cleaned with a paper towel. Apply a little bit of the lubricant on the smooth rods and move the axis back and forth a couple of times. This cleans the dirt and increases longevity.

If you feel the axis is not running smoothly anymore, bearings can be taken out and greased on the inside (they need to be removed from the axis because the plastic lip will prevent most of the grease from getting inside).

### 7.3. Fans

If the fan suddenly slows down (Sounds abnormal), for example due to a piece of filament stuck in it. In such a case, check and remove any dirt from the relevant fan. Both fans should be checked and cleaned after every few hundred hours of printing. Dust can be removed with compressed air in a spray can, small plastic threads can be removed with tweezers. **Do not blow compressed air on the running fan.**

### 7.4. Extruder Feeding Gear

The feeding gear in the extruder does not need any lubricant. Over time, a filament powder deposit may form in the grooves, causing poor extrusion of filament. Remove the debris using compressed air in a spray, small plastic threads can be removed with tweezers. Use the access opening on the front of the extruder.

### 7.5. Electronics

It is a good practice to check and optionally reconnect the electrical connectors on the X/Z axis ribbon cable and motor cable in the extruder every 600-800 hours of printing.

## 7.6. Extruder is Clogged or Jammed

Clogged extruders can cause issues when printing or when loading a new filament. On the top of the extruder, there is a screw directly next to the filament insertion point. You can adjust the idler pressure by loosening or tightening these screws. By removing the screw knob, you can check the filament track for any blockages. When you open the extruder handle, you can easily clean the feed gear of all filament remnants. We recommend regularly cleaning the gear.

## 7.7. Cleaning the Nozzle



Do not touch the nozzle during this procedure - it is hot and there is a risk of burning yourself! To better access the extruder during cleaning, raise the extruder to the top of the Z-axis in the Menu - Move- Z+/Z-

### 7.7.1. The filament does not come out of the nozzle.

**If the filament does not pass through the extruder and no plastic is being extruded, check the following:**

- Open the screw knob on the front side of the extruder to see if the filament strand reached the extruder gear and continues down into the nozzle
- See if the temperatures are set correctly (190 °C for PLA, 230 °C for PETG, etc.)
- Check if the fan on the side of the extruder is spinning

If the filament strand is not visible (does not reach the extruder wheel), the problem is likely near the filament entry point or the filament sensor. Inspect the path of the filament and see if the filament sensor isn't stuck.

### 7.7.2. The filament does not come out of the nozzle or only a small amount comes out.

**The filament does not come out of the nozzle or only a small amount comes out**

1. Heat the nozzle to the appropriate temperature for the filament material you are printing with or slightly above. First, feed the filament, then insert an acupuncture needle or thin wire (0.3-0.35 mm) into the nozzle from the bottom to a depth of about 1-2 cm. Use protective gloves in case material suddenly starts to come out of the nozzle.
2. Select the Load Filament option from the menu and check that the nozzle is actually extruding the filament.
3. Again insert the wire or acupuncture needle into the nozzle and repeat the whole procedure several times. If the filament is being extruded correctly, the nozzle is clean.



## 7.8. Troubleshooting Faulty Sensor Readings and Removing Errors

If you encounter problems with the filament sensor, such as incorrect (or random) readings, make sure that everything in the extruder is correctly wired and that there is no debris in the filament path inside the extruder. If this doesn't help, please contact our tech support.

## 7.9. Printer Does Not Recognize the Inserted USB Drive

If the printer does not recognize the SD card or USB drive, try restarting the printer first. The most probable cause is an incompatible file system (e.g. exFAT). Use a smaller USB drive (4-16GB) formatted with the FAT32 file system. Once the USB drive is inserted, one of two situations may occur:

### **Cannot access the Print menu after inserting the USB drive**

1. Restart the printer first
2. Formatted the SD card or USB to FAT32 with a single partition
3. Try using a different SD card or USB drive

**If you have tried multiple USB or SD card and none of them can be read, there may be a problem with the mainboard. Contact our technical support. SD card or USB drive is recognized but no files are visible in the file browser:**

1. Make sure you are using compatible G-code
2. Make sure the file is correctly written to the drive  
(in Windows use the "Safely remove" function before ejecting the drive)
3. Try a different SD card or USB drive and a different G-code file
4. Try renaming the file to something simpler, e.g. model.gcode

# MINGDA

© 2023 MINGDA Technology Co., Ltd. All rights reserved.

Shenzhen MINGDA Technology Co.,LTD

Email: [info@3dmingda.com](mailto:info@3dmingda.com)

[www.3dmingda.cc](http://www.3dmingda.cc)



Support request



Youtube Channel



Facebook Page



Mingda Official