



USER MANUAL

M225 Drive System

Thank you for using BAFANG products.

When using or modifying parameters, please make sure to comply with the local laws and regulations.

Original instruction manual

Read carefully before use. Keep for later reference.

BF-UM-S-M225-2-EN-PRINT, November 2021

SYMBOL INSTRUCTION

If you see the following symbols there is always a possibility of danger.

The warning symbols are as follows:

 **Note:** This symbol indicates information about how to use the product and highlights specific parts of the User's Guide that are important.

 **Caution:** This symbol warns against misuse of the products that can lead to it being damaged or polluting the environment.

 **Danger:** This symbol indicates possible health and safety hazards that may arise, if certain measures are not taken into consideration.

 **User Manual:** Please read the manual before using the pedelec. If you are not sure about any of the topics in the manual, please contact your retailer for assistance.

CONTENT

1 Guide	2	8 Display	16
1.1 Quick Start.....	2	8.1 Important Notice.....	16
1.2 Before Each Ride.....	2	8.2 Introduction of Display.....	16
2 Important Notice	3	8.3 Product Description	16
2.1 For Your Safety.....	3	8.4 Display Information.....	17
2.2 Installation and Maintenance.....	3	8.5 Key Definition.....	17
2.3 Laws and Regulations.....	4	8.6 Normal Operation	18
3 Vehicle Transport	4	8.6.1 Switching the System ON/OFF	18
4 Environmental Tips and Handling Requirements	5	8.6.2 Selection of Support Levels.....	18
5 Guaranty	5	8.6.3 Selection Mode	18
6 Installation	6	8.6.4 Headlights / backlighting.....	18
6.1 Summary of the Components.....	6	8.6.5 Walk Assistance.....	19
6.2 Drive Unit Installation.....	7	8.6.6 SERVICE.....	19
6.3 Display Installation	10	8.7 Settings	20
6.4 Battery Installation.....	11	8.7.1 "Display Setting".....	20
6.5 Speed Sensor Installation.....	12	8.7.2 "Information"	24
6.6 E-Brake Lever and Throttle Installation	12	8.8 Error Code Definition.....	26
6.7 Headlight and Taillight Installation	13	9 Battery	29
7 Drive Unit	14	9.1 Introductions.....	29
7.1 Introduction.....	14	9.2 Operation.....	31
7.2 Specifications.....	14	9.3 Specifications	35
7.3 Maintenance	15		

1 GUIDE

1.1 Quick Start

 This section provides important information and instructions that will allow you to use your pedelec in a safe manner. First, please read the safety instructions to find out about the legal regulations that apply to you.

 **Perform all safety checks in accordance with the "Before each trip" section.**

- Fully charge the battery.
- Make sure the battery is securely locked.
- Please make sure your pedelec is adapted to your needs.
- To start the system, press and hold the "⏻" button on the control panel for 3 seconds.
- Select the support level.

 **The pedelec is now ready for operation.**

 Always press the brakes of your pedelec before placing your foot on the pedal! The motor starts assisting as soon as you start pedaling. Without the correct procedure, the pedelec can suddenly start, which can lead to injuries.

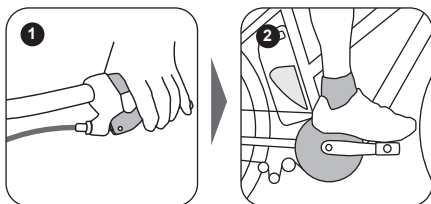

 Practice using the pedelec in a quiet and safe environment. It is important to learn the characteristics of the pedelec before you drive on public roads.

 Please also take note of additional user manuals that you received when you bought your pedelec.

1.2 Before Each Ride

 Do not try to ride the bike if you think that your pedelec might be defected. Before the first ride, please make sure that the retailer has checked the complete bike before handing it over to you. It is also recommended to have all components of the bike checked regularly, especially if you ride on a regular basis. If you mistreat the pedelec, it can lead to accidents and injuries.

 Please check the pedelec after an accident or if your pedelec has fallen over.

2 IMPORTANT NOTICE

 Be sure to follow the instructions in the manual when using this product.

- If you are lending your pedelec to third parties, please give them the instruction manual along with the pedelec.
- Read the instruction manual carefully and keep it in a safe place, for future reference.

2.1 For Your Safety

- This product is not suitable for people with physical, sensory or mental disabilities, or children and adults without the necessary experience. Otherwise, the pedelec must be used under the supervision of the guardian responsible for their safety.
- The use of the pedelec is not suitable for children under 14 years of age.
- Before driving, make sure you are familiar with the original features of the pedelec.
- For safety reasons, do not try to focus too much on the display of the pedelec whilst driving. This can be distracting, which can lead to sudden accidents.
- Regularly check the battery charger for damage. Inspect cables, plugs and housings. If damage is detected, do not use the charger until it has been checked or repaired.
- Do not change the system without authorization, otherwise errors may occur which may result in an accident. Also, this can void the warranty.
- This product is waterproof for all types of weather. However, it is strongly recommended not to intentionally submerge the product in water or clean it with a steam jet.

2.2 Installation and Maintenance

 Make sure that the charger is disconnected from the mains before removing from the pedelec. Remove the battery before working on/maintaining the pedelec. Otherwise, it can lead to serious injuries and electric shocks.

 After a fall or accident, the electrical components may be damaged. If you notice damage to the battery, remove the battery immediately, place it in a safe location and contact your retailer.

 Do not replace components, remove or open modules unless you are performing operations described in this Manual. If you have any questions about your system or components, please contact your authorized retailer first. If the battery charger, cable or components are defected or worn out, the components must be replaced. Please use the manufacturer's original spare parts. Otherwise, the warranty will be void. The use of non-original or incorrect spare parts may cause the pedelec to malfunction. If the product has a defect, please contact your retailer for a replacement part. The authorized retailer can only use the original spare parts from Bafang for maintenance.

 Do not use no high-pressure water jet or submerge in water to clean pedelec. This can cause water to enter into the electrical components or the drive system and short circuit or damage the system.

 Dispose of the pedelec/battery according to the rules and regulations of your country's origin. For more information please contact an authorized recycling center or your retailer.

 Depending on riding conditions and the frequency of use, the service interval may vary. Please keep in mind that the chain should be

regularly treated with a suitable chain spray. Under no circumstances should an alkaline or acidic detergent be used to remove rust. When this detergent is used, it can damage the chain or other parts of the pedelec resulting in injury or damage.

- ! Only trained personnel can maintain or repair the product.
- Remove the battery during transport and store the battery in a safe and dry place.
- Use this product carefully to allow a long service life.
- It is advised to write down the battery key number and keep it safe, in case of damage or loss.
- Natural wear and aging of the system is common after a period of time.

2.3 Laws and Regulations

! Please observe the relevant road traffic rules and regulations of your country.

Before driving on public roads, please read the applicable countries regulations carefully. The use of pedelecs on public roads must comply with local regulations. Contact your local road traffic authority for more information.

! Incorrect operation of the drive system, battery, charger or drive components can result in injuries. In this case, the manufacturer may refuse liability for the damage caused. Unauthorized changes to the pedelec system can lead to criminal offences, such as a change of the speed limit.

! Please note the following information:

- Please ensure that the light sensor is in working order, before setting off.
- Please ensure that the braking system is operational before setting off.

3 VEHICLE TRANSPORT

! Remove the battery during transport and store the battery in a safe and dry place.

! Do not transport a battery without the correct procedure. Batteries are subject to hazard group 9 and are subject to a separate transport regulation. Please contact an authorized retailer or freight service provider. The battery can be damaged, burned or even explode if handled incorrectly.

! When transporting the pedelec by train, the relevant laws and regulations must be complied with. Before using public transport, please find out which means of transport are suitable for transporting the pedelec. It is recommended to remove the battery from the pedelec before transport.

! When transporting your pedelec, first Remove the battery and keep it in a safe place so it does not move whilst driving. When transporting your pedelec please be sure to use a pedelec carrier.

4 ENVIRONMENTAL TIPS AND HANDLING REQUIREMENTS

General cleaning and maintenance: take environmental aspects into consideration when maintaining and cleaning the pedelec. The product and detergents should be biodegradable. Use these products at any time just, please make sure that no cleaning agent does not get into the sewage.

The battery

Battery used in the pedelec is subject to the Battery Ordinance and may only be disposed of in accordance with the applicable regulations.

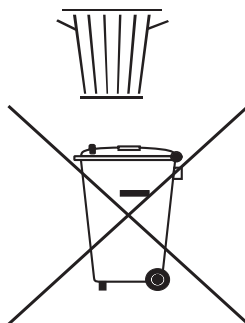
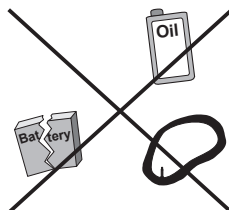

5 GUARANTY

i All warranty and guarantee conditions are subject to applicable laws and regulations from your brand.

The condition for warranty and guarantee claims is that the instructions for the system are followed carefully.

Liability for material defects does not include normal aging or wear and tear.

Warranty Period:

Under compliance with local law and reasonable use, the warranty period ends 12 months after the date of selling.

Warranty and warranty exclusions:

- Modification, manipulation or improper repair of the product.
- Improper use of the product.
- Damage caused by inconvenience, misuse, negligence, incorrect installation, improper repair, incorrect maintenance or improper use.
- Modifications of the surface structure.
- Damage caused by improper transport or storage caused by the buyer.
- Damage caused by force majeure.
- Removal or alterations of serial number, plates or product markings.

6 INSTALLATION

! The bicycle adapted to the M225 drive system needs to meet the following requirements:

- The upper area of downtube shall have a motion range of 390mm in length and 145mm in height for battery installation.
- Cable brake is adopted for the sake of modification of e-brake lever.
- The length of bottom bracket matches the length of motor shaft.
- The CL value of chainring shall be compatible to that of the original bicycle.

6.1 Summary of the Components

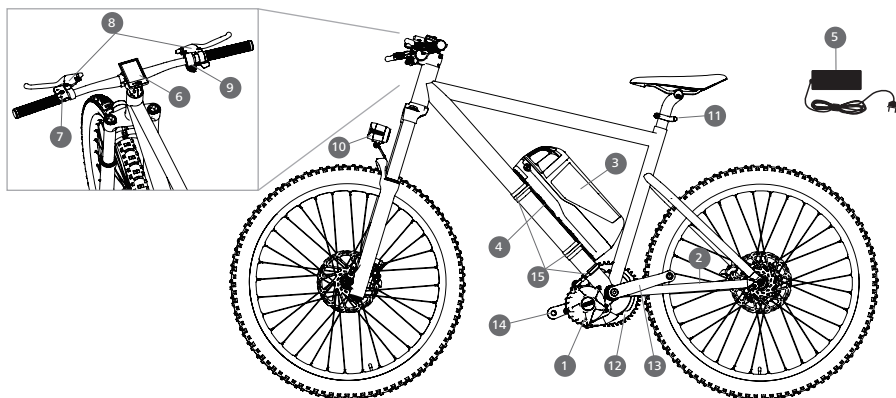

- | | | | |
|------------------|-------------------|------------------|-----------------------|
| 1. Drive Unit | 2. Speed Sensor | 3. Battery | 4. Battery Slide Rail |
| 5. 4A Charger | 6. Display | 7. Control Panel | 8. e-Brake Lever |
| 9. Throttle | 10. Headlight | 11. Taillight | 12. Chainring |
| 13. Crank (left) | 14. Crank (right) | 15. Hoop | |

! You can scan the QR code to watch the installation video of DIY system.







6.2 Drive Unit Installation

6.2.1 List of Tools to be Used



An impact wrench cannot be used.

Use of the Tools	Tools
To fasten M5 screws onto the chainset.	 Internal star screw wrench
To fasten M6 screws onto the support and the drive unit.	 Internal star screw wrench
To fasten M8 screws on the crank.	 Internal hex wrench
To fasten screws on the hose clamp.	 Cross screwdriver
Locking ring M33-A	Special tool
Locking ring M33-PH1(B)	Special tool

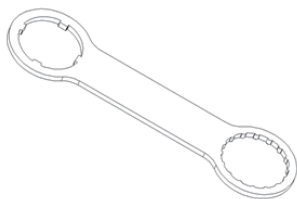

Special tool

6.2.2 Motor Installation

NOTE: Before installing the motor, please remove the chainset and crank from the original bike.

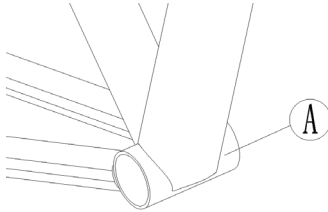

A BB (bottom bracket)

1. Insert the motor into the BB.

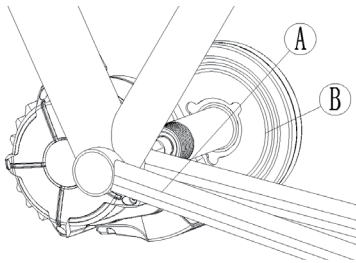

A Frame
B Motor

2. Put the BB support on the middle shaft of the motor, and then with a Internal star screw wrench to prelock a M6 star screw on the motor (Do not tighten first).

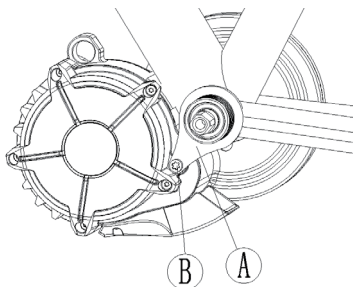

A BB support
B Internal star screw

3. With the special tool to prelock a locking ring (M33-A) on the motor (Do not tighten first).

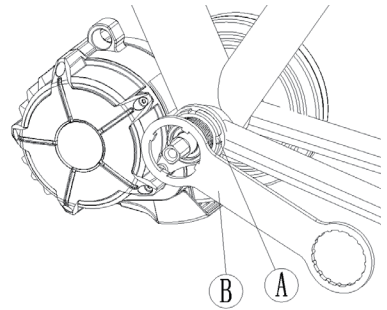

A Locking ring M33-A
B Special tool

4. Put the rubber washer on the frame, and then set the hoop set on the motor (Note: rubber washer and hoop set should be mounted perpendicular to the down tube, the hoop head is to the right of the frame).

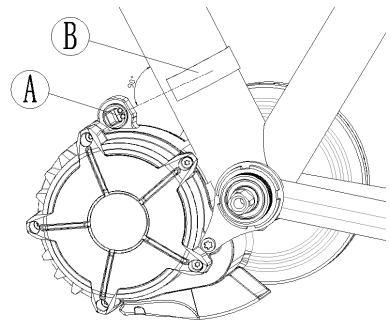

A Hoop set
B Rubber washer

- Tighten the hose clamp on the frame with a cross screwdriver (Note: the hoop should be tied on the rubber washer, and the hoop is perpendicular to the down tube. The locking torque is 3-4Nm), and then tighten the unlocked parts of step 2 (the locking torque is 9-10Nm) and step 3 (the locking torque is 50-60Nm).

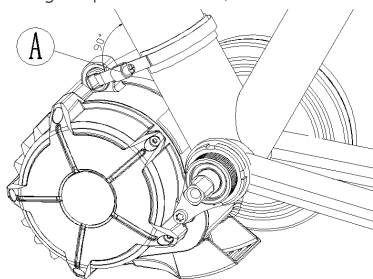

A Hose clamp

- With the special tool tighten the locking ring M33-PH1(B) onto the motor (the locking torque is 25-30Nm).

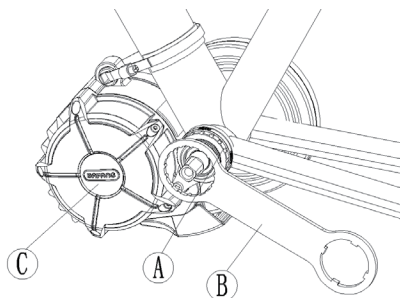

A Locking ring M33-PH1(B)
B Special tool

- Put the chainset on the output end of the motor, and then with five M5 star screws tighten it on the motor (the locking torque is 25-30Nm).

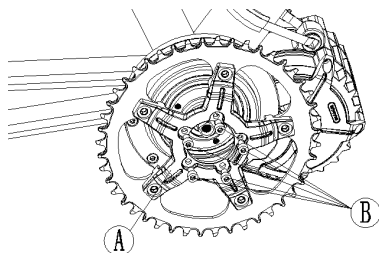

A Chainset
B M5 Internal star screw

- Mount the right crank on the right shaft and with an M8 inner hex screw tighten it, the locking torque is 35-40Nm, tighten the left crank in the same way.

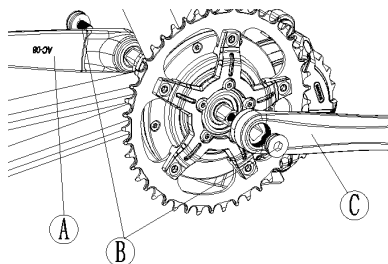

A Left crank
B M8 Internal hex screw
C Right crank

- Connect the EB-BUS cable

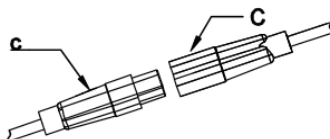

C Female connector of EB-BUS
C Male connector EB-BUS from drive unit

6.3 Display Installation

1. Open the clamps of display and insert the rubber rings on the inside of the clamps.

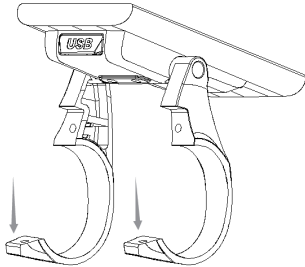

2. Now place the display on to the handlebar in the correct position. Now with 2 X M3*12 screws tighten the display into position. Torque requirement: 1N.m.

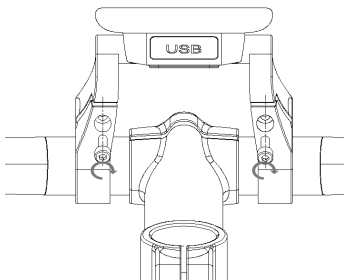
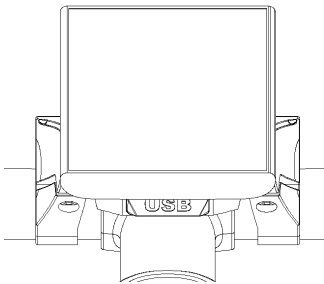

3. Open the clamp on the control panel and place it in the correct position, Using 1 X M3*10 screw tighten the control panel onto the handlebar. Torque requirement: 1N.m.

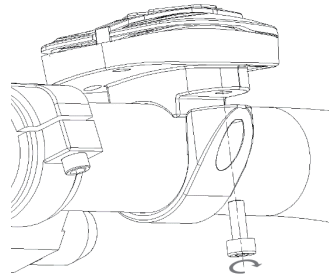
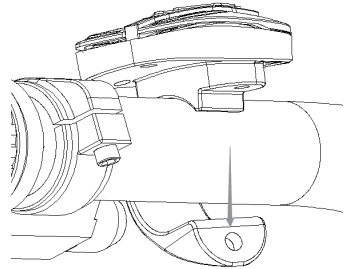

4. Connect the display to the EB-BUS cable.

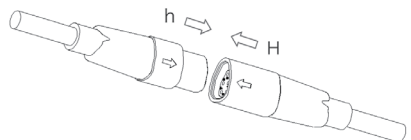

6.4 Battery Installation

i For correct insertion, the battery must be connected, ensuring all pins are correctly connected to the battery holder. When pushing the battery into position. Make sure that the battery has clicked into the locking mechanism before you set off.

1. Fasten the slide rail with 2pcs hose clamp onto the down tube. Please notes it needs fit rubber for hose clamp before assembly.

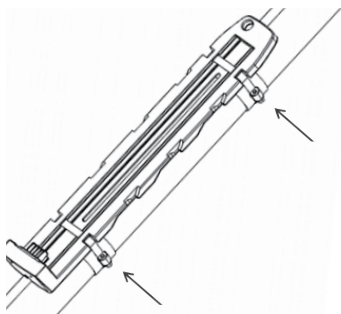

2. First rotate the lock to the open position, then insert the battery into the slide rail, and push the battery into the down bracket. Finally rotate the key and lock the battery.

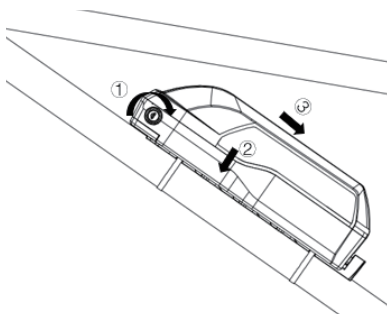

NOTE: The key can only be removed after the battery is locked, otherwise it can not be removed.

3. Connect the power cable.

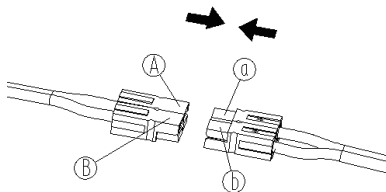

- A** Battery + (red)
- a** Drive unit + (red)
- B** Battery - (black)
- b** Drive unit - (black)

4. Connect the battery communication cable.

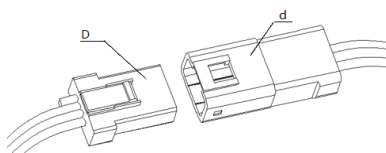

- D** Male connector of battery
- d** Female connector from driver unit

6.5 Speed Sensor Installation

1. First insert the speed sensor (A) into the support (B) and tighten the screw (C) with a screwdriver.

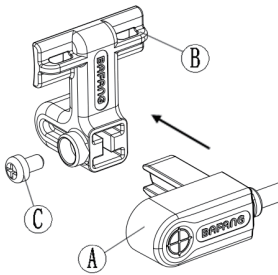

- A Speed sensor
- B Support
- C Screw

2. First with cable ties fasten the speed sensor onto the chain stay, and then tighten mounting screw on magnet to the spokes with cross screwdriver. Tightening torque is 1.5–2Nm. Please make sure the gap between the speed sensor and the magnet is 5 mm.

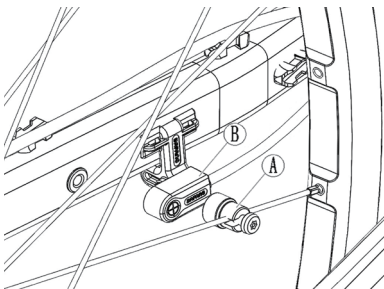

- A Magnet
- B Speed Sensor

3. Connect the speed sensor to the drive unit.

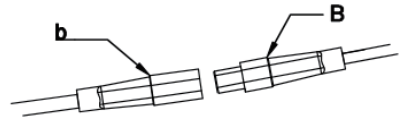

- B Male connector from speed sensor
- b Female connector from the drive unit

6.6 E-Brake Lever and Throttle Installation

1. Install the left e-brake lever and the grip on the handlebar.

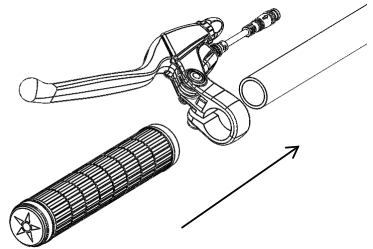

2. Now with M5 screw tighten the e-brake lever into position.

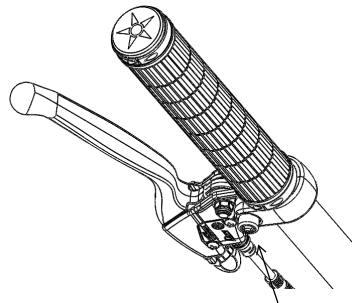

3. Install the throttle, the right e-brake lever, and the grip on the handlebar.

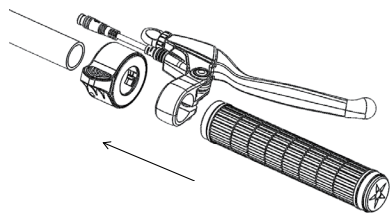

4. Now with M3 and M5 screws tighten the throttle and the e-brake lever into position.

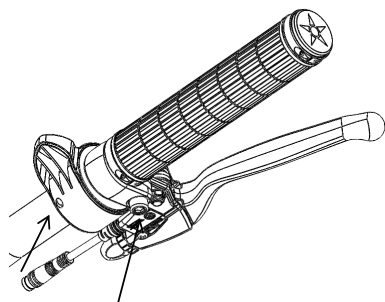

5. Connect the e-brake levers and the throttle to the EB-BUS cable.

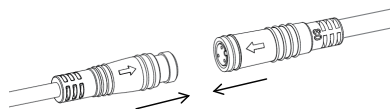

6.7 Headlight and Taillight Installation

1. Tighten the headlight and taillight into position.

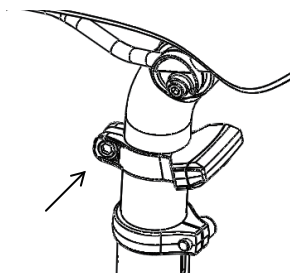
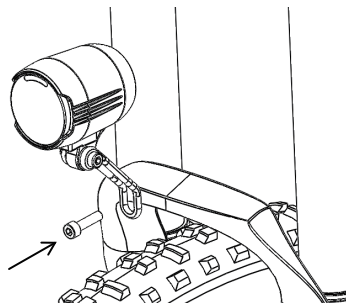

2. Then connect the headlight and taillight to the EB-BUS cable.

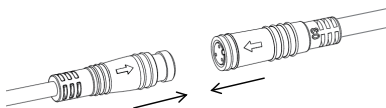

7 DRIVE UNIT

7.1 Introduction



- **Product Model**

M225 (MM G341.250.C)

- **Scope**

i Bafang M225 drive systems can only be used on vehicles intended for off-road use and designed to travel on unpaved surfaces. Please make sure to comply with local laws and regulations.

- **Identification**

There are the unique identification of the product on the housing, as shown in figure:

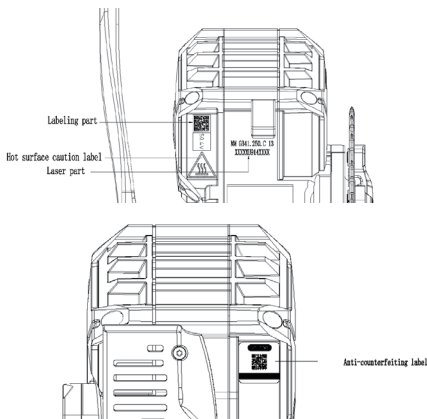

Note: Contents in Label part are important information of this product. Please keep them properly for updating of software or providing after-sales service.

The specific parameters are subject to the real product.

7.2 Specifications

Motor model: M225 (MM G341.250.C)

Rated power (W)	250
-----------------	-----

Noise (dB)	≤55
------------	-----

Waterproof	IPX5
------------	------

Certification	ROHS / EN14766 / EN14764 / UL / E-Mark
---------------	--

Outdoor Temperatures	-20°C ~ 45°C
----------------------	--------------

7.2.1 Outline and Geometric Size

M225 (MM G341.250.C)

Chain line(CL): 59.6mm BB length: 68mm

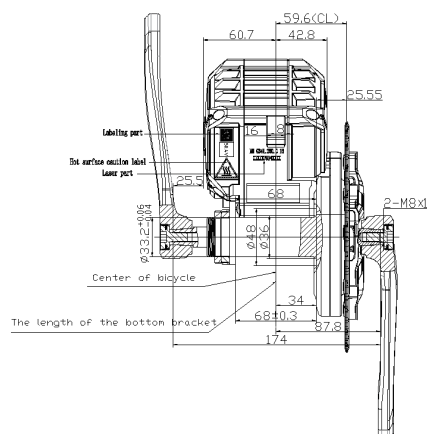
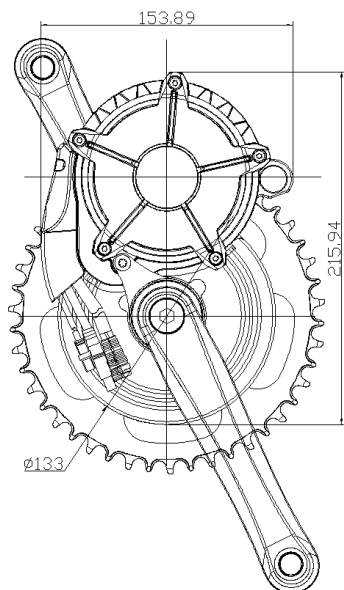

7.2.2 Surface

Shockproof black coating

7.2.3 Cautions

- Storage room humidity: 15-95%RH
- The pedelec should be stored in a ventilated dry room. Avoid storing the pedelec near strong magnetic objects.
- Should not be used for a long time overload;
- Should avoid wading to use.
- The motor runs at the rated power for 2 minutes and then stops working for 8 minutes. According to this working, the motor can be achieved the heat balance.

! The function of the product is impaired by the presence of any major caustic gas, any medium that affects the product's electrical insulation properties or any high-intensity magnetic field.

7.3 Maintenance

- Maintenance must be carried out by authorized personnel with the correct equipment.
- Do not disassemble the motor.
- Do not use thinners or other solvents to clean the components. Such substances can damage the surfaces.
- Avoid water submerging, to keep the components protected.
- Avoid using high-pressure cleaning jets.
- For prolonged storage, turn off the battery and avoid storing near heat sources.

8 DISPLAY

8.1 Important Notice

- If the error information from the display cannot be corrected according to the instructions, please contact your retailer.
- The product is designed to be waterproof. It is highly recommended to avoid submerging the display under water.
- Do not clean the display with a steam jet, high-pressure cleaner or water hose.
- Please use this product with care.
- Do not use thinners or other solvents to clean the display. Such substances can damage the surfaces.
- Warranty is not included due to wear and normal use and aging.

8.2 Introduction of Display

- Model: DP C181.CAN BUS
- The housing material is PC and high strength material:



- The label marking is as follows:



- **Note:** Please keep the QR code label attached to the display cable. The information from the Label is used for a later possible software update.

8.3 Product Description

8.3.1 Specifications

- Operating temperature: -20 °C~45 °C
- Storage temperature: -20 °C~50 °C
- Waterproof: IPX5
- Bearing humidity: 30%-70% RH

8.3.2 Functions Overview



- Speed display (including top speed and average speed, switching between km and miles).
- Battery capacity indicator.
- Automatic sensors explanation of the lighting system.
- Brightness setting for backlight.
- Indication of assistance support.
- Motor output power and output current indicator.
- Mileage show (including single-trip distance, total distance and remaining distance).

- Walk assistance.
- Energy consumption indicator CALORIES (Note: If the display has this function).
- Display for the remaining distance. (Depends on your riding style)
- Setting password.
- Bluetooth function. (the display can connect to the mobile through Bafang Go APP)
- USB charge port (5V 500mA)
- Parameter setting (The default support level, speed limit, wheel size)

- Maintenance indicator.
- Bluetooth indicator.
- Service: Please see the service section.
- Support level/ Walking assistance 
- Time
- Power indicator in watts / amperes.
- Support level indicator.
- Default Mode: ECO/SPORT
- Speed Graphics.
- Data: Display data, which corresponds to the current mode.
- Trip: Daily kilometers (TRIP) - Total kilometers (ODO) - Top speed (MAX) - Average speed (AVG) - Range (RANGE) - Energy Consumption (CALORIES(only with torque sensor fitted)) - Travel time (TIME).
- Display of battery capacity in real time.

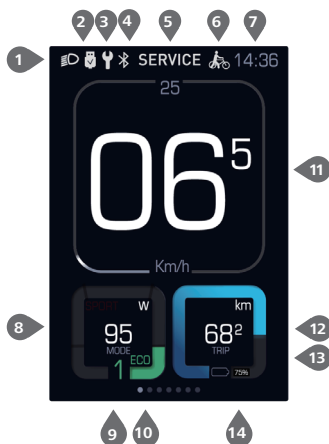
8.4 Display Information



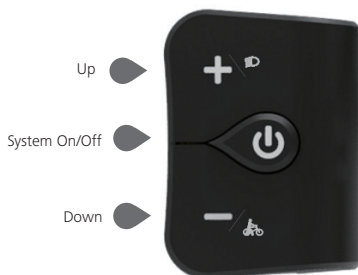

- The display shows  this symbol, if the light is on.
- USB charging indicator displays the icon , if an external USB device is connected to the display.

8.5 Key Definition





8.6 Normal Operation



8.6.1 Switching the System ON/OFF

Press and hold  (>2S) on the display to turn on the system. Press and hold  (>2S) again to turn off the system.

If the "automatic shutdown time" is set to 5 minutes (it can be set with the "Auto Off" function, See **"Auto Off"**), the display will automatically be turned off within the desired time when it is not in operation. If the password function is enabled, you must enter the correct password to use the system.

When turn on the system, you can see the disclaimer, and you can press  or  to select the consent or not prompt at next time and press  to confirm.

8.6.2 Selection of Support Levels

When the display is turned on, press the  or  (<0.5S) button to switch to the support level, the lowest level is 0, the highest level is 5. When the system is switched on, the support level starts in level 1. There is no support at level 0.



8.6.3 Selection Mode

Briefly press the  (0.5s) button to see the different trip modes.

Trip: daily kilometers (TRIP) - total kilometers (ODO) - Maximum speed (MAX) - Average speed (AVG) - Range (RANGE) - Energy consumption (CALORIES (only with torque sensor fitted)) - Travel time (TIME).



8.6.4 Headlights / backlighting





Hold the  (>2S) button to activate the headlight and taillights.

Hold the  (>2S) button again to turn off the headlight. The brightness of the backlight can be set in the display settings **"Brightness"**. If the display / Pedelec is switched on in a dark environment, the display backlight/headlight will automatically be switched on. If the display backlight/headlight has been manually switched off, the automatic sensor function is deactivated. You can only turn on the light manually, after switching on the system again.



8.6.5 Walk Assistance

The Walk assistance can only be activated with a standing pedelec.

Activation: Press the  button until this symbol  appears. Next hold down the button whilst the  symbol is displayed. Now the Walk assistance will activate. The symbol  will flash and the pedelec moves approx. 6 km/h. After releasing the  button, the motor stops automatically and switches back to level 0.



8.6.6 SERVICE

The display shows "Service" as soon as a certain number of kilometers or battery charges has been reached. With a mileage of more than 5000 km (or 100 charge cycles), the "Service" function is displayed on the display. Every 5000 km the display "SERVICE" is displayed every time. This function can be set in the display settings.

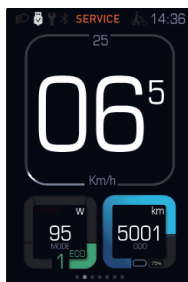

8.7 Setting

After the display is turned on, press and hold the **+** and **-** (>1S) button, to access the "SETTING" menu. By pressing the **+** or **-** (<0.5S) button, you can select: Display Setting, Information or EXIT. Then press the **⏻** (<0.5S) button to confirm your selected option.

Or select "EXIT" and press the **⏻** (<0.5S) button to return to the main menu, or select "BACK" and the **⏻** (<0.5S) button to return to the Settings interface.

If no button is pressed within 20 seconds, the display will automatically return to the main screen and no data will be saved.

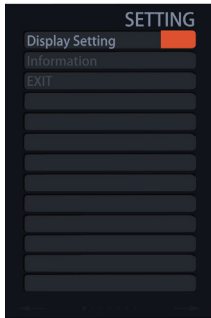

You can press and hold the **+** and **-** (>1S) button at any time, to return to the main screen.

8.7.1 "Display Setting"

Press the **+** or **-** (<0.5S) button to select "Display Setting", and then briefly press the **⏻** (<0.5S) button to access the following selections.



8.7.1.1 "Unit" Selections in km/Miles

Press the **+** or **-** (<0.5S) button to highlight "Unit" in the display settings menu, and then press the **⏻** (<0.5S) button to select. Then with the **+** or **-** button choose between "Metric" (kilometer) or "Imperial" (Miles). Once you have chosen your desired selection, press the **⏻** (<0.5S) button to save and exit to the "Display Setting" interface.



8.7.1.2 "Service" Switching the notification on and off

Press the **+** or **-** (<0.5S) button to highlight "Service" in the display settings menu, and then press **⏻** (<0.5S) to select. Then with the **+** or **-** button choose between "ON" or "OFF". Once you have chosen your desired selection, press the **⏻** (<0.5S) button to save and exit to the "Display Setting" interface.

8.7.1.3 "Brightness" Display brightness

Press the **+** or **-** (<0.5S) button to highlight "Brightness" in the display settings menu. Then press **⏻** (<0.5S) to select. Then with the **+** or **-** button choose between "100%" / "75%" / "50%" / "30%" / "10%". Once you have chosen your desired selection, press the **⏻** (<0.5S) button to save and exit to the "Display Setting" interface.

8.7.1.4 "Auto Off" Set Automatic system switch off time

Press the **+** or **-** (<0.5S) button to highlight "Auto Off" in the display settings menu, and then press **⏻** (<0.5S) to select. Then with the **+** or **-** button choose between "OFF", "9"/"8"/"7"/"6"/"5"/"4"/"3"/"2"/"1". (The numbers are measured in minutes). Once you have chosen your desired selection, press the **⏻** (<0.5S) button to save and exit to the "Display Setting" interface.

8.7.1.5 "Default Mode"

Press the **+** or **-** (<0.5S) button to highlight "Default Mode" in the display settings menu, and then press **⏻** (<0.5S) to select. Then with the **+** or **-** button choose between "ECO/SPORT". Once you have chosen your desired selection, press the **⏻** (<0.5S) button to save and exit to the "Display Setting"



8.7.1.6 "Power View" Setting the power indicator

Press the **+** or **-** (<0.5S) button to highlight "Power View" in the display settings menu, and then press **⏻** (<0.5S) to select. Then with the **+** or **-** button choose between "Power" or "Current". Once you have chosen your desired selection, press the **⏻** (<0.5S) button to save and exit to the "Display Setting" interface.



8.7.1.7 "SOC View" Battery view in volt percent

Press the **+** or **-** (<0.5S) button to highlight "SOC View" in the display settings menu, and then press **⏻** (<0.5S) to select. Then with the **+** or **-** button choose between "percent" or "voltage". Once you have chosen your desired selection, press the **⏻** (<0.5S) button to save and exit to the "Display Setting"



8.7.1.8 "TRIP Reset" Reset mileage

Press the **+** or **-** (<0.5S) button to highlight "TRIP Reset" in the display settings menu, and then press **⏻** (<0.5S) to select. Then with the **+** or **-** button choose between "YES" or "NO". Once you have chosen your desired selection, press the **⏻** (<0.5S) button to save and exit to the "Display Setting".

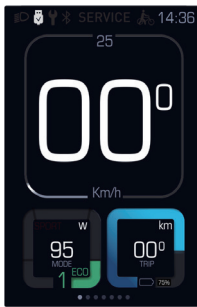

8.7.1.9 "AL Sensitivity" Automatic headlight sensitivity

Press the **+** or **-** (<0.5S) button to highlight "AL-Sensetivity" in the display settings menu, and then press **⏻** (<0.5S) to select. Then with the **+** or **-** button choose between "0"/"1"/"2"/"3"/"4"/"5"/"OFF". Once you have chosen your desired selection, press the **⏻** (<0.5S) button to save and exit to the "Display Setting".

8.7.1.10 "Password"

Press the **+** or **-** (<0.5S) button to choose "Password" in the menu. Then by briefly pressing **⏻** (<0.5S) to enter the password selection. Now again with the **+** or **-** (<0.5S) buttons highlight "Start Password" and press the **⏻** (<0.5S) button to confirm. Now again using the **+** or **-** (<0.5S) Button choose between "ON" or "OFF" and press the **⏻** (<0.5S) button to confirm.

Now you can input your 4-digit pin code. By using the **+** or **-** (<0.5S) button choose numbers between "0-9". By briefly pressing the **⏻** (<0.5S) button you can move on to the next number.

After entering your desired 4-digit code, you must re-enter the 4-digits you chose, to ensure the code is correct.

After selecting a password, the next time you turn on the system it will ask you to input your password. Press the **+** or **-** (<0.5S) button to select the numbers, Then press briefly **⏻** (<0.5S) to confirm.

After entering the wrong number three times, the system switches off. If you have forgotten the password, please contact your retailer.

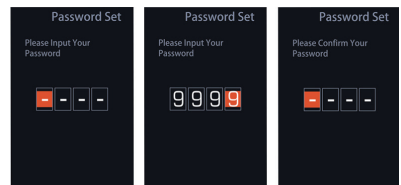

Changing the password:





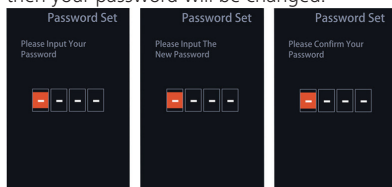

Press the **+** or **-** (<0.5S) button to choose "Password" in the menu. Then by briefly pressing **⏻** (<0.5S) to enter the password section. Now again with the **+** or **-**

(<0.5S) button highlight “Reset Password” and with the  (<0.5S) button to confirm.

By entering your old password once, followed by inputting the new password twice, then your password will be changed.







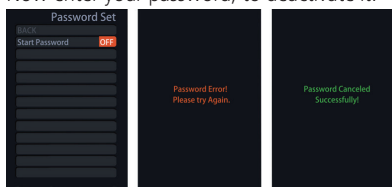

Deactivating the password:

To deactivate the password, use the  or  buttons to select “Password” and press the  (<0.5S) button to highlight your selection. Press the  or  (<0.5S) button until it shows “OFF”. Then press briefly  (<0.5S) to select.

Now enter your password, to deactivate it.







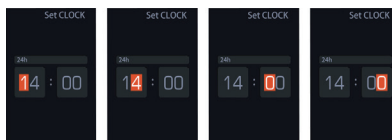

8.7.1.11 “Set Clock”







Press the  or  (<0.5S) Button to highlight “Set Clock” in the display settings menu. Then briefly press the  (<0.5S) button to confirm selection. Now press the  or  (<0.5S) button and input the correct number (time) and press the  (<0.5S) button to move to the next number. After entering the correct time, press the  (<0.5S) button to confirm and save.



8.7.1.12 “Vibration”

Press the  or  (<0.5S) Button to highlight “Vibration” in the display settings menu. Then briefly press the  (<0.5S) button to confirm selection. Then press the  or  (<0.5S) button to choose between “ON” and “OFF”. After entering the correct time, press the  (<0.5S) button to confirm and save.

8.7.1.13 “Wheel size” / “Circumference” / “Speed limit”

Press the  or  (<0.5S) Button to highlight “Wheel size” / “Circumference” / “Speed limit” in the display settings menu. Then briefly press the  (<0.5S) button to confirm selection. Then press the  or  (<0.5S) button to change the settings. Then press the  (<0.5S) button to confirm and save.

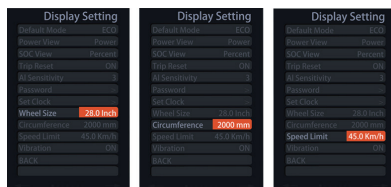

Please accept the disclaimer and comply with local regulations before changing any parameters.

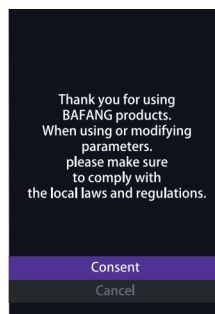

8.7.2 "Information"

Once the system is turned on, press and hold the **+** and **-** (>1S) button to access the "SETTING" menu. Now by pressing the **+** or **-** (<0.5S) button, Highlight the "Information" and press the **⏻** (<0.5S) button confirm your selection.

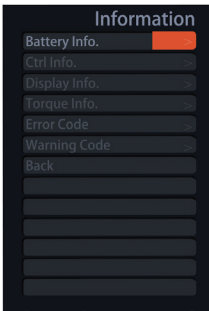

8.7.2.1 Battery Information

Press the **+** or **-** (<0.5S) button to access the "Battery Info" menu, and then press the **⏻** (<0.5S) button to select confirm. Now press the **+** or **-** (<0.5S) button and select "Back" or "Next Page". Then press the **⏻** (<0.5S) button to confirm, now you can read the battery information.



Content	Explanation
Temp	Current temperature in degrees (°C)
Totalvolt	Voltage (V)
Current	Discharge (A)
Res Cap	Remaining Capacity (A/h)
Full Cap	Total Capacity (A/h)
RelChargeState	Default Loader Status (%)
AbsChargeState	Instant charge (%)
Cycle Times	Charging cycles (number)
Max Uncharge Time	Maximum time in which no charge was made (Hr)
Last Uncharge Time	
Total Cell	Number (individual)
Cell Voltage 1	Cell Voltage 1 (mV)
Cell Voltage 2	Cell Voltage 2 (mV)
Cell Voltage n	Cell Voltage n (mV)
HW	Hardware Version
SW	Software Version

NOTE: If no data is detected, "--" is displayed.

8.7.2.2 Controller Information

Press the **+** or **-** (<0.5S) button and select "CTRL Info", and then press the **⏻** (<0.5S) button to confirm. Now you can read the controller information. To Exit press the **⏻** (<0.5S) button, or select "Back" to return to the "Information" interface.

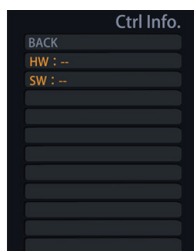

8.7.2.3 Display Information

Press the **+** or **-** (<0.5S) button and select "Display Info", then press the **⏻** (<0.5S) button to read the software and hardware data in the display. To Exit press the **⏻** (<0.5S) button, or select "Back" to return to the "Information" interface.



8.7.2.4 Torque Information

Press the **+** or **-** (<0.5S) button and select "Torque info", then press the (<0.5S) **⏻** button to read the software and hardware data in the display. To Exit press the **⏻** (<0.5S) button, or select "Back" to return to the "Information" interface.

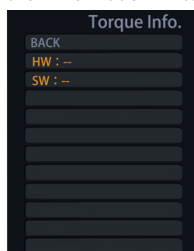

8.7.2.5 Error Code

Press the **+** or **-** (<0.5S) button and select "Error Code", and then press the **⏻** (<0.5S) button to confirm. It shows error information for the last ten errors of the pedelec. Error code "00" means that there is no error. To Exit press the **⏻** (<0.5S) button, or select "Back" to return to the "Information" interface.

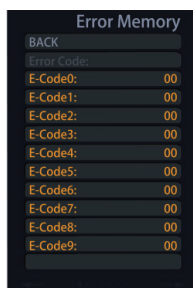

8.7.2.6 Warning Code

Press the **+** or **-** (<0.5S) button and select "Warning Code", and then press the **⏻** (<0.5S) button to confirm. It shows information for the last ten warning of the pedelec. "W-code 0" means that the latest warning. "00" means that there is no warning. To Exit press the **⏻** (<0.5S) button, or select "Back" to return to the "Information" interface.

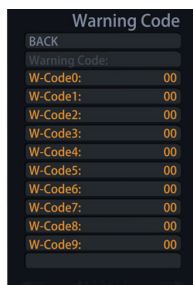

8.8 Error Code Definition



The display can show the errors of a pedelec. If an error is detected, the wrench icon  appears on the display and one of the following error codes will be displayed.

Note: Please read the description of the error code carefully. If you see the error code, restart the system first. If the problem is not resolved, please contact your dealer.

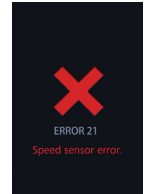

Error	Declaration	Troubleshooting
04	The throttle is not back in its correct position.	Check the throttle can adjust back into its correct position, if the situation does not improve, please change to a new throttle.(only with this function)
05	The throttle has fault.	1. Check the connector of throttle whether they are correctly connected. 2. Disconnect the throttle, If the problem still occurs, please contact your retailer. (only with this function)
07	Overvoltage protection	1. Remove the battery. 2. Re-Insert the battery. 3. If the problem persists, please contact your retailer.
08	Error with the hall sensor signal inside the motor	Please contact your retailer.
09	Error with the Engine phase's	Please contact your retailer.
10	The temperature inside the engine has reached its maximum protection value	1. Turn off the system and allow the Pedelec to cool down. 2. If the problem persists, please contact your retailer.
11	The temperature sensor inside the motor has an error	Please contact your retailer.
12	Error with the current sensor in the controller	Please contact your retailer.
13	Error with the temperature sensor inside of the battery	Please contact your retailer.
14	The protection temperature inside the controller has reached its maximum protection value	1. Turn off the system and let the pedelec cool down. 2. If the problem persists, please contact your retailer.

Error	Declaration	Troubleshooting
15	Error with the temperature sensor inside the controller	Please contact your retailer.
21	Speed sensor Error	<ol style="list-style-type: none"> 1. Restart the system 2. Check that the magnet attached to the spoke is aligned with the speed sensor and that the distance is around 5 mm. 3. Check that the speed sensor connector is connected correctly. 4. If the error persists, please contact your retailer.
25	Torque signal Error	<ol style="list-style-type: none"> 1. Check that all connections are connected correctly. 2. If the error persists, please contact your retailer.
26	Speed signal of the torque sensor has an error	<ol style="list-style-type: none"> 1. Check the connector from the speed sensor to make sure it is connected correctly. 2. Check the speed sensor for signs of damage. 3. If the problem persists, please contact your retailer.
27	Overcurrent from controller	Please contact your retailer.
30	Communication problem	<ol style="list-style-type: none"> 1. Check all connections are correctly connected. 2. If the error persists, please contact your retailer.
33	Brake signal has an error (If brake sensors are fitted)	<ol style="list-style-type: none"> 1. Check all connectors. 2. If the error continues to occur, please contact your retailer.
35	Detection circuit for 15V has an error	Please contact your retailer.
36	Detection circuit on the keypad has an error	Please contact your retailer.
37	WDT circuit is faulty	Please contact your retailer.
41	Total voltage from the battery is too high	Please contact your retailer.
42	Total voltage from the battery is too low	Please contact your retailer.

Error	Declaration	Troubleshooting
43	Total power from the battery cells is too high	Please contact your retailer.
44	Voltage of the single cell is too high	Please contact your retailer.
45	Temperature from the battery is too high	Please contact your retailer.
46	The temperature of the battery is too low	Please contact your retailer.
47	SOC of the battery is too high	Please contact your retailer.
48	SOC of the battery is too low	Please contact your retailer.
51	The display is not compatible with your DIY system.	Please contact your retailer to purchase the compatible displays.
52	The controller is not compatible with your DIY system.	Please contact your retailer to purchase the compatible drive units.
53	The battery is not compatible with your DIY system.	Please contact your retailer to purchase the compatible batteries.
54	The battery and controller are not compatible with your DIY system.	Please contact your retailer to purchase the compatible batteries and drive units.
55	The battery and display are not compatible with your DIY system.	Please contact your retailer to purchase the compatible batteries and displays.
56	The controller and display are not compatible with your DIY system.	Please contact your retailer to purchase the compatible drive units and displays.
61	Switching detection defect	Please contact your retailer. (only with this function)
62	Electronic derailleur cannot release.	Please contact your retailer. (only with this function)
71	Electronic lock is jammed	Please contact your retailer. (only with this function)
81	Bluetooth module has an error	Please contact your retailer. (only with this function)

9 BATTERY

9.1 Introductions

9.1.1 Battery

 Your pedelec can be equipped with batteries of different capacities which are compatible with your DIY system.

(Depending on the manufacturer's configuration)

Model numbers:

BT F23.480.C



 Before use, read the information on the label of the battery.





 Please only use the original BAFANG charger to charge the battery. The battery is not fully charged when it is delivered. Please charge the battery completely before its first use and before storage.

- It is recommended to charge the battery after use. Deep discharge is harmful to the battery. Never fully discharge the battery. If the battery remains uncharged for an extended period, this will damage the capacity of the battery. For storage, the recommended capacity of the battery should be between (60-80%).
- Do not charge the battery longer than the charging time specified in the "SPECIFICATION" table.

9.1.1.1 Safety instructions

 It is possible for the battery to cause a fire, explosion or hazard if the battery is connected to an incompatible system. Do not open, disassemble or pierce the battery as this can lead to short circuits, leaks, fires or explosions. If the battery falls to the ground, or exposed to a blow or similar event, do not continue to use the battery, take it to your retailer to examine. Use only the original charger supplied with the battery, otherwise it can lead to an explosion or permanent damage. The disposal of used batteries must be carried out at a suitable disposal point.

 **The battery should always be kept out of reach of children. The use of the charger or the battery is not suitable for children.**

 **Do not touch a leaking battery.**
 Leaking electrolytes can seep into the skin and cause discomfort. If battery acid encounters the eyes, do not rub it! Immediately wash your eyes carefully with clean water and consult a doctor or a hospital.

 **A faulty battery can lead to overheating, smoking or burning.**
 When the battery gets hot keep yourself and others a safe distance away from the battery. In case of damage or heat, you should avoid touching the battery. See chapter ("Environmental tips").

 **Do not disassemble the battery.**
 The battery contains protective components to avoid danger. Incorrect handling, such as improper disassembly, can destroy the protective functions and lead to overheating, smoke and explosion.

 **Do not intentionally short-circuit the battery.**
 Never allow the plus and minus connectors to come into contact with each other. Do not allow the battery to come into contact with

metal objects. It is dangerous if the battery is short-circuited. As it can lead to overheating, smoke, explosion or burning.



Do not heat or burn the battery.

An overheated or ignited battery can cause battery cells to explode.



Do not place the battery under direct sunlight for long time.



Do not use the battery near heat sources.

Do not use the battery near an open flame or at temperatures above 60 °C. High temperatures can cause the battery to burn or explode.



Do not charge the battery near open fire or in direct sunlight.

This can cause errors or internal problems inside the battery, also damaging the protective function. It can lead to abnormal chemical reactions or malfunctions that lead to overheating, smoke and explosion.



Do not damage the battery.

The battery must not be dropped or damaged. This can lead to overheating, smoke and explosion. Never submerge the battery in water.



Do not charge the battery directly from the socket or a cigarette lighter in the car.

High voltage and excessive current will damage the battery and reduce its lifespan. It can lead to overheating, smoke and explosion.

9.1.1.2 Battery Storage



If you do not use your pedelec for a long time, remove the battery, and charge about (60-80%) on. Store the battery separately in a suitable dry place.

- Avoid direct sunlight from the sun, as it may cause it to overheat, and cause internal problems in the battery. It can lead to abnormal chemical reactions or malfunctions that lead to overheating, smoke and explosion.

- To prevent a deep discharge, the battery is put into sleep mode after a certain time.
- Do not extend the battery to temperatures below the permissible storage temperature of -10 °C to 35 °C. Note that temperatures of about 45 °C are common near heaters, in direct sunlight or in overheated vehicle interiors.



Do not continue to use the battery if you notice that it gets hot during operation, charging or storage, develops a strong smell, changes its appearance, or is otherwise unusual. Do not continue to use the battery and have it checked by a retailer before using it again.

9.1.1.3 Battery wear



The battery can be charged 600 times. The battery capacity decreases during this time, thus reducing the range of the pedelec. If the range is not enough depending on the capacity of the battery may need to be replaced.

9.1.1.4 Pedelec riding distance



It is best to charge the battery at room temperatures and insert the battery just before the start of the journey. The discharge cycle of the battery can be affected by:

- Used pedal power
- Total weight (load and driver)
- Tire air pressure
- Headwind
- Ambient temperature
- Road/underground condition
- selected speed level
- Slope
- Battery charge level
- Age
- Remaining capacity of the battery

9.1.2 Charger

- i** The charger is specially designed for charging lithium-ion batteries. It is equipped with an integrated fuse and overcharging protection.



9.1.2.1 Battery charger Instructions

- !** Read the instructions on the external label of your charger before using the battery.



- !** To prevent the risk of electric shock, you should never open the charger. Maintenance work should be dealt with by qualified service personnel. Be sure to read the information about your charger before use! Unplug the power plug before connecting the battery to the charger or removing it from the charger.

- !** Keep the charger away from children and animals. In the event of malfunction or damage, it may result in a fire or electric shock.

- The charger must not be operated by children or people with limited sensory or mental disabilities.
- Do not use your charger if it is moist or dusty.
- Avoid direct sunlight.

- Disconnect the charger from the power supply when not in use.
- Use only the original Bafang charger that came with your pedelec.
- Do not cover the charger while in use. There is the possibility of short circuits or fires.
- When cleaning the charger, unplug it from the power outlet first.
- Stop the Charge process if the charging cycle lasts longer than the length listed in the Specifications table.

9.2 Operation

9.2.1 Installing Your Battery

- i** When pushing the battery into position. Make sure that the battery has clicked into the locking mechanism before you set off.

First rotate the lock to the open position, then insert the battery into the slide rail, and push the battery into the down bracket. Finally rotate the key and lock the battery.

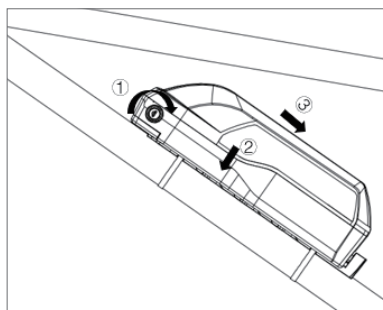

NOTE: The key can only be removed after the battery is locked, otherwise it can not be removed.

9.2.2 Removing the Battery

First rotate the lock to the open position, then pull the battery up along the slide rail on the down bracket. Finally remove the battery from slide rail.

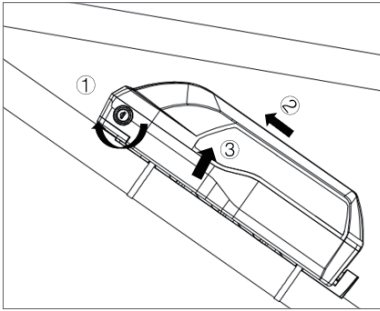

 Hold the battery tightly as it is heavy.

9.2.3 Removing the Battery Lock

NOTE: If the lock is damaged or the key is lost, please contact the after-sales service.

First unscrew six screws on the battery, remove the cover and take out the lock from battery.

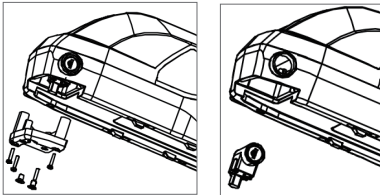

9.2.4 Charging the Battery

 Use only the original battery charger supplied to you, as there is a risk of fire or explosion if the incorrect charger is used.

 You can charge your battery when mounted on the bike or when it is removed.

 Lithium-ion batteries are not subject to any memory effect. You can recharge your battery at any time, even after short journeys.

Charge the battery at temperatures between 0°C and 45°C (ideally at room temperature approx. 20 °C). Give your battery enough time to reach this temperature before charging.

 Before charging, read the instructions on the charger.

1. First insert the plug of charger into the power socket, then the LED will blink in green.



2. As soon as the charger is connected to the battery, the LED will turn to light in green (3 sec.), then turn to long light in red, it will start to charge.



- When charging is complete, the LED changes from red to green.



- If the LED flashes in red during the charging, it indicates that the charging is abnormal.



 The charging time depends on several factors. It can vary greatly depending on the temperature, age, use and capacity of the battery. For information on the charging time of your battery, see "SPECIFICATION"

When the battery is fully charged, the charging process stops automatically. Unplug the connector from the battery and then removed from the mains.

9.2.4.1 Safety instructions

 Use only the battery charger.







Make sure you are using the correct mains voltage. The required mains voltage is indicated on the charger.

- Do not touch the power plug with wet hands. There is a risk of electric shock.
- Note: A sudden rise in temperature can cause condensation in the battery. To avoid condensation, charge the battery at the same place where it is stored.
- Before using, check that the charger, cable and plug are not damaged. Do not use the charger, if you notice any damage. There is a risk of electric shock.
- Charge the battery only in a well-ventilated room.
- Do not cover the charger/battery during charging. There is a risk of overheating, fire or explosion.
- Charge the battery in a dry place, and on a non-flammable surface.
-  The battery must be charged at least once every 3 months to avoid damage or destruction of the cells.
-  If the charging process takes longer than usual, the battery may be damaged. In this case, stop charging immediately. Have the battery and charger checked by your retailer to prevent further damage.



Errors - Causes and Solutions

Description	Cause	Solution
The operating display does not light up.	Power plug is not correctly connected to the power supply	Check that all connectors on the charger are correctly connected to the power supply.
The charging indicator is not lit.	The battery may be malfunctioning.	Contact your retailer.
The charging indicator does not glow permanently red.	The battery may be malfunctioning.	Contact your retailer.





9.2.5 LED Display for Charging Status and Charging capacity

-  The battery must be activated before it can be used.
-  When the battery is activated, long press the button “” (> 10 seconds), and the LED will be light up one by one. After releasing the button, the battery will enter a deep sleep state.
-  In the deep sleep state, press the button “” (3 to 5 seconds) to activate the battery and the LED will all light up the LED for 3 seconds.
-  To avoid the battery discharge from becoming damaged, the battery management system puts the battery into sleep mode. In sleep mode, no function is given for technical reasons.

9.2.5.1 LED indication

 When the battery is activated, press the button “” (for 1 second) and the LED displays the current power level, if the first LED flickers, it means that the battery needs to charge. See the table below:

Charge status indication

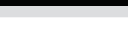
LED	LED state	SOC
	First LED blinks	≤ 5 %
	One LED light turns green	5–20 %
	2 LED lights turn green	20–40 %
	3 LED lights turn green	40–60 %
	4 LED lights turn green	60–80 %
	5 LED lights turn green	≥ 80 %

9.3 Specifications

9.3.1 Battery

Primary Settings	BT F23.480.C
Rated voltage	50.4 DCV
Nominal Capacity	9.5 Ah
Min Capacity	9.2 Ah (@1C/25°C Discharge)
Power	480 Wh
Charging time	3h with 4A Charger
Storage (At 50% SOC & -10° ~ 35 °C)	3 months
Riding Distance*	ca. 50km(250W motor)
Dimensions (L*W*H)	375*101*123mm
Weight (appr.)	3.3 KG
Charger	Special 5P charger

* Ideal conditions: Flat terrain, approx. 15km/h average speed, no headwind, approx. 20 °C ambient temperature, high-quality bike components, tire tread and pressure with minimal rolling resistance, experienced eBike rider(always shifts gears correctly), additional weight(excluding bike weight)<70kg.

9.3.2 Charger

- Input voltage: 100 Vac–240 Vac, 47–63 Hz
- Max output voltage: 58.8 ± 0.2 V
- Output current: 4 ± 0.2 A
- Minimum battery charge voltage: 28 ± 1 V
- Temperature protection: NTC $< 0 \pm 3$ °C
or NTC $> 65 \pm 3$ °C
- AC Connector: Meet local standard
- Certificate: FCC, UL62368, RoHs