

# SAFETY PRECAUTIONS

## BEFORE USE

- This manual is intended to describe the items that you should be aware of when using the product in order to prevent harm to you and other people and damage to property. Please be sure to observe it for safe use.
- Please read this manual carefully before use to ensure correct and safe use. Also, please read the quality label attached to the product.
- The contents of this manual and precautions for use describe precautions to prevent incorrect usage and accidents. Please keep it in a safe place and read it when necessary.
- When renting or transferring the product to a third party, be sure to attach this manual and fully explain the handling method.

\*The warranty period is one year after delivery. If a failure occurs due to our responsibility within the above warranty period, we will replace or repair it with a replacement product free of charge. Please do not hesitate to contact the after-sales service department: ✉ Dowinx@vip.126.com

## ! SAFETY PRECAUTIONS

! The precautions written here are to prevent harm or damage to you or others.  
! All of these are important contents for safe use, so be sure to observe them.

- Do not disassemble or lubricate the gas cylinder. It may explode and cause injury.
- Please do not incinerate. The high pressure gas in the gas cylinder may explode or emit toxic gas.
- Do not put your hand in the gap between the moving parts. You may get injured.
- Do not operate the up / down adjustment lever on the seat surface while the seat is vacant. The seat and back may rise sharply and cause injury.
- Do not use the product as it is found. The main body may break and you may get injured.
- Do not use on slippery floors. You may fall and get injured.
- As it is an assembly type, tighten the screws firmly to assemble. Also, if any rattling occurs due to loosening of bolts or screws during use, be sure to retighten. If you use it with the bolts and screws loose, the main body may break and you may be injured.
- Please do not let the infant sit alone. You may fall and get injured.
- Please do not modify.

## PRECAUTIONS FOR USE

- This product is for indoor or indoor use. Outdoor use or getting wet may cause malfunction, rust or discoloration.
- Avoid using the product in a place exposed to direct sunlight or heat such as a stove, or in a place with significant humidity or dryness.
- Tighten the bolts and screws regularly every two-month.
- Tap the cloth part of the seat with your hands or vacuum the cloth to remove dust. Otherwise, wipe off the dirt with a dry cloth or a lightly moistened cloth. (Wipe off the water from the steel part well.) Do not use thinner, benzine, cleanser, etc.

# PARTS CHECKING

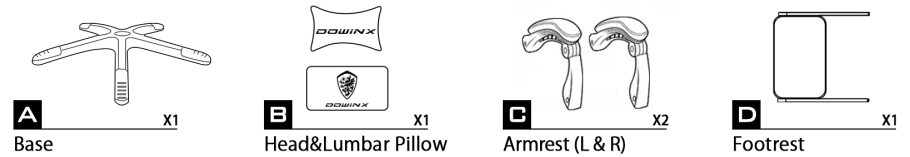

## Parts box 1

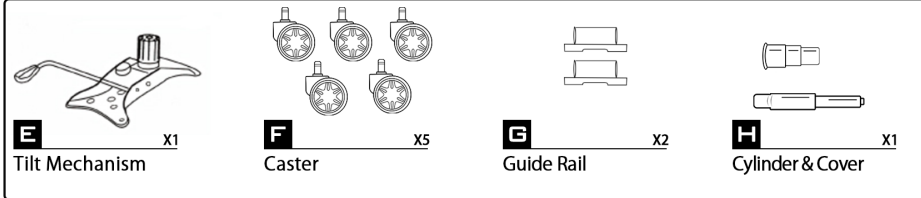

## Parts box 2

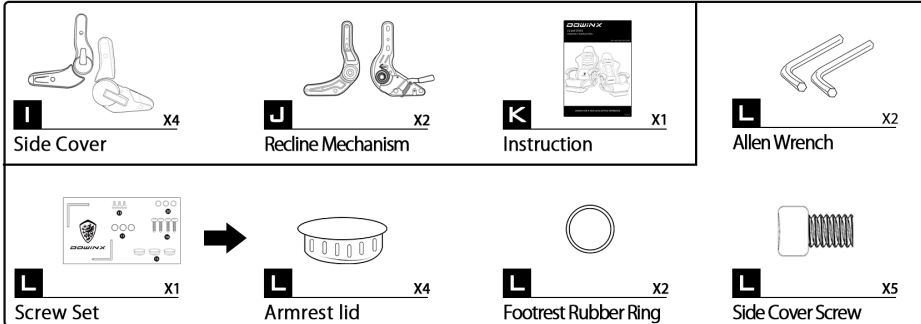

The backrest and cushion screws are already pre-installed so they won't be lost in transit

M Backrest x1		Reclining Mechanism Screws	M8*25MM	4
		Armrest Screws	M8*30MM	2
N Cushion x1		Guide Rail Screws	M6*30MM	4
		Tilt Mechanism Screws	M8*20MM	4
		Recline Mechanism Screws	M8*25MM	4
		Armrest Screws	M8*30MM	2

# ASSEMBLY INSTRUCTION

## Method of screwing Do not tighten the screws in the beginning

● If you tighten the screws in the beginning, the one of screw holes will not be aligned and you will not be able to assemble. It also will cause overall distortion.

1. Temporarily tighten all screws to about 80%
2. Finally, tighten all the screws firmly



### How to tighten the diagonal screws

- ① Install the first screw into any hole and then install the second screw diagonally.
- ② Install the remaining screws.

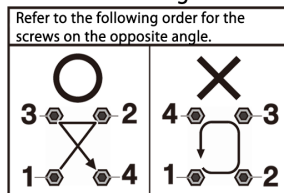

This manual is a brief explanation of the main points, so the installation details are not fully displayed. If you've never assembled a gaming chair, we recommend you scan the below QR code and refer to the installation video.



<https://dowinx.com/pages/help>

## Installation of casters

-Turn the base over and insert the casters firmly as far as it will go.

\* To prevent the casters from coming off, it is a bit difficult to insert.

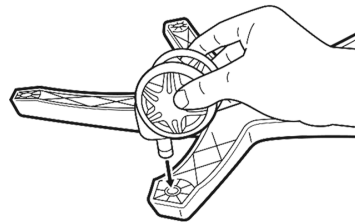

## Installation of base

-Insert the gas cylinder and cover into the base as shown.

\* The cylinder is coated with lubricating oil. Don't make your hands, clothes, or floor dirty.

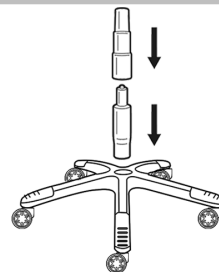

## Installation of tilt mechanism and guide rail

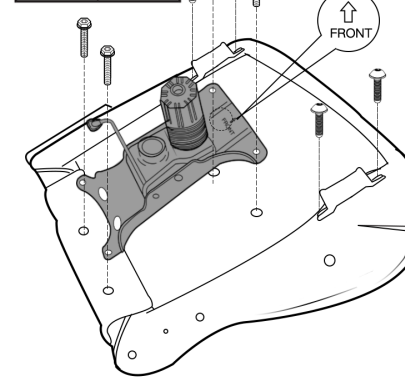

Firstly, remove the all screws attached to the bottom and then install the rails. Place the side hole of the guide rail on the outside to refer to the figure below. Do not tighten the rail screws during this step.

Next, install the tilt mechanism. Turn the front sign on the mechanism in the direction of the guide. Tighten the screws in order, referring to the example photo.

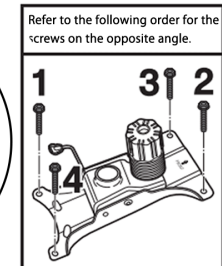
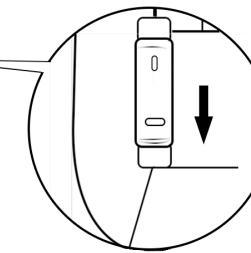

## Installation of footrest

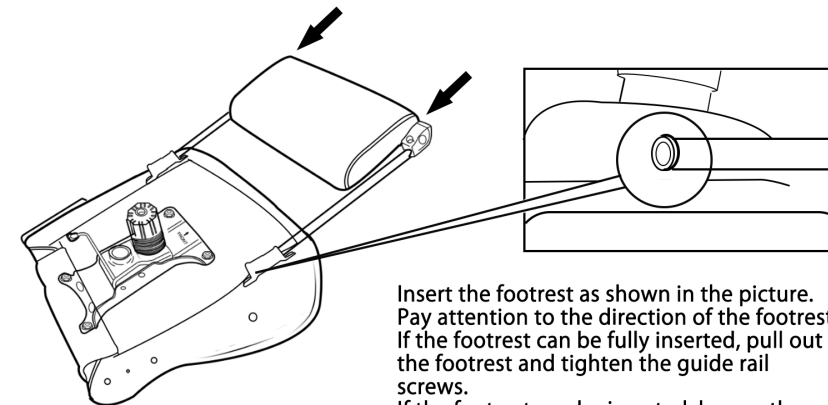

Insert the footrest as shown in the picture. Pay attention to the direction of the footrest. If the footrest can be fully inserted, pull out the footrest and tighten the guide rail screws. If the footrest can be inserted, loosen the screw on the guide rail and adjust the guide rail. After confirming the all screws tightened, install the rubber ring finally.

# ASSEMBLY INSTRUCTION

## Attach the cushion to the base

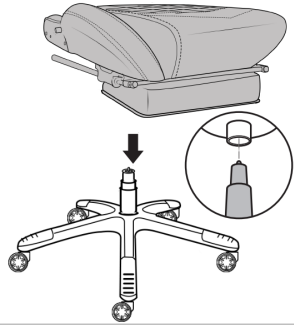

First, attach the base to the gas cylinder. Then attach the gas cylinder to the tilt mechanism. Please check if you inserted it vertically. \*If inserted at an angle, the lift function may be unusable.

## Installation of reclining mechanism

Remove the four reclining mechanism screws on both sides of the cushion. Attach the reclining mechanism to the seat cushion and tighten the screws.

\* Before the installation is completed, the reclining mechanism function is unusable. Do not pull on the handle.

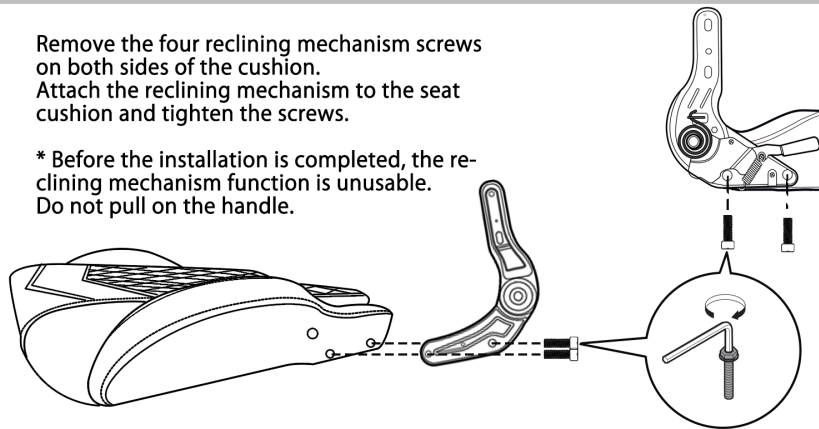

## Installation of headrest and lumbar support

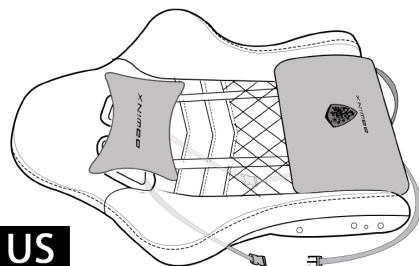

Install the lumbar support and headrest as shown. Thread the belt through the hole to ensure vertical adjustment of lumbar support. When installing the headrest, please refer to the drawing and select the comfortable position.

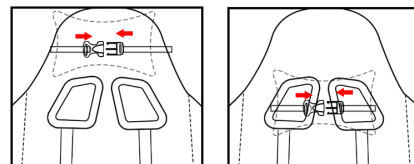

## Install the backrest on the cushion



Unscrew the four reclining mechanisms on either side of the backrest. Insert the backrest. Then install the screws on the both side with the handle. Do not tighten all screws before the installation is completed. After adjusting the angle of the backrest, tighten the four screws on the both sides in the order.

Attach the reclining mechanism cover to the metal mechanism. Install the two bottom covers first, then the top.

\*Make sure that the holes are aligned, and then tighten the screws pressing the side cover so that it won't slip. If installed directly, the screws may not fit in the holes.

## Installation of armrests

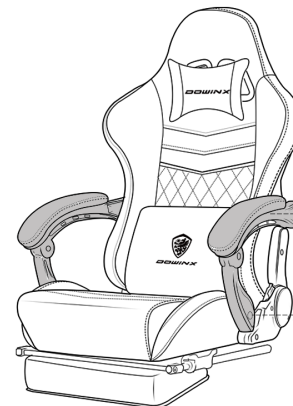

Remove the four armrest screws on the both sides of the seat cushion and backrest. Insert the two armrests and tighten the screws. Attach the lid to the screw hole to complete the all installation steps.

Should you find any inconsistencies or have questions about your Dowinx gaming chair, please contact us for assistance. ✉Dowinx@vip.126.com

# FEATURES

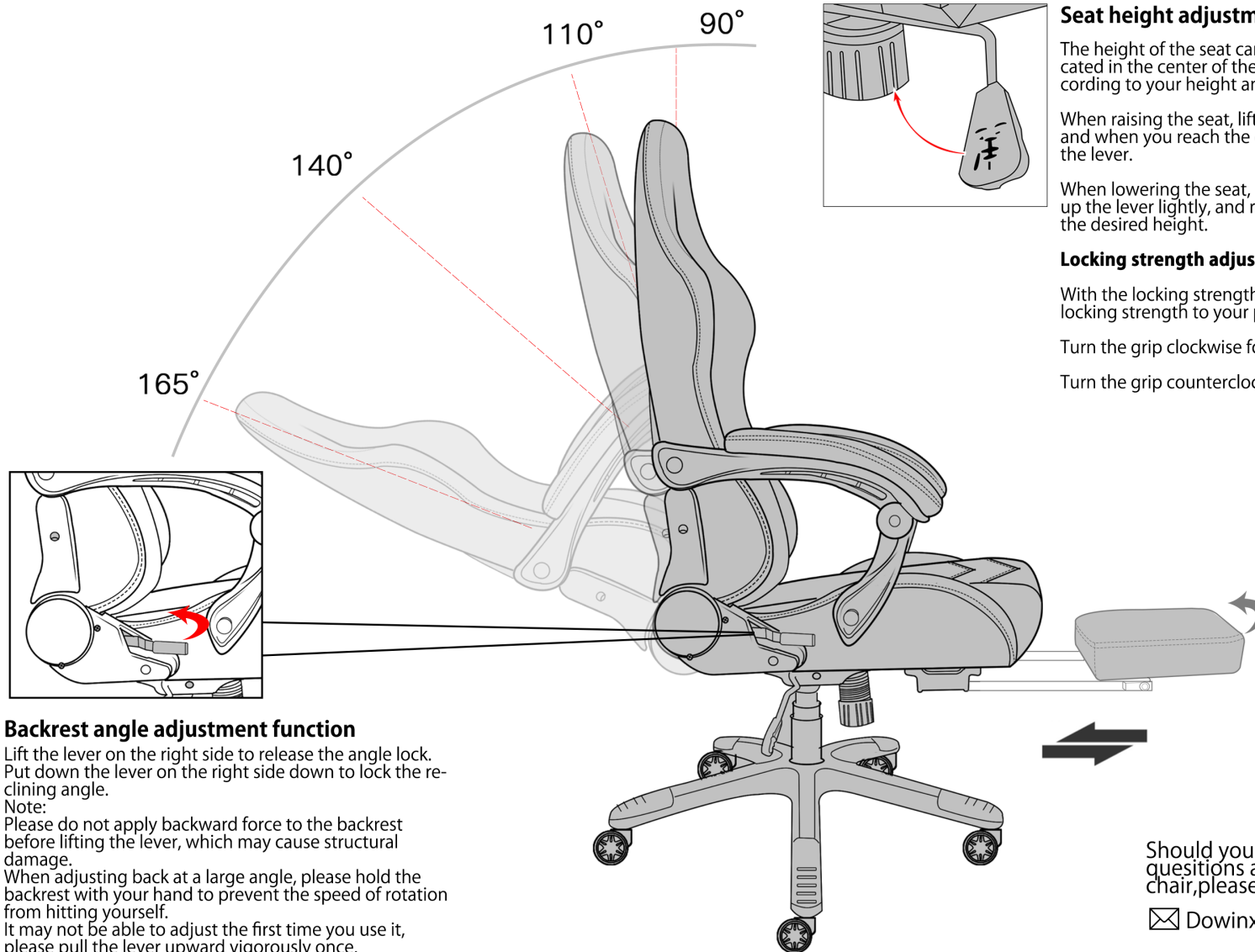

### Backrest angle adjustment function

Lift the lever on the right side to release the angle lock. Put down the lever on the right side down to lock the reclining angle.

Note:

Please do not apply backward force to the backrest before lifting the lever, which may cause structural damage.

When adjusting back at a large angle, please hold the backrest with your hand to prevent the speed of rotation from hitting yourself.

It may not be able to adjust the first time you use it, please pull the lever upward vigorously once.

### Seat height adjustment function

The height of the seat can be adjusted with the seat lift lever located in the center of the right hand side of the seat. Adjust according to your height and desk height.

When raising the seat, lift your hips and pull up the lever lightly, and when you reach the desired height, release your hand from the lever.

When lowering the seat, sit deeply in the center of the seat, pull up the lever lightly, and release the lever when it is lowered to the desired height.

### Locking strength adjustment grip

With the locking strength adjustment grip, you can adjust the locking strength to your preferences.

Turn the grip clockwise for stronger movement.

Turn the grip counterclockwise to weaken the movement.

Should you find any inconsistencies or have questions about your Dowinx gaming chair, please contact us for assistance.

✉ [Dowinx@vip.126.com](mailto:Dowinx@vip.126.com)