



Internet Radio Tuner

WR-10

User Manual



Please read this user manual carefully before using the receiver

Contents

1. Introduction to the WR-10 Internet Radio Tuner	3
2. Internet Radio Tuner Connections	5
3. Location of Controls	6
4. Remote control	7
5. Choosing options and functions	8
6. Network Setup	9
7. Overview of Radio Tuner modes and functions	11
8. My Favorite	13
9. Internet Radio	14
10. Media Center	16
11. DAB+/DAB Radio (Digital Audio Broadcasting)	17
12. FM Radio	18
13. Bluetooth Speaker	19
14. Alarm	20
15. Sleep Timer	21
16. Configuration	22
17. Skytune Web Application for Internet Radio www.skytune.net	24
18. Problems and Solutions	27
19. Technical Specification	30

Introduction to the WR-10 Internet Radio Tuner

The WR-10 Internet Radio Tuner is an audio component for integration into your home HiFi System as an added source of audio entertainment.

The radio has eight different operating modes providing a comprehensive set of enhancements to audio entertainment and a gateway into the world of digital audio.

- 1) Wireless Wi-Fi or Wired LAN (Internet connected)
 - Internet Radio with more than 30 thousand radio stations world wide
 - Local Radio streamed over the Internet for high quality
- 2) Media Center (Wi-Fi - no Internet)
 - Play music streamed over the Wi-Fi network by a UPnP or DLNA server e.g. smart phone, laptop.
- 3) Wireless (direct broadcast – no Internet)
 - DAB & DAB+ Radio (Digital Audio Broadcast) for high quality digital audio – not available in all countries
 - FM Radio
- 4) Wireless (Bluetooth – no Internet)
 - Play audio transmitted from a Bluetooth source e.g. smart phone, Laptop.
- 5) Timer (no Wi-Fi and Internet)
 - Adjustable timer to delay putting the Radio Tuner into Standby mode
- 6) Alarm (no Wi-Fi and Internet)
 - Wake up alarm Clock with option to automatically set the Time of Day to Internet time standard
- 7) Configuration (no Wi-Fi and Internet)
 - Set up, options and information center

The illustration on pages shows the WR-10 integrated into a HiFi system ready to play in all modes.

Precautions

Use only the A/C Power Adaptor supplied with the Radio Tuner or permanent damage to the radio will occur and may be hazardous.

To clean use only a damp cloth and dry with a clean towel - keep away from all liquids.

To avoid loss of warranty do not attempt to repair or remove the cover for any reason.

Internet Radio Tuner Connections

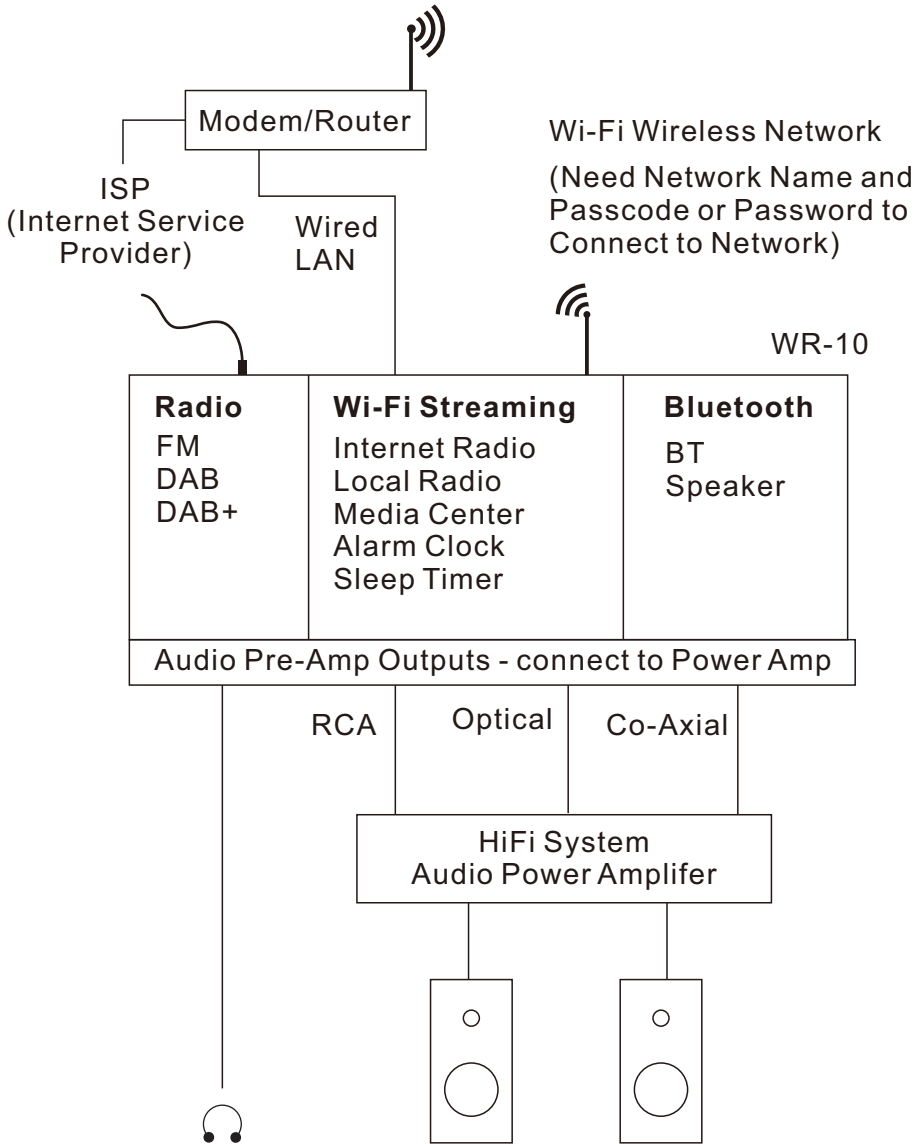

3

Location of Controls

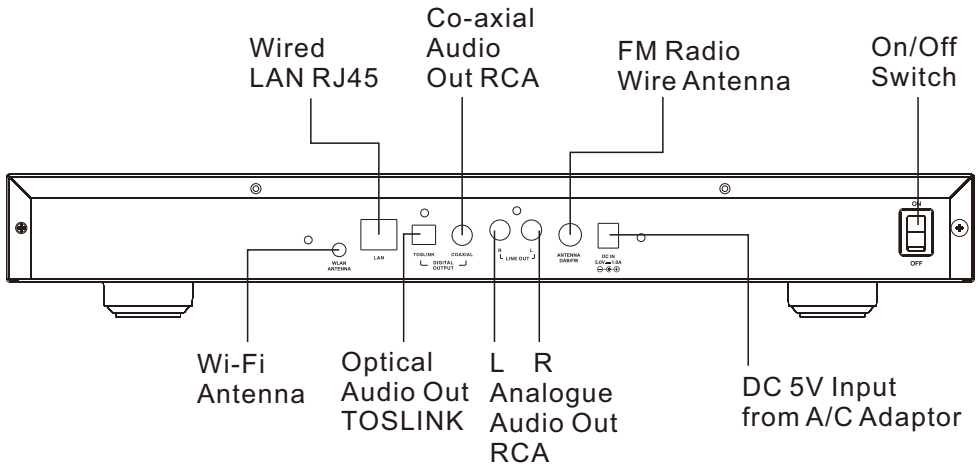
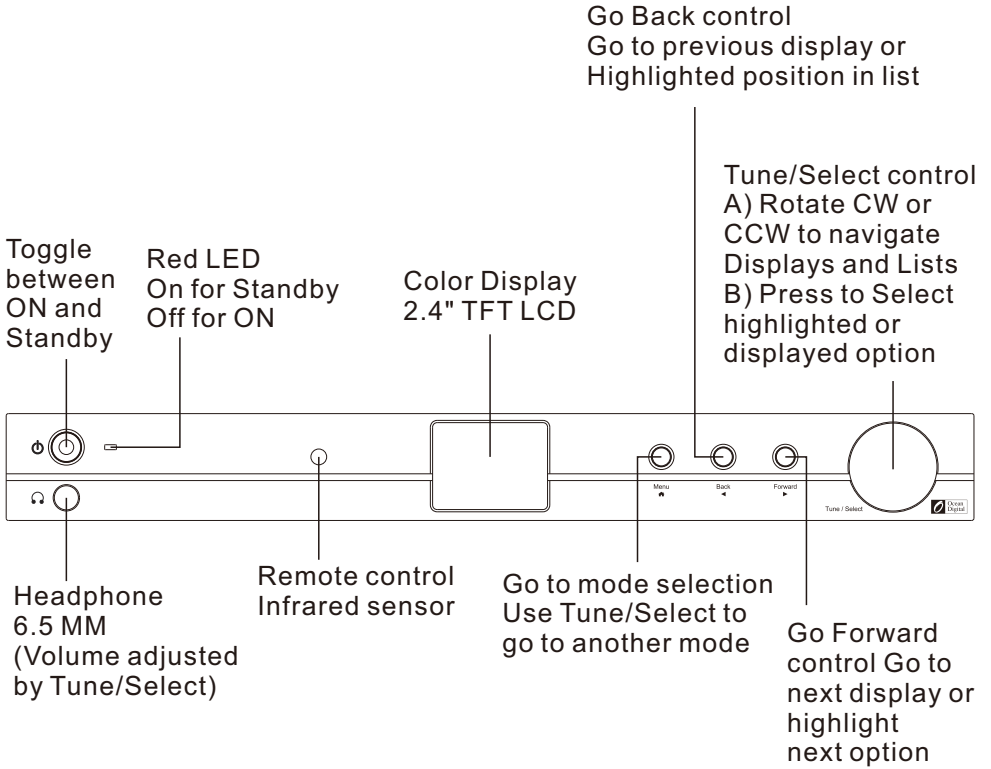

Remote control

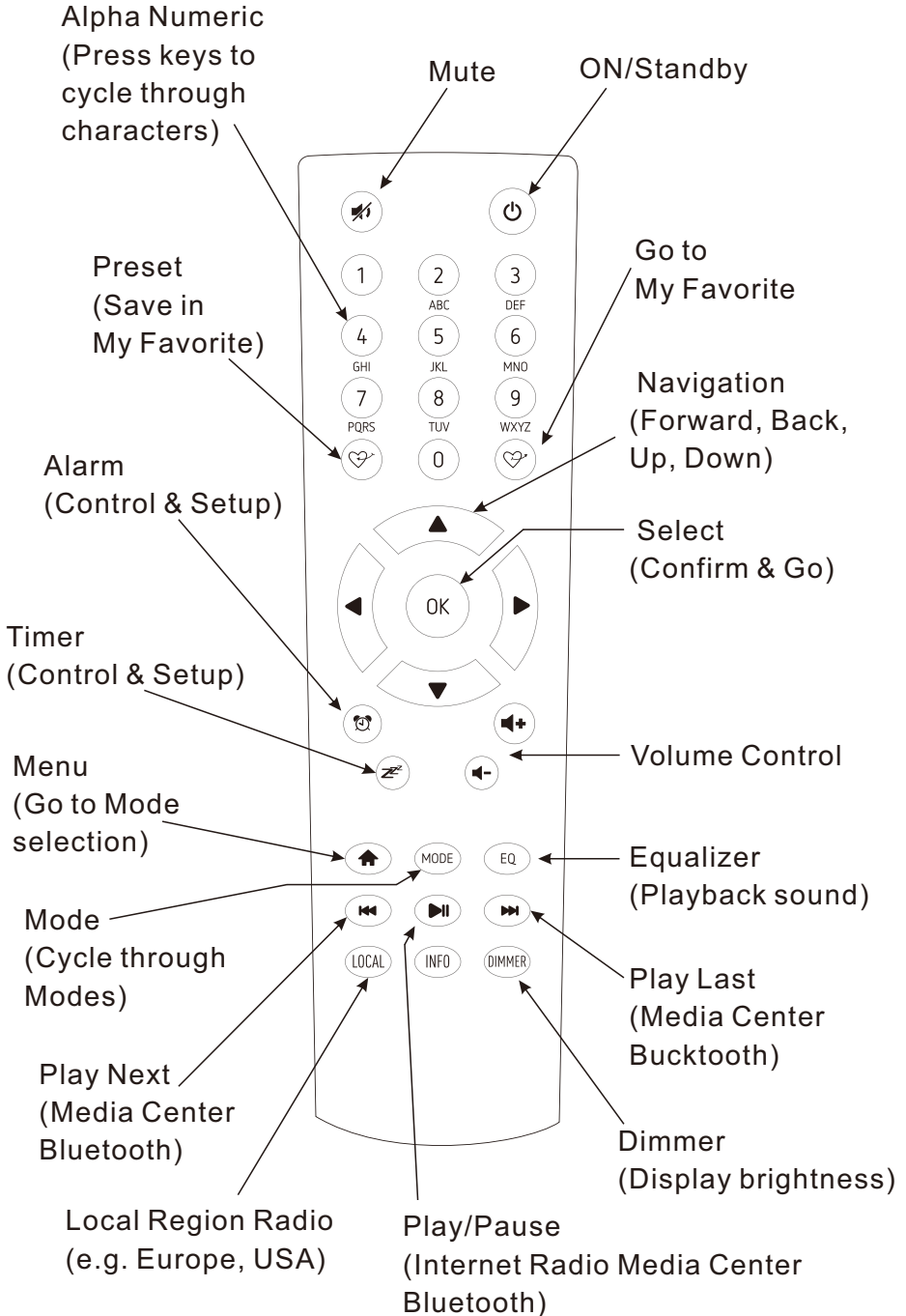

All user input is information that the Radio Tuner uses to provide the desired audio entertainment with select (enter) a confirmation and go command.

The **Tune/Select** control knob is used for navigating LCD displays and lists by rotating clockwise (CW) or counter clockwise (CCW) to change or highlight information displayed on the LCD screen and confirms a selection when it is pressed and released.

The **Forward** (►) and **Back** (◀) buttons can also be used to move to the next or back to the last display or position in lists but all inputs must be confirmed by pressing and releasing the **Tune/Select** knob.

Throughout this manual “Select” will mean navigating through option lists or display screens to highlight desired selection and confirming it by pressing and releasing the **Tune/Select** knob.

The remote controller can also be used to control the Radio Tuner with the center navigation buttons (◀ ▼ ► ▲) and OK button to confirm selections.

Many other controls are available on the remote controller with discrete buttons for many functions e.g. volume up or down.

The Internet Radio Tuner must have a high bandwidth internet connection and a wired (Ethernet) or wireless (Wi-Fi) home network connected to it to be fully functional.

To configure the network plug in the A/C Power adaptor into a wall socket and the back of the Radio Tuner and then turn On the rear panel On/Off switch.

Wireless LAN (Wi-Fi)

The first time the Radio Tuner is turned on after leaving the factory a Configure Network wizard is automatically started:

- 1) Highlight and Select Yes to connect to the Wi-Fi network
- 2) The display will change and display a list of options – Select Add AP (Scan)
- 3) The display will show a list of available networks – Select your network
- 4) The display will ask for your passcode/password – highlight the first digit and move forward, highlight the next digit and move forward. Repeat until the last digit is highlighted. Do not move forward. While the last digit is highlighted Select by pressing the **Tune/Select** knob or the OK button on the remote controller.
- 5) If the connection is successful “Association Complete” will be displayed briefly.

To repeat the above procedure, or if the Configure Network wizard does not automatically start, the network can be connected by using the Configuration mode.

- 1) Press the Menu button to go to the mode selection options. Use the **Tune/Select** knob and navigate to configuration
- 2) Select Configuration
- 3) Select Network

There are three different options to connect to the network from the Configuration mode:

- 1) Repeat steps 2) through 5) above.
- 2) Select Add AP (WPS button) – Press WPS button on your router within 2 minutes to complete the connection.
- 3) Select Add AP (Smart Config) – Download an APP (e.g. EspTouch) that configures ESP32 devices (e.g. WR-10) and install on a smart phone, tablet or other device that can use APPs. Start the APP to complete the connection.

Connection status is displayed in the top left hand corner of the LCD with the Wi-Fi symbol and signal strength bars ().

For best Wi-Fi performance, limit “drop outs” (interruptions) the Wi-Fi Channels must be set according to the location of the Radio Tuner e.g. China, USA, Europe. The factory default is China.

To set the correct location, select Configuration, Network, Wi-Fi Channels and select the correct option.

Wired LAN (Ethernet)

Connection to a router with DHCP enabled will be automatic once the cable is plugged into the RJ45 connector.

Successful installation is indicated by the Ethernet symbol () being displayed in the top left hand corner of the LCD.

Overview of Radio Tuner modes and functions

To Select any mode use the Menu button () on the front panel or the remote controller to display the My Favorite screen:

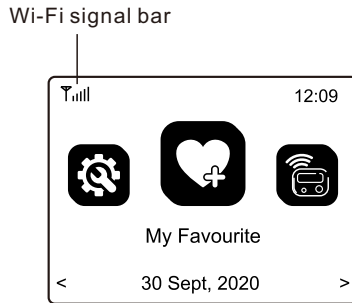



Navigate through the modes to find and Select any of these functions:

- 1) My Favorite – A maximum of 99 previously saved (Preset) favorite listening sources are listed for Selection.
- 2) Internet Radio - Select online radio station from the thousands available on Skytune or by using the History list of previously selected radio stations or use search to find a preferred radio station.
- 3) Media Center – Browse and Select music streaming on your home Wi-Fi network by any UPnP or DLNA compatible server e.g. Smart phone, Tablet, PC, Laptop.
- 4) DAB+/DAB Radio – Play CD quality audio entertainment using the wire antenna if this service is available in your area e.g. not available in USA.
- 5) FM Radio – Play your favorite local radio station using the wire antenna.
- 6) Bluetooth –When “Paired” (connected) to another Bluetooth device use the Radio Tuner as a connection to your Hi-Fi system. Maximum range of the Bluetooth wireless signal is 10 meters (32 feet) but may be reduced by the presence of walls or other obstructions.

Overview of Radio Tuner modes and functions

- 7) Alarm – two separate alarm clocks with the time of day automatically synchronized to the internet time standard.
- 8) Sleep Timer – Select a time delay before the Radio Tuner goes to Standby mode while playing your selected audio entertainment source.
- 9) Configuration – This mode lists all available options and settings to personalize your Radio Tuner.

This mode displays a list of up to a maximum of 99 audio sources that have been Preset (stored) using the Preset button on the remote controller () while an audio source is playing.

Press and hold button until the Preset symbol () is displayed in the top left corner of the LCD.

After the first 99 presets the next Preset will be stored in the first location, the next in the second location; continuing to overwrite each list location until it loops back to the first location again.

To Edit the list highlight a list item then press the Move Forward button () to move to the Edit list function where the item can be moved Up, Down or Deleted from the list.

Select Internet Radio mode using the Menu button on the front panel or the remote controller and navigate the extensive list of worldwide radio stations using these options:

1) Skytune – Select a radio station using the structured lists that aid and reduce the task of finding the right station.



Select Local Radio to listen to a radio station in the region set up in the Configuration mode.

2) Use Search instead of browsing the extensive radio station list by using the initial letters of the desired station name, creating a shorter list of stations the more characters used in the search.

3) The History option will show a list of the radios stations recently selected. Every station selected is added to the list automatically until a maximum of 99 is reached when the next station selected will replace the first station in the list.

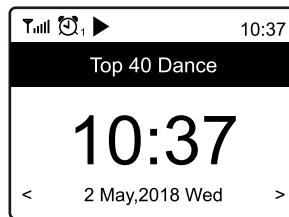
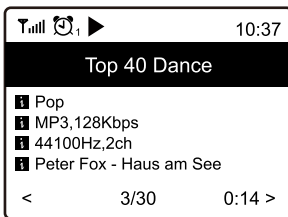
When playing Internet stations information about the station and what is playing will be displayed on the color LCD screen with more information being available by using the Forward (►) button.



Radio Stations can be added to the My Favorite list at anytime a station is playing using the Preset () button on the remote controller. When a Preset is added the icon () is displayed as shown below.

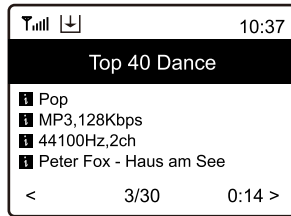

A maximum of 99 Presets can be put in the list before the next Preset will overwrite the first entry.

Use list Edit options to move an entry Down, Up or Delete by highlighting the station to edit and pressing the Forward button (►).

The Radio Tuner supports the industry standard Universal Plug and Play (UPnP) and Digital Living Network Alliance (DLNA) standards.

The Radio Tuner can browse and play music files stored on a UPnP or DLNA server provided the server has been setup to allow sharing of files on the network.

Playback has several modes selected in **Configuration** under **Playback Setup; Repeat All, Repeat One, Shuffle** and **Normal** playback.

Select the **Media Center** to display list of options;



- 1) UPnP – A scan is made to find UPnP and DLNA devices that are streaming on the Wi-Fi network (this can take a few seconds) and when complete options are listed to select music or playlists files. If no UPnP or DLNA servers are found “Empty List” is displayed.
- 2) My Playlist – Your own play list may be created by playing selected music and while it is playing pressing and holding the **Tune/Select** knob or the OK button until the Preset symbol () is displayed.
- 3) Clear My Playlist – Select to delete all music files from My Playlist.

DAB+/DAB Radio (Digital Audio Broadcasting)

DAB+/DAB radio broadcasts CD quality audio but it is only available in certain parts of the world e.g. not available in the USA.

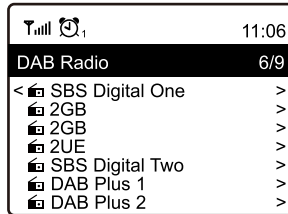
Select DAB Radio and press **Tune/Select** or OK if option to Scan and Preset DAB Stations is displayed or if a list of Preset DAB stations is displayed select station to start listening.



While a station is playing it can be added to the Favorite list by pressing the Preset button () on the remote controller or to display more radio station information use the Forward button ().

Note: Changes to the available DAB/DAB+ stations will not be included in the available station list without a new scan for stations. To rescan go to Configuration > DAB Setup > DAB Full Scan.

Operation of the FM radio is the same as DAB+/DAB radio except that manual tuning is available. Press the **Tune/Select** or OK button until “Tuning” is displayed in the lower right corner of the LCD screen. Pressing and releasing the Forward (▶) or Back (◀) button can be used to go up or down in frequency in small steps.

To exit manual tuning long press **Tune/Select** or OK button.

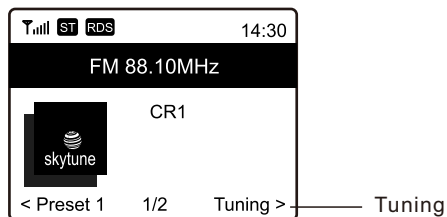

After selecting Bluetooth the display will display the Radio Tuner's Bluetooth identifier code and connection status. If it is not connected "pairing" must take place with the audio source Bluetooth device.

When the Radio Tuner's identification code appears in the list of local Bluetooth devices pair the two devices so that they can recognize each other and will automatically connect whenever the Radio Tuner is in range and in Bluetooth mode.

Once pairing is complete the audio file being transmitted by the Bluetooth device will be received by the Radio Tuner and played the same as any other audio source...

There are two separate wake up alarms that can be set up independently to start at a given time, with selectable sounds, at adjustable volume and with repeat options, on their own or at the same time e.g. set Alarm 1 for normal wake time and Alarm 2 to wake in case of falling asleep again .

Select Alarm 1 or 2 and a setup wizard will start to guide selecting options:

The wake sounds selected can be a tone or other sources in the My Favorites list or FM / DAB radio stations list.

After selecting the final option or adjustment exit the set up wizard by using the Back button (◀).

Set the wake sound volume before sleeping using **Tune/Select** knob or the Up / Down controls on the remote.

After setting up the Alarm check to confirm it is set by the presence of the alarm icon (🕒) at the top, left side of the display.

The Alarm will function while the radio is On or in Standby modes.

Set a time delay before the Radio Tuner automatically goes to Standby mode allowing the listening of audio entertainment while falling asleep.

After selecting the sleep timer a list of delay times will be displayed – select the appropriate time. And exit sleep timer setup by using the back button (◀).

Select Configuration for a list of adjustments and options to be displayed, navigate the list and select the desired function, use the **Forward / Back (► / ◀)** controls to go forward or backwards in the decision tree and make selection.

Network

Wi-Fi Network

- Network Options – Select if the Radio Tuner should be permanently connected or to disconnect if the connection is not active for more than 30 seconds.

- Wi-Fi Channels – Select your location to minimize interruption (drop outs) of the information stream e.g. music.

- Wi-Fi Network
 - Add/Remove AP – Scan local area to find and list available Wi-Fi networks
 - AP:[] – If there is more than one router on the network select the one for the Radio Tuner to use.
 - Signal – Display Wi-Fi signal strength
 - IP [current setting] – Factory Reset default is Dynamic
 - DNS [current setting] - Factory Reset default is Dynamic

- LAN Network
 - IP[current setting] – select Dynamic or Fixed
 - DNS [current setting] – select Dynamic or Fixed

Date & Time

Set up and select options for time zone, clock and date formats, adjust for day light saving time, network time, NTP server address, DAB time and FM time.

Language

Select language

DAB Setup

Options to scan for available stations to create station list, manually search for stations and display station list

FM Setup

Options to select FM area, scan for FM stations to create station list and display station list

Local Radio (United States)

Option to automatically set local stations or set manually

Playback Setup

Options to repeat all, repeat one, shuffle or normal

Resume play options

play when ready or do not start playing

Power-on options

resume from last or go to Standby

Dimmer

options to set LCD brightness levels in play and Standby – set Dim and Bright light levels independently from dark to full brightness

EQ [current setting]

options for playback sound e.g. Flat, Rock, Classical

Buffer Time [current setting]

Select either a 2 or 5 second buffer (storage) of streaming information to be stored before restoring audio after short breaks in the Internet data stream.

Information

Network and System information

Software Update

Request an update to the system software. Do not turn off the radio until the update has completed. If an error occurs or radio becomes unresponsive, please use the power switch at the rear to restart the radio.

Reset to default

reset all the Radio Tuner settings and options back to the exit factory condition

Browse / Search

On the opening page click Browse / Search at the lower right side of the page.

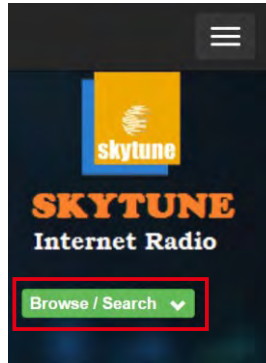

Enter the name of a Radio Station or Browse the structured list of stations available, select the one of interest and click on the heart symbol (♥) when the station logo is displayed.

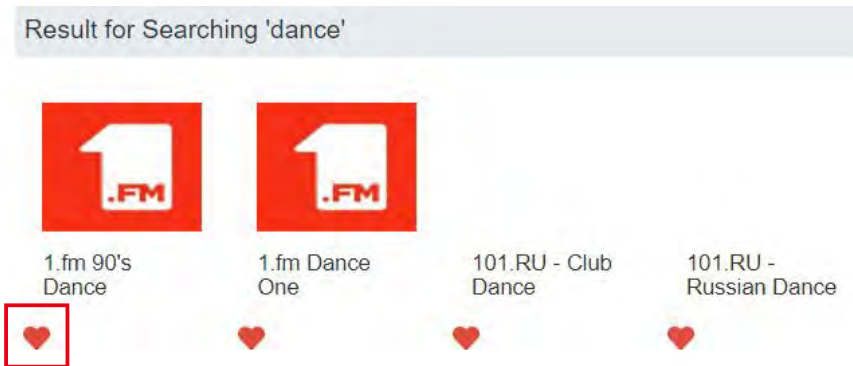

The Radio Tuner connection page will ask if the station is to be played or saved in your My Favorite list.

To make an Internet connection to the Radio Tuner it's IP address must be entered in the space provided – the Radio Tuner IP can be found at Configuration > Information > Network Information.

Add Favourite / Listen to Station ✕

Which operation do you want to apply to the station ?

1.fm Dance One

Add station to my radio device favourite

Listen to station on my radio device

Please enter your radio device's IP below.

192 . 168 . 1 . 11

Once the IP address has been entered make selection to save or listen, click Send.

The Radio Tuner's My Favorite page will be displayed with your list of Preset stations that can be edited using the tools provided on the web page.

Request to add Radio Station

If you know the name of a Radio Station but it is not in the list a request can be made to have it added.

On the opening page select the Suggest Station tab and fill in the application.

Adding a Radio Station

To add a Radio Station its name and URL can be entered in the Add Channel section along with selecting the Country where it is located and Genre of audio entertainment it provides.

MY FAVOURITE

Channel Group : BOOT

	Channel Name	URL	
1.	DJ AAM Radio FM	*****	Edit Delete Top Up Down Bottom
2.	Country Radio Switzerlar	*****	Edit Delete Top Up Down Bottom
3.	Bigbeat	*****	Edit Delete Top Up Down Bottom
4.	24Radio Switzerland	*****	Edit Delete Top Up Down Bottom
5.	AFN American Freedom	*****	Edit Delete Top Up Down Bottom
6.	Energy Berlin	http://energyradio.de/bremen	Edit Delete Top Up Down Bottom
7.	MP3 Pro	http://www.katrafm.com/katrafm_mp3pro.m3u	Edit Delete Top Up Down Bottom
8.	2	http://www.ultranet.biz/vegasandanski.m3u	Edit Delete Top Up Down Bottom
9.	stream 2	http://lindowsradio.com:8600/listen.pls	Edit Delete Top Up Down Bottom
10.	aac 128	http://eastlondonradio.com:8100/bighigh.aac	Edit Delete Top Up Down Bottom
11.	Seoul Shoutcast	http://yp.shoutcast.com/sbin/tunein-station	Edit Delete Top Up Down Bottom

Add Channel

Channel Name	URL
<input style="width: 95%;" type="text"/>	<input style="width: 95%;" type="text"/>
<input type="Submit"/> <input type="Reset"/>	

Smart Phone, Tablet or Computer Control

With device connected to the same Wi-Fi network as the Radio Tuner use web browser to edit lists and add radio stations.

Enter the Radio Tuners IP address (Configuration > Information > Network to find IP address) as web address and a window will open to edit lists e.g. add your favorite radio station URL if it is not in the list .

Cannot connect to the Wi-Fi Network**a) Common Causes**

- Rear panel Wi-Fi Network Antenna not in vertical position.
- Incorrect passcode / password for the selected Network.
- Location of the Radio Tuner has a weak Wi-Fi signal – if possible check with another Wi-Fi connected device in the same location.

b) Unusual Causes

- Rear panel Wi-Fi Network Antenna is completely surrounded by metal objects
- Incorrect Network security encryption – Radio Tuner supports WEP, WPA and WPA 2

Cannot connect to wired LAN

- DHCP server not available or DHCP is disabled or DHCP server does not have access to the Internet.
- Firewall on DHCP server blocking port – Radio Tuner at a minimum needs UDP, TCP and DNS ports 80, 443, 8008 and 53.
- Radio Tuner MAC address is being blocked by the Router – make sure the MAC address is in the Router allowed equipment list. Find the Radio Tuner MAC address Configuration>Information>Network Information.

Cannot play UPnP or DLNA Files

- There is no UPnP or DLNA server.
- The UPnP server is not streaming files over the Wi-Fi Network.
- The server is not correctly configured to allow sharing of files over the network

Internet Radio has interruptions (drop outs)

- Wi-Fi Channel – incorrect region selected
Configuration>Network>Wi-Fi Channels.
- Weak Wi-Fi signal – check the Wi-Fi symbol (top left hand side of

LCD display) for a minimum of two “Bars” - add a Wi-Fi Extender to the Network if necessary.

- Radio Station has interrupted streaming – check by trying a stations in the Skytune> Globe Most Popular list.
- The Internet connection does not have sufficient bandwidth (capacity) to support all the devices connected to the Network when operating at the same time or is experiencing excessive error rates – have the Internet connection checked by the ISP (Internet Service Provider).

Internet Radio cannot play some stations

- The station may not be streaming – not all stations stream for 24 hours a day.
- There are too many users at this time – some stations have a limited number of users they can support at any given time.
- The station link is out of date – it is updated daily and should be correct the next day.
- The station link is no longer active – the station is no longer available.

DAB/DAB+ or FM Radio has poor reception

- The wire antenna not properly installed – make sure it is connected securely, pulled out to its full length and not attached to metal objects.
- Weak radio signal in this location – the closer to windows the stronger the signal will be but this is often not a practical solution and it might be necessary to use a more efficient (higher gain) or externally mounted antenna.

Radio Tuner plays but there is no sound or it has poor sound quality / is distorted

- If they are available check the sound with headphones connected to the Radio Tuner – the **Tune/Select** knob controls the volume.

- Make sure that the Radio Tuner audio output is connected to the power amplifier and this connection is selected as the amplifier input / source e.g. if the CD connectors are used select CD.
- The Radio Tuner is connected to the “Phono” / Record Player input connector – this input cannot be used as it is a special input designed to work with record players.

A/C Adaptor Power Input: 100 – 240 Volts 50/60 Hz 0.2 Amp.
DC Power Input: 5 Volts 1 Amp.
Remote Controller: 2 x AA Battery

Wi-Fi Wireless Network: IEEE 802.11b/g/n (5 GHz only version ac –
not supported)
Frequency: 2.4 GHz
Security: WEP, WPA, WPA2

Ethernet (Wired LAN): 10 Mbps (RJ45)

Bluetooth Version: V4.2 BR, EDR Compliant
Frequency: 2.4 GHz
Range: 32 Feet (10 meters) Line of sight
Transmit Power: 0 dBm Receive only (not for headphones)

FM Radio Frequency: 87.5 – 108 MHz
DAB+/DAB: 174.928MHz(5A)- 239.200MHz(13F)
Not available in USA or Canada

Audio File Streaming Formats

UPnP: MP3, AAC, AAC+, WAV, FLAC
DLNA: MP3, AAC, AAC+

Audio Outputs: 2 Digital 2 Analogue

Digital: TOSLINK & Co-axial (SPDIF)
Analogue: RCA Left & Right, Standard ¼ Headphone

External Antenna: Wi-Fi Fixed, FM Radio Wire (supplied)

Dimension: 17" x 11" x 2.5" (430 x 243 x 48 mm)
Weight: 5.6 Lbs (2.5 Kgms)

Remark: Specification may vary without notice

In the box

- * Internet Radio Tuner
- * Power adaptor
- * Wire antenna
- * Remote control (without batteries)
- * User manual

WEEE and Recycling

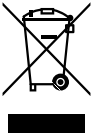

The European laws do not allow any more the disposal of old or defective electric or electronic devices with the household waste. Return your product to a municipal collection point for recycling to dispose of it. This system is financed by the industry and ensures environmentally responsible disposal and the recycling of valuable raw materials.

Ocean Digital Technology Ltd.
Flat B, 12/F., Yeung Yiu Chung (No.8) Ind. Bldg.,
20 Wang Hoi Road, Kowloon Bay,
Hong Kong
Email: support@oceandigital.com.hk

FCC

This equipment has been tested and found to comply with the limits for a Class B digital device, pursuant to part 15 of the FCC Rules. These limits are designed to provide reasonable protection against harmful interference in a residential installation. This equipment generates, uses and can radiate radio frequency energy and, if not installed and used in accordance with the instructions, may cause harmful interference to radio communications. However, there is no guarantee that interference will not occur in a particular installation. If this equipment does cause harmful interference to radio or television reception, which can be determined by turning the equipment off and on, the user is encouraged to try to correct the interference by one or more of the following measures:

- Reorient or relocate the receiving antenna.
- Increase the separation between the equipment and receiver.
- Connect the equipment into an outlet on a circuit different from that to which the receiver is connected.
- Consult the dealer or an experienced radio/TV technician for help.

Caution: Any changes or modifications to this device not explicitly approved by manufacturer could void your authority to operate this equipment.

This device complies with part 15 of the FCC Rules. Operation is subject to the following two conditions: (1) This device may not cause harmful interference, and (2) this device must accept any interference received, including interference that may cause undesired operation.

This equipment complies with the FCC RF radiation exposure limits set forth for an uncontrolled environment. This equipment should be installed and operated with a minimum distance of 20cm between the radiator and any part of your body.