

MODEL No:

WR15/1.85-K-V

NOTE: information herein is believed by Gwave to be accurate. However, Gwave assumes no responsibility for any omissions or errors inaccuracies for its use or for any infringements of patents or other rights of third parties that may result from its use. Data is intended for informational purpose only and does not constitute a contract of sale or any express or implied warranty, including any warranty of merchant ability or fitness for a particular purpose.

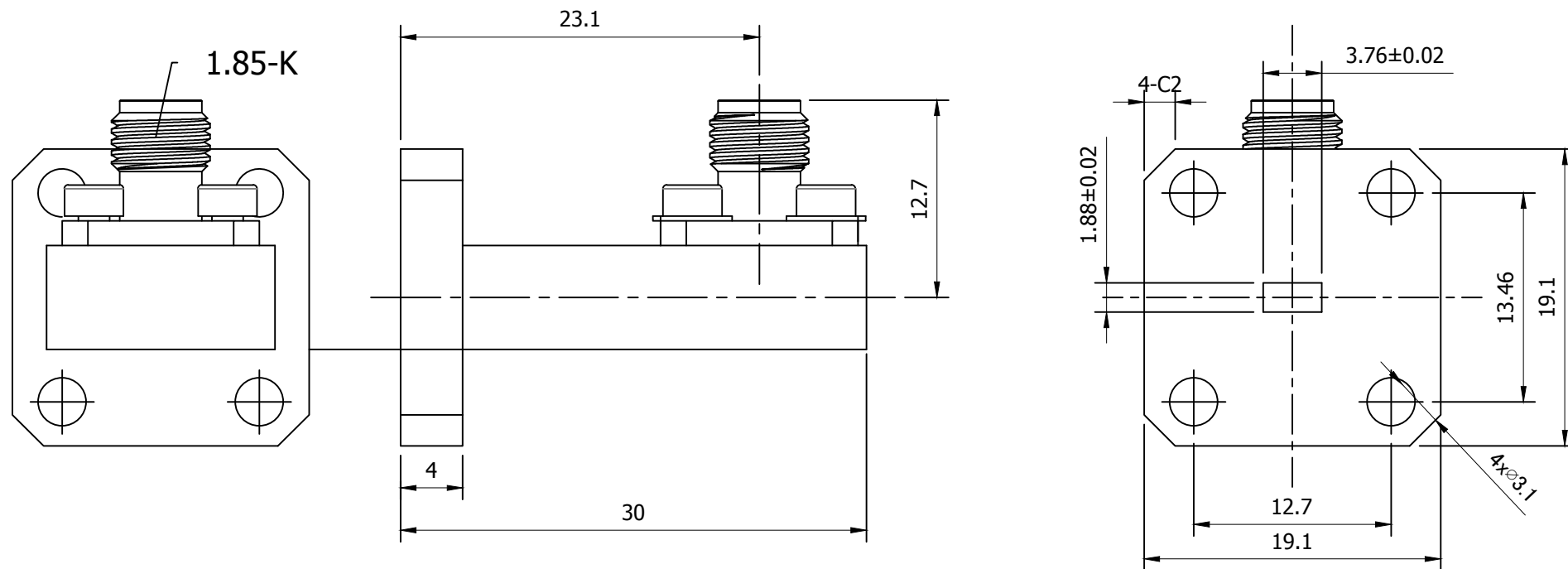

Connector Type	1.85mm Female
Connector Impedance	50 Ohm
Connector Polarity	Standard
Waveguide Type	WR15
Flange	
Adapter Body Style	Right Angle

Frequency	50 to 67 GHz
Insertion Loss (dB)	≤0.4
VSWR /Return Loss	≤1.4

BODY	AL
ITEM	MATERIAL&FINISH

Temperature Range	-40°C to +105°C
2002/95/EC(RoHS)	Compliant

1. ALL DIMENSIONS ARE IN MM. ALL ANGLES ARE IN DEGREES.

NOTES: UNLESS OTHERWISE SPECIFIED.

REV A	PROTOTYPE RELEASE	REV BY:	DATE:	APRVD:	DATE:
----------	----------------------	---------	-------	--------	-------

TITLE:

Gwave

WR15/1.85-K-V
WAVEGUIDE TO COAX ADAPTOR

DRN BY:	DATE:	DWG NO.	REV. A
SHEET: 1 OF 1			