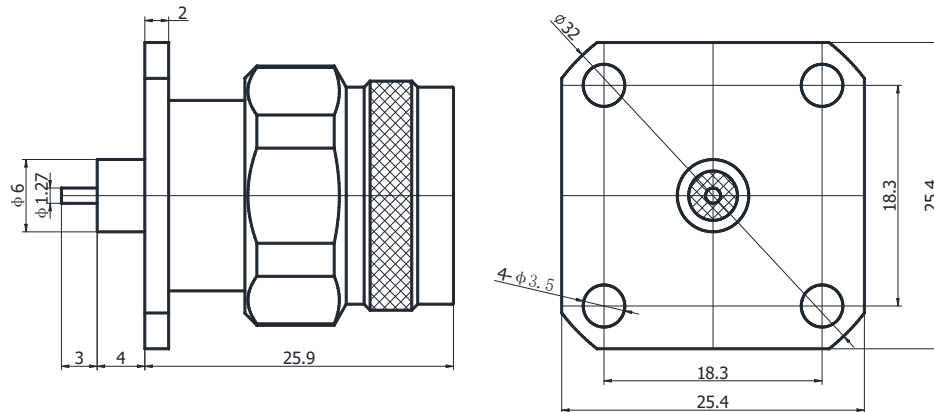

N(MALE) FOR PCB

N-JFD30

*Dimensions are in mm

Configuration

Connector 1 Type	N Male
Connector 1 Impedance	50 Ohms
Connector 1 Polarity	Standard
Body Style	Straight
Connector Mount Method	4 Hole Flange
Connector 2 Interface Type	Pin
Attachment Method	Solder

Electrical Specifications

Frequency	DC to 18 GHz
Insertion Loss (dB)	$\leq 0.05 \times \text{Sqrt.}(f_GHz)$
Return loss/VSWR	1.25

Materials Information

Centre Contact	CuBe Gold Plated
Outer Contact	Stainless Steel
Body	Stainless Steel
Dielectric	PTFE&PEI

Environmental Data

Temperature Range	-40°C to +165°C
2002/95/EC(RoHS)	Compliant

While the information has been carefully compiled to the best of our knowledge, nothing is intended as representation or warranty of our part and no statement herein shall be construed as recommendation to infringe existing patents. In the effort to improve our products, we reserve the right to make changes judged to be necessary.