



E-BIKE USER MANUAL

ATTENTION

Please read this manual carefully before using the BEZIOR electric bicycle. If you do not understand this information, or if you do not cover the issues covered in this manual, please contact the dealer.



Thanks for using BEZIOR

THANK YOU FOR CHOOSING BEZIOR E-BIKES

Welcome to your new BEZIOR E-Bike! You are entering a new world of ease, luxury, and mobility. Whether you're looking for an environmentally friendly alternative to your regular gas-powered vehicle, a fun way to avoid traffic congestion, or simply want to spend more time outdoors, we hope you enjoy your new E-Bike. In a life full of headwinds and tailwinds, it is our honor to be the wind at your back.

If you have questions or comments, please don't hesitate to contact us:

Email: support@beziior.com

web: www.beziior.com

VEHICLE IDENTIFICATION NUMBER / SERIAL NUMBER

FOR YOUR RECORDS

For future reference, please fill in the important information below. Your serial number can be found on the inward-facing surface of the frame seat stay or on head top tube.

Please retain your sales receipt for any possible warranty or loss claims.

MY BEZIOR SERIAL NUMBER:



FOR YOUR RECORDS

MY BEZIOR E-BIKE

Name

Address

Purchase Date

Purchase Channel

BEZIOR WEBSITE **AMAZON** **EBAY** **OTHER**

Model

Color

Serial #

BEZIOR E-BIKES

TABLE OF CONTENTS

ABOUT THIS MANUAL	06
IMPORTANT SAFETY INFORMATION	07
OPERATIONAL INSTRUCTIONS	09
ASSEMBLY INSTRUCTIONS	15
RECHARGING THE BATTERY	21
BATTERY AND CHARGER CARE	23
GEARS	24
LED DISPLAY & KEYS	25
BRAKES	26
TIRES & INNER TUBES	27
TROUBLESHOOTING	28
BEZIOR E-BIKES FAQs	29
INSPECTION AND MAINTENANCE	31
WARRANTY	33

01 ABOUT THIS MANUAL

This manual was written to help you get the most performance, comfort, enjoyment, and safety when riding your new BEZIOR E-Bike. The manual describes specific care and maintenance procedures that help protect your warranty and ensure years of trouble-free use. Please pay particular attention to the section on battery charging and maintenance.

It is important for you to understand your new BEZIOR

E-Bike, its features, and its operation, so you get maximum enjoyment with maximum safety. By reading this manual before you go out on your first ride, you'll know how to get the most from your new BEZIOR E-Bike.

It is also important that your first ride on a new BEZIOR E-Bike is taken in a controlled environment, away from cars, obstacles, and other cyclists.

02 IMPORTANT SAFETY INFORMATION

Cycling can be a hazardous activity even under the best of circumstances. Proper maintenance of your BEZIOR E-Bike is your responsibility, as it helps reduce the risk of injury. This manual contains many warnings about the consequences of failure to maintain or inspect your

BEZIOR E-Bike. Improper use could result in serious injury or death.

We recommend you use a trusted professional bike technician to assemble your BEZIORE-Bike.

IMPORTANT SAFETY INFORMATION

A. ALWAYS WEAR A HELMET

Helmets significantly reduce the number and severity of head injuries. Always wear a helmet that complies with your state laws when riding your BEZIOR E-Bike. Check with your local police department for requirements in your community. Make yourself more visible by wearing bright reflective clothing. Keep your reflectors clean and properly aligned. Use head and tail lights in reduced lighting conditions. Wear sturdy shoes and eye protection. Also check your state laws concerning other protective gear that may be required when riding your BEZIOR E-Bike.

B. KNOW YOUR BEZIOR E-BIKE

Your new BEZIOR E-Bike incorporates many features and functions that you may be unfamiliar with. Read this manual thoroughly to understand how those features enhance your riding pleasure and safety.

C. RIDE WITHIN YOUR LIMITS

Take it slow until you are familiar with the riding conditions, as traction can be greatly reduced and brakes become less effective. Never ride faster than conditions warrant or beyond your riding abilities. Remember that alcohol, drugs, fatigue, and inattention can significantly reduce your ability to make good judgments and ride safely.

D. KEEP YOUR E-BIKE IN SAFE CONDITION

For your safety and enjoyment, and to ensure a long life for your BEZIOR E-Bike, inspect and maintain your E-Bike regularly. Follow the inspection and maintenance guidelines throughout this manual. Check critical safety equipment before each and every ride.

COMPONENT OR CONDITION	INSPECT BEFORE EVERY RIDE	INSPECT PERIODICALLY*	CLEAN AND/OR LUBRICATE	ADJUST/TIGHTEN	REPAIR/REPLACE IF NECESSARY
Tire pressure (55-65 psi)	X			X	
Tire wear/damage	X			X	
Brake pad adjustment	X			X	
Wheel quick release adjustment	X				X
Head and tail lights	X				X
Controls and displays	X				
Seat post quick release adjustment	X			X	
Brake pad wear		X			X
Brake cable tension/wear		X		X	X
Spoke tension		X		X	
Wheel true		X		X	
Hub bearings		X	X	X	
Chain lubrication		X	X		
Derailleur adjustment		X	X	X	
Reflectors		X			X
Battery and charger		X			X
Headset adjustment		X	X	X	
Bottom bracket adjustment		X	X	X	
All bolts, nuts & mounting hardware		X		X	X

*Every 5 to 10 rides depending on length and conditions of ride.

03 OPERATIONAL INSTRUCTIONS



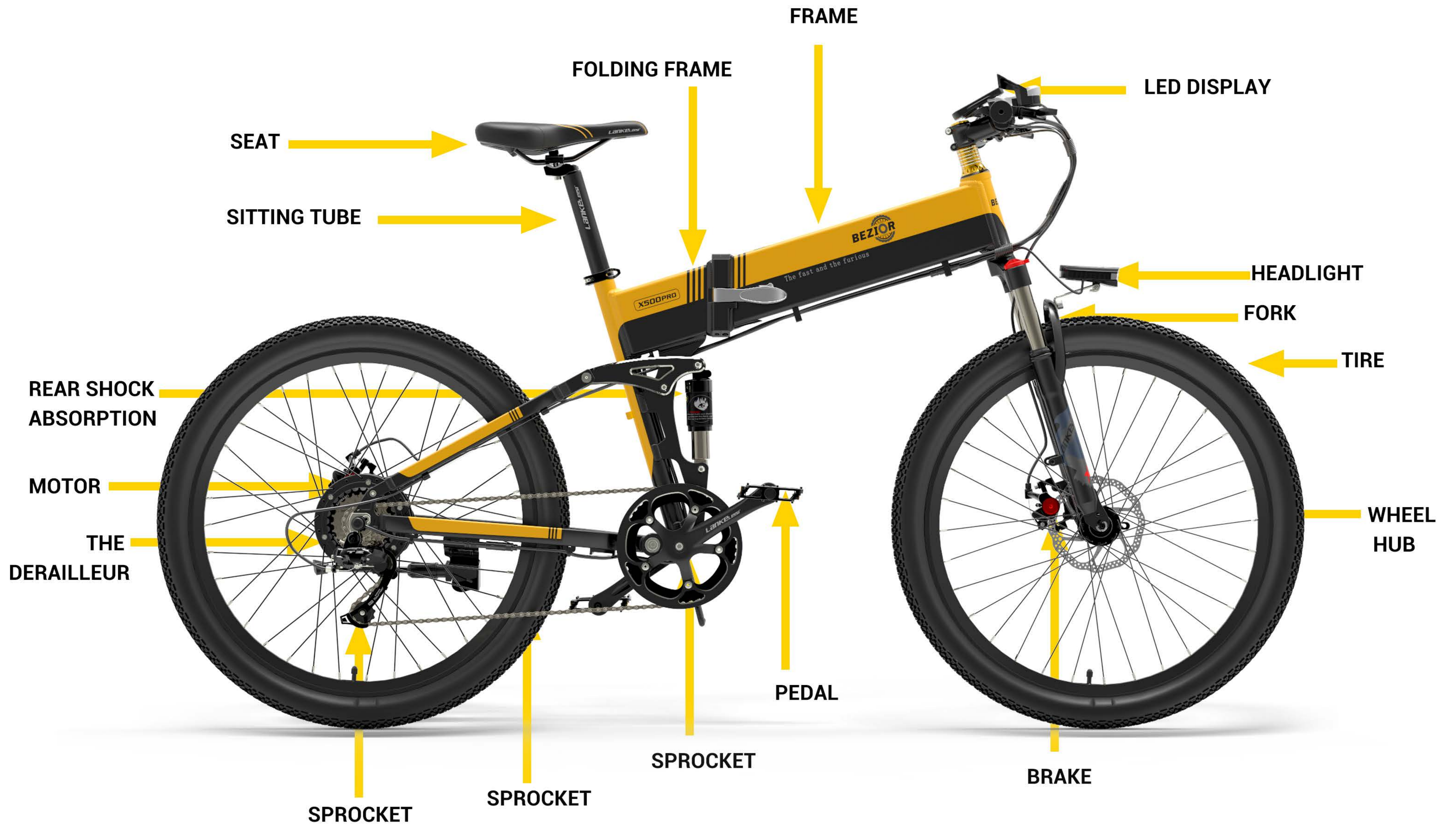

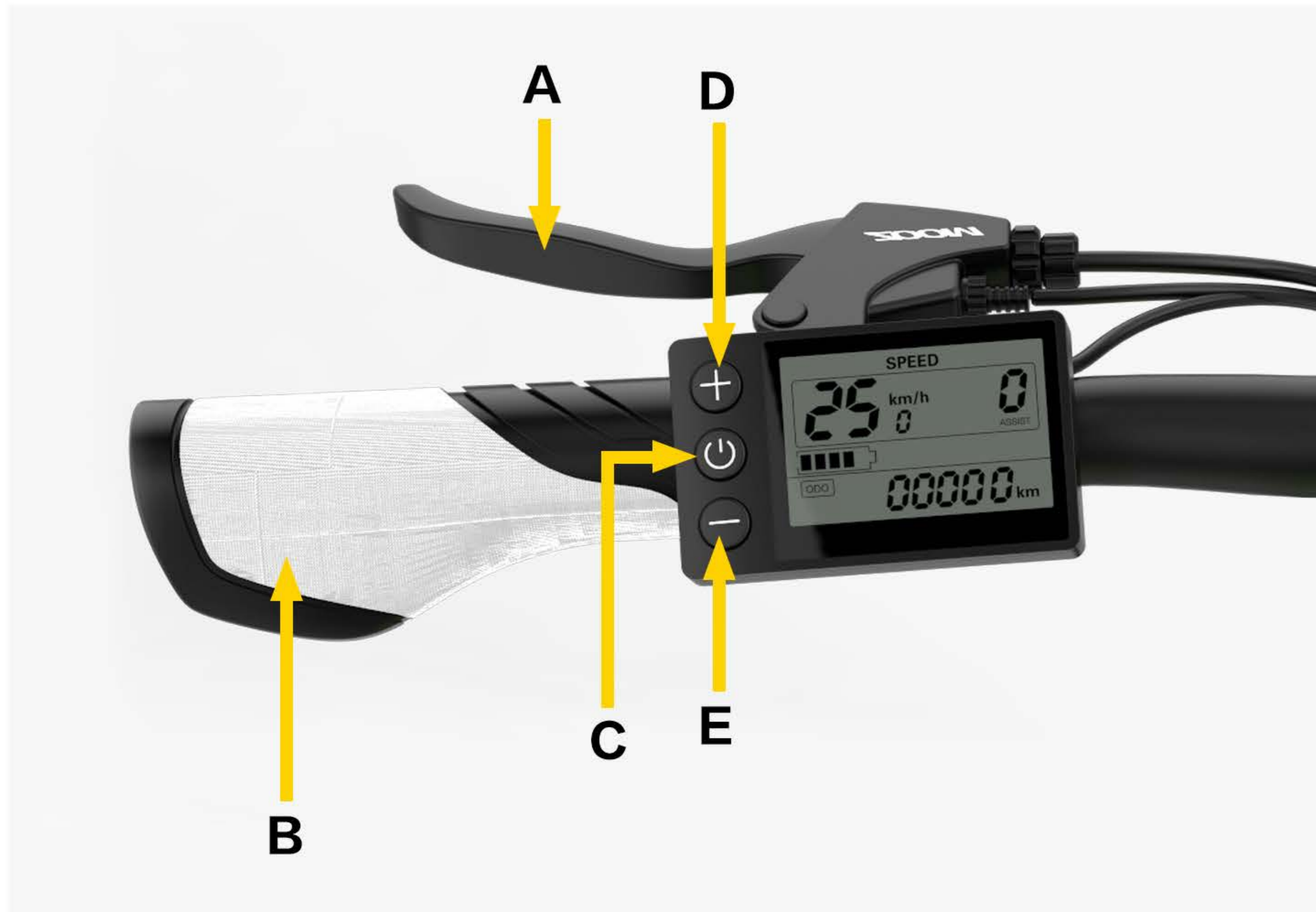

LEFT HANDLEBAR

APPLICABLE MODEL (X2000PUIS)

A

Rear Brake Lever (behind the handlebar grip in this photo). The rear brake is activated by squeezing the left brake lever. THIS IS THE OPPOSITE OF A TRADITIONAL BICYCLE.

B

Left Handlebar Grip

C

Power On/Off Button:

Press M for 3 seconds to power on or power off your BEZIOR E-Bike

D

Speed Increase/Headlight Button: Press "+" one time to increase speed

Press "+" for 3 seconds to turn on/off the headlight

E

Speed Decrease/Cruising Button: Press "-" one time to decrease speed

Press "-" for 3 seconds to turn on low speed cruise function (about 4MPH) while in PAS 0 mode.

To set a different cruising speed, twist the right handlebar throttle, setting the speed you want, then at the same time, press "-" for 3 seconds.

To cancel cruise function, squeeze right or left brake

RIGHT HANDLEBAR

(X2000PUIS)

A

Rear Derailleur Shifter — by pressing the button while pedaling, you can increase gears from 1 to 7. The shifter is labeled with the corresponding gear selection.

B

Rear Derailleur Shifter — by pressing the lever while pedaling, you can decrease gears from 7 to 1. The shifter is labeled with the corresponding gear selection.

C

Front Brake Lever (behind the handlebar grip in this photo). The front brake is activated by squeezing the right brake lever. THIS IS THE OPPOSITE OF A TRADITIONAL BICYCLE. gear selection.

D

Twist Throttle — Twist this grip to apply power to the motor.

E

Right Handlebar Grip

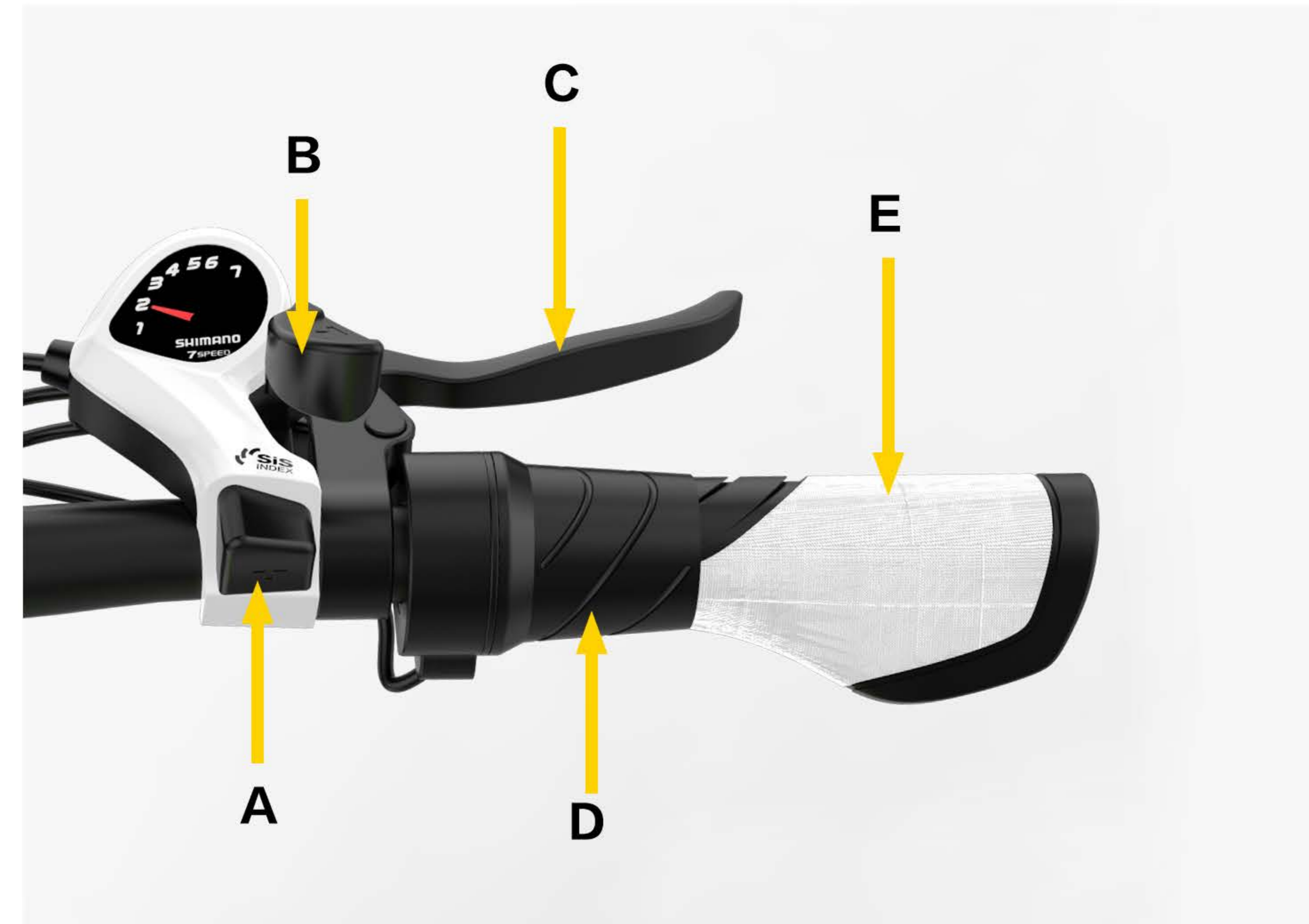

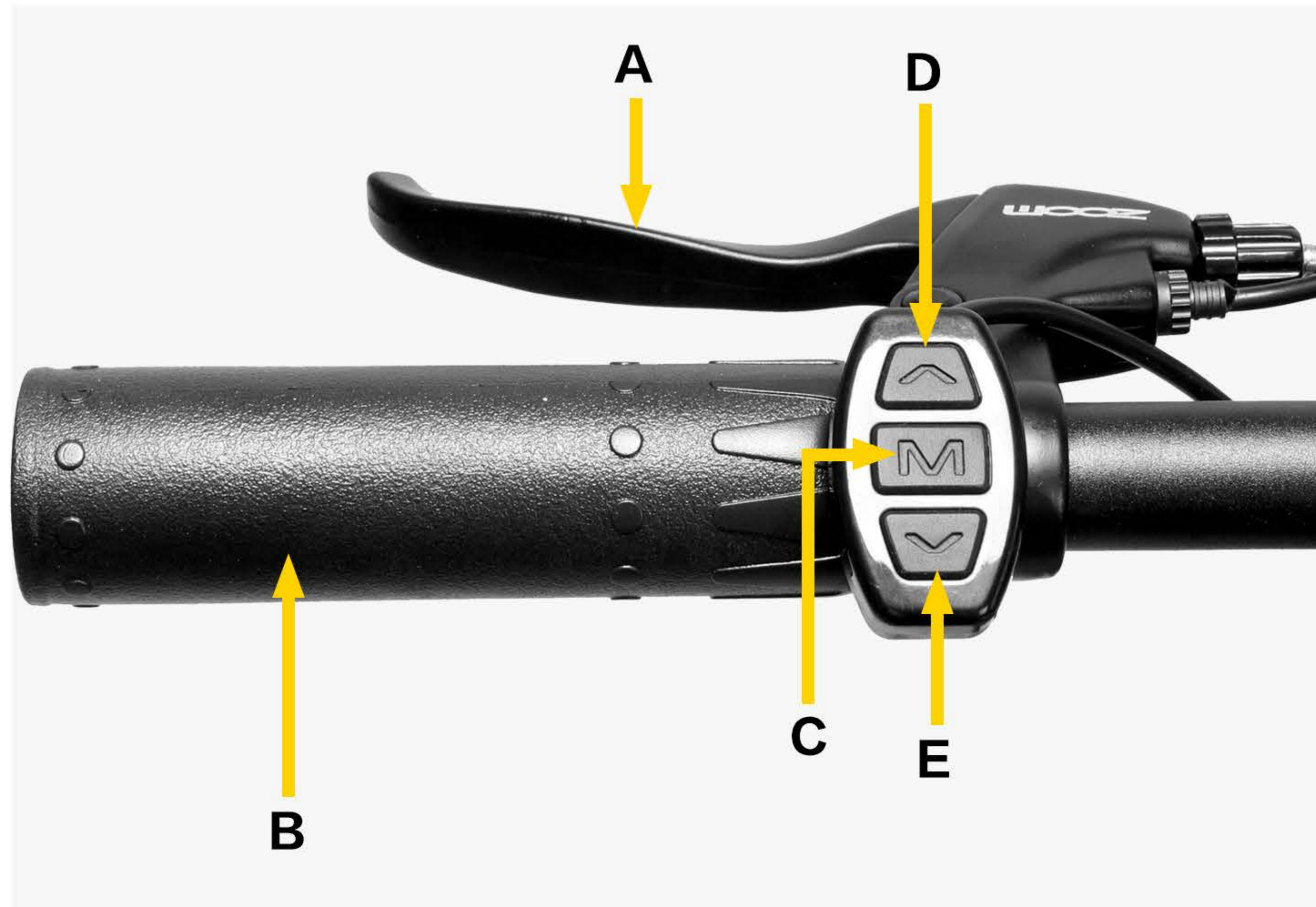

LEFT HANDLEBAR

APPLICABLE MODEL (X1000, X500PRO)

A

Rear Brake Lever (behind the handlebar grip in this photo). The rear brake is activated by squeezing the left brake lever. THIS IS THE OPPOSITE OF A TRADITIONAL BICYCLE.

B

Left Handlebar Grip

C

Power On/Off Button:
Press M for 3 seconds to power on or power off your BEZIOR E-Bike

D

Speed Increase/Headlight Button: Press ▲ one time to increase speed
Press ▲ for 3 seconds to turn on/off the headlight

E

Speed Decrease/Cruising Button: Press ▼ one time to decrease speed
Press ▼ for 3 seconds to turn on low speed cruise function (about 4MPH) while in PAS 0 mode.
To set a different cruising speed, twist the right handlebar throttle, setting the speed you want, then at the same time, press ▼ for 3 seconds.
To cancel cruise function, squeeze right or left brake.

RIGHT HANDLEBAR

APPLICABLE MODEL (X1000, X500PRO)

A

Rear Derailleur Shifter — by pressing the button while pedaling, you can increase gears from 1 to 7. The shifter is labeled with the corresponding gear selection.

B

Rear Derailleur Shifter — by pressing the lever while pedaling, you can decrease gears from 7 to 1. The shifter is labeled with the corresponding gear selection.

C

Front Brake Lever (behind the handlebar grip in this photo). The front brake is activated by squeezing the right brake lever. THIS IS THE OPPOSITE OF A TRADITIONAL BICYCLE.

D

Twist Throttle — Twist this grip to apply power to the motor.

E

Right Handlebar Grip

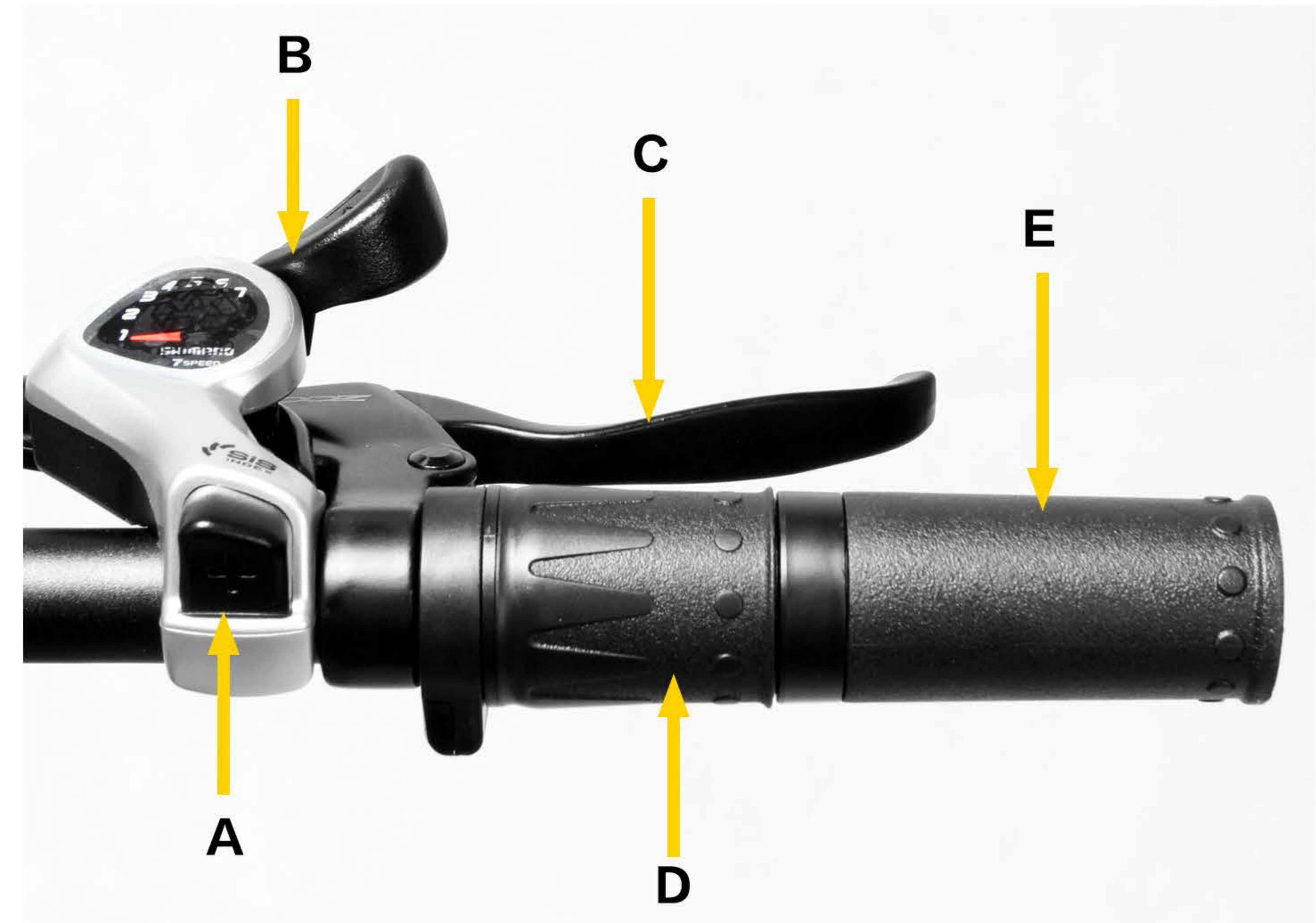

04 ASSEMBLY INSTRUCTIONS



PART 1: REMOVE PACKAGING



01
Unpack your BEZIOR electric bike.



02
Gather necessary tools.



03
Remove packing materials.



04
Remove front wheel.

PART 2: HANDLEBAR ASSEMBLY

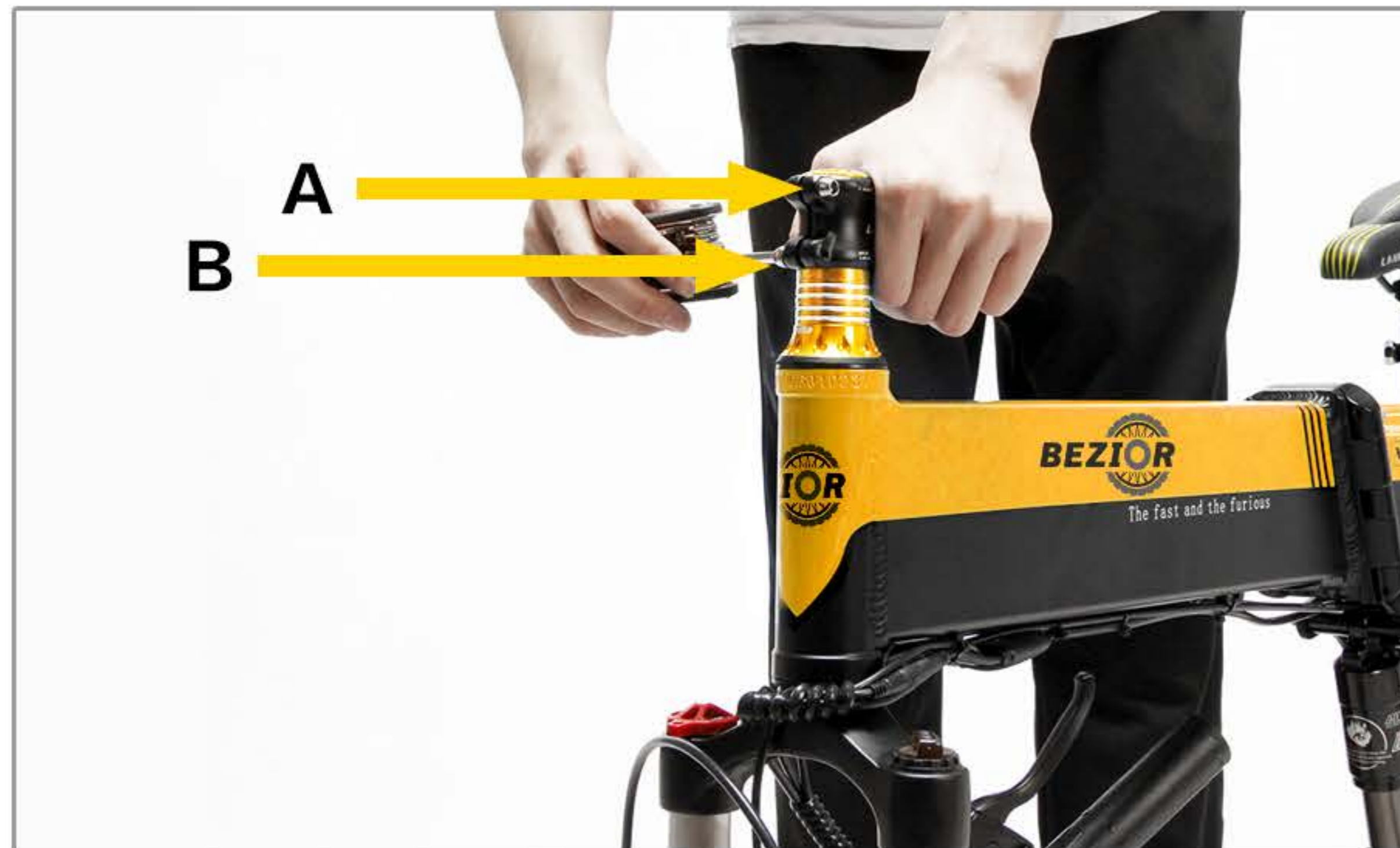

01

Loosen the riser sides A, B screws

*Before installation, pay attention to the front and rear brakes always on the same side



02

Fix the front shock absorber and rotate the riser 180°

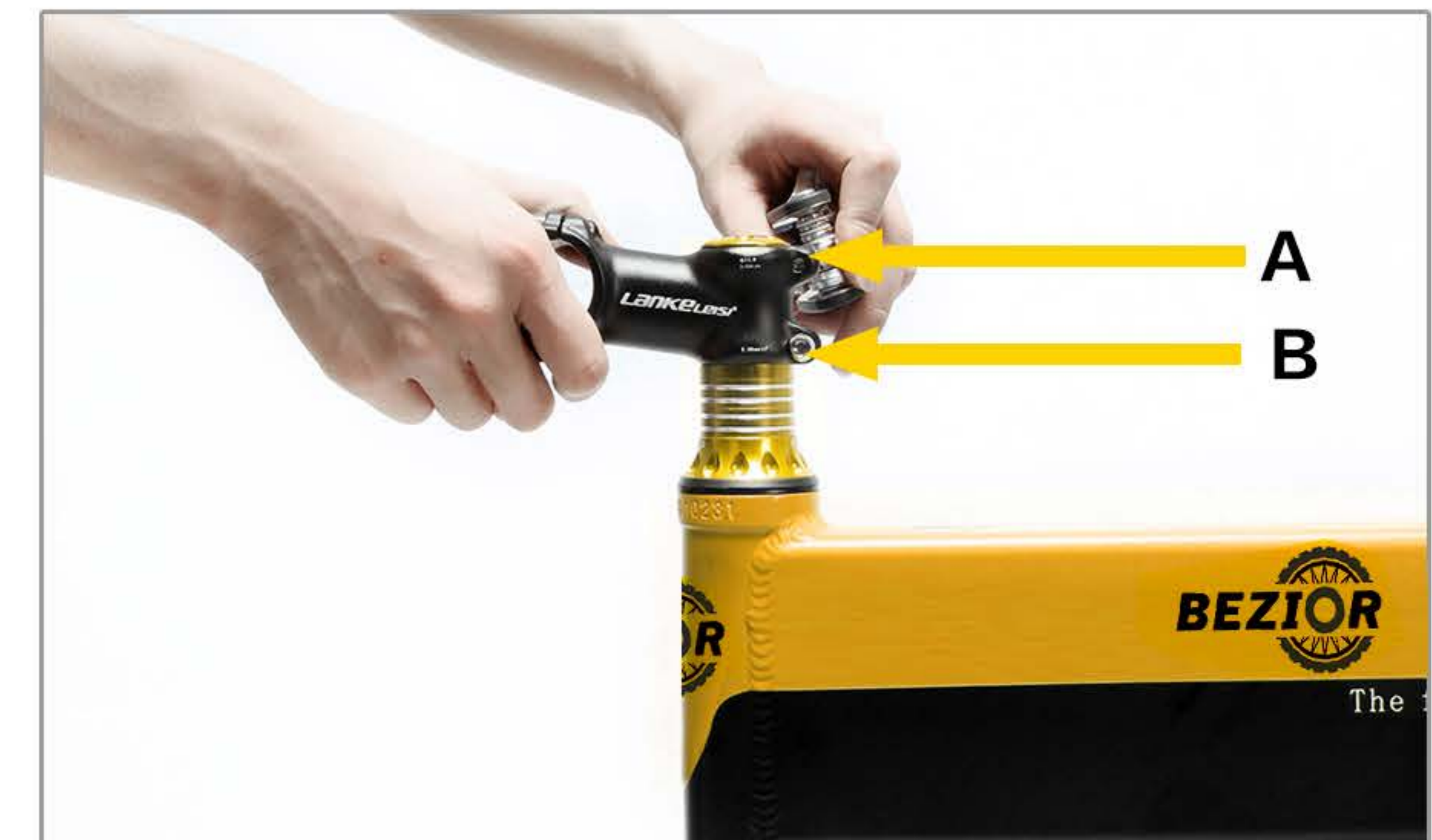

03

Tighten the side A, B screws

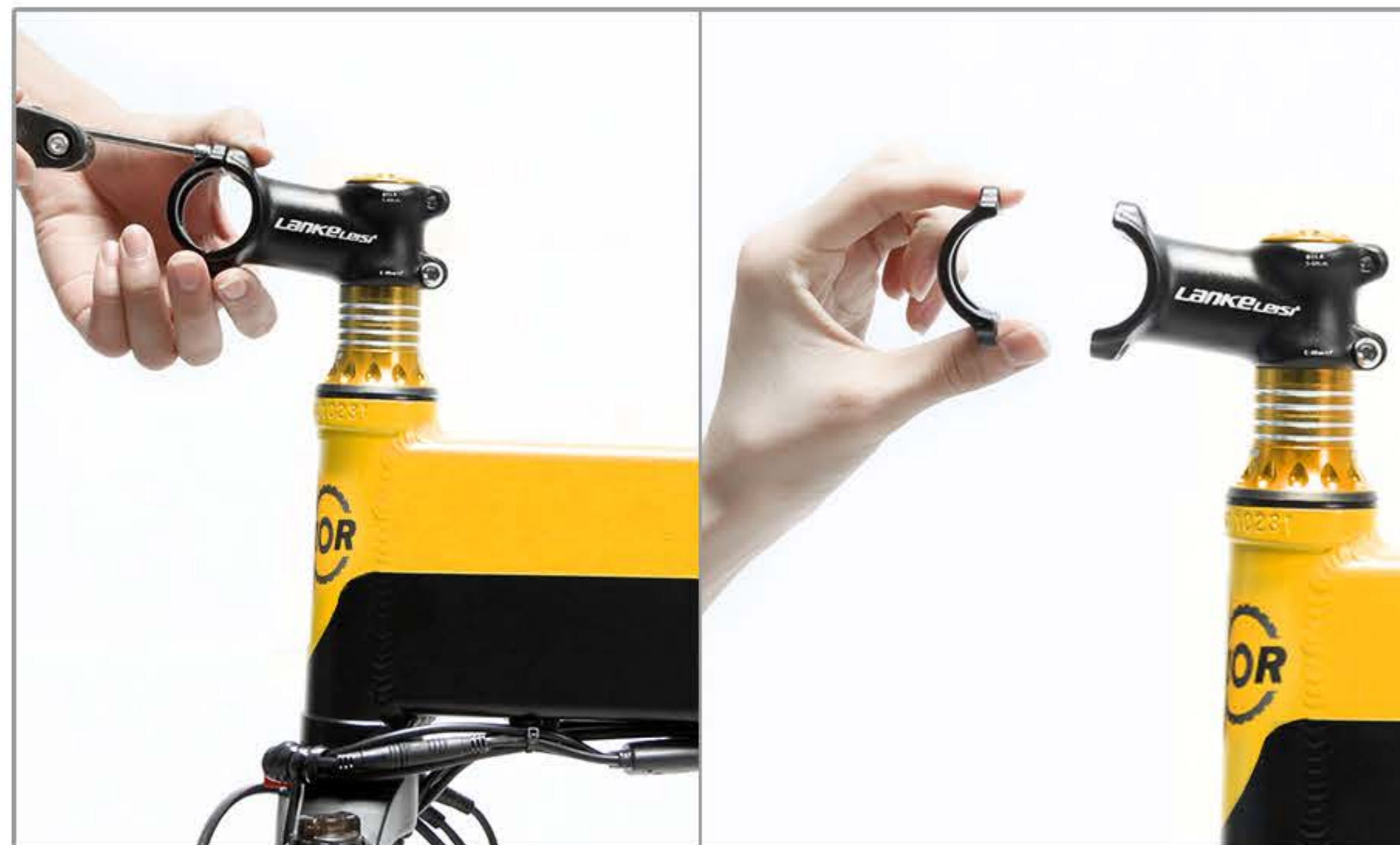

04

Remove front 4 bolts from stem cover, then remove stem cover.



05

Mount handlebar onto stem, then replace stem cover and tighten all 4 bolts.



06

Adjust handlebar according to your needs, then ensure all bolts are tightened firmly.

PART 3: HEADLIGHT & FRONT WHEEL ASSEMBLY



01

Remove the bolt from the headlights, then adjust the headlights and front bezel to the correct position and tighten the bolts.



02

Turn the bike upside down.
Adjust the height of the seat and rotate the angle of the dashboard to avoid direct contact with the ground



03

Remove the fork protector.
A: The protective shaft can be removed and thrown away



04

Put the wheel in the front fork
Disc brake disc alignment clamp card slot



05

Insert the front wheel for quick release.
A: Adjust the screw pressure,



06

Lock front wheel quick release.
Quick release installation is complete.

PART 4: PEDAL AND SADDLE MOUNTING&DIRECTION ADJUSTMENT



01

Determine the left and right pedals.
 "L" means the left side is mounted on the crank
 "R" means the right side is mounted on the chainring



02

"L" pedal is fixed counterclockwise to the crank

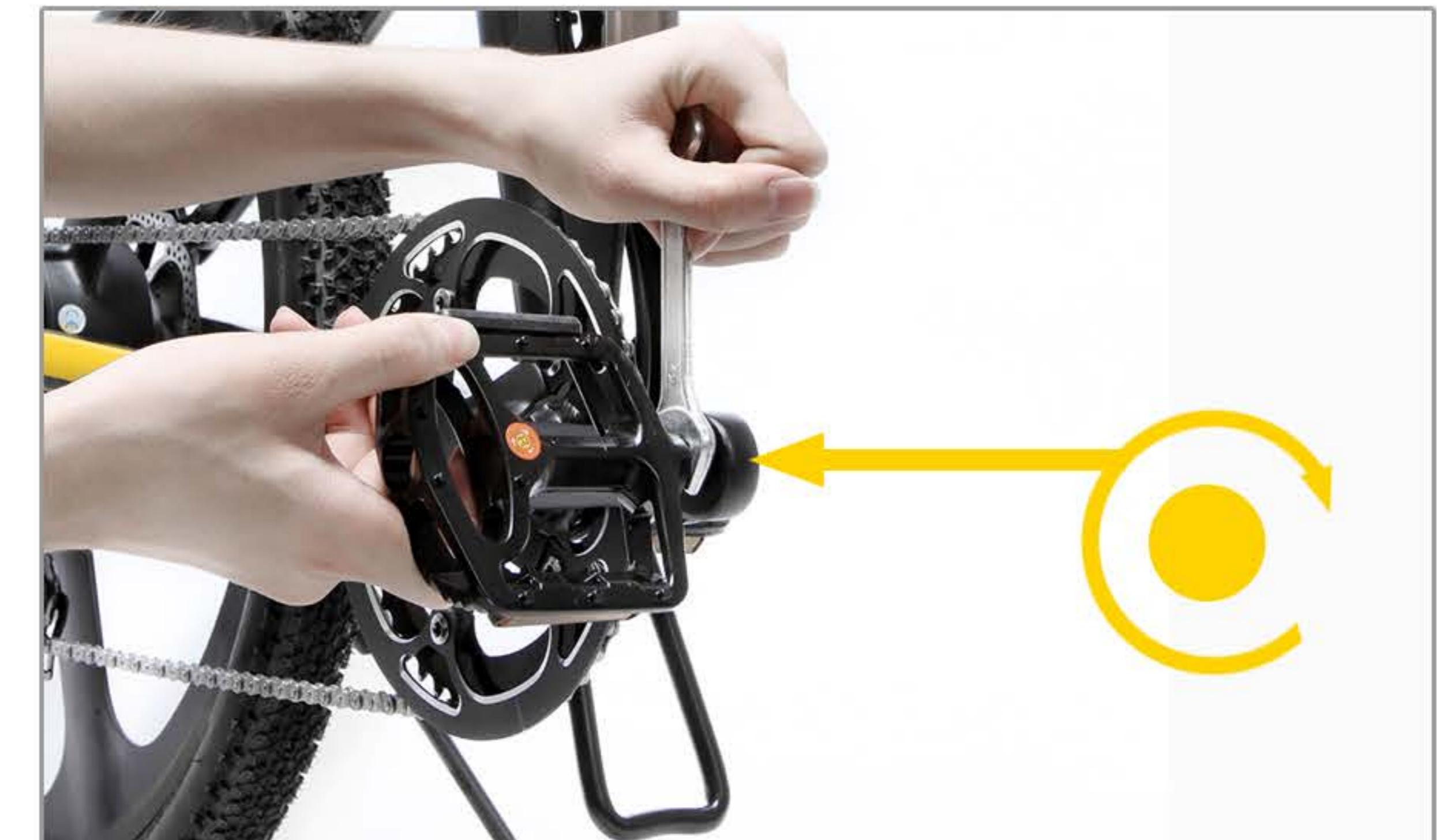

03

"R" pedal is fixed clockwise and fixed on the chainring



04

Adjust seat post according to your height, making sure it's within the safety line.



05

Fasten saddle clamp.



06

Stand in front of the wheel and face the wheel and handlebar at the "T" angle. And relock the screw

PART 5: FOLDING THE FRAME & REMOVING THE BATTERY



01
The folding insurance pushes forward while pulling the folding clasp.
A: Self-locking safety switch

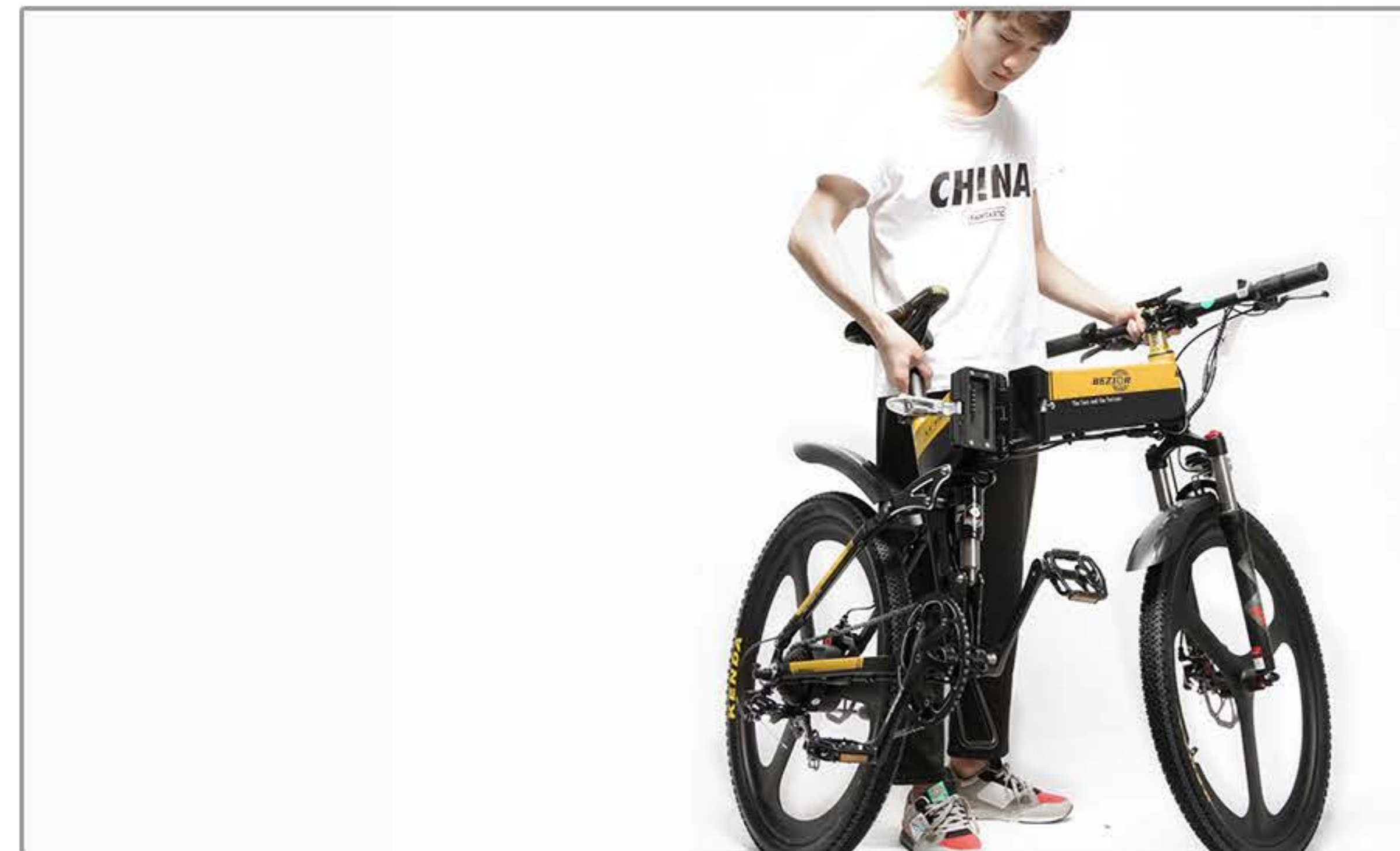

02
Release the switch and fold the bike in half



03
When opening the lock, please note that the lock cylinder has been fully retracted, then pull the key

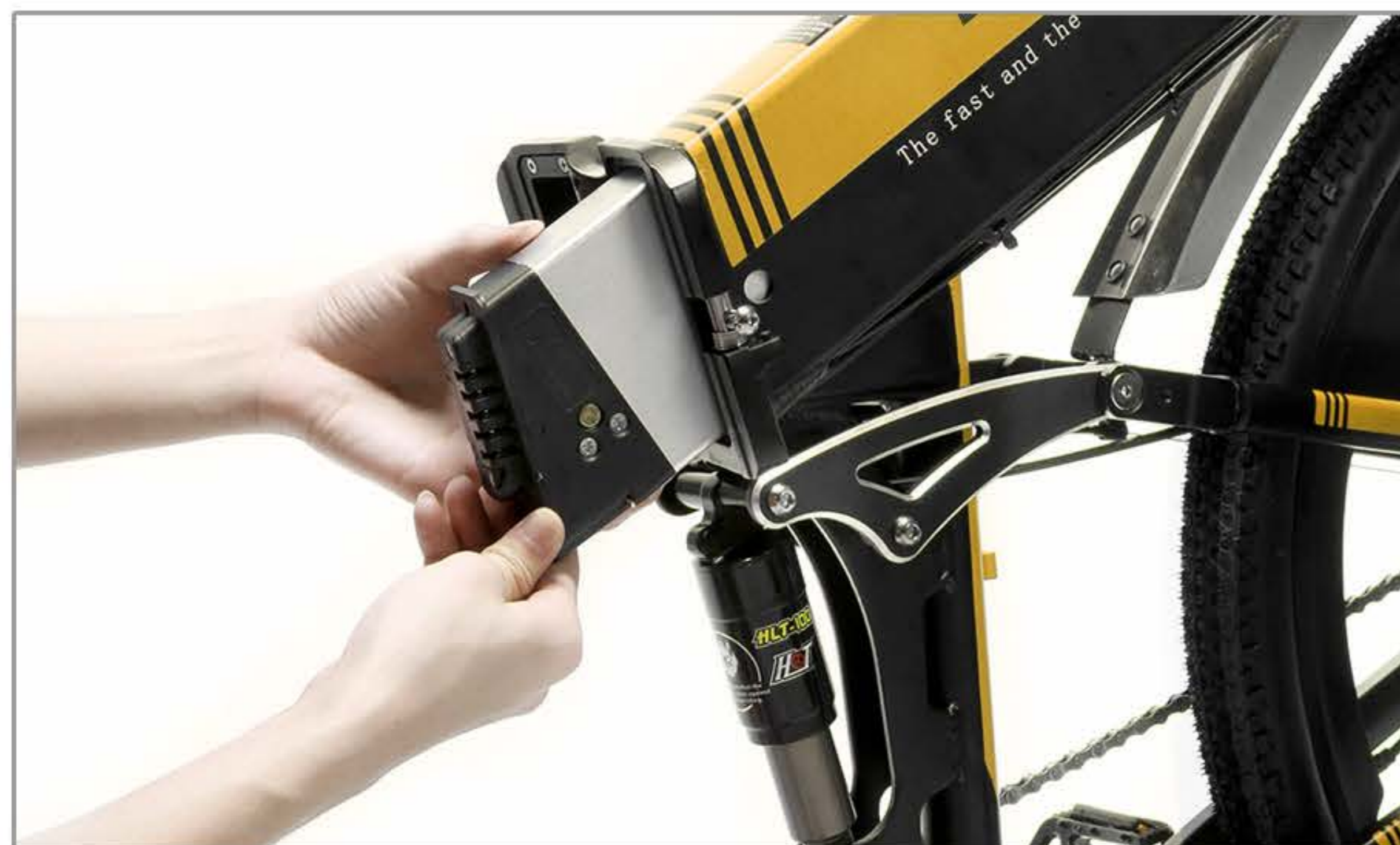

04
Easily remove the battery

05 RECHARGING THE BATTERY



A. Recharge the battery on E-Bike directly

OR



B. Remove battery from the E-Bike and recharge separately

RECHARGING THE BATTERY

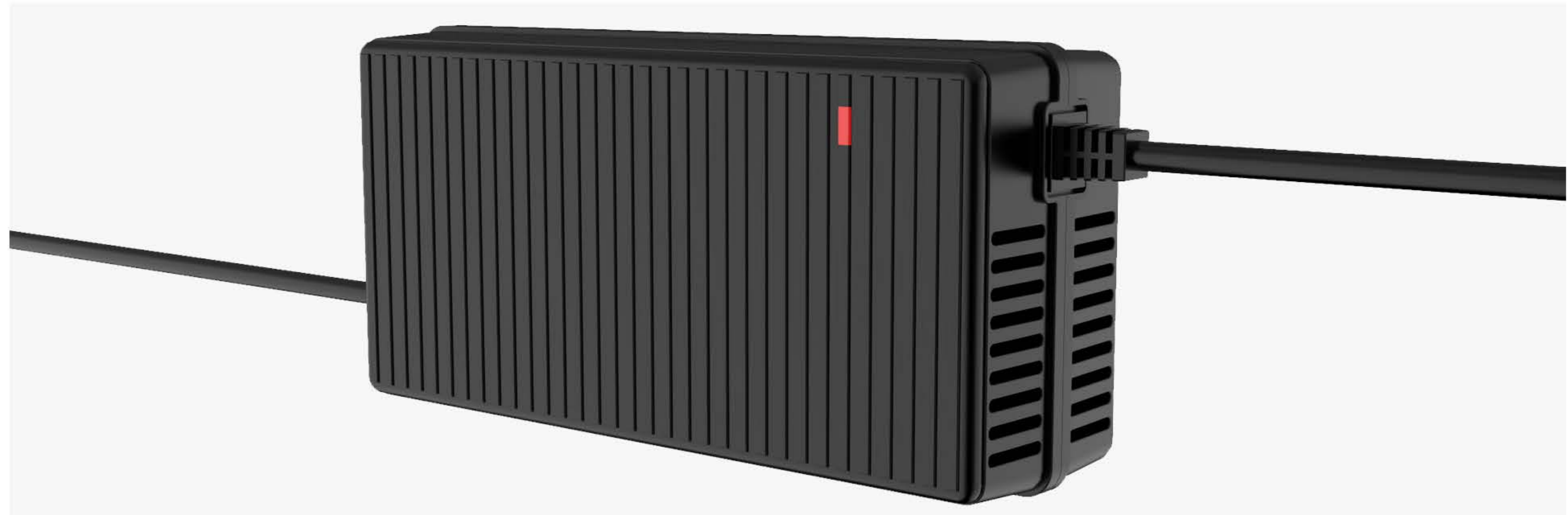

ATTENTION

Connect the battery first, then connect the power supply and make sure the red LED of the charger is lit. The charger will charge the completed battery within 3 to 7 hours.

A red light indicates that the battery is charging. A green light indicates that the battery is fully charged.

06 BATTERY & CHARGER CARE

If the battery will not be used for an extended period of time, charge it fully and recharge it every 2 months.

Store in a cool, dry place. Recharge the battery before it becomes completely discharged.

Do not use it to power other electrical devices. Improper use of the battery will damage the battery and shorten its useful life and may cause fire or an explosion. If you experience unusual sounds or odors coming from the charger or the battery, unplug charger immediately and contact BEZIOR customer service

Recharge battery after every use.

Do not disassemble or alter the battery or battery charger. Do not place the battery near fire or corrosive substances. Do not allow any liquids on or inside the battery/charger. Do not expose the battery/charger to extreme weather conditions.

Do not operate the battery/charger if damaged. Recharge the battery only with a charger specified by the manufacturer.

Do not use the battery/charger for any use other than its intended purpose.

07 GEARS

Your BEZIOR E-Bike is equipped with multiple speeds. The first gear is for easier and uphill pedaling, and the last gear is for maximum speed on level or downhill terrain. Change gears only while pedaling. The rear wheel contains seven or nine chain sprockets (depending on model). When the chain is around the largest sprocket, you are in 1st gear, or the lowest gear. The high gear will have the derailleur positioned so that the chain is directed around the smallest gear. Every

position on the gear selector should cause a gear change. Adjustments require fine tuning and should only be made by a qualified technician.

Avoid changing gears very rapidly from first gear to the last gear or vice versa. If you change multiple gears too quickly, you could cause the chain to come off the sprocket.

08 LED DISPLAY

RIDING MODES

Power Assist Sytem (PAS)

PAS 0: Full electric power, no power assistance

PAS 1: Low speed level, 5-10KM/H

PAS 2: Medium speed level, 10-15KM/H

PAS 3: High speed level, 15-20KM/H

PAS 4: Very high speed level, 20-25KM/H

PAS 5: Maximum speed level, 25-30KM/H

To ride in full electric mode (no pedaling), set your LED display to PAS 0. In this mode, your speed can be changed by twisting the throttle.

The speeds listed here are only for reference. Actual speeds will be affected by rider weight, temperature, road situations, incline, battery status, etc.

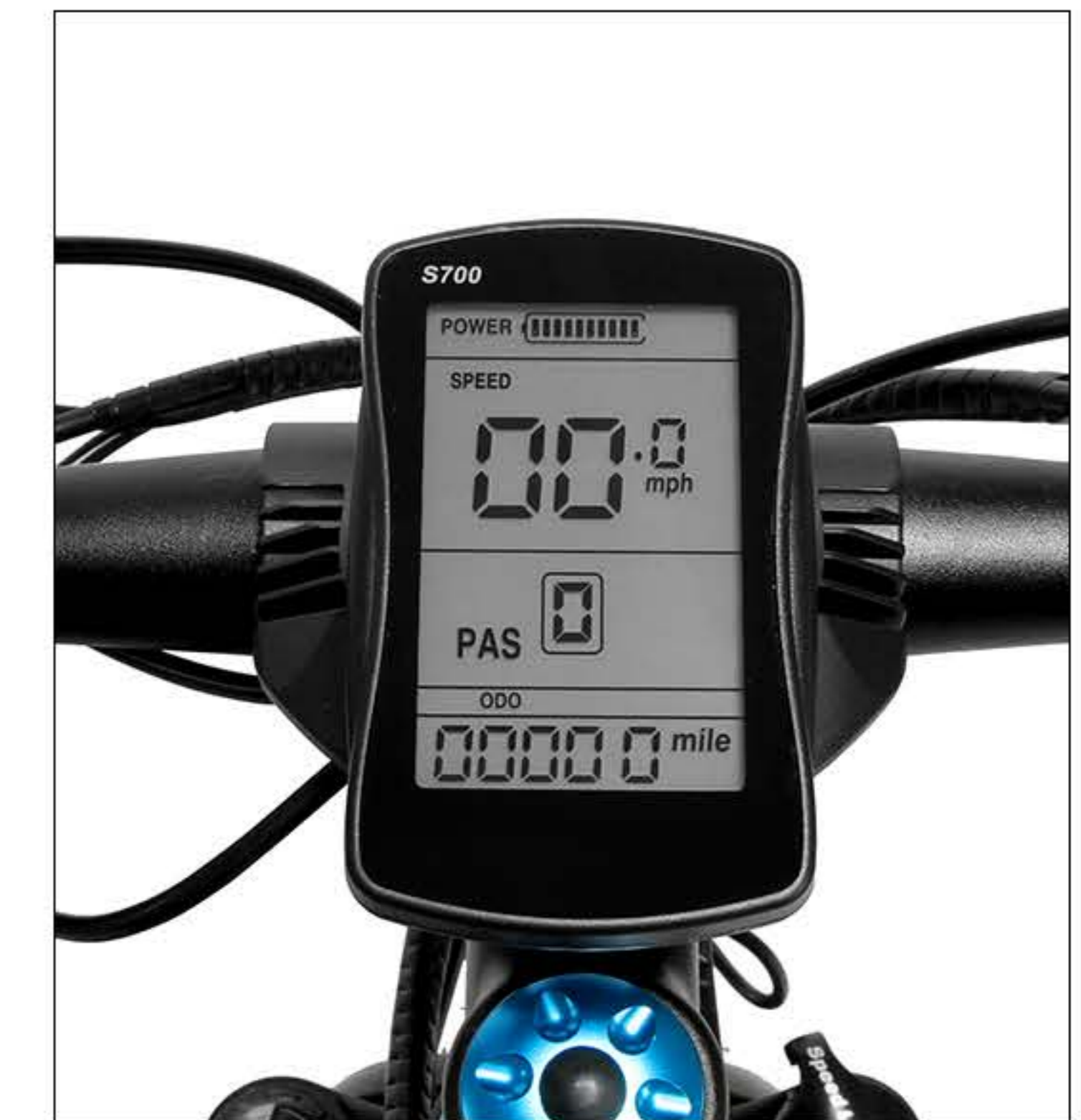

09 KEYS

Your BEZIOR electric bike comes with one or two keys:

- Ignition key
- The key to the battery holder on the bicycle frame

WARNING

Keep out of reach of children. Always keep your keys in a safe place to avoid losing them.

10 BRAKES

It's important to your safety that you instinctively know which brake lever controls which brake. On your BEZIOR E-Bike, the right brake lever controls the front brake. The left brake lever controls the rear brake.

Your BEZIOR E-Bike is equipped with disc brakes for maximum reliability. Applying hand pressure to the brake levers will cause the wheel brake to create friction against the brake disc, slowing the wheel. The more hand pressure applied to the brake lever, the faster the E-Bike will come to a stop.

The rear brake should always be applied before and while the front brake is applied. Applying only the front brake to slow or stop at high speeds may result in the rider being ejected from the saddle and continuing forward over the handlebars. It is best to apply even pressure to both brake levers when slowing or stopping.

Bicycles equipped with disc brakes will occasionally make a slight scraping noise when the wheels are turning without the brakes being applied. This is normal.

Make sure that the brake lever does not contact the handle bar when full hand pressure is applied (Figure 1). If so, then the brakes must be adjusted by increasing the tension on the cable.

A quick adjustment may be made by screwing or unscrewing the threaded barrel adjuster on the brake lever until the brakes are fine-tuned for safe stopping (Figure 2). If the brakes are still not operating correctly, they may require further adjustment by an experienced bicycle mechanic.

WARNING

- Disc brake rotors become hot during use. Do not touch or come in contact with the disc rotor shortly after use.
- Wet weather will require a longer distance to stop. Brake earlier and avoid sudden stops when riding in wet conditions.



FIGURE 1



FIGURE 2

11 TIRES & INNER TUBES

Tires should not be deflated unless necessary. To minimize tire wear and for maximum riding safety, comfort, and handling, maintain recommended tire air pressure. This can be found on the side wall of all tires. Use a reliable

tire air pressure gauge to check for proper inflation before every ride. At the same time, inspect tires for excessive wear and cracks. Replace tires if necessary.

12 APPEARANCE

Periodically clean your BEZIOR E-Bike with a damp cloth. Avoid spraying the BEZIOR with a water hose to avoid electrical issues. Store your lankeleisi in a dry, sheltered area away from direct sunlight and wet or damp environments.

It is also recommended to apply chain lube (such as Tri-Flow or ProLink) to the drivetrain of your E-Bike when you clean it up or wipe it down to keep it in good running condition.

13 TROUBLESHOOTING

If your BEZIOR E-Bike is not working, check the Quick Disconnect fittings to make sure they did not come loose or unplug

Simply unwrap the black spiral wire covering until the Quick Disconnect fitting is exposed, unplug and re- plug the Quick Disconnect fitting(s).

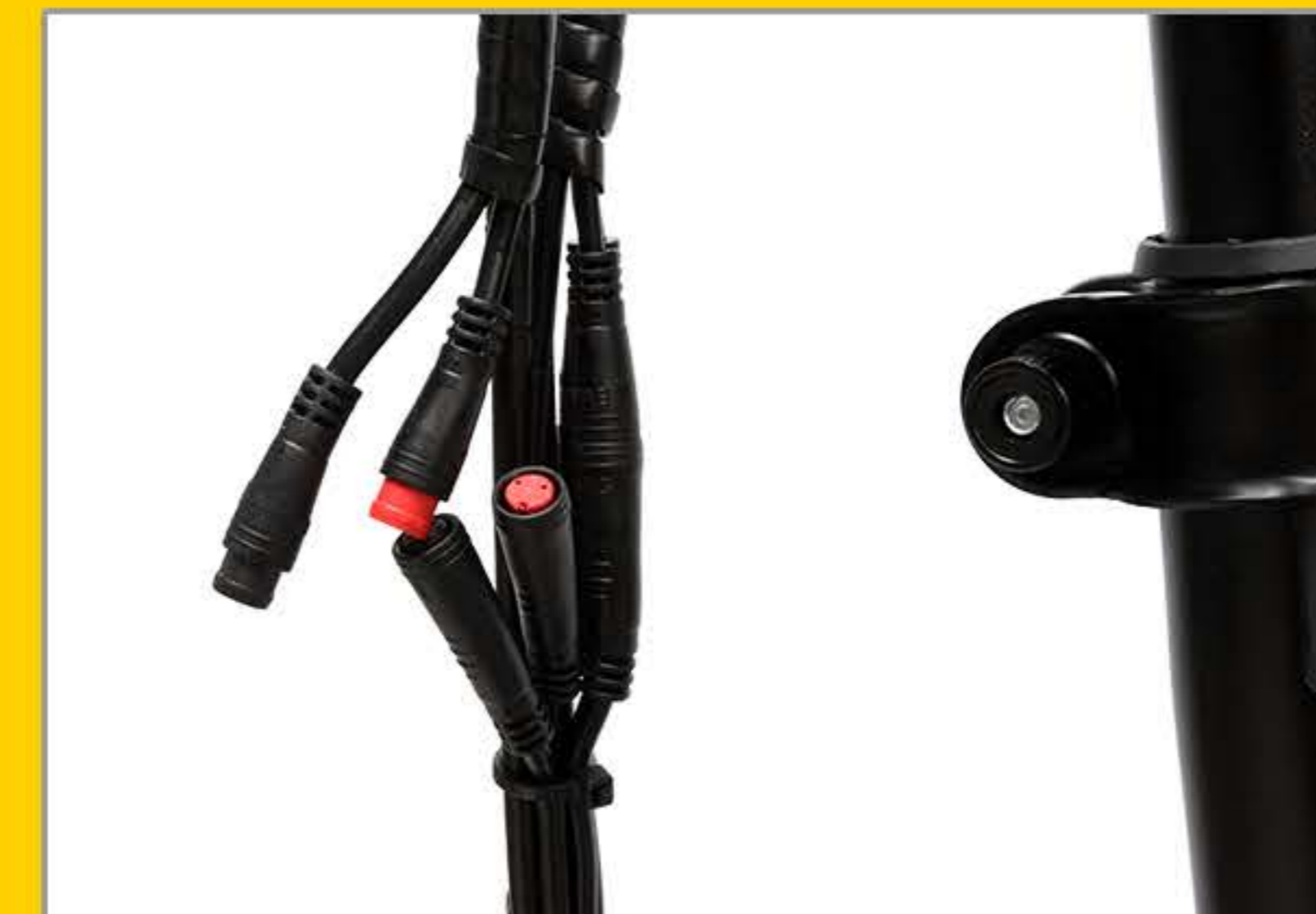

14

BEZIOR E-BIKE FAQS

Q. How long does it take to fully charge the battery?

A. It depends on the state of depletion, but around 3-6 hours if completely discharged.

Q. Can I ride up hills and against strong headwinds on my lankeleisi electric bike?

A. Yes. One of the main advantages of cycling on a lankeleisi electric bicycle is that it flattens hills and increases your average speed when tackling inclines and headwinds. If you provide a reasonable amount of effort, you should be able to tackle anything from a 10% gradient up to a 14% gradient. You will be amazed at the relative ease with which your new BEZIOR electric bike can tackle some of the most arduous journeys.

Q. Do I need to pedal an electric bike?

A. No, but it helps to prolong battery life. The motor on our bikes is both throttle and pedal assist controlled, allowing you to decide how much power you desire. Have you ever tried to cycle when speeding downhill on your normal bicycle? It's just like that. The motor is propelling you faster than you're cycling, so there is pretty much no resistance. It's merely a formality!



Q. What happens when I use the brakes under powered assistance?

A. All of our bikes are equipped with brake levers that have a built-in safety switch that automatically cuts off the motor power under normal braking conditions. This not only ensures a safe unpowered stopping feature, but also protects the motor under braking conditions so that it isn't working against the brakes.

Q. How far will a BEZIOR take me?

A. This all depends on a few factors. Cycling with pedal assist along a straight road under normal conditions, the standard battery should last about 35-50 km. Cycling up steep hills will obviously take more energy out of the battery and factors such as road surface, wind resistance, weight of the rider, and tire pressure will affect your range.

Q. What happens if I get a flat tire?

A. The tires on our bikes are the same as conventional bicycles. Simply replace the tube with a tube of the right size and inflate it. No special tires or parts will be needed.

Q. How do I know when the battery is low?

A. The bicycles have easily visible indicators located on the right handlebar or LED screen that show the amount of juice left. If it is getting low and you don't think you will make it to your destination, you can switch off your motor and keep it just for the difficult bits.

Q. Do I have to wait for the battery to empty before I charge it?

A. No. The batteries we use are Lithium-ion batteries which do not suffer from 'memory effect.' This means that there is no need to discharge a battery completely before you recharge it again. You can partially recharge the battery at any time without reducing its voltage or lifespan. We recommend recharging the battery after every use, regardless of how far you rode.



15

INSPECTION & MAINTENANCE



Hand brake cut-off power

When your bike is equipped with brake cut-off power set, the bike will automatically cut off power when the brake is used.

Low voltage protection

When the battery output voltage reaches its limit, the electronic control system will cut off the power to automatically protect the battery. When the battery reaches its minimum voltage, you can switch to pedal riding. The battery should be recharged before riding again.

Power off

When your E-Bike is not in use, please turn off the power.

Charge indicator

Red indicates charging, green indicates that the battery is full.

Note: The battery switch must be turned off using the switch on the bottom when the battery is charging. The battery must be fully charged before the first use. We recommend you charge the battery for a full 6 hours after your first 3 uses. If the bike is not used for a long time, you should fully charge and remove the battery. While not in use, keep the battery turned off and recharge every 2 months.

Make sure to keep the battery and charger away from children during charging.

Do not attempt to disassemble or modify the battery or charger.

Do not use the battery or charger for any use other than its intended purpose.

Battery charging

Plug in the connector between the charger and the battery, then plug the charger into an electrical outlet. The LED indicator on the charger will show red, which means charging. When the indicator light turns green, the battery is fully charged. When you are finished charging, first unplug the charger from the power supply, and then unplug the connector between the battery and the charger.

During the charging process, the charger and battery should be placed in a stable and cool place. The battery operating temperature range should be between 32 and 110 degrees Fahrenheit. Do not put any cover on the battery or charger. Make sure that no liquid comes into contact with the charger.

Mileage

Performance of electric bicycles is affected by road conditions, rider/load weight, and weather conditions. We recommend that you manually pedal as often as possible to improve your travel distance and battery life.

Inclines

When riding uphill on an incline of 15 degrees or more, we recommend using the pedal to assist your climb.

Cleaning

When cleaning your electric bicycle, wipe with a dry or damp cloth, do not spray directly with a hose. Do not put oil on the front brake.

The seat tube should be cleaned and lubricated if necessary.

Parking

Please make sure your BEZIOR E-Bike is parked in a stable place and the kickstand is used.

BASIC MAINTENANCE

1. To ensure that your E-Bike is in the best condition, maintain and clean regularly.

2. Regularly check that the tires are inflated correctly.

3. Make sure that quick release, nuts and bolts are tightened.

4. After a period of riding, check that the spoke tension is normal. Adjust as needed.

5. The frame and other parts are made of aluminum alloy. Avoid friction or collision and clean it regularly.

6. Do not take apart the motor, battery, or controller yourself. If necessary, take your E-Bike to a professional bicycle technician for repairs.

7. Do not use high-pressure water to clean your E-Bike. Keep water away from the controller, battery and motor.

8. Lubricate the chain, flywheel, head parts, kickstand, etc. when necessary.

16

WARRANTY CERTIFICATE

Important

BEZIOR warranties against manufacturer defects for all of our regular electric bikes and parts except accessories.

The warranty period begins on the delivery date within twelve (12) months.

Please note this warranty only covers the initial purchaser and DOES NOT cover accessories.

Validity

The warranty is valid only when:

- a)The Product is purchased from BEZIORauthorized dealers or outlets.
- b)The Product is NOT transferable to any third party either in ownership or during the period of contract.
- c)The model and serial label should not be defaced or removed from the Product.

Exclusion

The warranty is not applicable to:

- a)Damage or loss caused by modification, alteration, or repair by any unauthorized party.
- b)Damage or loss caused by mishandling by the customer or person(s) with access to the product on the customer's premises.
- c)Normal wear and tear.
- d)Damage or loss caused by Acts of God or any other causes beyond BEZIOR control.

e)Damage or loss as a result of external bodies.

f) Damage or loss caused by another device that is connected to the Product.

g)Damage resulting from accidents, misuse, abuse, tampering, or failure of the customer to follow normal operating procedures outlined in the user manual.

h)General maintenance and servicing.

BEZIOR E-Bike Warranty

In the rare case that your E-Bike arrives and does not work, the next course of action is repair or replacement AT MANUFACTURER'S DECISION. In order to honor the warranty the following must be followed:

- If your E-Bike is received with a defect, BEZIOR will take care of the shipping fees (at BEZIOR's instruction) and immediately ship replacement equipment or repair the equipment.
- If your E-Bike is in need of repairs, the owner must contact BEZIOR and will receive a Return Authorization (RA) Number and all of the necessary information. BEZIOR will not accept returns without an RA.
- All returns must be properly packaged to prevent damage during shipment. An explanation of the problem or damage and a proof of purchase must be submitted with the return which will be shipped by the owner.
- The RA number must be clearly visible.
- The owner will be responsible for insurance of the merchandise (at owner's cost) because BEZIOR will not be responsible for damages or losses during shipment.

The warranty is void if: The damages are a result of an accident, abuse, alteration, non-authorized usage, or use of electricity other than that indicated in this manual.

The warranty is void if: The owner or user neglected to do routine maintenance required and the damages or problems are directly related to such neglect. It is the user's responsibility to keep the E-Bike in proper condition.

Certain parts of the equipment are not covered by the lankeleisi warranty due to the fact that they require replacement after multiple uses. For example: buttons, pedals, seats, tires, etc. These parts will eventually require replacement at the owner's cost.

The manufacturers will not be held responsible for damages or monetary losses related to the purchase or use of their products. Tailwind denies responsibility for all physical and moral damages linked to the purchase and use of their products. In all cases, the damages cannot exceed the purchase price paid by the initial owner.

The final decision to honor the warranty is taken by BEZIOR personnel after a technical inspection when the owner returns defective products.

The warranty excludes:

1. Replacement and shipping costs of products worn out by normal use.
2. Replacement and shipping costs of products due to problems related to neglect, abuse, or lack of maintenance.

Warranties are NON-TRANSFERABLE.

Product Data

E-Bike Model: _____
 Serial Number: _____
 Purchase Date: _____
 Order Number: _____



 WWW.BEZIOR.COM
