

The image shows the cover of a HIMO C20 Use Manual. The background is a dark red color with a faint, semi-transparent image of a bicycle. The bicycle is positioned diagonally, with the front wheel on the right and the rear wheel on the left. The text is arranged in a grid-like pattern across the cover. In the top right corner, the brand name 'HIMO' is written in a bold, white, sans-serif font. Below it, the model name 'C20' is written in a stylized, italicized white font. Underneath 'C20', the words 'Use Manual' are written in a white, sans-serif font. In the bottom right corner, there is a block of white text providing instructions to read the manual before using the bike. The rest of the cover features the words 'P R O D U C T - M A N U A L -' in a white, sans-serif font, arranged in three rows: 'P R O D' on the first row, 'U C T -' on the second row, and 'M A N U A L -' on the third row.

HIMO

P R O D

U C T -

- M A N

U A L -

C20

Use Manual

Please read the instruction manual carefully before using your bike
Do not use the bike until you know its performance. Please keep the
instruction manual properly

Notes for using

Obey traffic rules strictly

- According to the regulations on the implementation of the road traffic safety law of the People's Republic of China, e-bike rider must be at least 16 years old.
- When driving in the non-motorized lane, the maximum speed shall not exceed 15km/h;On roads without non-motorized lanes, drive on the right side of the roadway.
- Don't cause injury by lending your bike to someone who can't handle it.
- Passengers or goods shall be carried according to laws and regulations.
- Riding in rain and snow, the braking distance will be extended, pay attention to slow down;Avoid traveling in bad weather such as heavy rain.
- Before riding, check the braking system and clean the reflector to avoid blocking.

Safe of using the product

- Please strictly abide by the traffic laws and regulations, prepare helmets, protective equipment and other protective equipment before riding, and pay attention to driving safety
- Do not ride with one hand or two hands away from the handle.
- Do not park in building doors, evacuation staircases, walkways, and safety exits.
- Do not charge inside residential building and park, should be far from combustible when charging, please charge according to regulation time, charging time should not be too long.
- Correct use and maintenance of batteries, old batteries can not be disassembled without authorization, should be organized by the professional departments recycling. Know how to use charger and warning terms, use original charger.
- When adjusting the saddle position, be careful not to expose the safety mark line of the saddle tube.

Preparation before riding

- Whether the power circuit and lighting are good.
- Whether the front and rear brake lever are good.
- Whether the handlebars and front and rear wheels are in a tight state.Whether the tire pressure is normal.

Cross country and extreme sports are prohibited

Bike coding position

XXXXXXXXXXXXXXXXXX

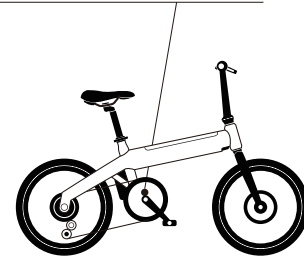

■ Electrical schematic

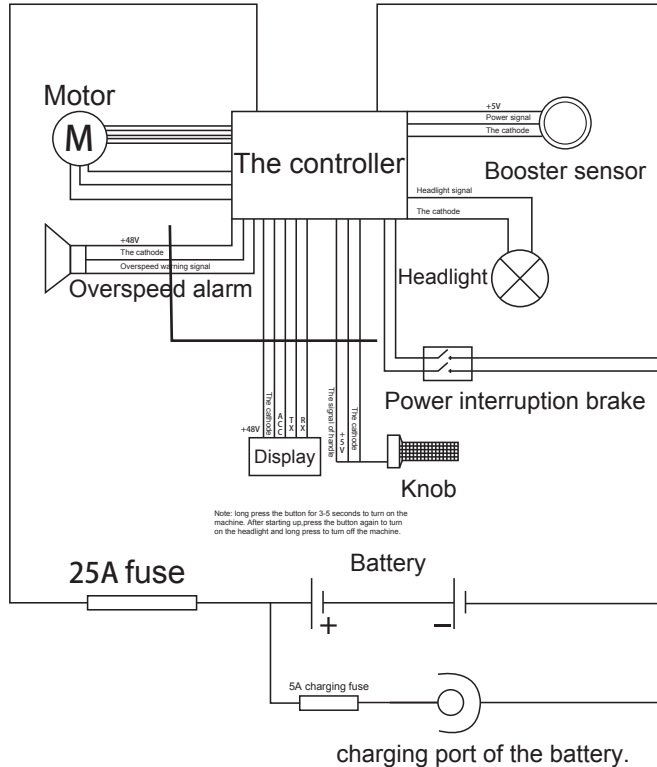

Main technical parameters of the bike

Dimensions	L*W*H	1470×610×1095mm
Front and rear wheel center distance		965mm
Max weight		21.6kg
Maximum design speed		25km/h
Assisting rang		≈80km
Electric range		≈55km
Consumes electricity (100KM)		0.654kW·h/100km
Loading weight		≤100kg

■ Under the condition of full power, loading weight is 75kg, the temperature is about 25℃, the environment of flat road is still without wind, and the driving condition is measured at 15km/h uniform speed under the energy-saving mode. The actual endurance will be different due to factors such as load, temperature, wind speed, road surface and operating.

Battery Spec.

Battery type	Lithium ion battery
Capacity	10Ah
Voltage	36V

Motor Spec.

Motor type	Brushless dc motor
Rated power	250W
Rated speed	260r/min
Voltage	36V

Controller Spec.

Under voltage protection	31±0.5V
Over current protection	15±1A

Operation and use

Folding steps

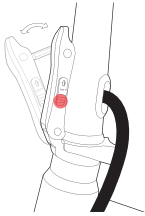

1. Push the handle switch upward and open the handle outwards



2. Turn the handlebar to one side

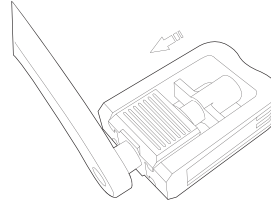

3. Press the pedal inward

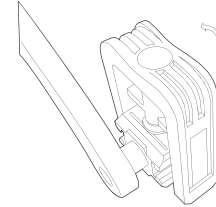

4. Flip the pedal and fold up

Steps of using the pump

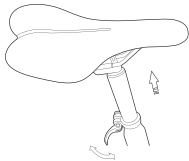

1. Open the seatclamp, pull out the seat post

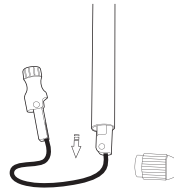

2. Unscrew the cap and extract the cylinder assembly

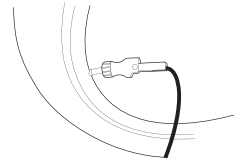

3. Put the air nozzle firmly at the valve nozzle

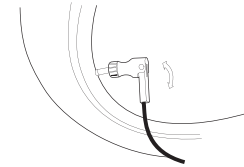

4. Flip the clasp 90 degrees hold the cushion and start pumping

Taillight opening and maintenance

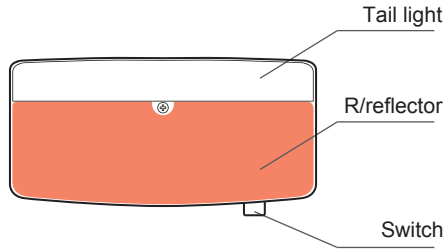

- Taillight is designed as an independent switch. Press the switch when using.

Change battery

- Prepare 1 suitable phillips screwdriver, 2 no. 7 batteries.
- Remove the tail light, unscrew the front panel screw, open the rear housing, and replace the batt
- Buckle the rear shell, screw well, install it on the fixing ery. plate, and finish replacing the battery.



Cross screw driver

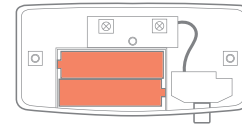
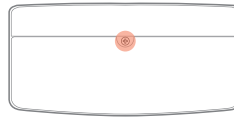

No. 7 battery
2 pcs

Check battery level

- Press the power button, the light is blue, the power is about 70% to 100%
- Press the power button, the light is green, the power is about 40-70%
- Press the power button, the light is red, the power is about 10%-40%
- If the light flashes, please charge in time

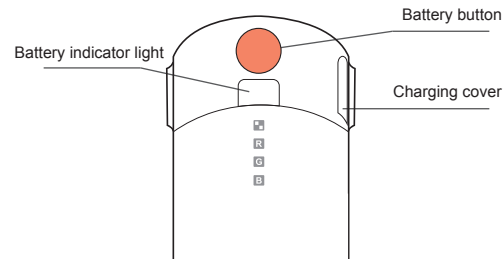

Display and riding mode

Dashboard introduction

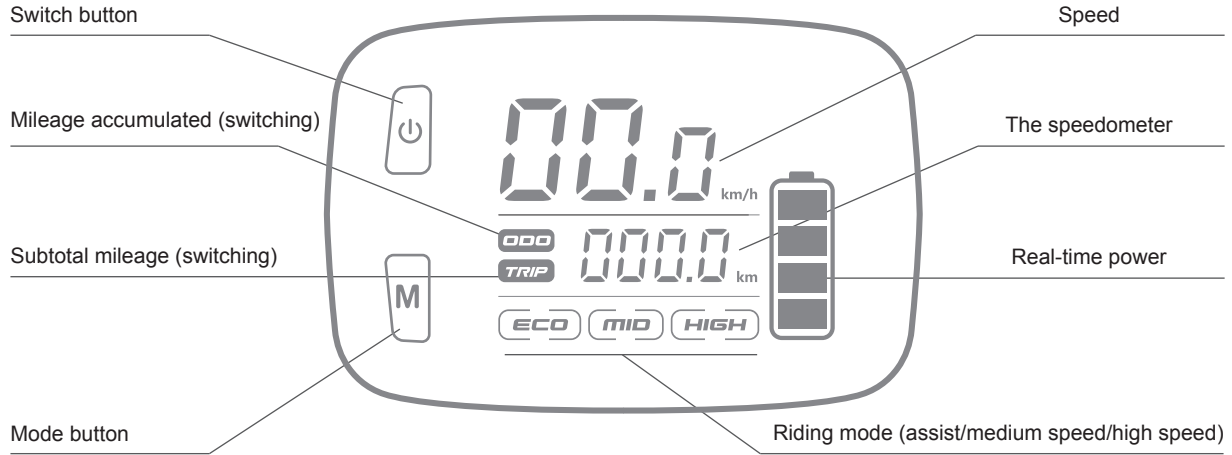

- Electric assist riding

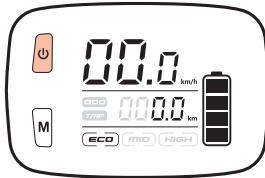

- Long press the switch for 3 seconds to start the bike;
- The first default gear is "ECO" assisted riding mode;
- This mode can be started by pedaling for two laps.

- Normal riding

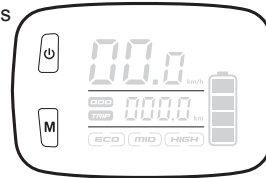

- Long press the switch for 3 seconds to shut down the electric car;
- Ride with pedal

- Electric riding

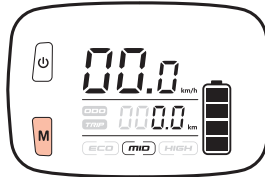

- Start the electric bike;
- Press the mode button to switch the mode to the gear of "MID" medium speed electric riding mode; If the speed exceeds 5km/h, turn the handle to start the mode.
- Press the mode button to switch the mode to the gear of "HIGH" high-speed electric riding mode; If the speed exceeds 5km/h, turn the handle to start the mode.

- Parking mode

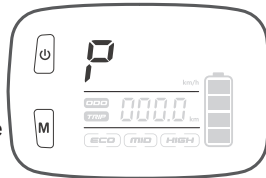

- In the startup state;
- Press the mode button for 3 seconds to switch to park (P) and open park mode.
- Long press the mode button for 3 seconds to close the parking mode.
- In park mode, power is not available in assist or electric ride mode.

Transmission using

Transmission diagram

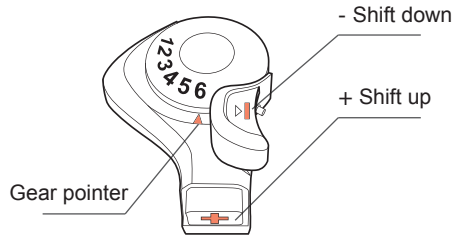

Gear	Power	Speed
1-2	Relaxed	Slow
3-4	Moderate	Moderate
5-6	Hard	Fast

- To speed up, start with a lower gear and shift to a higher gear as you speed up
- When going uphill, the speed will decrease and the gear will be lowered to maintain a certain pedal strength
- Downwind will speed up, increase gear to maintain a certain degree of pedal strength

The above is riding advice, according to personal habits to reasonable use of gear

When using the transmission system, also pay attention to the following details

- When using a gear system, try not to skip gears, which can easily damage the gear. It is not possible to change two gears at a time above, should be a level of adjustment, can better protect the gear system.
- Do not reverse the gear system when the bike stops running, or when it is going downhill. This will not only be bad for the gear system, but also may cause accidents.
- If it is their gear fault, or gear is not accurate situation, will affect the performance of the transmission, at this time should be timely to the professional bike shop maintenance, in case of aggravation of the fault.

Battery instructions

Battery removal and installation

- Turn the key, the battery pops up, and the battery is taken out
- First place one end of the battery in the slot
- Aim the other end of the battery at the charging port, press it gently and fasten the latch
- Key return, battery installed

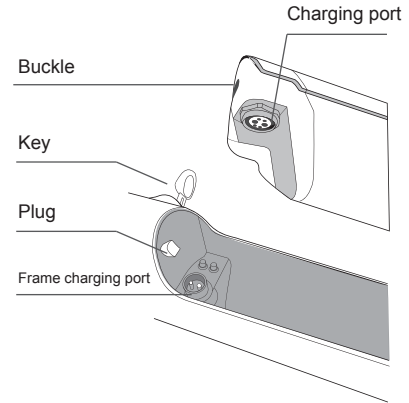
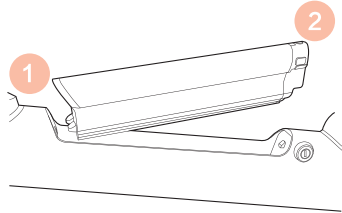

Battery charging

- Open the soft cover on the side of the battery
- The power supply pin of the charger is inserted into the charging port of the battery, and the power supply pin at the other end is connected to the power supply
- When charging, the charger status light is red
- When the battery is fully charged, the charger status light is green and the charging is finished
- Unplug the charger for safekeeping and close the soft cover
- If the battery is charged in the bike, please turn off the instrument power

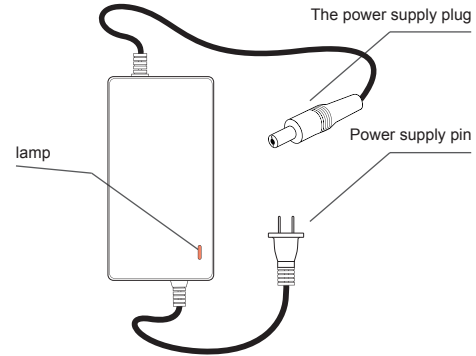
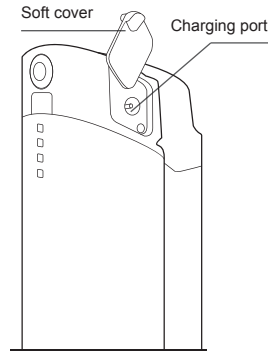

About batteries

Note before use of lithium battery

- Before use, confirm that the battery model is the original battery of the whole bike, do not use any other brand of battery.
- Check the appearance of lithium battery intact, no damage, leakage, heat and water, smoke and other obvious phenomena.
- In order to ensure the safety of transportation, the battery's output power is about 30%. Due to the self-consumption during the transportation and storage cycle, the battery is low or no electricity in the first use. This is a normal phenomenon.

Using the environment

- The best operating environment is 10 °C-45 °C
- At low temperature, available capacity of lithium battery will decrease to different degrees. The specific reference degree is as follows:
The available capacity is about 70% at -10 °C , 85% at 0 °C and 100% at 25 °C .If the battery has odor, heat, deformation and other abnormal conditions, please stop using immediately, away from the battery and contact the after-sales department.

Warning

The battery is not a part that can be repaired by the user. If there is any abnormal phenomenon, please contact the after-sales department for maintenance. Disassembling the battery without permission will not be covered by the three-pack policy and may cause the battery to generate heat, smoke, fire or explosion.

Charger port of the battery

- Use the original charger to charge the battery. Do not use other brand or model charger to charge the battery.
- Please charge the battery at the ambient temperature of 10°C ~ 40°C to ensure that there are no flammable substances around and good ventilation.
- Charging time indicates that if the charging time of the battery is less than 12 hours, overcharging will affect the battery life and there are safety risks.
- In the early stage of charging, the electric quantity rises quickly, while in the later stage, it is the procedure set for charging safety, which is the normal situation.
- When charging in winter, the outdoor temperature is relatively low. When the environment is below 0°C, the battery will stop charging. This is a normal phenomenon.
- Outdoor charging is strictly prohibited in bad weather.
- During the charging process, the charger has a temperature rise effect, and the surface temperature is relatively high, which is a normal phenomenon. Please feel free to use it, and pay attention to avoid children touching it.

Storage environment

- When the battery is placed on the bike, it will constantly consume the battery power. After the bike is placed for a period of time, the meter shows that the decrease of the battery power is normal.
- Please store the battery in the ambient temperature from 0°C to 25°C. Do not store the battery in an environment higher than 45°C, or it will cause irreversible
- capacity decay of the battery. If the bike is not in use for a long time (such as winter, summer or other special circumstances), the battery must be taken out and stored separately and charged regularly. Otherwise, the battery may be completely exhausted and irreversible damage may occur. For such problems, the battery fault will not be within the scope of three guarantee.
- The best storage capacity for a battery is 50%. Long-term storage of less than 10% or more than 90% of the battery will lead to irreversible capacity decay.
- Avoid storing batteries in hazardous locations. Falling may cause uncontrolled damage to the battery interior and may cause battery leakage, heat, smoke, fire, or explosion.

Description of component

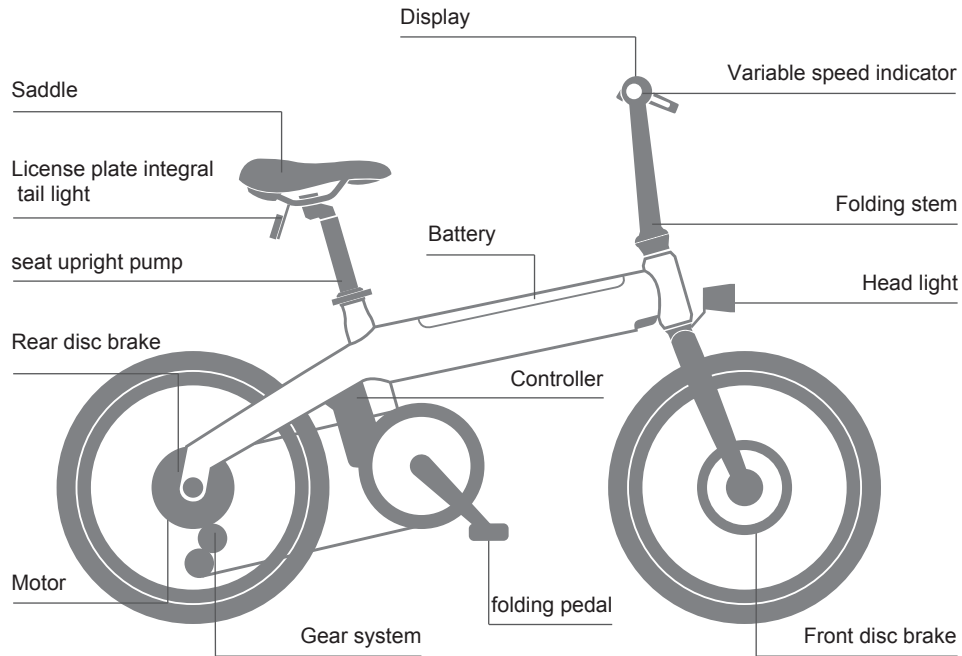

Solutions of trouble

Problems	Reasons for the problem	Solution way
When the power is turned on , the bike can not be powered on	Bike is not powered	1.Check whether the battery plug is properly inserted 2. Battery undervoltage, charge the battery
Turn on the power and turn on the handlebar,motor does not start	1.The bike is in the brake status 2.In the parking status 3.The speed did not reach 5km/h 4. Startup switch fault	1.Whether the brake lever is on the brake 2.Remove P mode 3.Manpower riding to 5km/h 4.Please contact after-sales service
Insufficient mileage	1.Battery undercharge 2.Tire pressure deficiency 3.Frequent brake start 4.Battery aging or normal 5.Low ambient temperature,Battery capacity attenuation	1.Check if the charger damage or not 2.Check tire pressure before using 3.Develop good driving habits 4.Replace the battery 5.Belong to normal phenomenon
Battery fails to charge	1.The charger is not plugged in properly 2.Battery temperature is too low 3.Battery temperature is too high	1.Check if the plug is loose 2.Wait for the battery to return to charging temperature 3.Wait for the battery to return to charging temperature
Instrument no display	1.No power supply for bike 2.Power converter damaged 3.Instrument faults	1.Check that the battery is plugged properly 2.Battery undervoltage, charge the battery 3.Contact after-sales service to replace damaged parts

Maintenance and repair

Regular bike inspection

- Whether the fastener is locked or not, whether the joints of all parts are normal:
- Whether the tread pattern of the tire is worn and cracked, whether the front and rear tire pressure is appropriate, Whether the drive system is smooth;
- Whether the brake system is working properly.

Bike storage method

- When this product is not in use for a long time, please do not store it in outdoor environment, under strong light and below zero, and keep it at least 2m away from heat source (heating equipment, etc.).
- Store in a dry, clean, well-ventilated indoor environment where the temperature is 10°C ~ 45°C and the relative humidity is no more than 90%.
- If you do not use the bike for a long time, pay attention to regular charging (generally about two months apart) to maintain battery performance;
- This product should not contact with corrosive liquid to avoid any mechanical impact and heavy weight.

The transportation

- Should not be subjected to severe mechanical impact, exposure to the sun, rain, chemical corrosive substances and harmful gases during transportation;
- During the process of loading and unloading, the products should be handled with care and be strictly protected against throwing, tumbling and heavy weight.

Maintenance and cleaning instructions

- Do not flush with water to avoid the risk of accident caused by wet internal electronic components and wiring;
- Please use neutral cleaner, wipe paint or plastic parts surface dirt with a cloth, and then use dry cloth to wipe;
- Please use lubricating oil to wipe the metal parts of the bike body for maintenance;
- Do not oil the brake parts to avoid causing brake failure and dangerous.

After-sales service

According to <Product quality of the People's Republic of China>&<Law of the People's Republic of China on the protection of user's right and interests>and the regulation of after sales service,the after sales service for HIMO electric scooter is as below:

Free reason in return within 7 days

- If the goods are rejected or intercepted due to non-quality reasons after shipment, the user shall bear the round-trip freight.
- Within 7 days after receipt, because of quality problems, in the case of does not affect the goods in good condition (affect the situation of the goods in good condition including but not limited to: guarantee certification and invoice lost, artificial damage, maintenance and protection label damage, product appearance, or the outer packing damage, 10 km mileage super, the accessory missing accessories, etc.).Return
- freight and wear and tear shall be borne by the customer.If the packaging is lost or damaged, the customer shall bear the original packaging cost (excluding the packaging cost incurred by logistics during return).
- If the goods are returned or replaced due to quality problems within 7 days after signing and receiving, the return freight shall be borne by the merchant. Offline channel purchase products do not support seven days without reason return.

No return for cycling more than 100 km;

It can be replaced within 15 days due to quality problems;

Beyond 15 days, within the warranty period, can be repaired.

The warranty policy

- During the warranty period, HIMO official customer service center will provide you with free after-sales service. If the service period and scope of "three guarantees" are exceeded, HIMO official customer service center will provide you with paid after-sales service according to the local market situation and maintenance price.
- If the product you purchased cannot drive due to quality problems, the HIMO official customer service center will provide you with maintenance services.
- The warranty period of online sold products shall start from the date of delivery receipt signed by the user.

Non-warranty policy

The following circumstances are not within the scope of warranty service, we will provide you with paid after-sales service.

- Three guarantees of validity have been issued;Missing or changed invoice;Damage caused by force majeure.
- Repair, misuse, collision, negligence, abuse, accident, modification, incorrect use of this product without HIMO's approval, frame serial number destroyed.
- The model of "three guarantees" certificate is inconsistent with or changed from the model of the repaired product;Do not follow the instructions for proper maintenance.
- Due to improper use, direct impact deformation;External force collision or car crash resulting in parts damage;Puncture and air leakage caused by spikes, glass, sharp small stones, etc.Consumable wear and tear is not replaced in time, causing damage to other parts;The surface of the cushion is scratched;Violence or man-made damage to the frame, are not covered by the warranty.
- The surface of the paint on the frame and parts may be corroded due to rain, collision, friction and other external environmental factors. The paint may fall off,or the storage place is not good. The surface of the paint may flake after long-term use, and the metal surface or plastic parts may fade naturally.
- Exceeding the scope of use, such as extreme road conditions, performing special effects, climbing stairs, jumping and other abnormal riding actions, and causing damage to parts or functional failure;
- Due to over-limit use caused by deformation or cracking of the frame, also does not belong to the scope of warranty.

Note: HIMO electric vehicle after-sales service policy is final interpreted by Shanghai HIMO electric technology co., LTD.

Responsibilities and obligations

Three guarantee policy

Item	Allowance for depreciation	The warranty period
Battery	From the date of receipt and signature, the HIMO authorized after-sales service center will provide after-sales service for you within the warranty period	24 month
Frame Fork	Natural open welding, off welding, fracture, deformation, paint off due to poor manufacturing quality problems	24 month
Hub, Freewheel, Chainwheel, Crank, BB Set, handlebar, Folding stem, Seat post, Head set, Wire	Distortion, breakage, fading, blistering, cracking, paint detachment, etc due to the poor manufacturing quality problem	12 month
Display, Controller, Head light, Charger	Performance failure or quality problem caused by the product and cannot be repaired	12 month
Tire, Inner tube, Saddle, Chain, Brake plate, Brake wire, Grip, Reflector, Pedal, and accessories.	Quick-wear part	Consumables are not guaranteed

Warranty exemption scope

If the product is sold in the following circumstances, it is not within the scope of warranty service, and users shall pay for maintenance and related services:

- The HIMO guarantee service standard for electric vehicle parts exceeds the specified service period and scope.
- Failure or damage of the HIMO electric vehicle product caused by the user's failure to properly use, drive, maintain and adjust the HIMO electric vehicle product according to the instructions.
- Products sold due to rain, snow immersion, smoke, drugs, chemicals corrosion caused by damage or natural product failure or damage.
- Loss is not covered by the warranty. And failure or damage caused by force majeure (including but not limited to earthquake, typhoon, fire, flood, social event, group event, violent crime, etc.) of the products sold.
- The battery was not normally used and maintained by the user, and the battery was placed for a long time (the battery was connected to the vehicle for a month, and the initial power of the battery was stored separately for less than 50% and more than 3 months), and the battery was not charged in time, resulting in battery feeding and undervoltage that could not be repaired.
- The user refits, disassembles, repairs or destroys the whole product and the normal use of the parts.
- The HIMO electric vehicle parts are damaged or the circuit or circuit configuration is changed without permission by the user using non-original parts.
- Product failure or damage caused by human factors such as car crash, car crash, overload and overspeed.
- There is no valid three-guarantee voucher, after-sales service card or purchase invoice, voucher or card number inconsistent with the product.



HIMO official public number

HIMO

The principal:Shang hai HIMO Electric Technology Co. LTD

Manufacturers:Tianjin Fuji-ta Technology Co. LTD

Manufacturer add:Taian road and AIMA road, south distr development zone, tianjin

Service number:400-182-9808