

# 12x20 Wood Gazebo/Gazebo en Bois

Item/Article #: A102032640

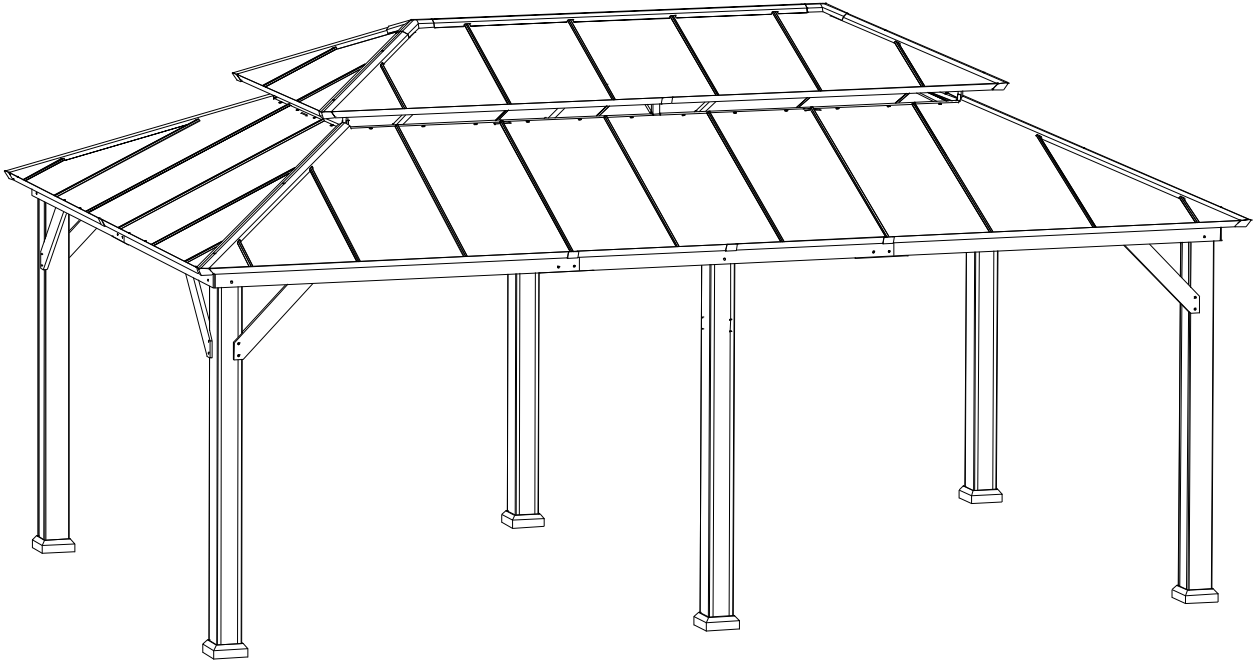

***Questions? Issues? Missing Part? Professional  
Installation Service?***

***Contact us at [customer.care@sunjoygroup.com](mailto:customer.care@sunjoygroup.com)***

***Questions? Problèmes? Pièce manquante?  
Service d'installation professionnel? Contactez-  
nous à [customer.care@sunjoygroup.com](mailto:customer.care@sunjoygroup.com)***



A10203264024



Country of Origin: China  
Pais d'origine: Chine

Production Number: 2024100756  
Numéro de fabrication: 2024100756

## Warnings :

- Any assembly or maintenance of the product must be carried out by adults only. We recommend at least 4 adults. / Tout montage ou entretien du produit doit être effectué uniquement par des adultes. Nous recommandons au moins 4 adultes.
- Please check your state and local regulations prior to purchasing. Some jurisdictions may require permits for installation and use. Some special procedures may be valid in your area. / Veuillez vérifier les réglementations nationales et locales avant d'acheter. Certaines juridictions peuvent exiger des permis pour l'installation et l'utilisation. Certaines procédures spéciales peuvent être valides dans votre région.
- Do not assemble the gazebo on sandy, muddy or loose soil, as stakes do not have enough anchorage in these types of soil. / Ne montez pas la tonnelle sur un sol sablonneux, boueux ou meuble, car les piquets n'ont pas assez d'ancrage dans ces types de sol.
- Install the gazebo on level ground. Stakes are provided to secure the gazebo to the ground. / Installez le belvédère sur un sol plat. Des piquets sont fournis pour fixer la tonnelle au sol.
- If you wish to secure the gazebo to a wood deck or concrete surface, use anchors suited to these surfaces (anchors not included). / Si vous souhaitez fixer le gazebo à une terrasse en bois ou à une surface en béton, utilisez des ancrages adaptés à ces surfaces (ancrages non inclus).
- Some parts may contain sharp edges. Wearing protective gloves is advised. / Certaines pièces peuvent contenir des bords tranchants. Portez des gants de protection si nécessaire.
- Keep children and pets away while setting up the gazebo. / Tenez les enfants et les animaux à l'écart de l'abri de jardin pendant son assemblage.
- Check all nuts and bolts periodically to ensure they are tightened. / Assurez-vous périodiquement que tous les écrous et boulons pour s'assurer que les ils sont serrés.
- Snow must be cleared off regularly during snowy days. Remove the snow at the roof top when it is thicker than 2 inches. In order to avoid damage, use a plastic snow rake to remove excessive snow and ice buildup from roof and keep away from falling debris. and removal of fallen debris. / La neige doit être déblayée régulièrement pendant les jours de neige. Enlevez la neige sur le toit lorsqu'elle est plus épaisse que 2 pouces. Afin d'éviter tout dommage, utilisez un râteau à neige en plastique pour enlever l'accumulation excessive de neige et de glace sur le toit et éloignez-vous des chutes de débris. et l'enlèvement des débris tombés.
- This gazebo is intended for decorative and sunshade purposes only and is not designed to withstand harsh weather, including high winds, rain, and snow. / Cet abri de jardin est conçu uniquement pour des fins décoratives et de pare-soleil, et il n'est pas conçu pour résister aux intempéries, notamment les vents violents, la pluie et la neige.
- If any scratches in paint occur, please touch up to prevent rustin / En cas de rayures sur la peinture, veuillez les retoucher pour éviter la rouille.

## Important:

- Please read and understand this manual before any assembly. Before beginning assembly of product, make sure all parts are present. Compare parts with packaging contents list.
  - When assembling wooden parts, do not overtorque the bolts to avoid splitting the wood. See image illustration.
  - Place all parts from the box in a cleared area and position them on the floor in front of you.
  - Remove all packing materials and place them back into the box. Do not dispose of the packing materials until assembly is complete.
  - Read each step carefully before beginning any assembly and make sure you understand each step. If you are missing a part, please email [customer.care@sunjoygroup.com](mailto:customer.care@sunjoygroup.com).
  - Needed for assembly: (The following tools are not included)
- Veuillez lire et bien comprendre ce guide avant de procéder à l'assemblage. Avant de procéder à l'assemblage du produit, assurez-vous que toutes les pièces sont présentes.
  - Lors de l'assemblage de pièces en bois, ne serrez pas trop les boulons afin d'éviter de fendre le bois.
  - Consultez l'illustration dans les schémas. Mettez toutes les pièces de la boîte dans une zone dégagée et positionnez-les sur le sol devant vous.
  - Retirez tous les matériels d'emballage et remettez-les dans la boîte. Ne les jetez pas avant d'avoir terminé l'assemblage.
  - Lisez chaque étape attentivement avant de commencer à assembler et assurez-vous de comprendre bien chaque étape. S'il vous manque des pièces, veuillez envoyer un email à [customer.care@sunjoygroup.com](mailto:customer.care@sunjoygroup.com).
  - Nécessaire pour l'assemblage : (les outils suivants ne sont pas inclus).

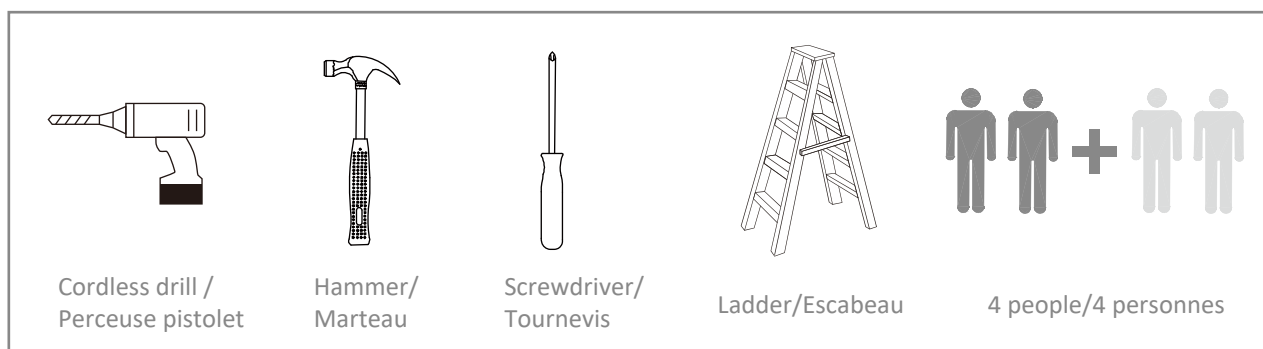

This identifies information that requires special attention. Improper assembly could lead to an unsafe or dangerous condition. / Cette icône identifie de l'information. Utilisez un niveau Vérifiez avec un équerre Serrer les boulons Mesurer la distance



### Use Level/Utilisez un niveau

Check that set or assembly is properly level before proceeding. / Vérifiez que l'assemblage est d'aplomb avant de procéder à la prochaine étape.

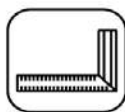

### Square Assembly/Vérifiez avec un équerre

Check that assembly is square before tightening bolts. / Vérifiez que l'assemblage est carré avant de serrer les boulons.

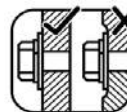

### Tighten Bolts/Serrer les boulons

Do not overtorque mounting bolts. Over-tightening may cause the wood to crack creating splinters and other structural damage. / Ne serrez pas trop les boulons de fixation. Un serrage excessif peut provoquer des fissures dans le bois, créant des éclats de bois et d'autres dommages structurels.



### Measure Distance/Mesurer la distance

**Installation blueprint/  
Plan d'installation**

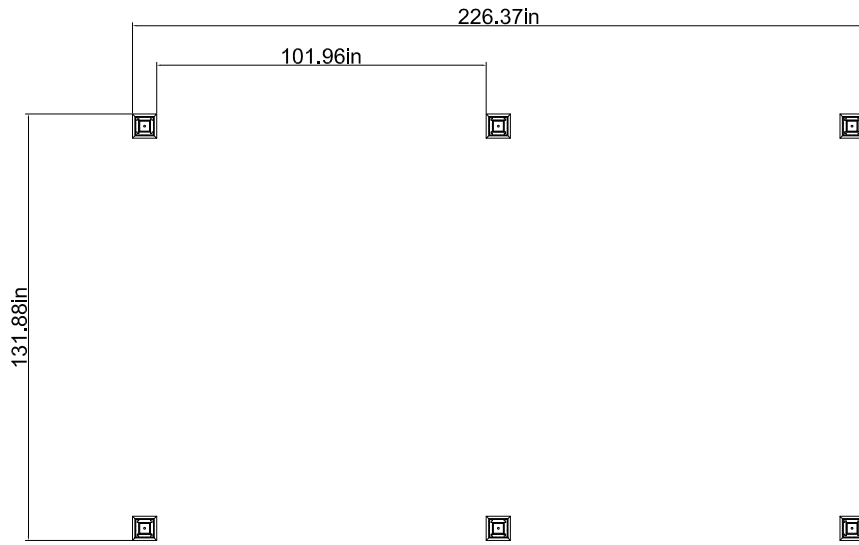



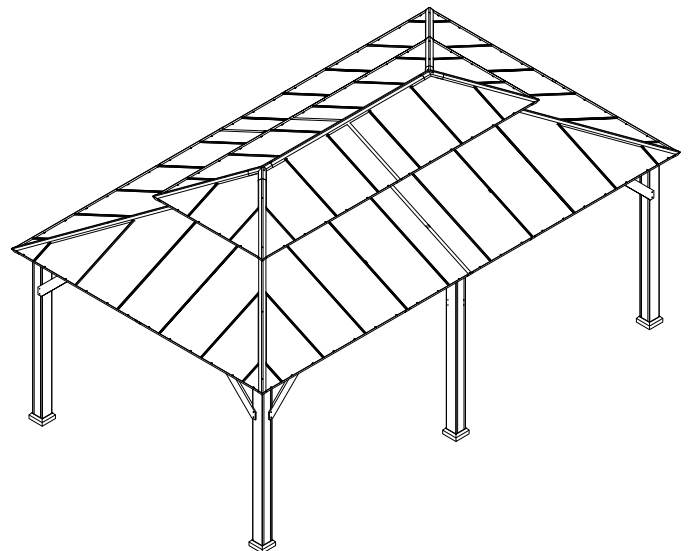
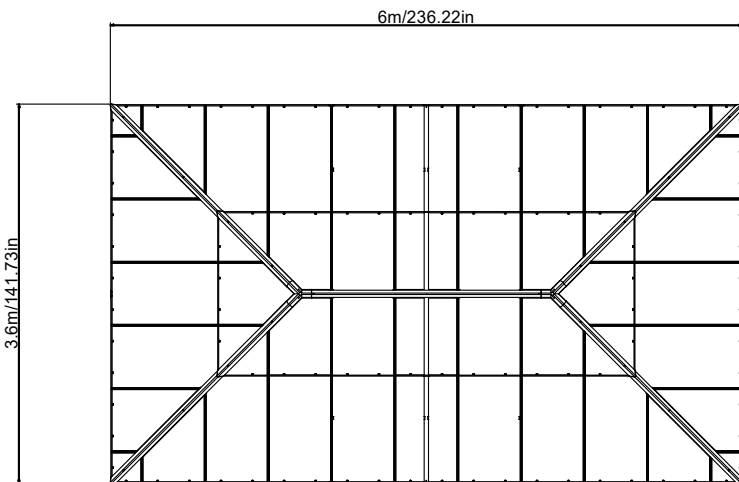
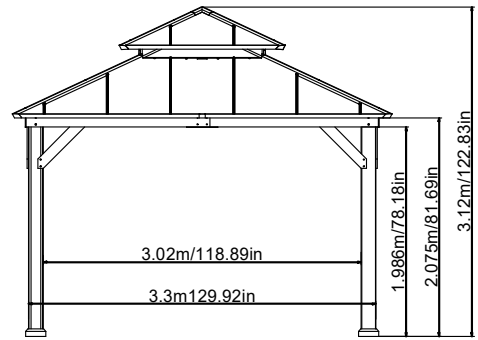
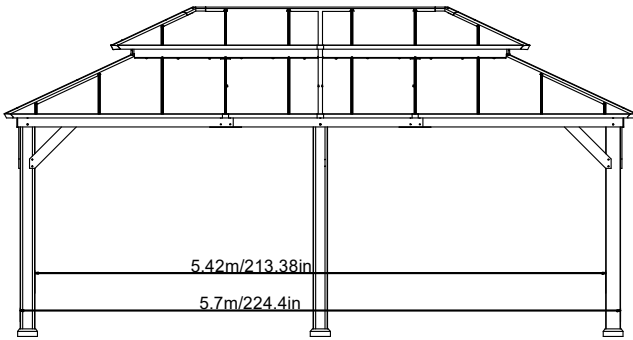



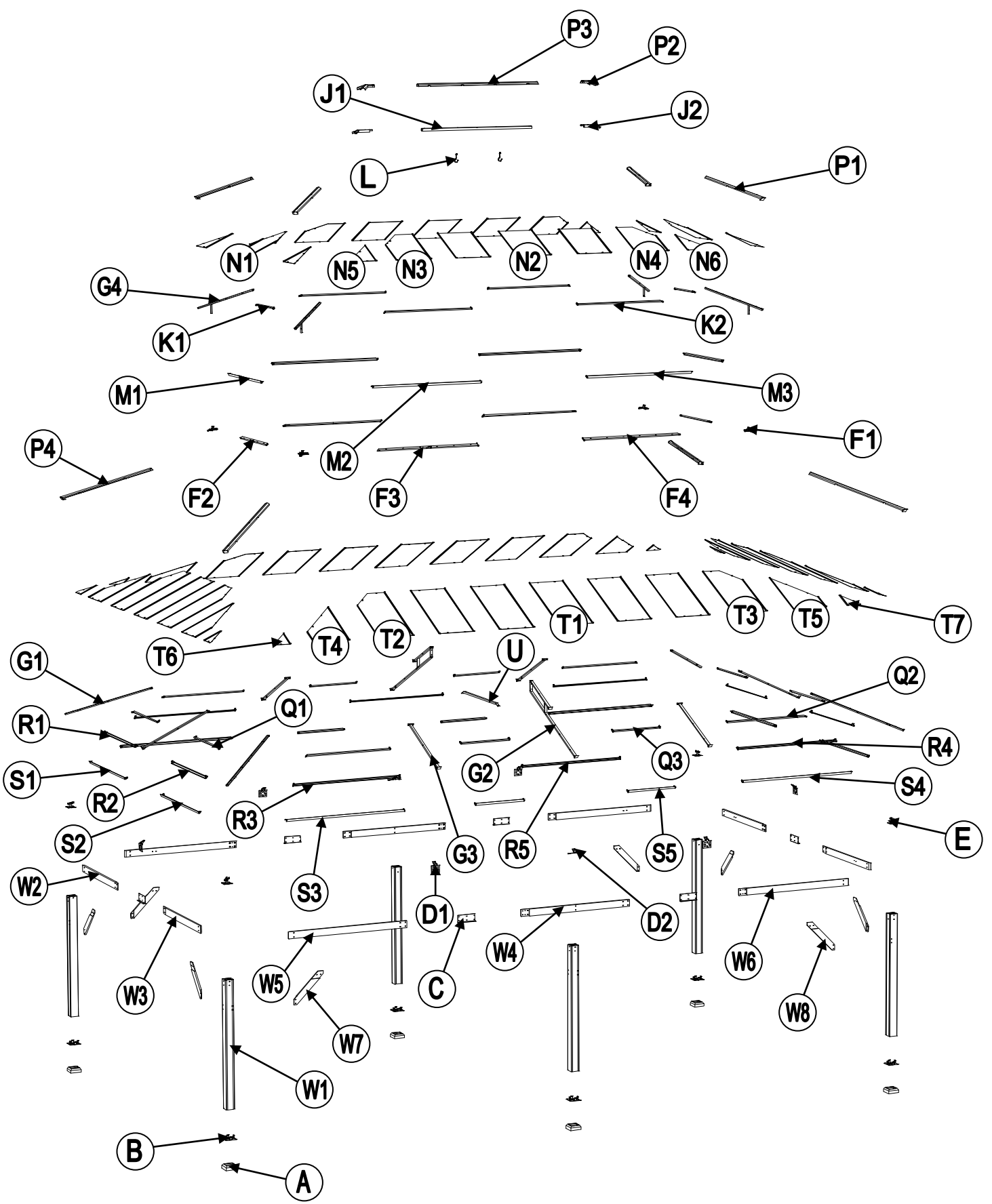



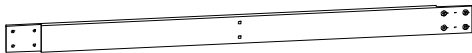





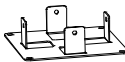
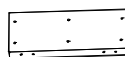

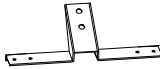

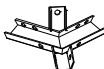











**Product size effect drawing/  
Dessin d'effet de taille de  
produit**





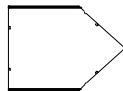
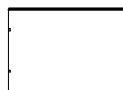
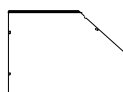





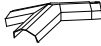









EXPLODED DRAWING/ DESSIN ÉCLATÉ











Parts List/Liste de Pièces				
Label/ Étiquette	Part Number/ Numéro de la Pièce	Description	Qty/ Quantité	Part Image/Numéro de la Pièce Diagramme
W1	P000200227	Post/Poteau	6	
W2	P00040165001	Left Short Cross Beam/ Traverse Courte Gauche	2	
W3	P00040165101	Right Short Cross Beam/Traverse Courte Droite	2	
W4	P00040165201	Middle Cross Beam/ Traverse Centrale	2	
W5	P00040165301	Left Long Cross Beam/ Traverse Longue Gauche	2	
W6	P00040165401	Right LongCross Beam/ Traverse Longue Droite	2	
W7	P005000320	Support Bar 1/Barre de Support 1	4	
W8	P005000321	Support Bar 2/Barre de Support 2	4	
A	P00610026102	Base Cover/Barde de la base	6	
B	P00010025102	Post Base/Base du Poteau	6	
C	P00220042601	Cross Beam Cap/ Capuchon De la Traverse	6	
D1	P00050189701	Big Roof Middle Beam Connector/Connecteur de poutre centrale de grand toit	6	
D2	P00050209801	Middle Beam Connector 2/Connexion de la poutre centrale 2	2	
E	P00050187702	Rafter Connector/ Connexion du Chevron	4	
F1	P00050209701	Big Roof Corner Frame/ Cadre d'angle de grand toit	4	
F2	P00050209601	Big Roof Short Connector Tube/Tuyau de Connexion Court du Grand Toit	2	
F3	P00050209401	Big Roof Long Connector Tube 1/Tuyau de Connexion Long du Grand Toit 1	2	
F4	P00050209501	Big Roof Long Connector Tube 2/Tuyau de Connexion Long du Grand Toit 2	2	
G1	P00060288401	Big Roof Rafter/ Chevron du Grand Toit	4	

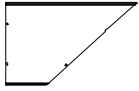





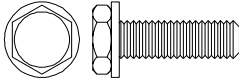
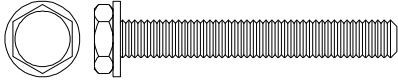
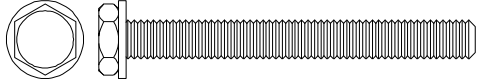
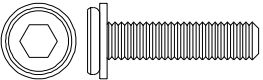

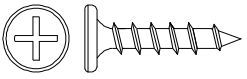
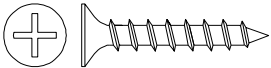

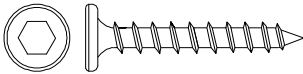
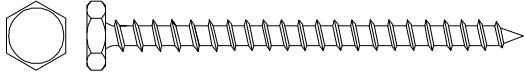
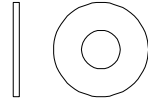
G2	P00060288601	Big Roof Middle Beam 2/Poutre Centrale du Grand toit 2	2	
G3	P00060288501	Big Roof Middle Beam 1 /Poutre Centrale du Grand toit 1	6	
G4	P00060287801	Small Roof Rafter/ Plafond du Petit Toit	4	
J1	P00050209001	Small Roof Long Connector Tube 1/Tuyau de Connexion Long du Petit Toit 1	1	
J2	P00050209101	Small Roof Long Connector Tube 2/Tuyau de Connexion Long du Petit Toit 2	2	
K1	P00060288001	Small Roof Small Beam(Short Side)/Petite Poutre du Petit Toit (Côté Court)	2	
K2	P00060287901	Small Roof Small Beam(Long Side)/Petite Poutre du Petit Toit (Côté Long)	4	
L	P00580015401	Hook/Crochet	2	
M1	P00060288301	Small Roof Panel Flashing (Short Side)/Solin du Panneau du Petit Toit (Côté Court)	2	
M2	P00060288101	Small Roof Panel Flashing 1(Long Side)/Solin du Panneau du Petit Toit 1(Côté Long)	2	
M3	P00060288201	Small Roof Panel Flashing 2(Long Side) /Solin du Panneau du Petit Toit 2(Côté Long)	2	
N1	P00070137301	Small Roof Middle Roof Panel(Short Side)/Panneau de Toiture Central du Petit Toit (Côté Court)	2	
N2	P00070137001	Small Roof Middle Roof Panel(Long Side)/Panneau de Toiture Central du Petit Toit (Côté Long)	6	
N3	P00070137101	Small Roof Left Big Roof Panel(Long Side)/ Panneau Grand Gauche du Petit Toit(Côté Long)	2	
N4	P00070137201	Small Roof Right Big Roof Panel(Long Side)/ Panneau Grand Droit du Petit Toit(Côté Long)	2	
N5	P00070137401	Small Roof Left Small Roof Panel/Panneau Petit Gauche du Petit Toit	4	
N6	P00070137501	Small Roof Right Small Roof Panel/Panneau Petit Droit du Petit Toit	4	
P1	P00080048601	Small Roof Rafter Cap/ Capuchon du Chevron du Petit Toit	4	

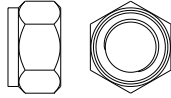
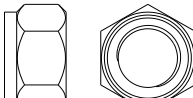
P2	P00090020801	Small Roof Cover 1/ Toiture du petit toit 1	2	
P3	P00090020901	Small Roof Cover 2/ Toiture du petit toitToiture du petit toit 2	1	
P4	P00080049001	Big Roof Rafter Cap/ Chevron du Grand Toit	4	
Q1	P00060288701	Big Roof Small Beam(Short Side)/Petite Poutre du Grand Toit (Côté Court)	4	
Q2	P00060288801	Big Roof Side Small Beam(Long Side)/Poutre Latérale Petite du Grand Toit(Côté Long)	4	
Q3	P00060288901	Big Roof Middle Small Beam (Long Side)/Poutre Centrale Petite du Grand Toit(Côté Long)	4	
R1	P00570055004	Left Mosquito Netting Rod(Short Side)/Tringle Gauche du Filet Moustiquaire(Côté Court )	2	
R2	P00570055104	Right Mosquito Netting Rod(Short Side)/Tringle Droite du Filet Moustiquaire (Côté Court)	2	
R3	P00570055202	Left Mosquito Netting Rod (Long Side)/Tringle Gauche du Filet Moustiquaire(Côté Long)	2	
R4	P00570055302	Right Mosquito Netting Rod (Long Side)/Tringle Droite du Filet Moustiquaire (Côté Long)	2	
R5	P00570040701	Big Roof Middle Mosquito Rod (Long Side)/Tringle Centrale du Filet Moustiquaire du Grand Toit(Côté Long)	2	
S1	P00060289001	Big Roof Panel Flashing 1(Short Side)/Solin du Panneau du Grand Toit 1 (Côté Court)	2	
S2	P00060289101	Big Roof Panel Flashing 2(Short Side)/Solin du Panneau du Grand Toit 2 (Côté Court)	2	
S3	P00060289201	Big Roof Panel Flashing 1(Long Side)/Solin du Panneau du Grand Toit 1 (Côté Long)	2	
S4	P00060289301	Big Roof Panel Flashing 2(Long Side)/Solin du Panneau du Grand Toit 2 (Côté Long)	2	
S5	P00060289401	Big Roof Middle Panel Flashing(Long Side)/Solin du Panneau Central du Grand Toit (Côté Long)	4	
T1	P00070137601	Big Roof Middle Roof Panel /Panneau du Toit Central du Grand Toit	12	
T2	P00070137701	Big Roof Left Big Roof Panel /Panneau de Grande Toiture Gauche du Grand Toit	4	

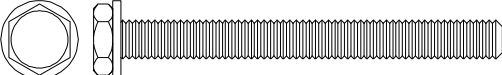

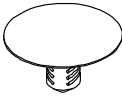
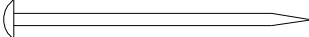
T3	P00070137801	Big Roof Right Big Roof Panel /Panneau de Grande Toiture Droit du Grand Toit	4	
T4	P00070137901	Big Roof Left Middle Roof Panel /Panneau de Toiture Central Gauche du Grand Toit	4	
T5	P00070138001	Big Roof Right Middle Roof Panel/Panneau de Toiture Central Droit du Grand Toit	4	
T6	P00070138101	Big Roof Left Small Roof Panel/Panneau de Petite Toiture Gauche du Grand Toit	4	
T7	P00070138201	Big Roof Right Small Roof Panel/Panneau de Toiture Petit Droit du Grand Toit	4	
U	P00500085701	Support Bar 3/Barre de Support 3	1	

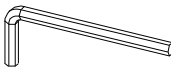
Hardware Pack/Pack Quincaillerie					
Label/ Étiquette	Part Number/ Numéro de la Pièce	Description	Qty/ Quantité	Add	Part Image/Numéro de la Pièce Diagramme
H1	H100010047	Bolt M6*20/ Boulon M6*20	302	16	
H2	H100010059	Bolt M6*45/ Boulon M6*45	16	1	
H3	H100010051	Bolt M6*55/ Boulon M6*55	2	1	
H4	H100040020	Bolt M8*30/ Boulon M8*30	24	2	
H6	H100010165	Bolt M10*185/ Boulon M10*185	10	1	
H7	H030080005	Screw ST4.8*25/ Vis ST4.8*25	60	3	
H8	H030050058	Screw ST4.8*30/ Vis ST4.8*30	64	4	

H9	H030030013	Screw ST8*35/ Vis ST8*35	32	2	
H10	H030010031	Screw ST9.5*80/Vis ST9.5*80	10	1	
H11	H050030001	Flat washer M6/Rondelle Plate M6	2	1	
H12	H050080007	Flat washer M8/Rondelle Plate M8	32	2	
H13	H050080008	Flat washer M10/Rondelle Plate M10	20	1	
H14	H040070002	Nut M6/ Écrou M6	2	1	
H15	H040050026	Nut M10/ Écrou M10	10	1	
H16	H040090004	T-Nut M8*8/ T-Nut M8*8	24	2	
H17	H090990002	M3 Drill	2	0	
H18	H100010073	Bolt M6*60/ Boulon M6*60	4	1	
HH1	H050050018	M6 Rubber Washer/Rondelle en Caoutchouc M6	20	1	
HH2	H990010010	Black Plastic Buckle/Boucle en plastique noir	32	2	
HS	H070010003	Stake $\Phi$ 8*180/ Piquet $\Phi$ 8*180	12	0	
HW1	H090010017	Wrench M6/ Clé M6	2	0	
HW2	H090030005	Allen Wrench M8 /Clé Allen M8	1	0	
HW3	H090010015	Wrench M10/ Clé M10	2	0	

# 1

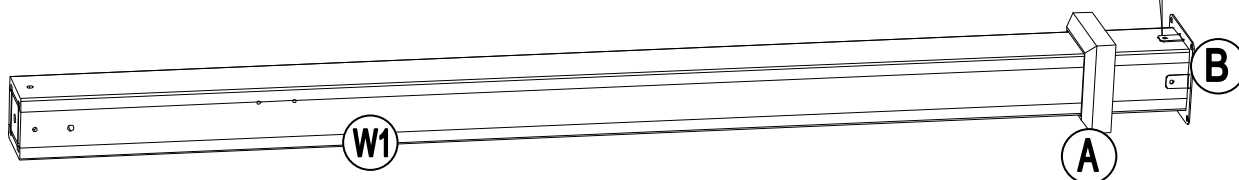
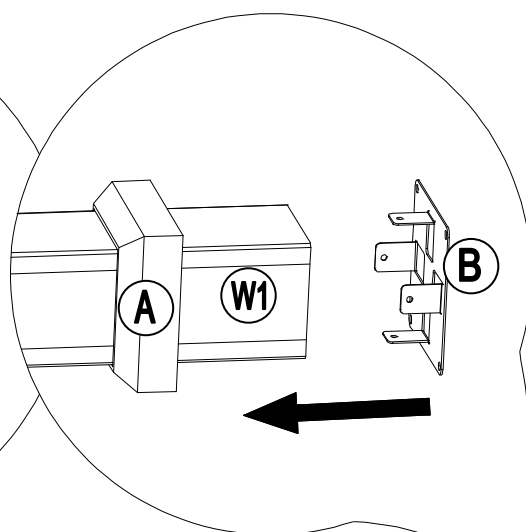
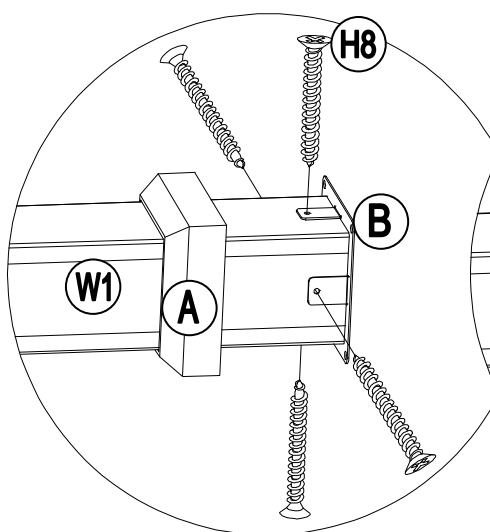
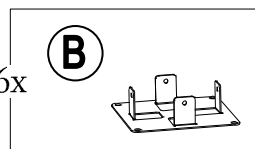
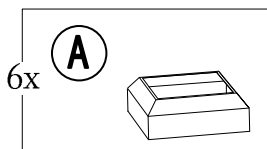
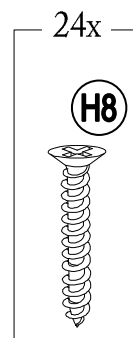
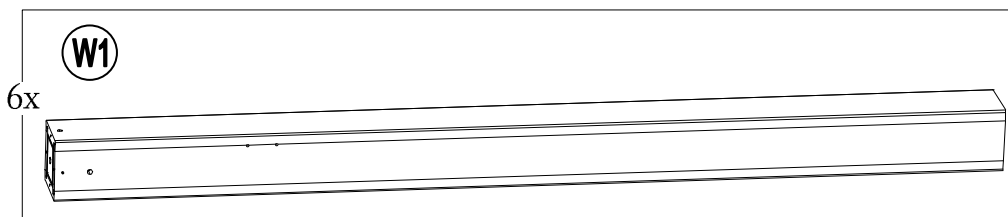

# 2

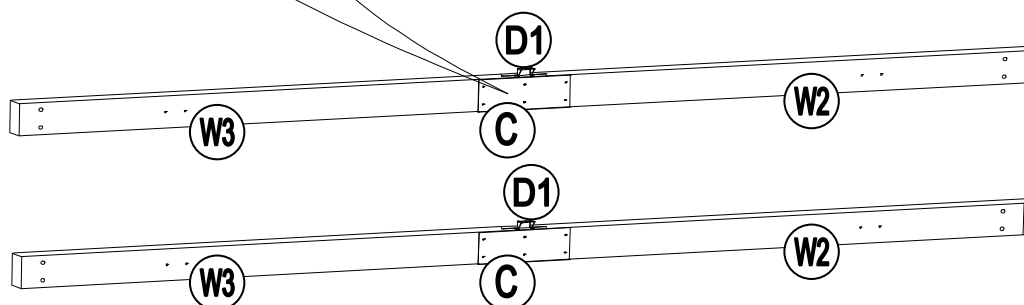
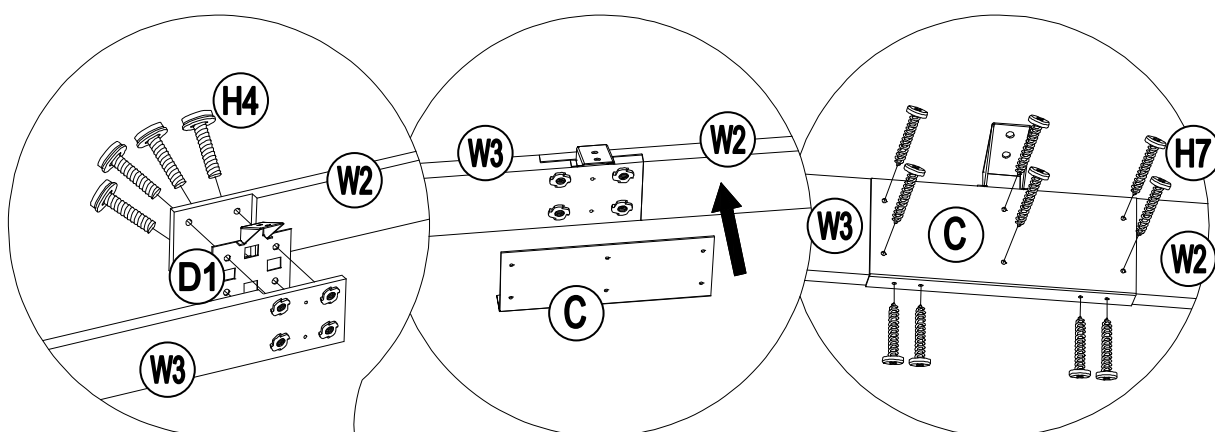
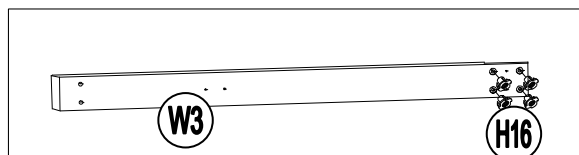
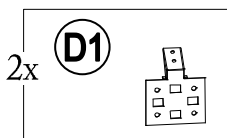
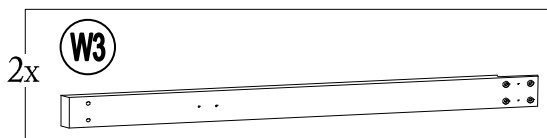
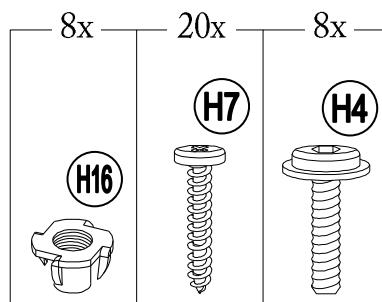
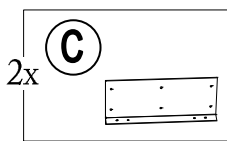
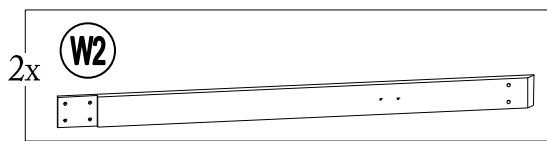

# 3

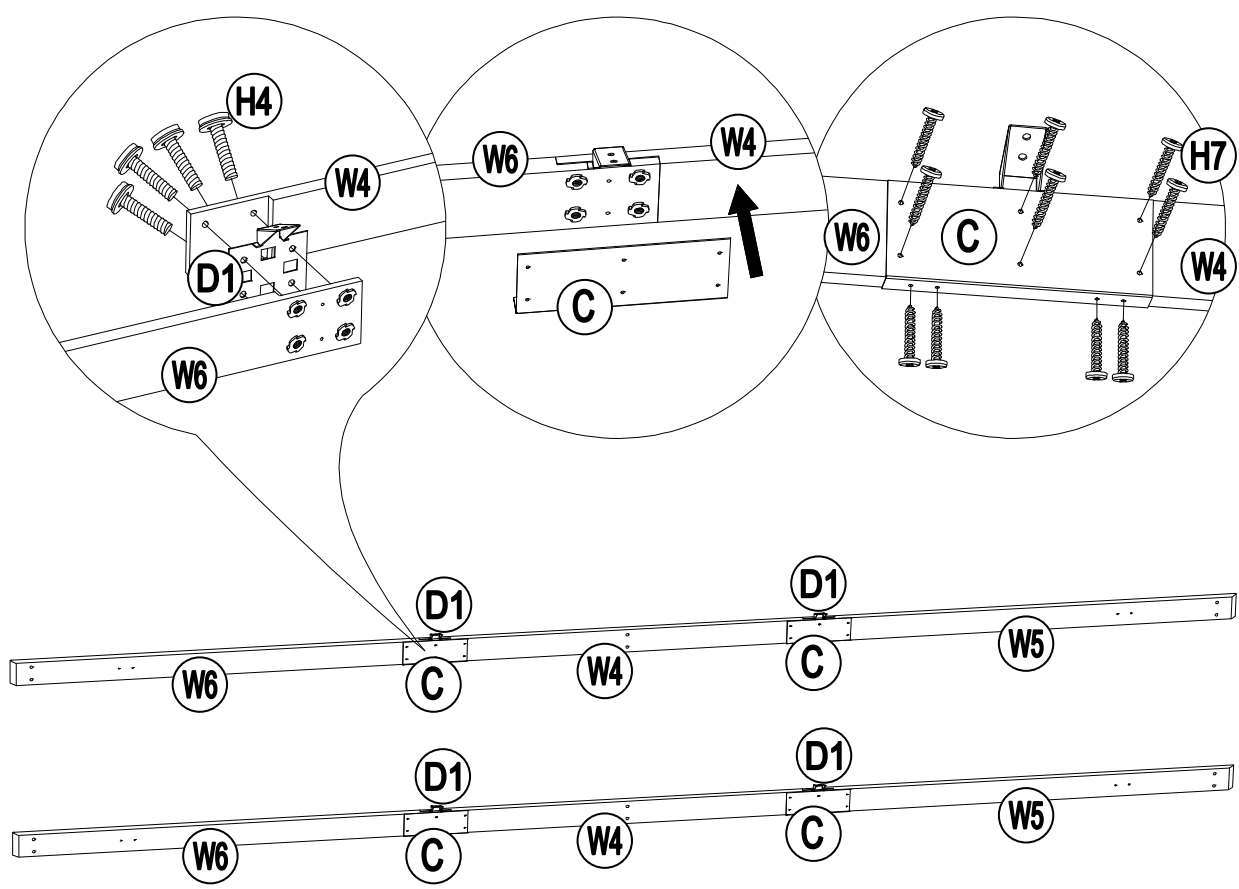
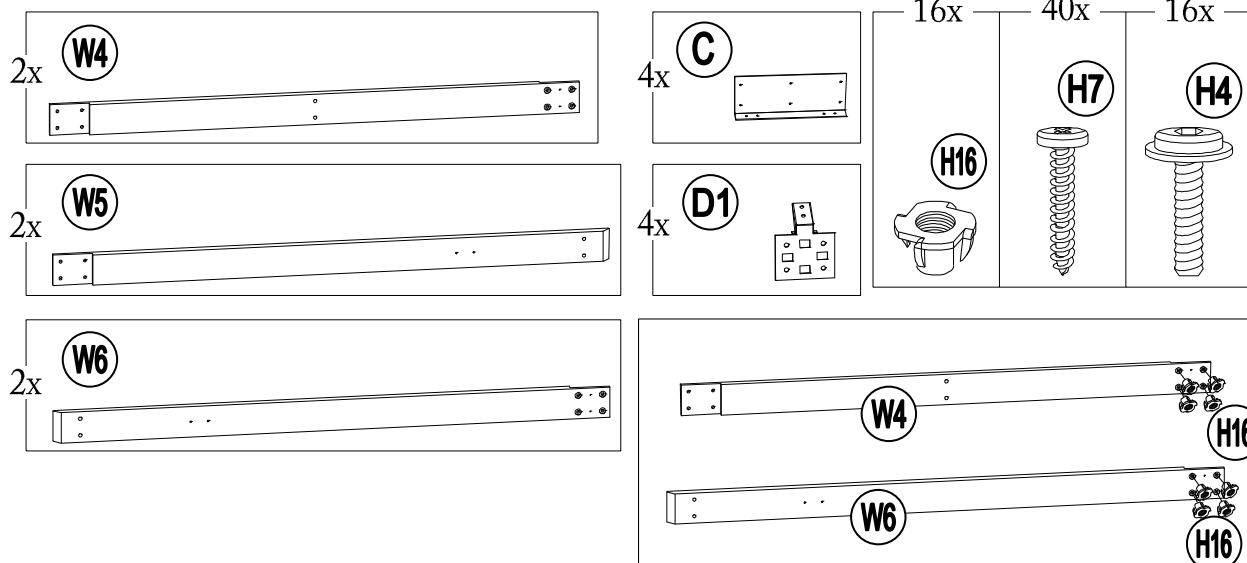

# 4

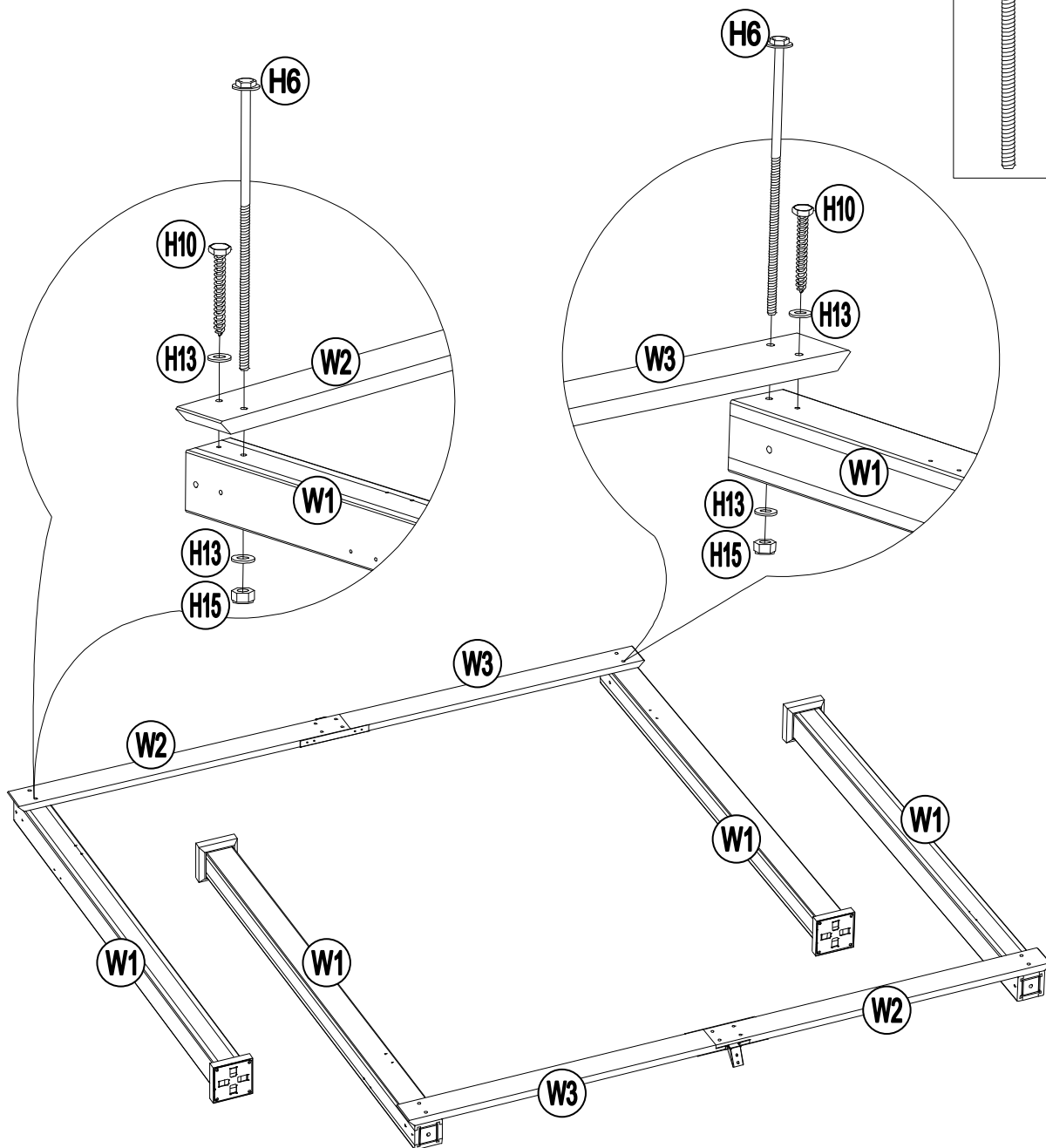
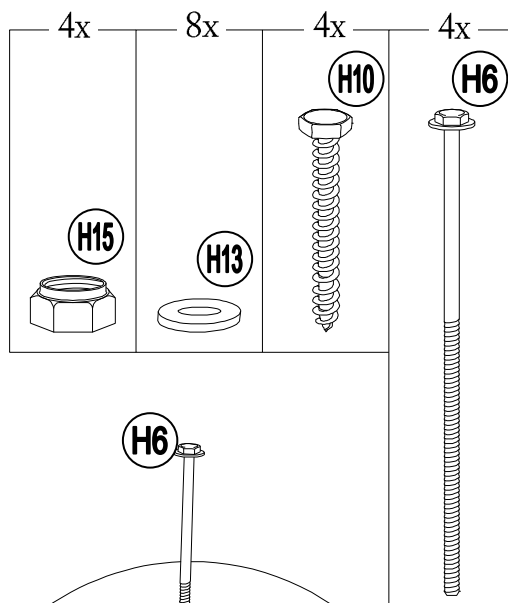

# 5

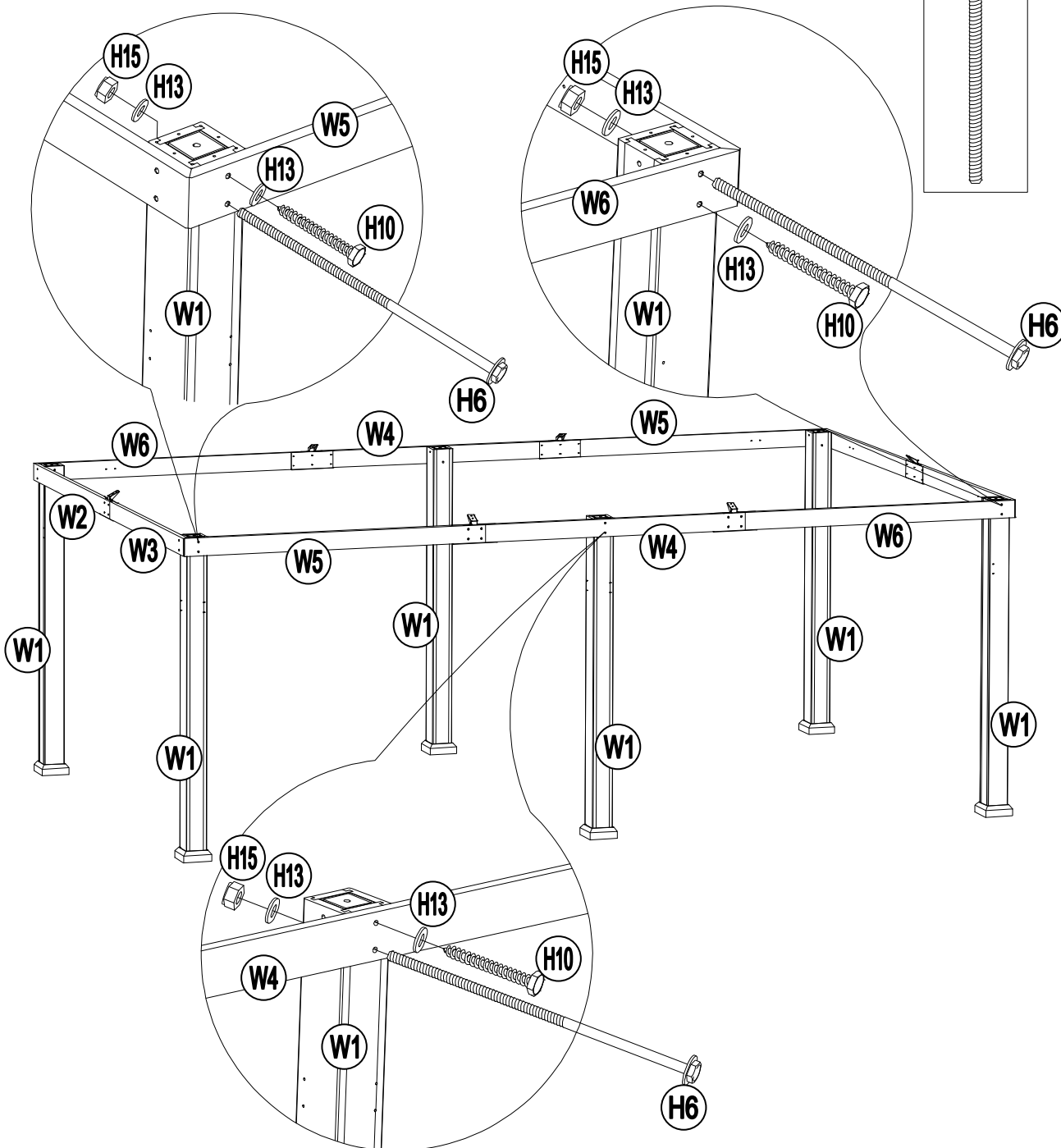
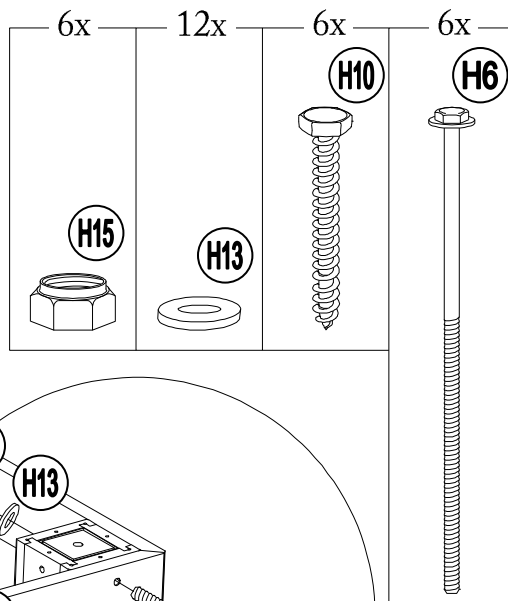

6

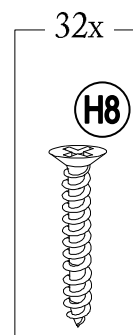
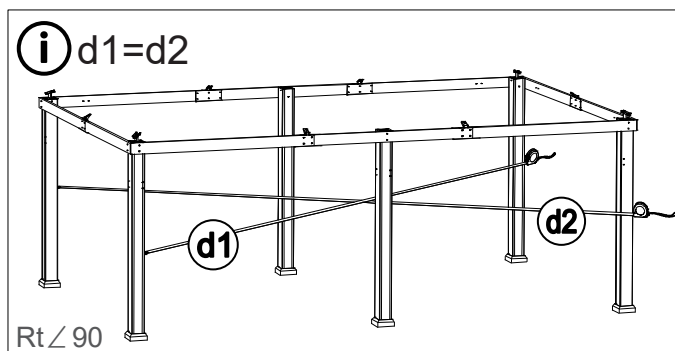
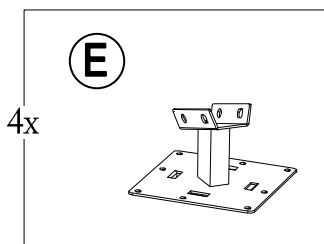

Please measure to make sure the length of d1 is equal to d2 before moving to next step to ensure a square frame and best results. Keep the beam at right angles to the post, the post at right angles to the ground, and keep the beam horizontal. /Avant de passer à l'étape suivante, veuillez prendre des mesures pour vous assurer que la longueur de d1 est égale à celle de d2 afin d'obtenir une armature carrée. Maintenez la traverse à l'horizontal en angle droit par rapport au montant et le montant en angle droit par rapport au sol.

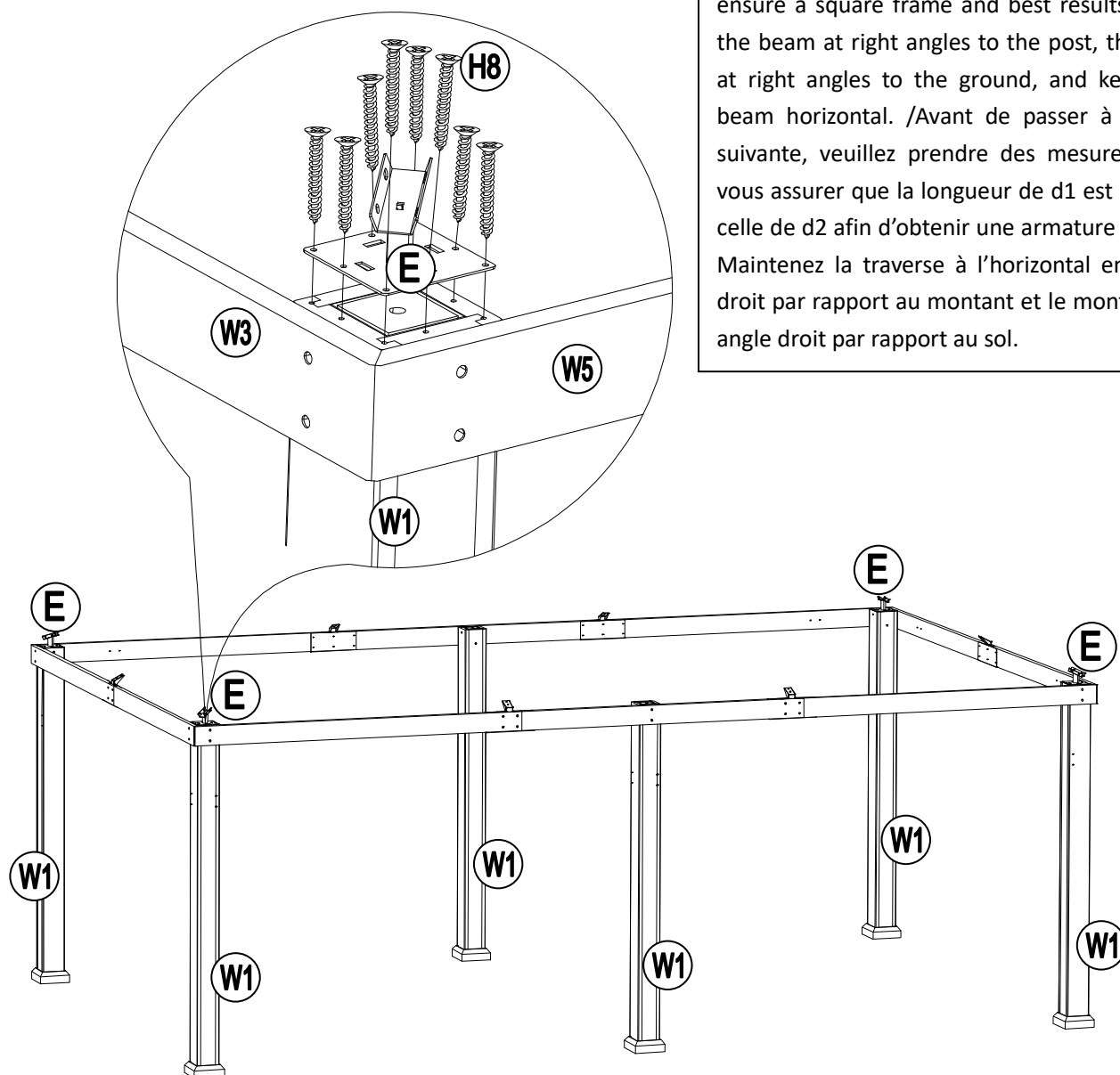



# 7

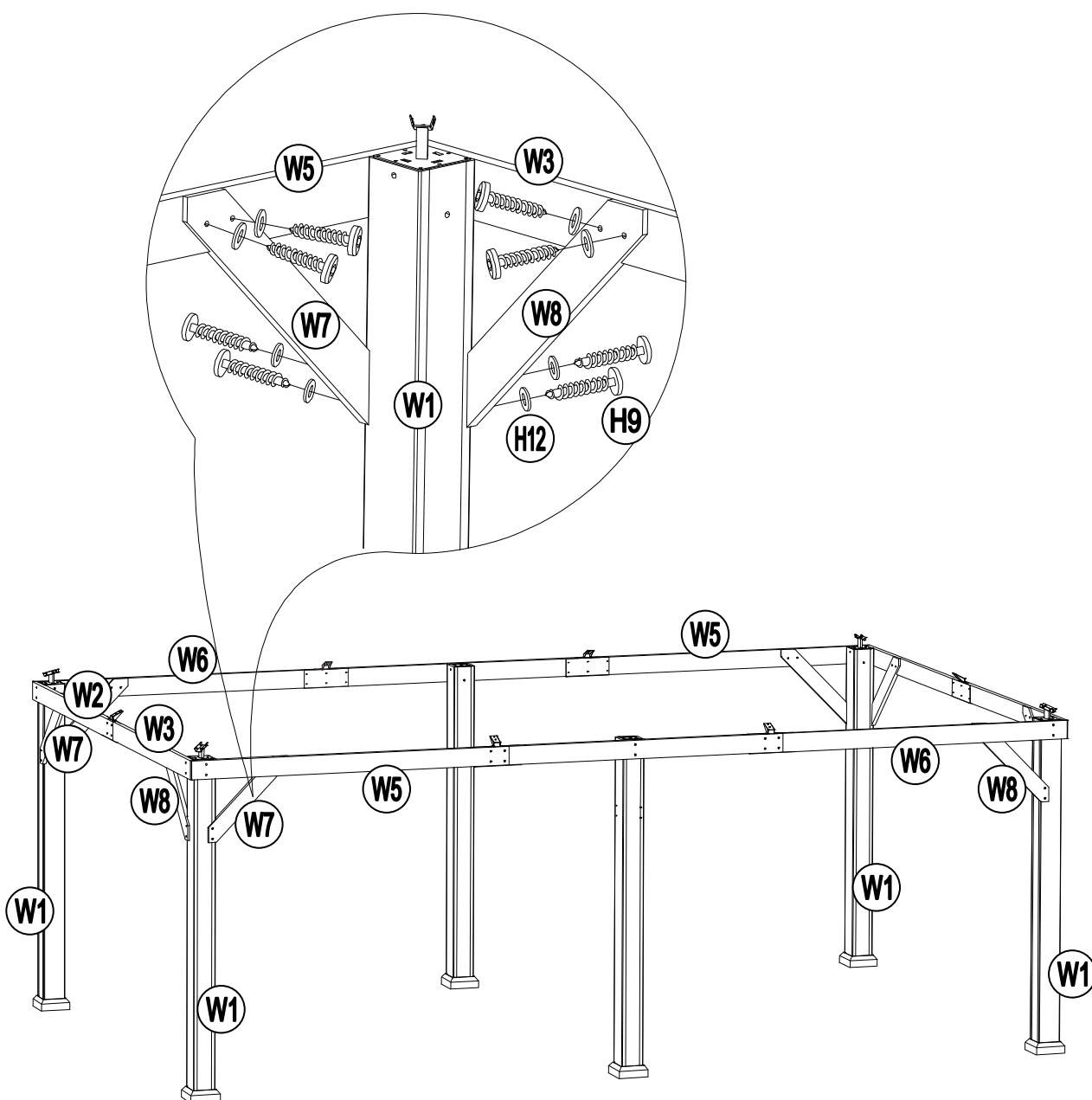
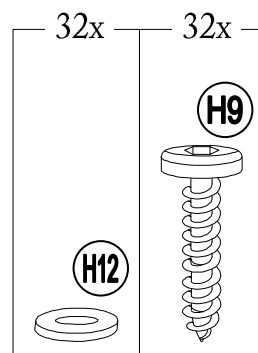
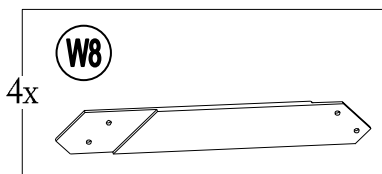
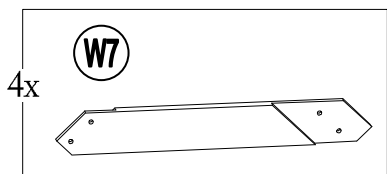

# 8

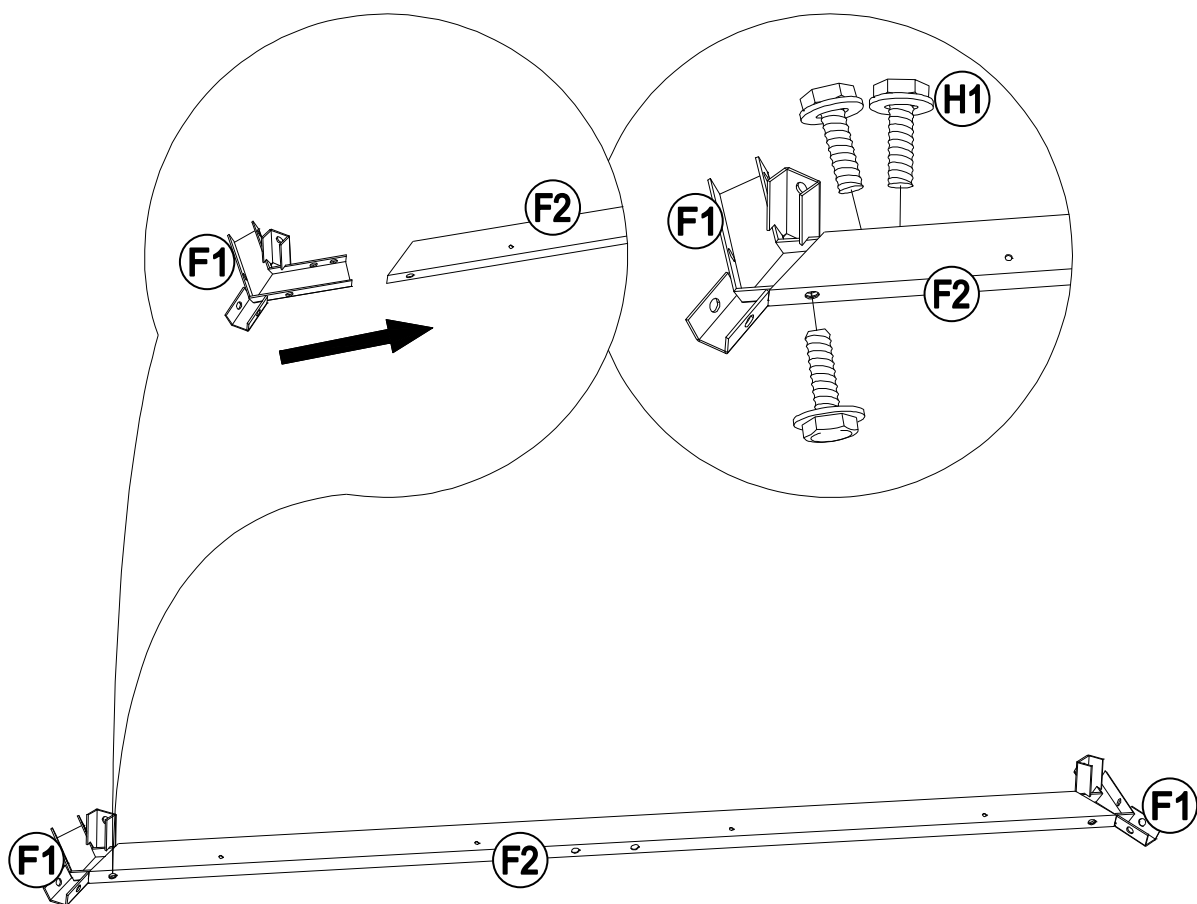
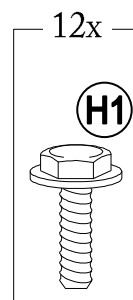
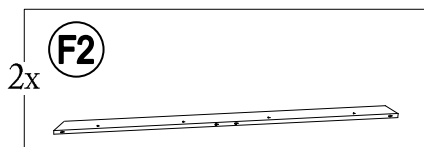
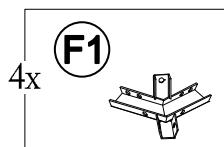

Note: When assembling this step, two people are required to hold the short tube of the large top frame (F2) to prevent deformation of the top frame.

# 9

Conseil: Quand vous assemblez cette étape, il vous faudra deux personnes pour tenir le tuyau court de la structure du grand toit (F2) pour éviter de déformer la structure du toit.

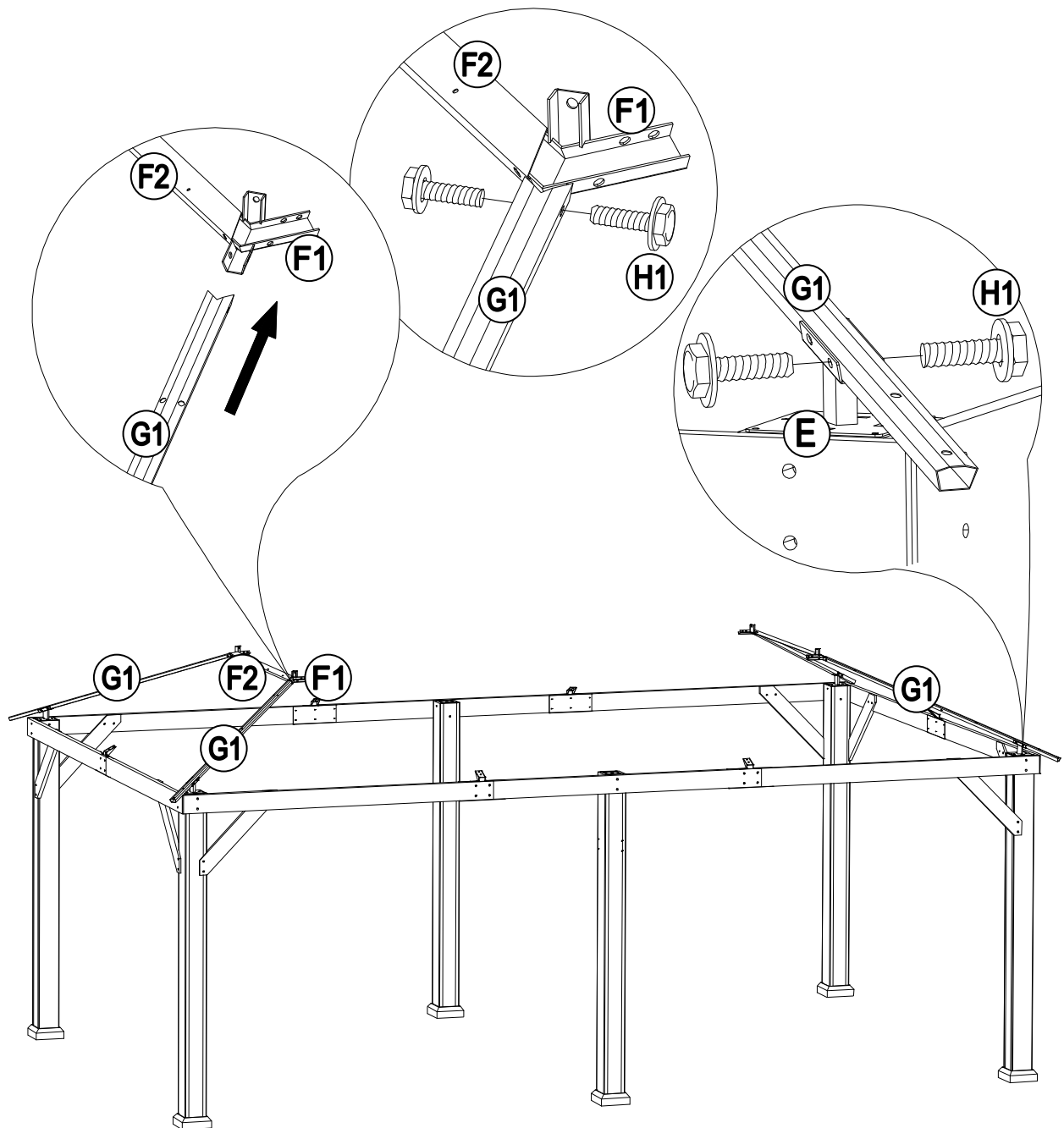
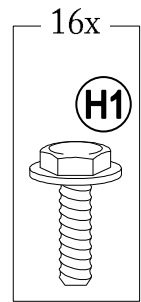
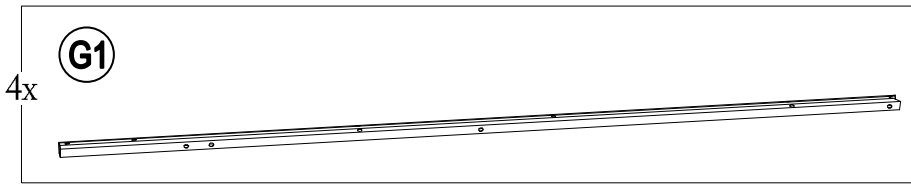

# 10

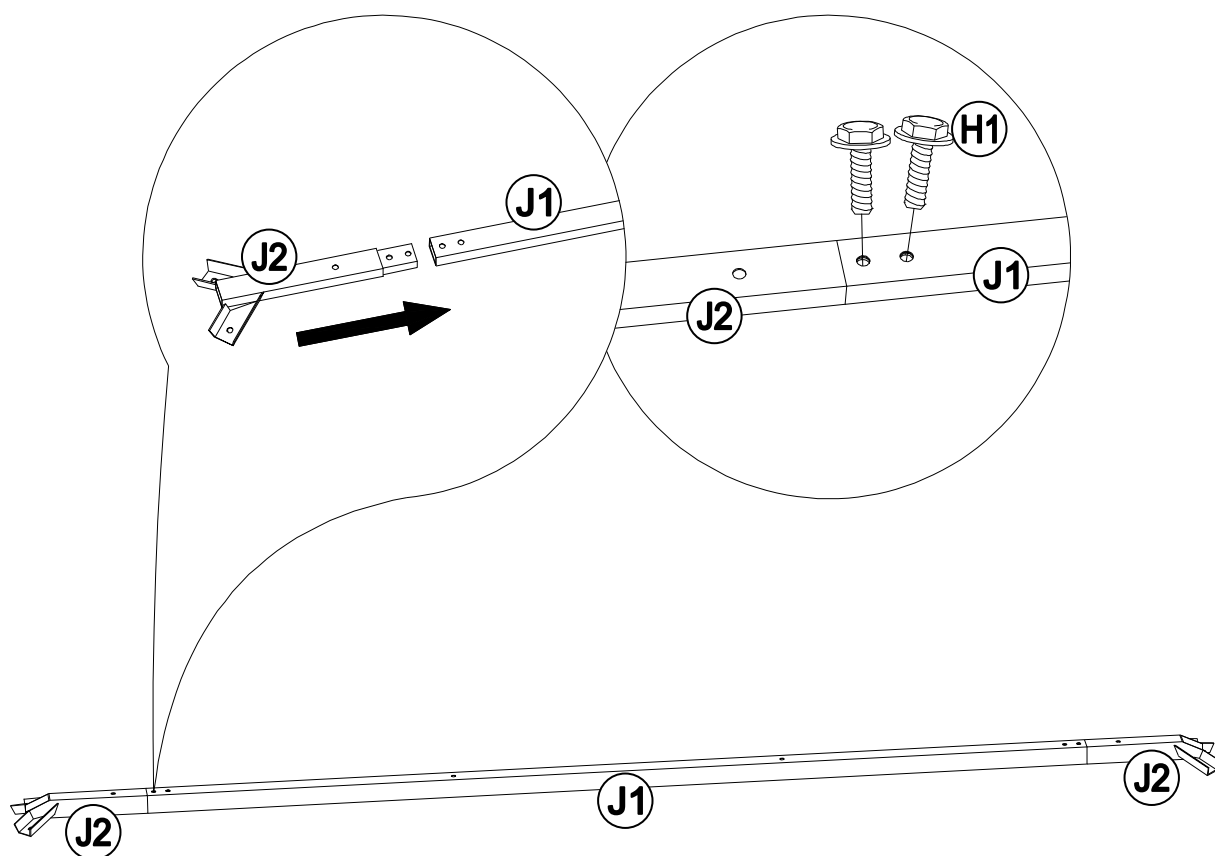
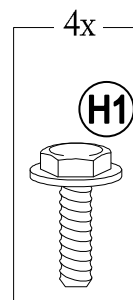
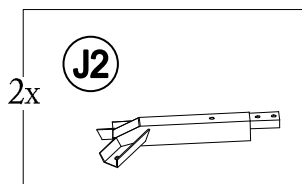
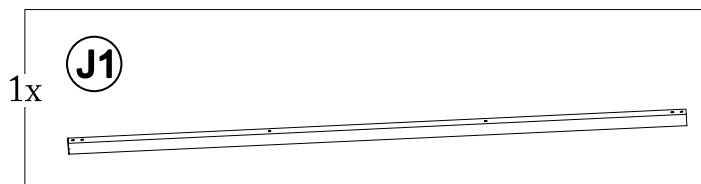

Note: When assembling this step, two people are required to hold the short tube of the large top frame (F2) to prevent deformation of the top frame.

# 11

Conseil: Quand vous assemblez cette étape, il vous faudra deux personnes pour tenir le tuyau court de la structure du grand toit (F2) pour éviter de déformer la structure du toit.

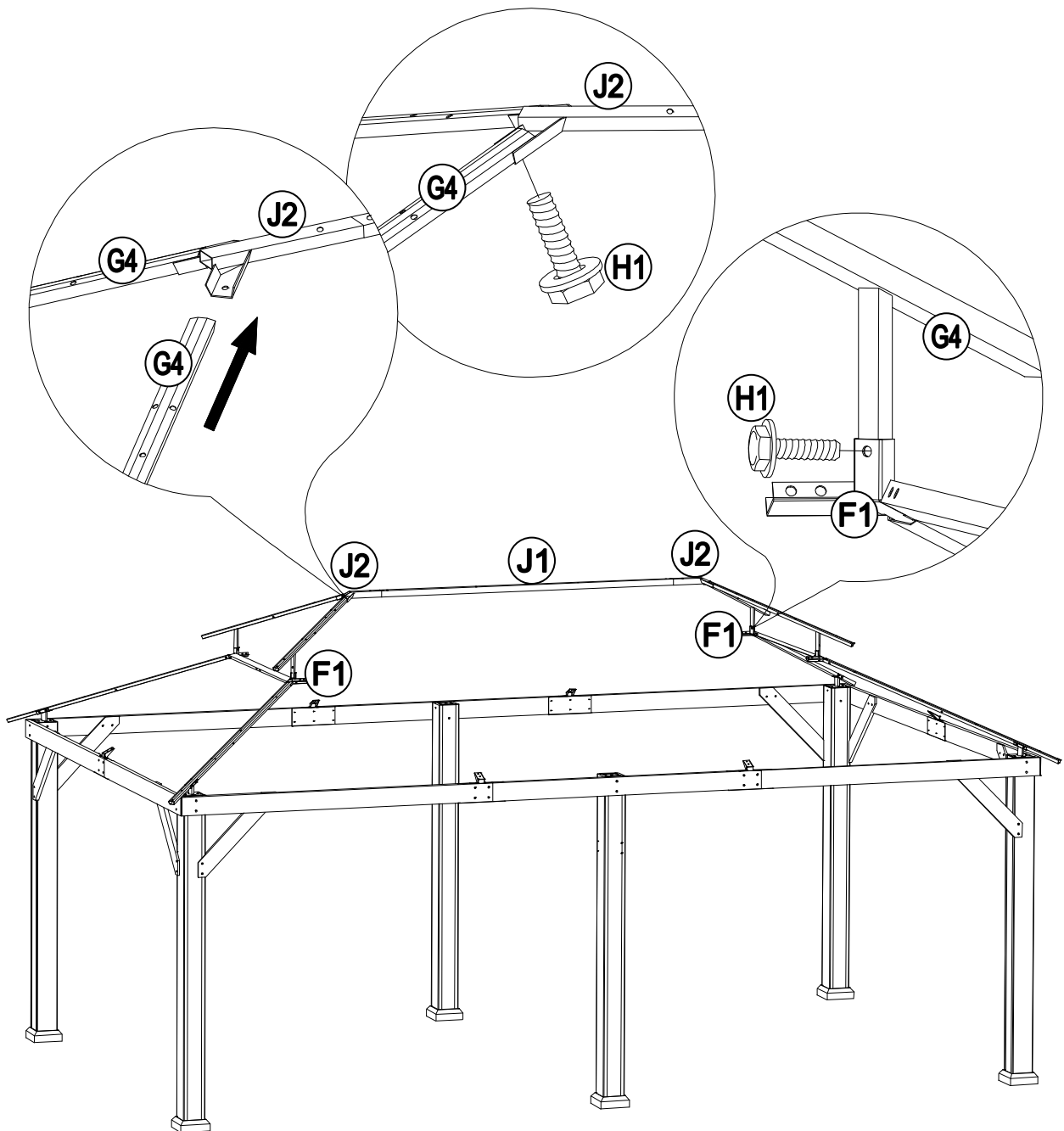
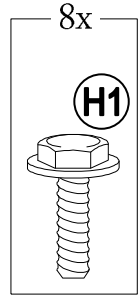
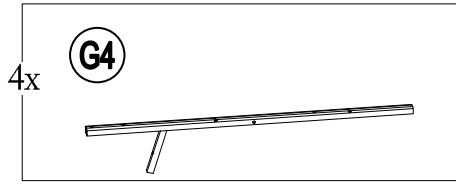

# 12

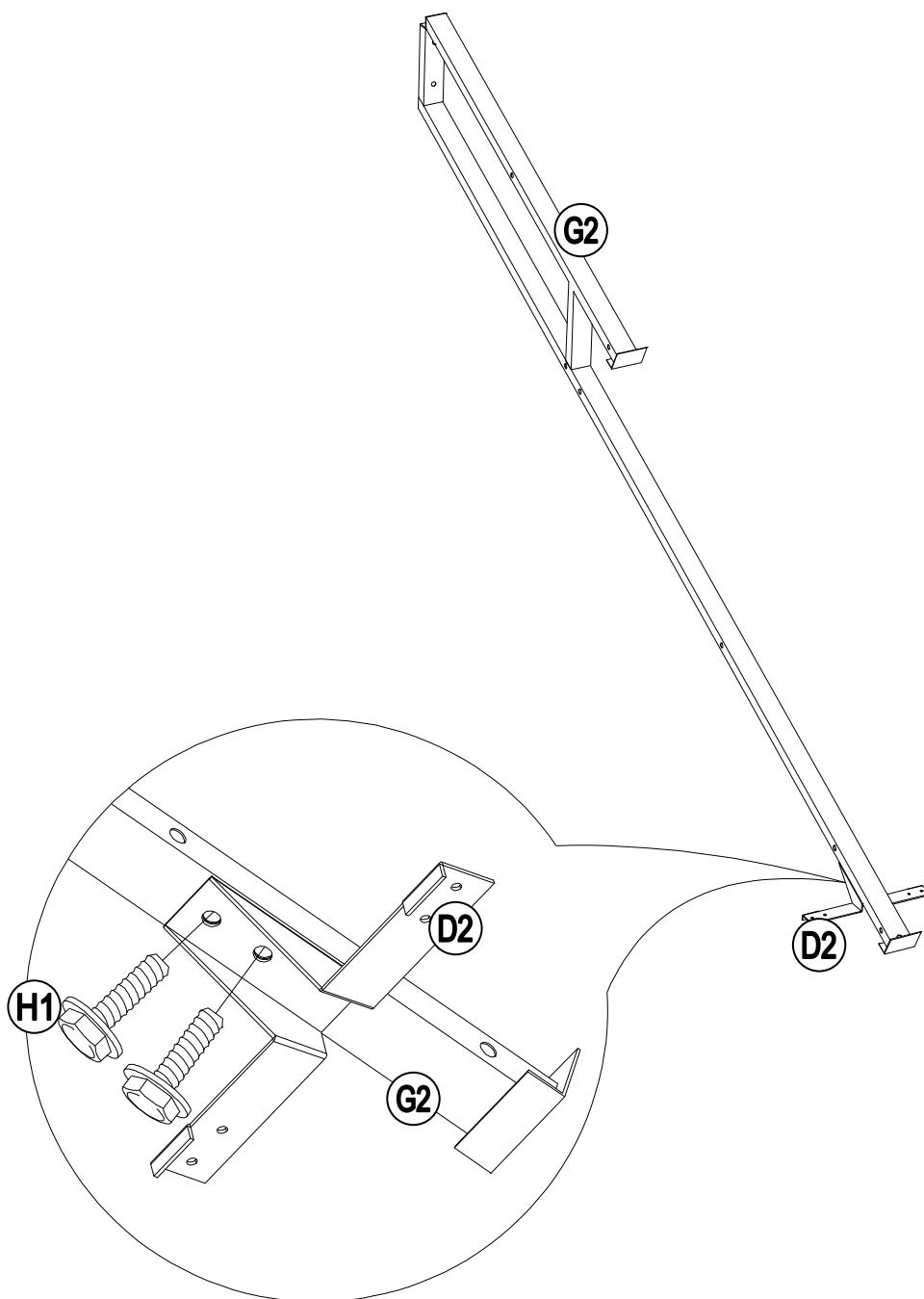
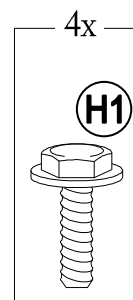
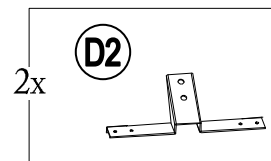
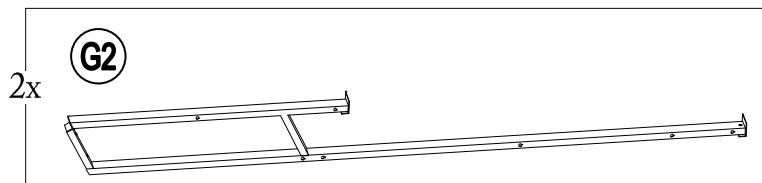

Note: When assembling this step, two people are required to hold the short tube of the large top frame (F2) to prevent deformation of the top frame.

# 13

Conseil: Quand vous assemblez cette étape, il vous faudra deux personnes pour tenir le tuyau court de la structure du grand toit (F2) pour éviter de déformer la structure du toit.

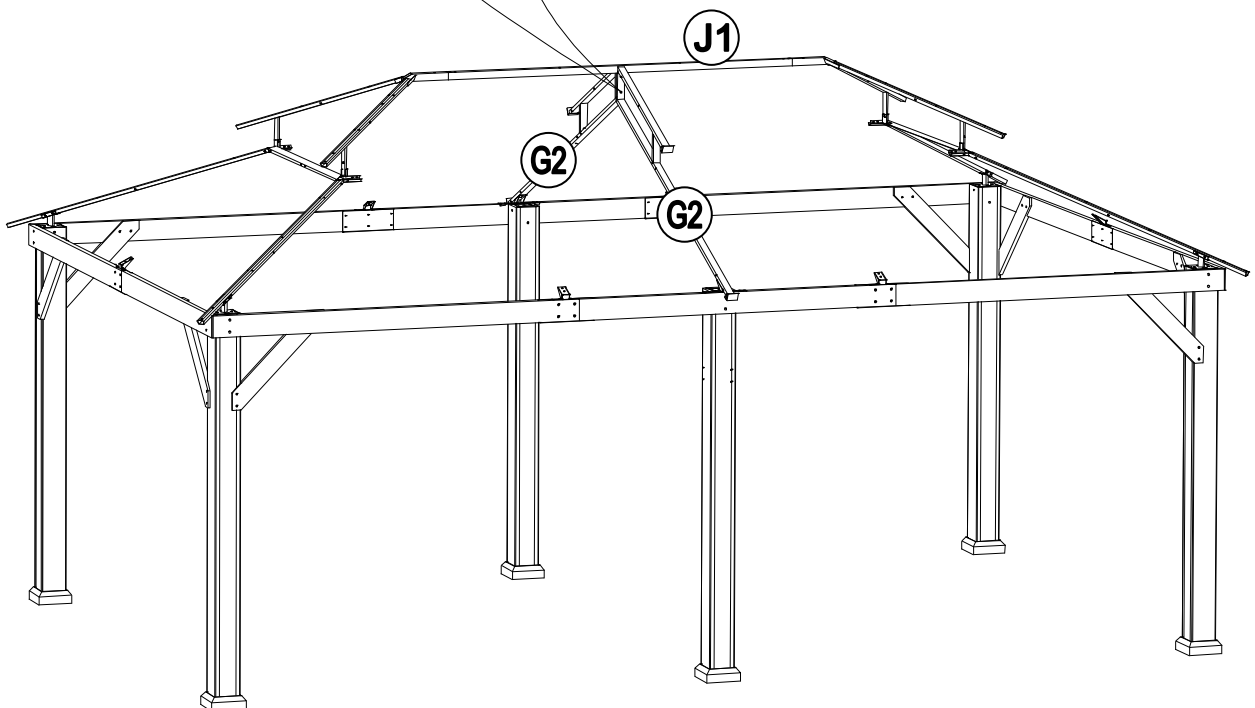
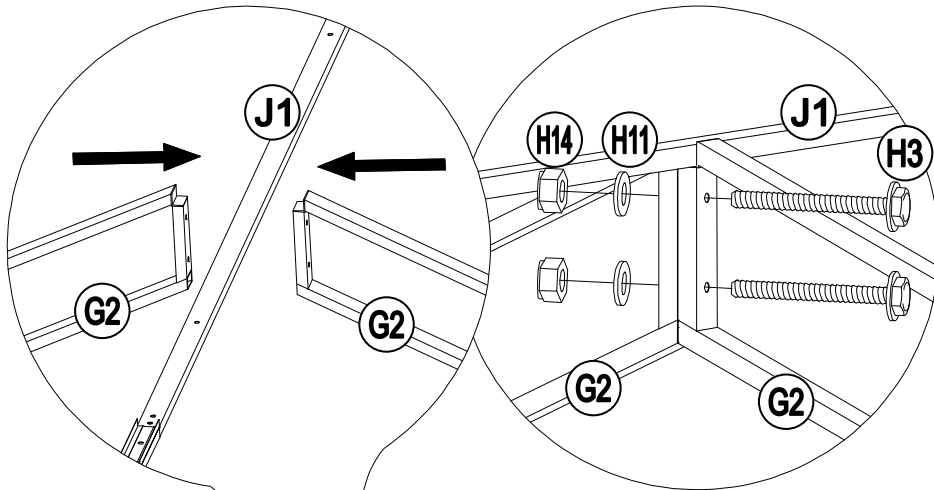
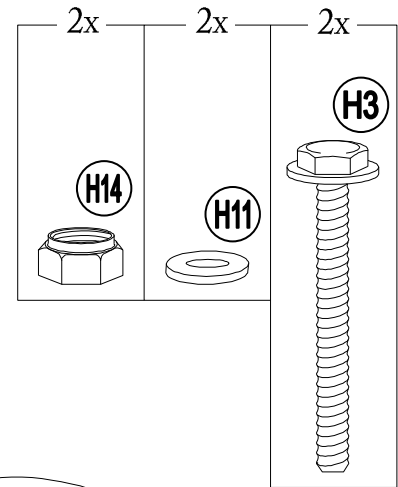

Note: When assembling this step, two people are required to hold the short tube of the large top frame (F2) to prevent deformation of the top frame.

# 14

Conseil: Quand vous assemblez cette étape, il vous faudra deux personnes pour tenir le tuyau court de la structure du grand toit (F2) pour éviter de déformer la structure du toit.

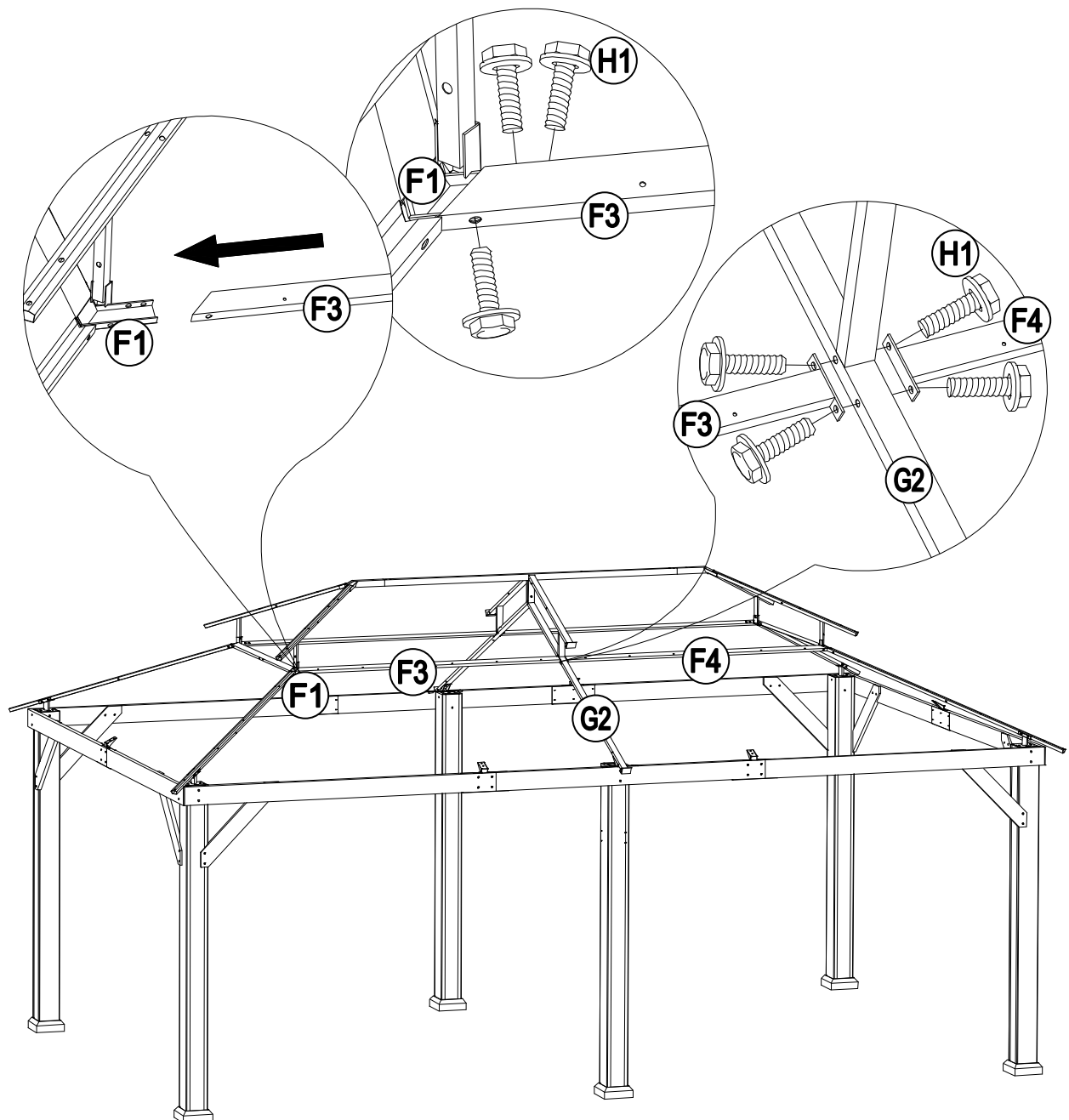
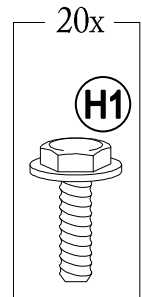
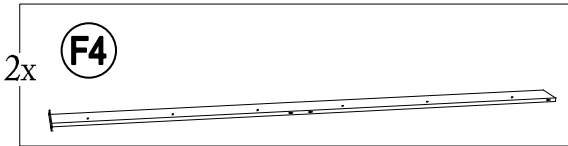
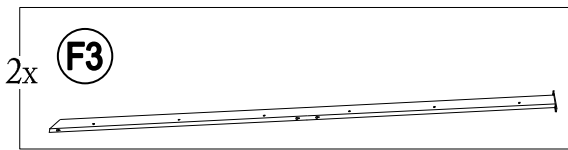



# 15

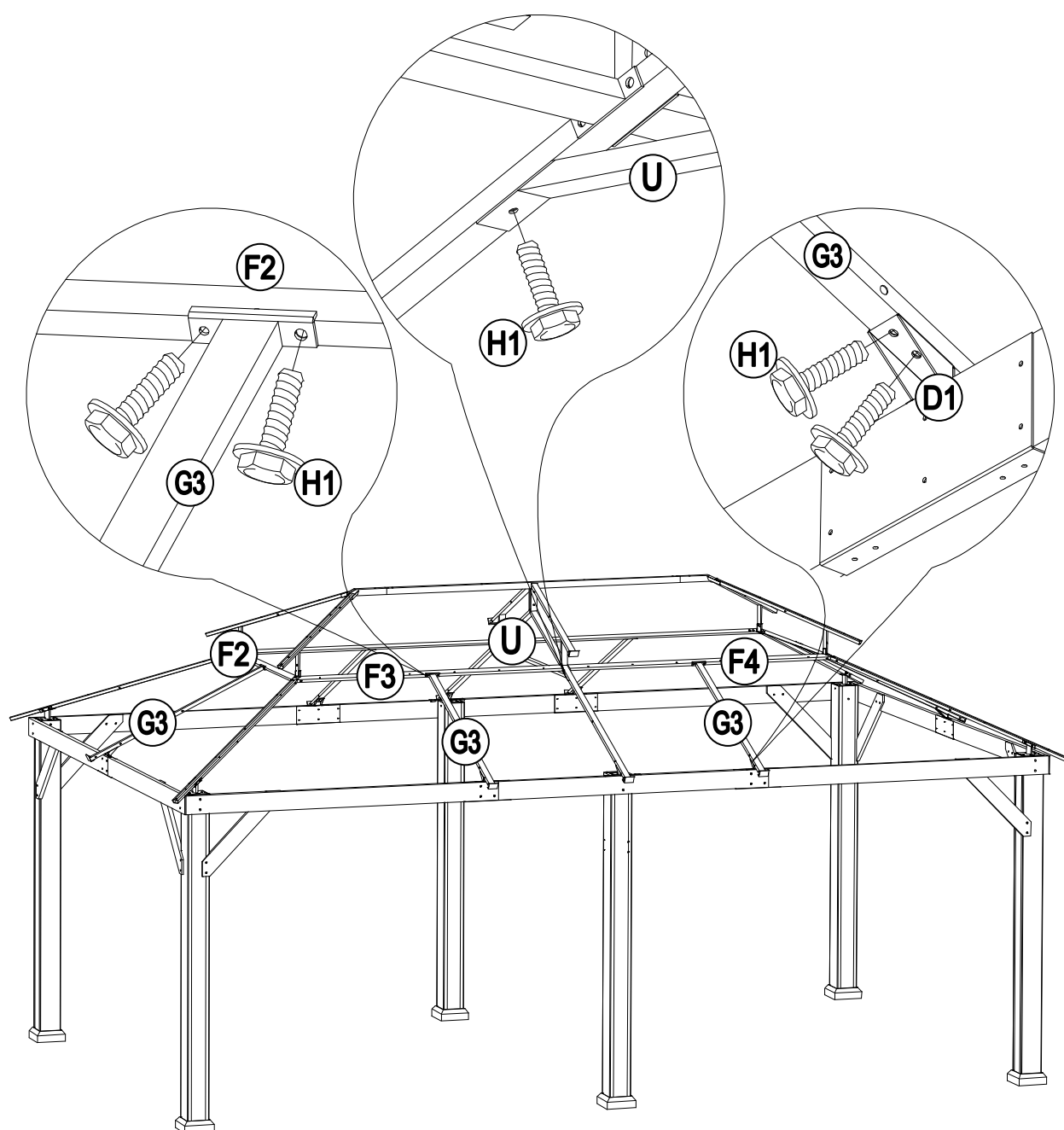
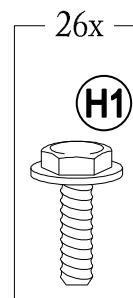
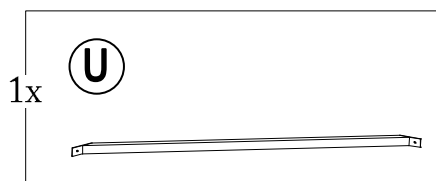
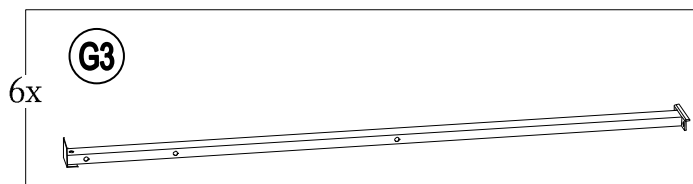

# 16

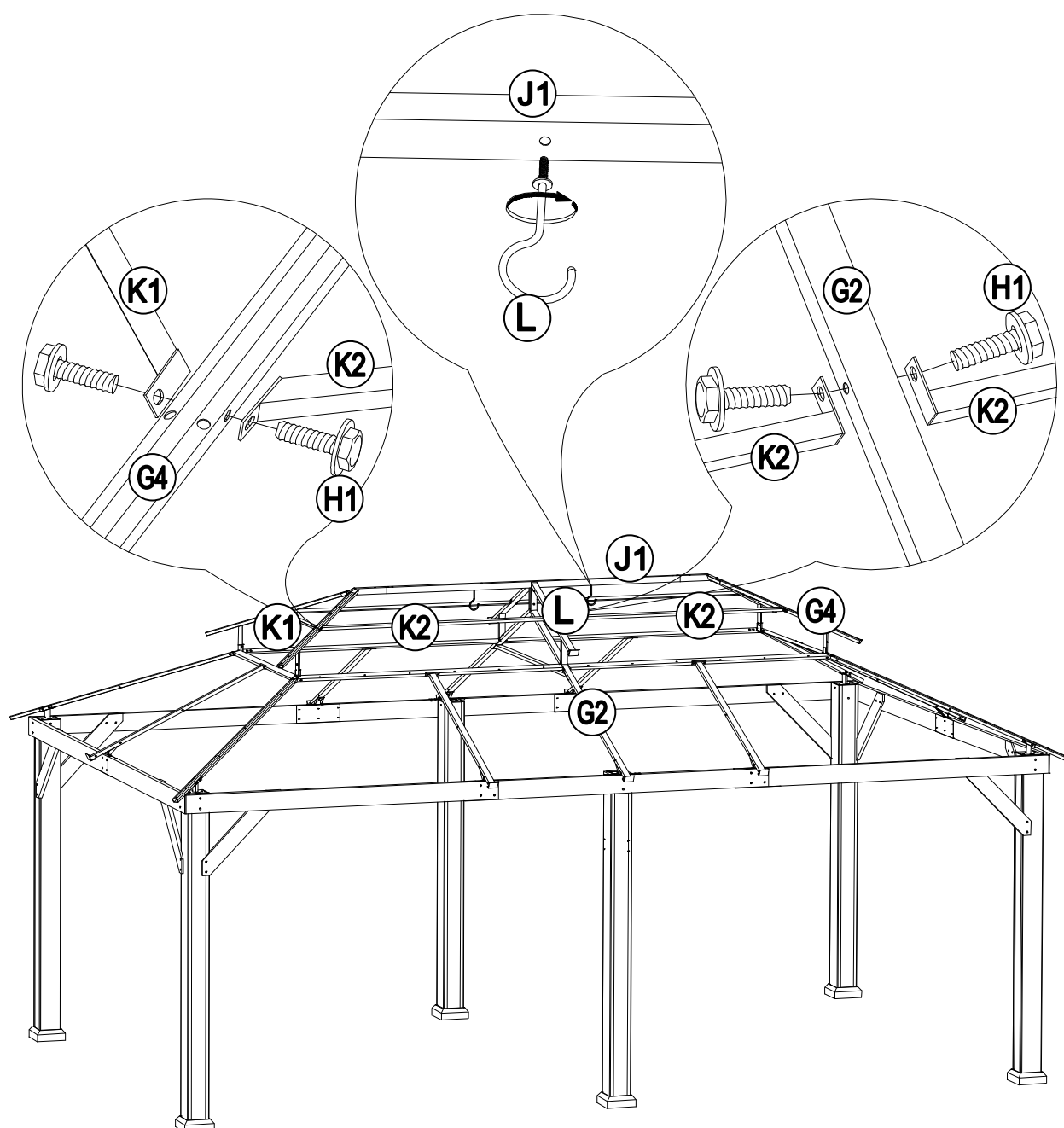
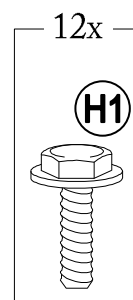
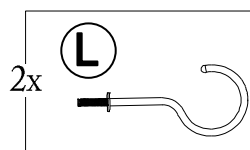
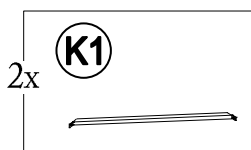

# 17

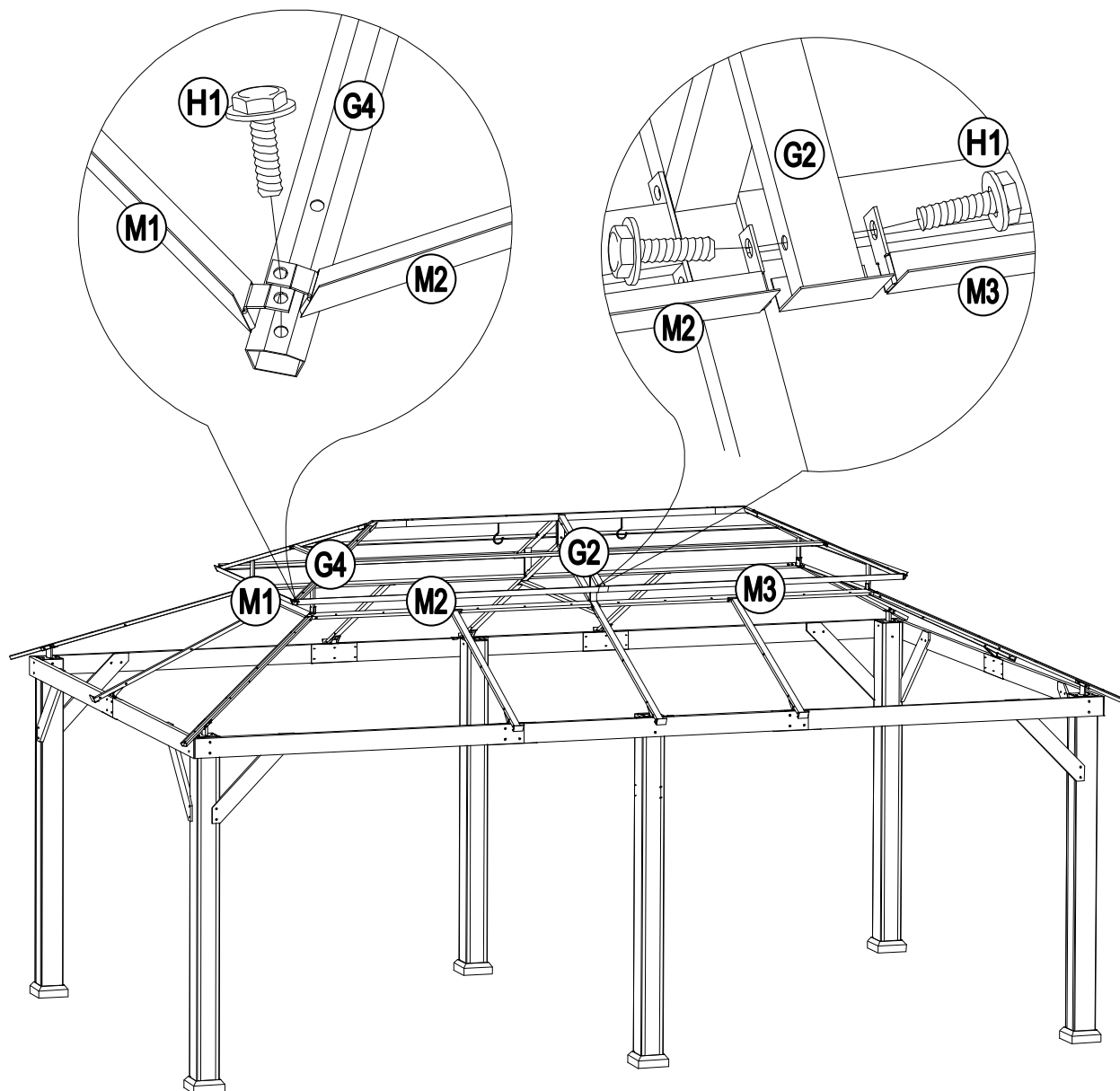
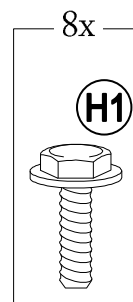
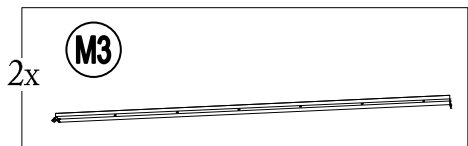
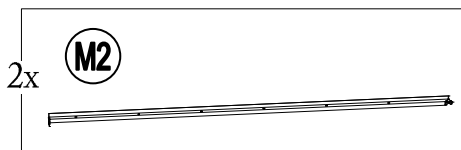
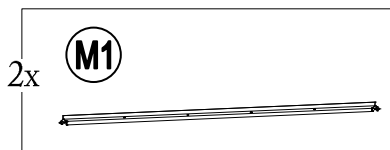

# 18

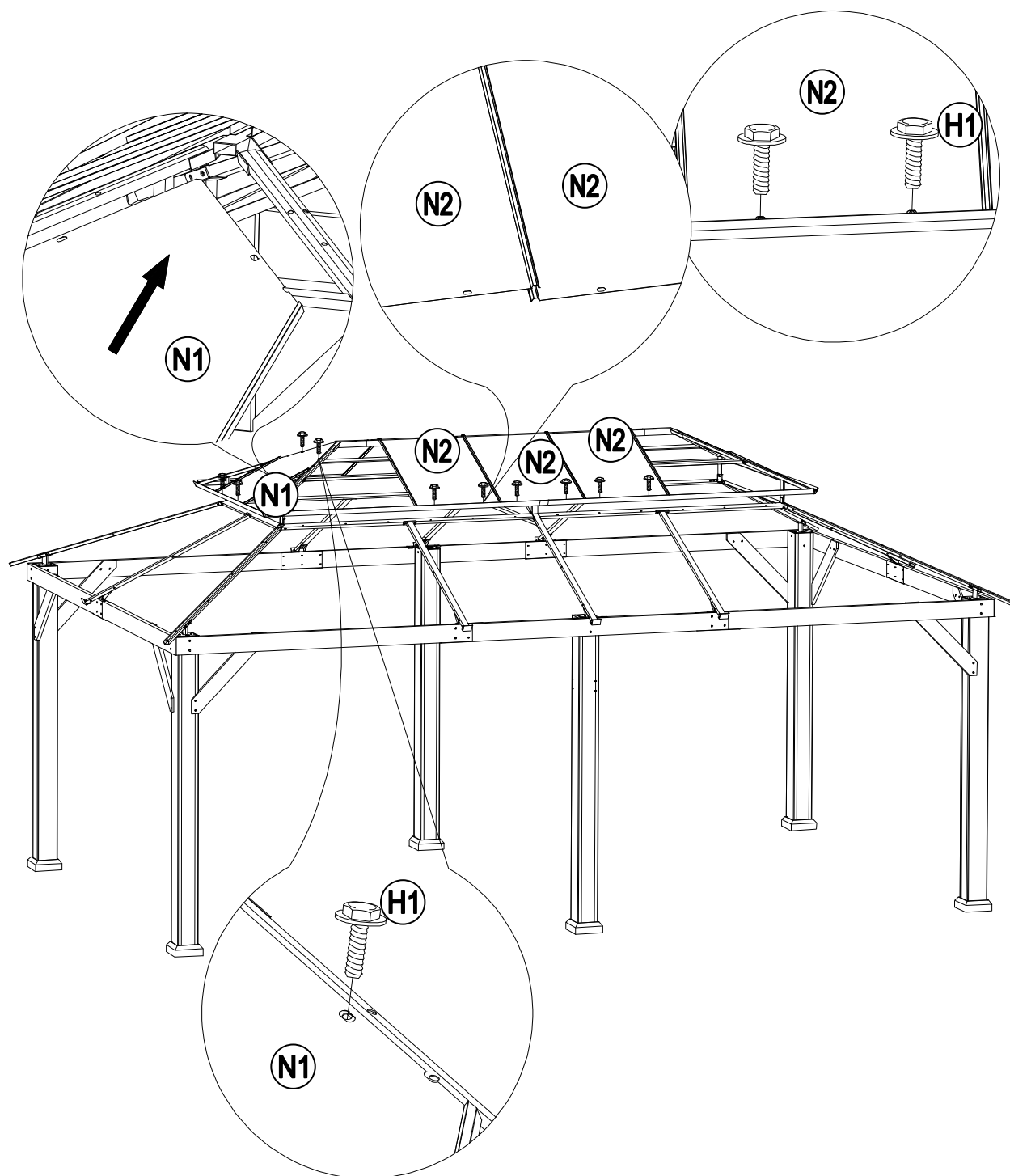
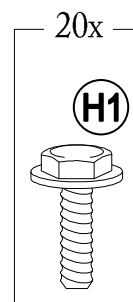
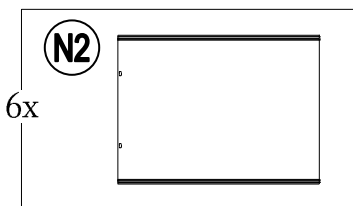
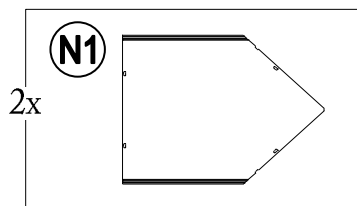

# 19

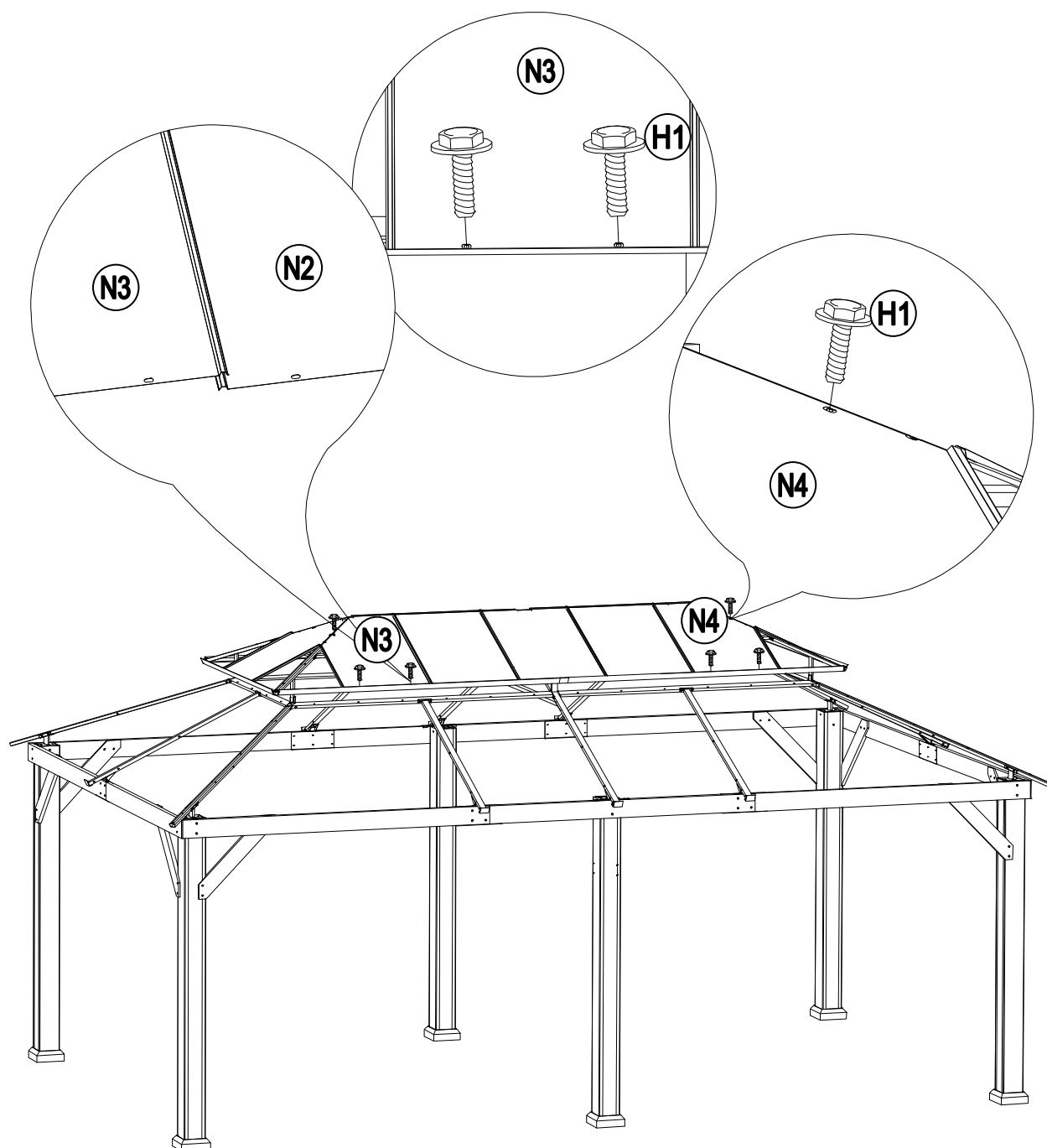
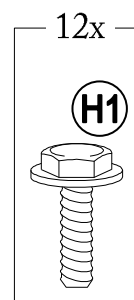
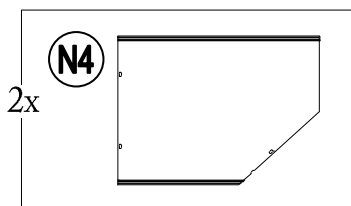
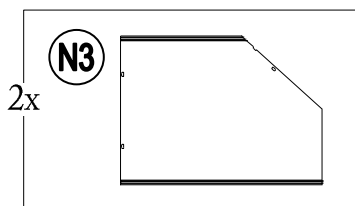

# 20

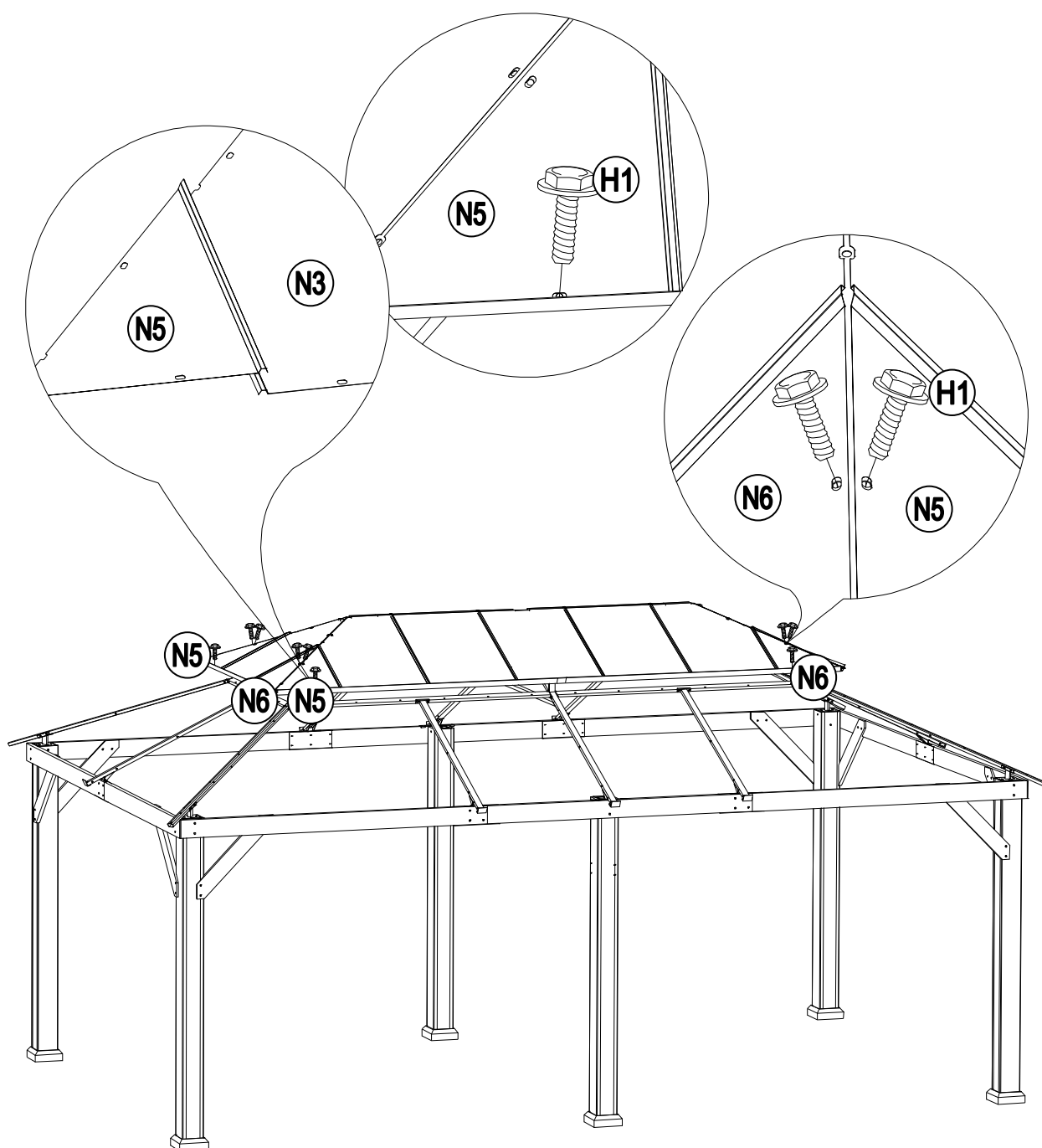
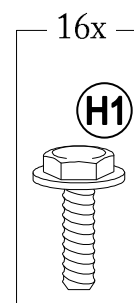
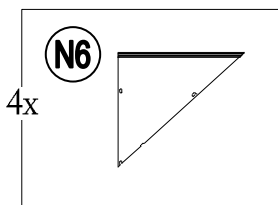
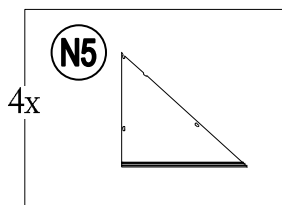

# 21

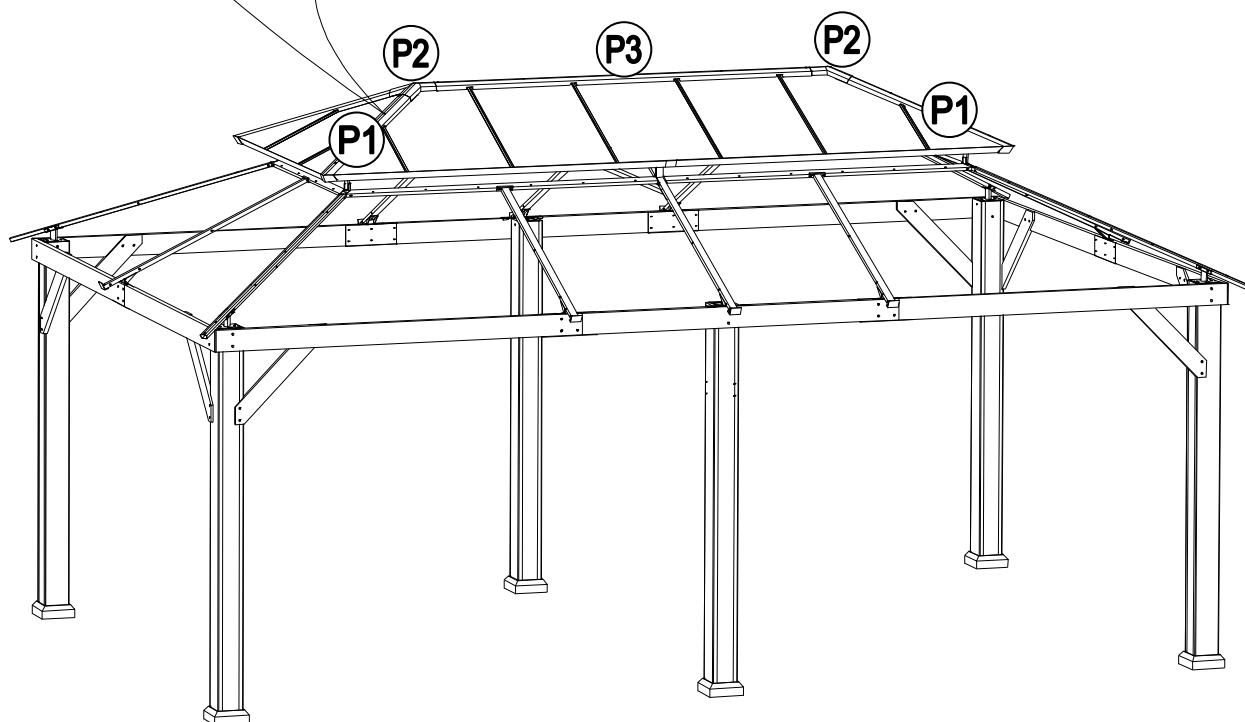
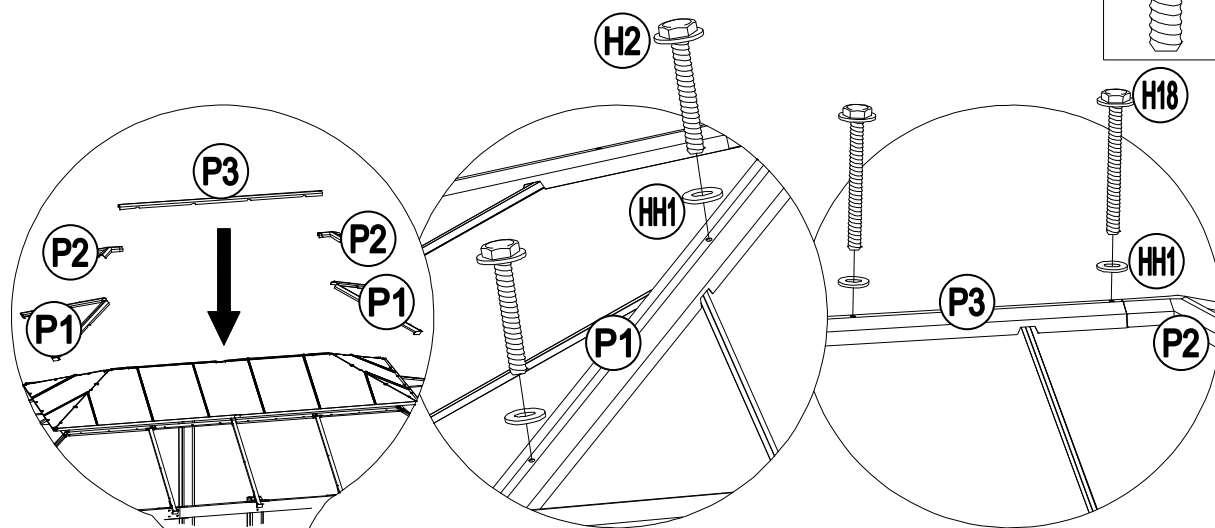
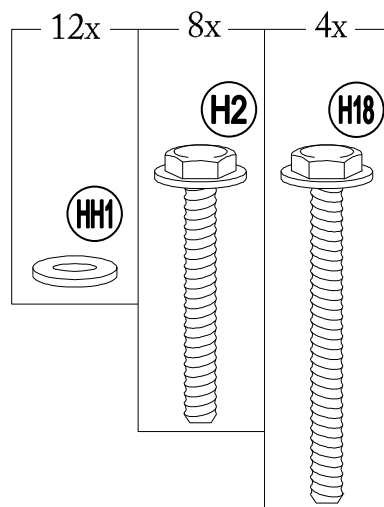
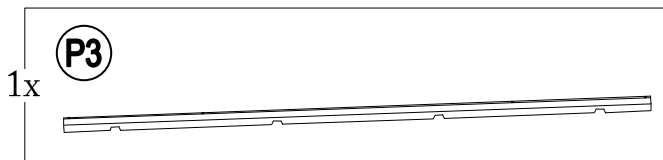
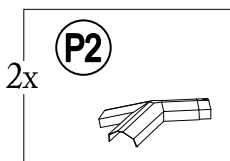
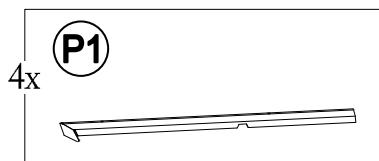

# 22

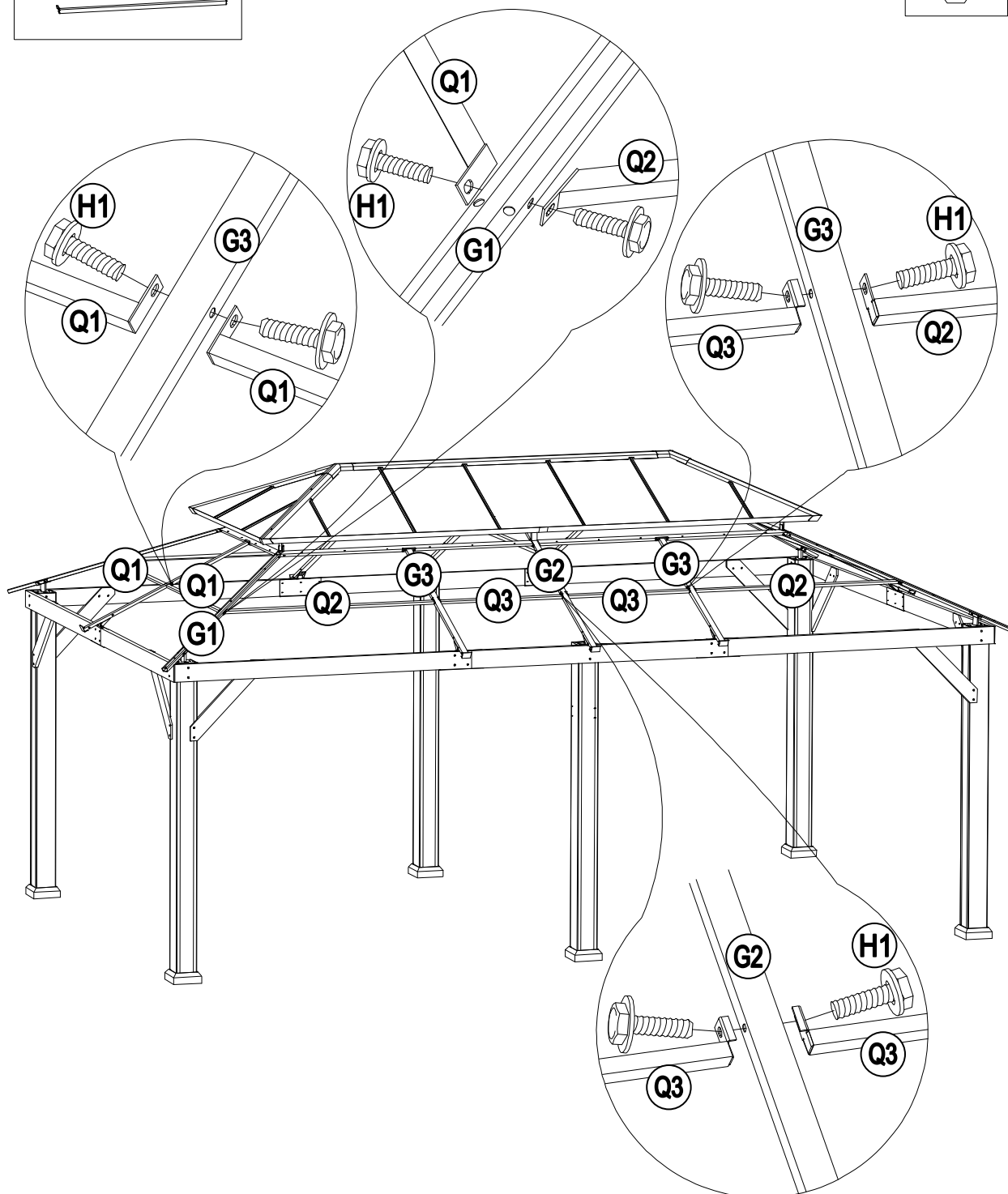
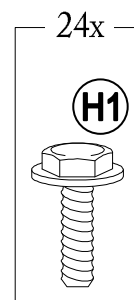
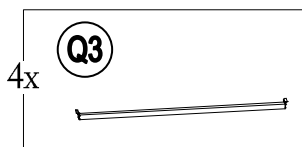
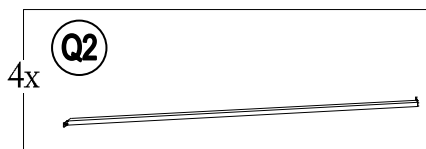
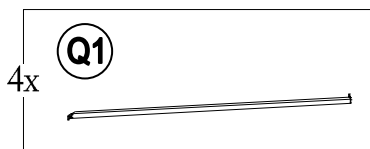



# 23

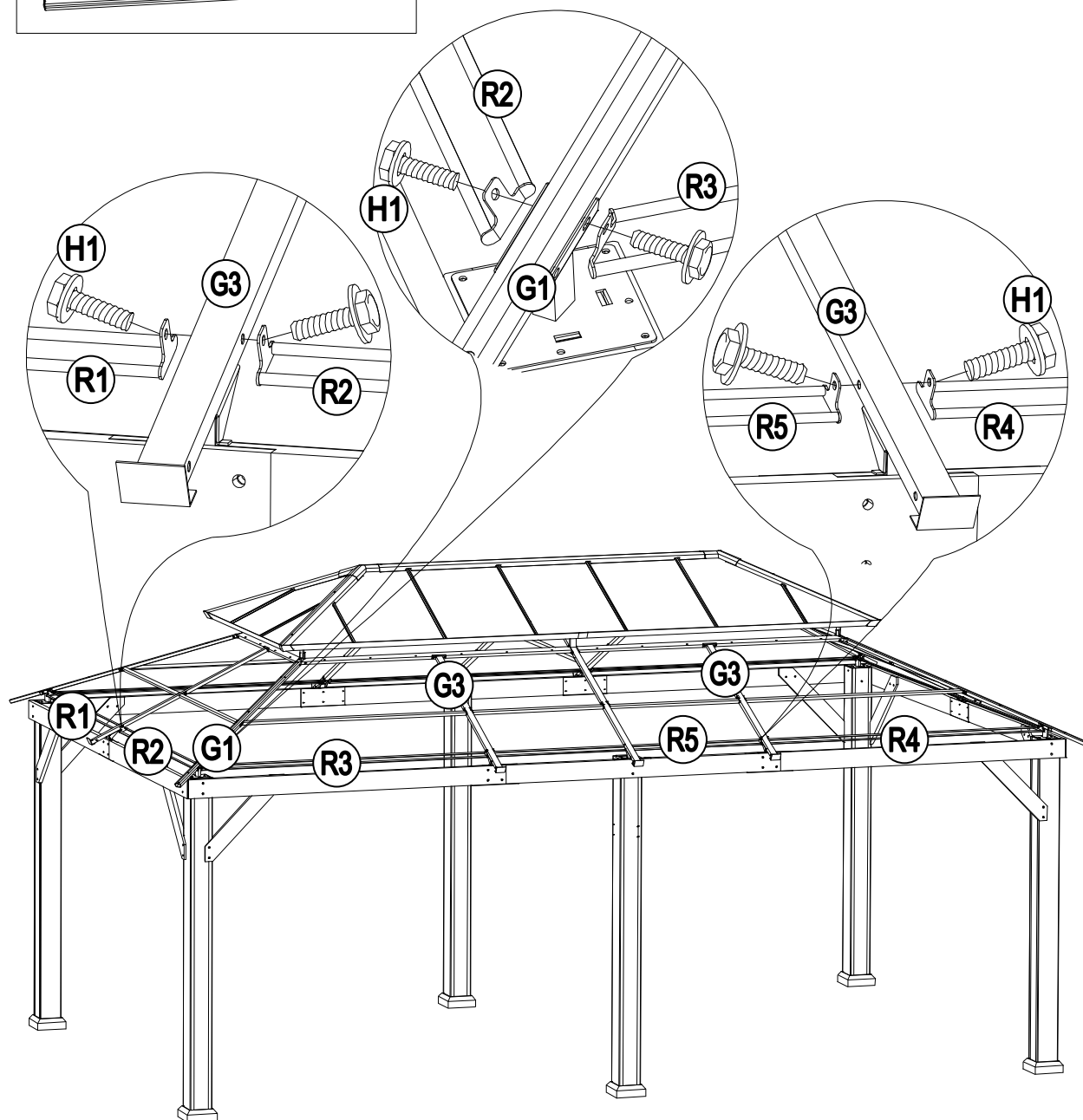
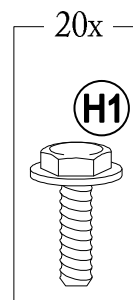
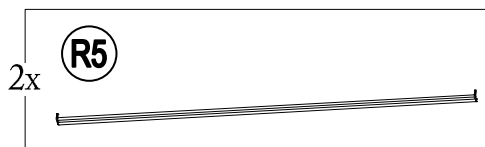
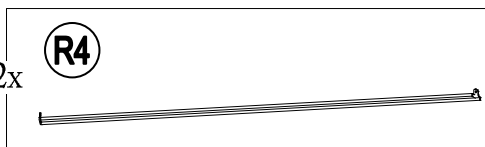
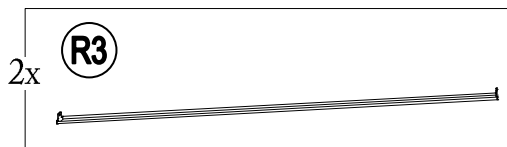
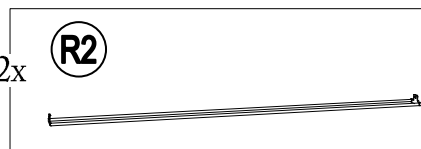
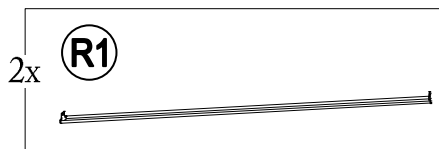

# 24

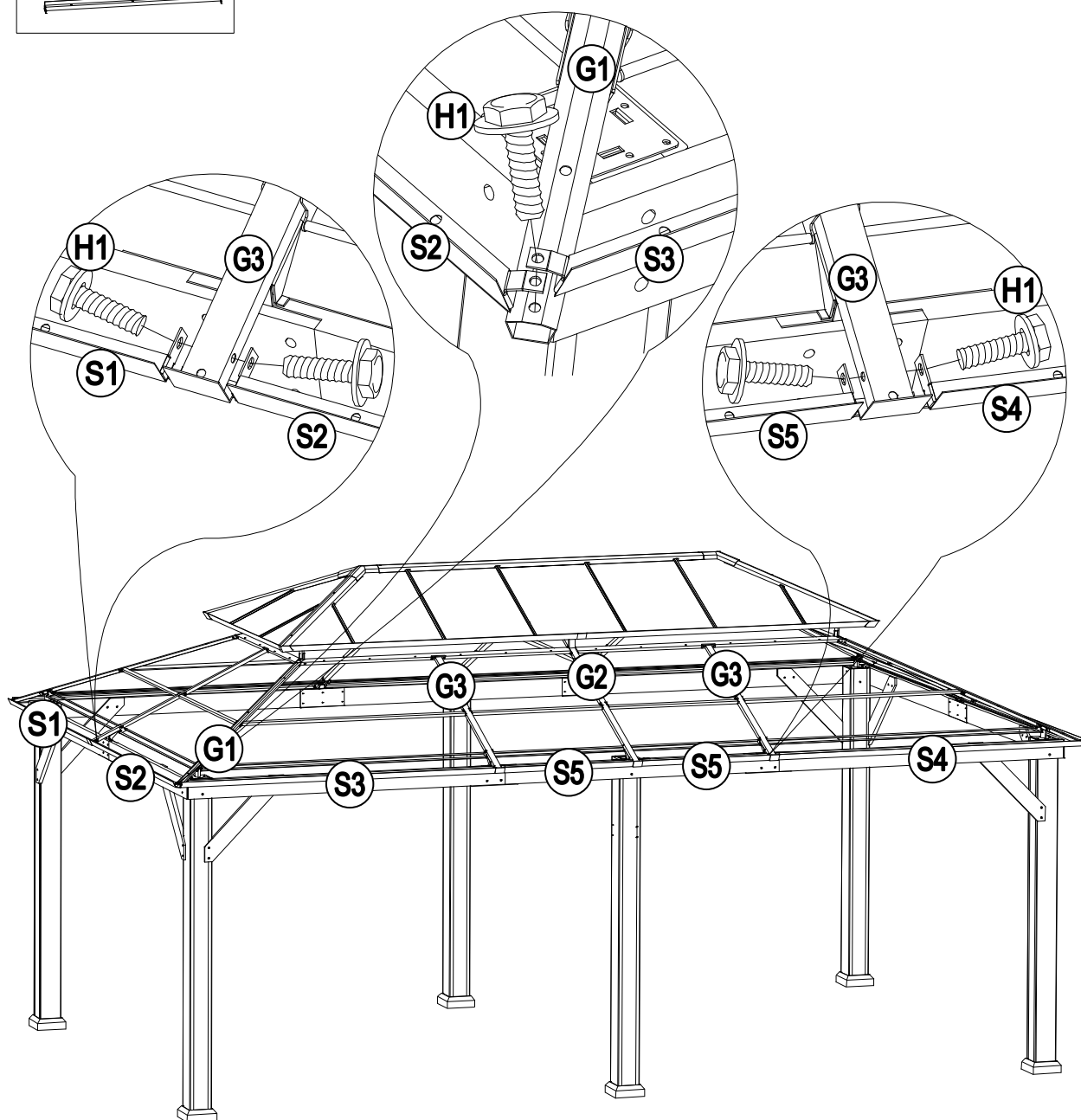
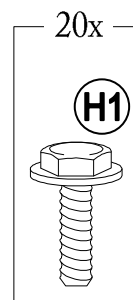
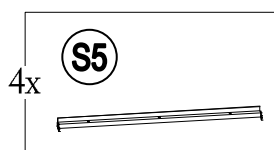
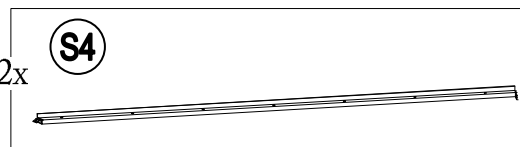
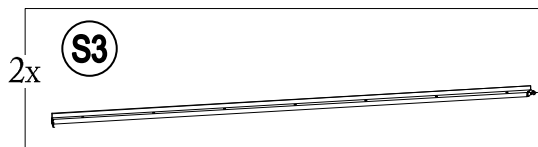
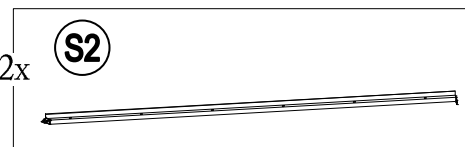
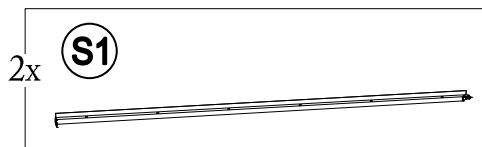

# 25

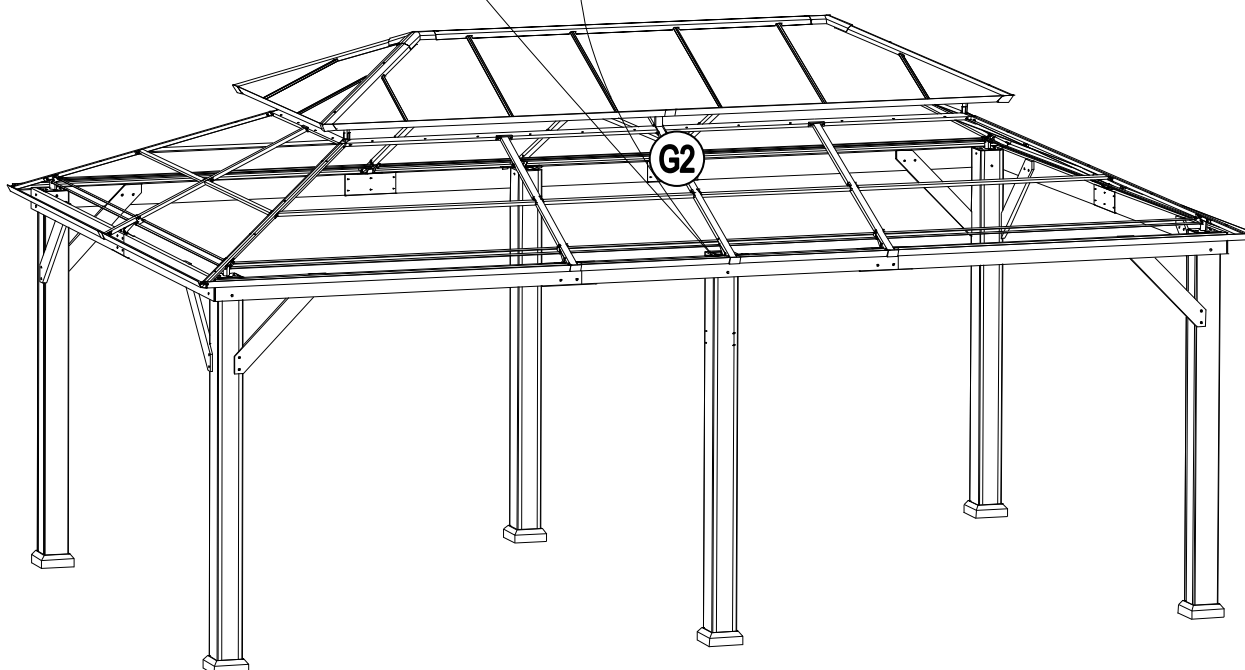
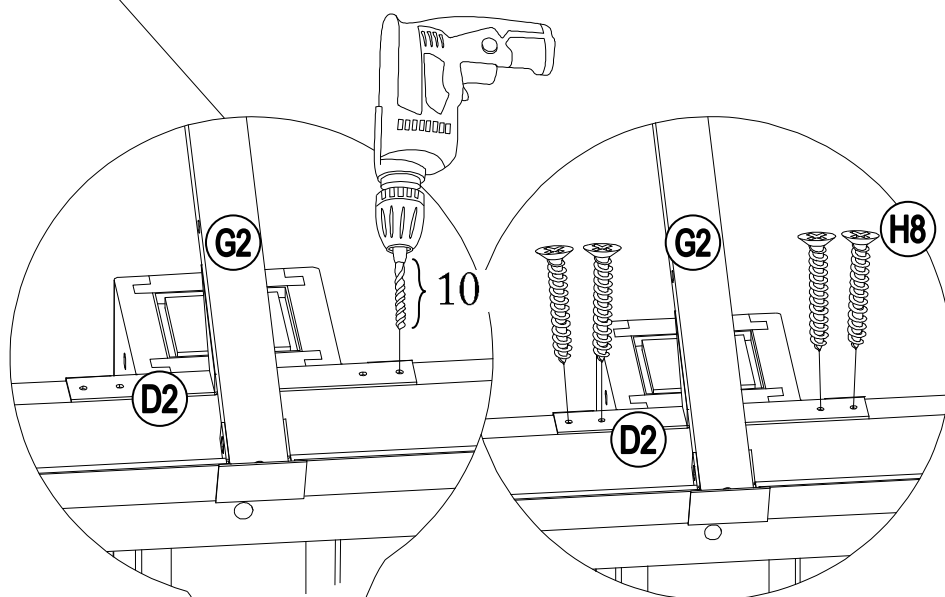
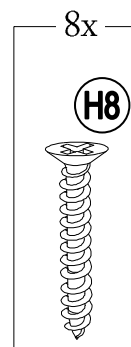
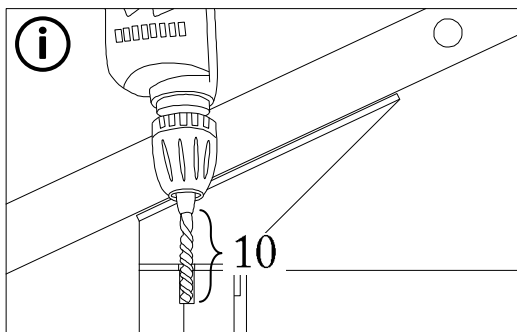

# 26

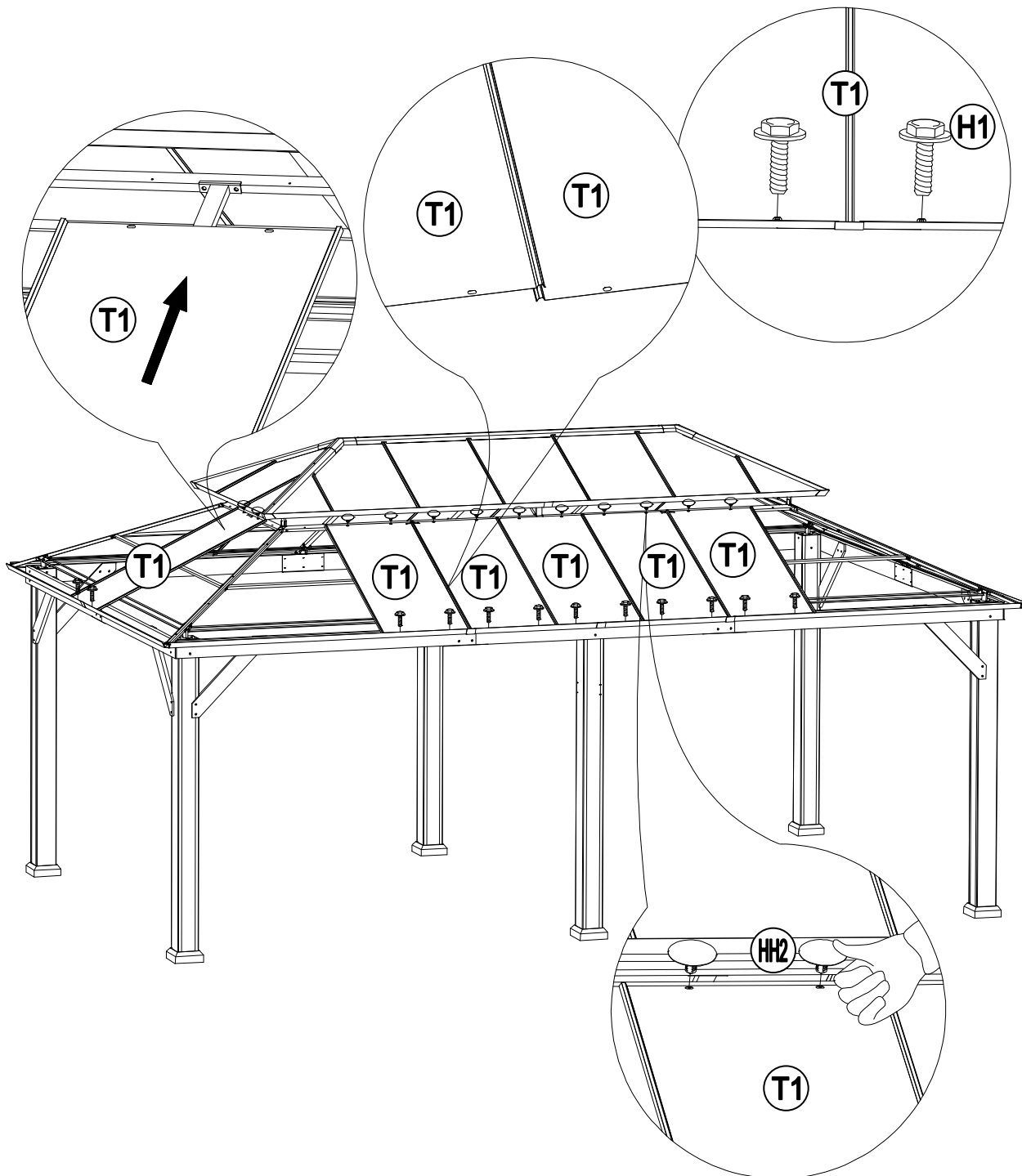
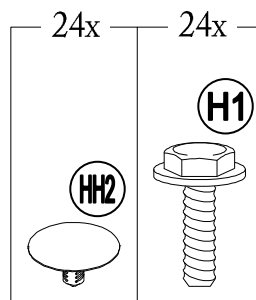
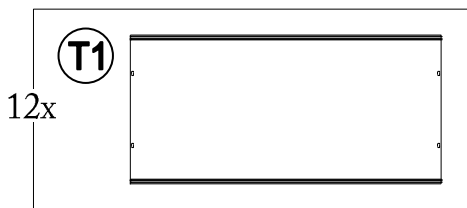

# 27

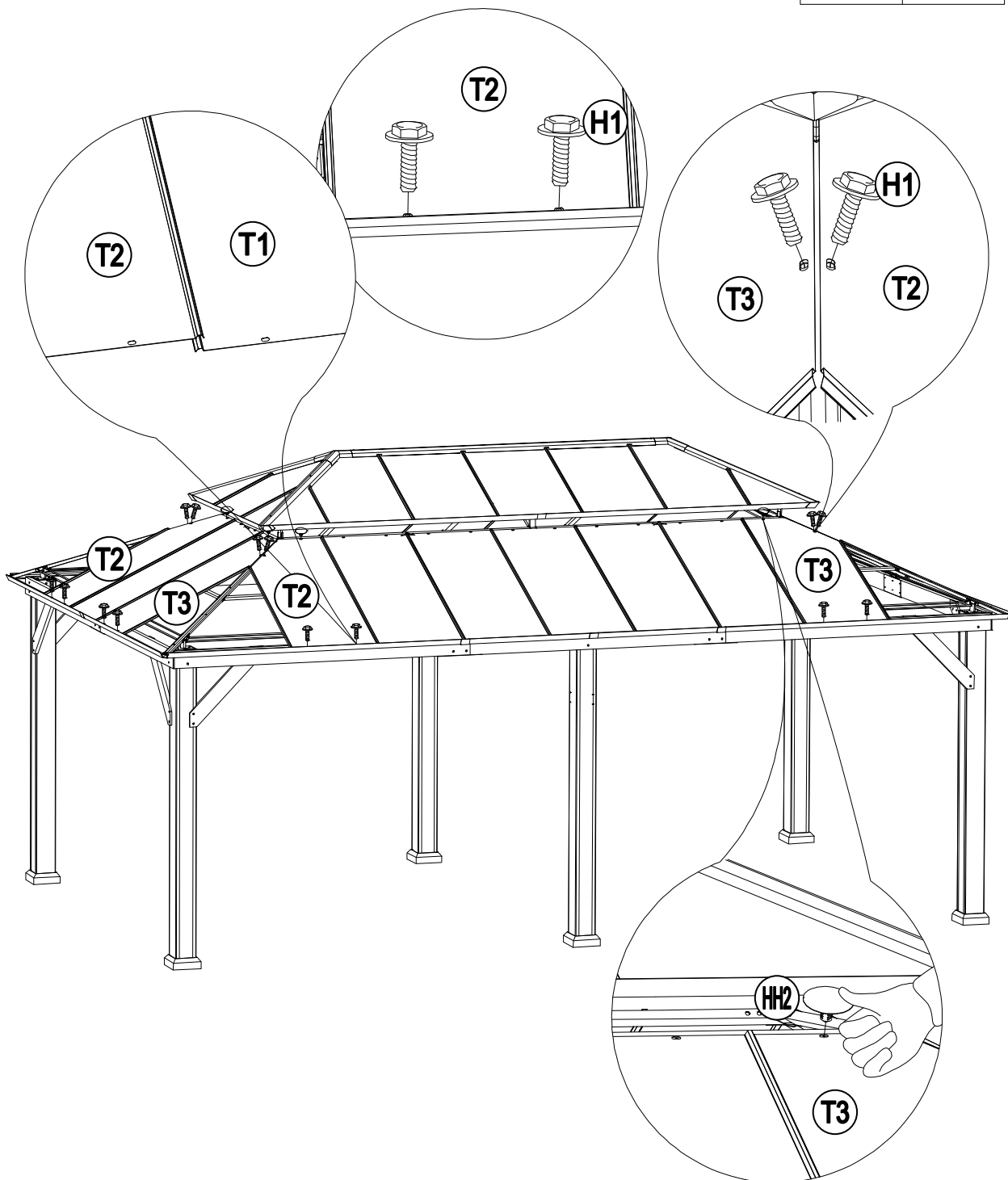
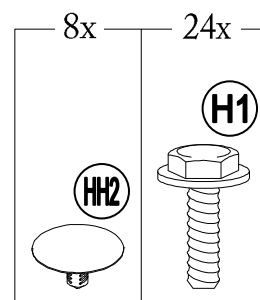
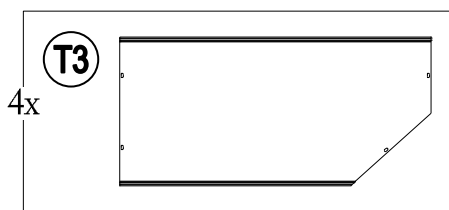
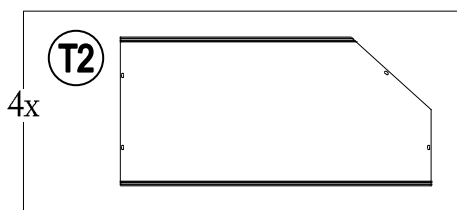

# 28

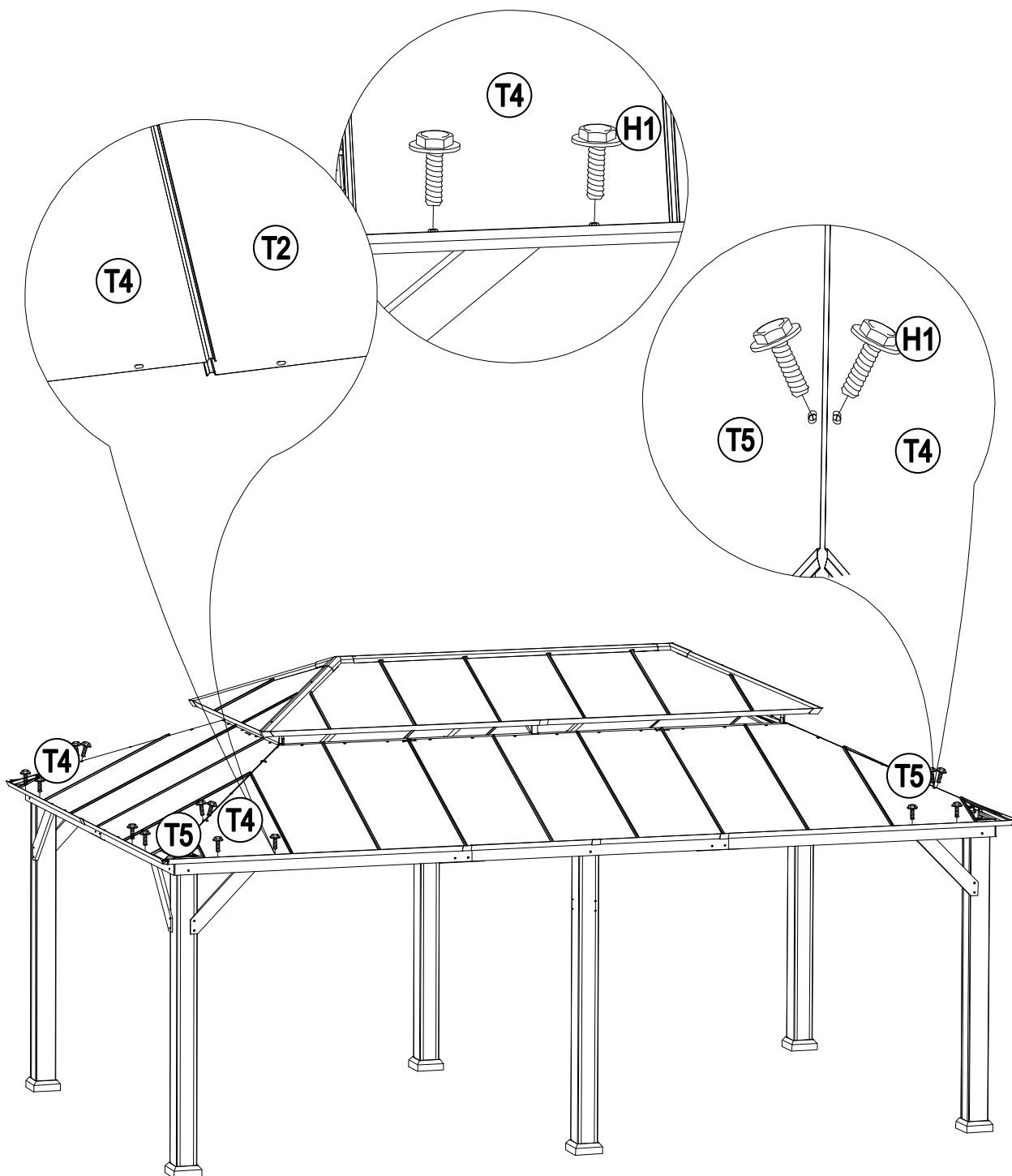
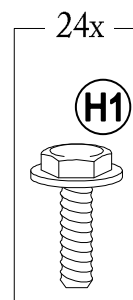
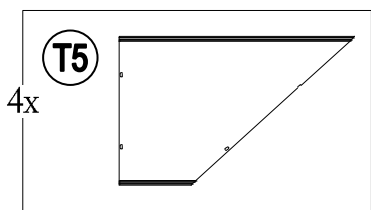
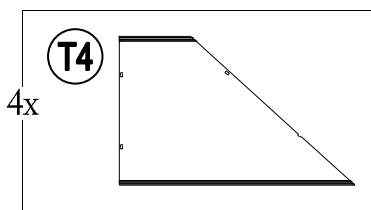

# 29

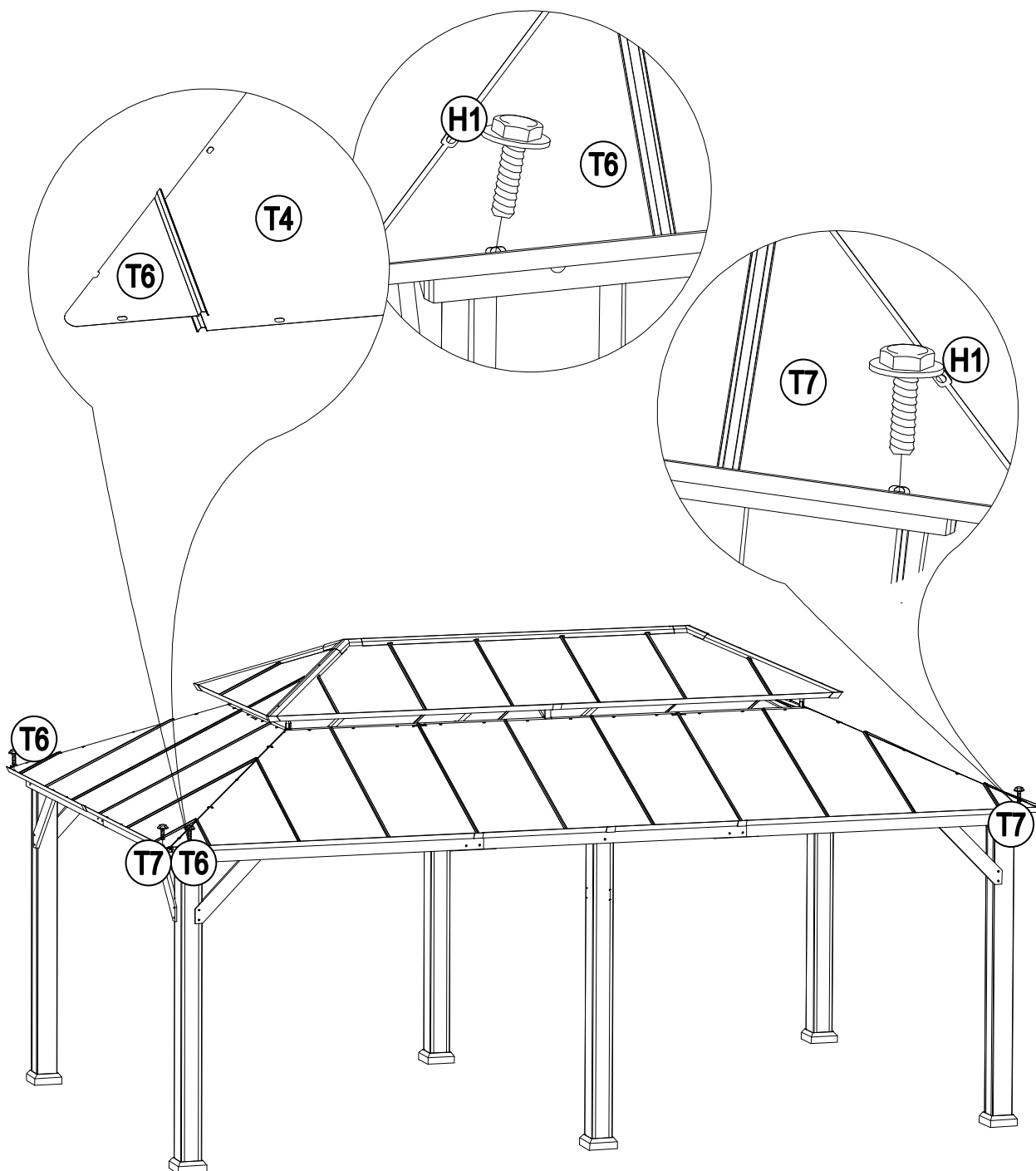
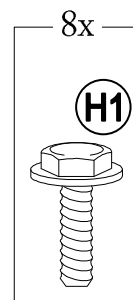
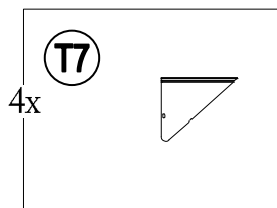
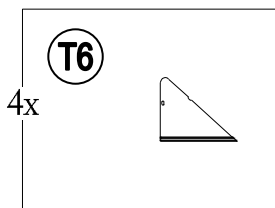

# 30

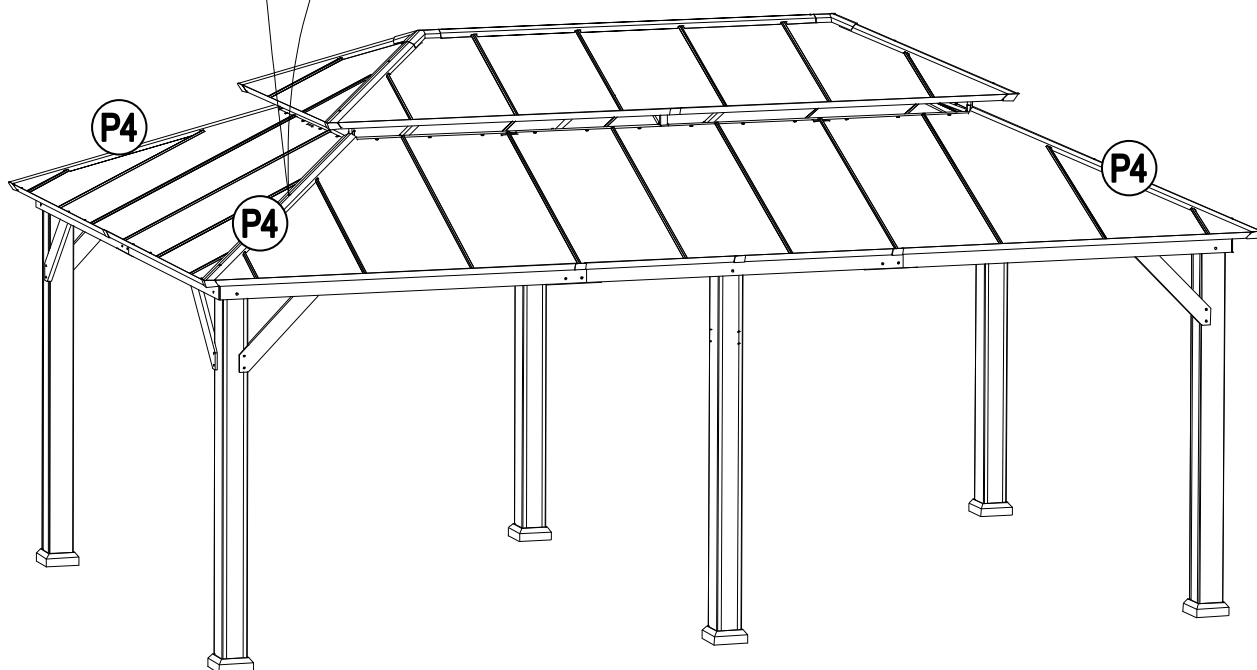
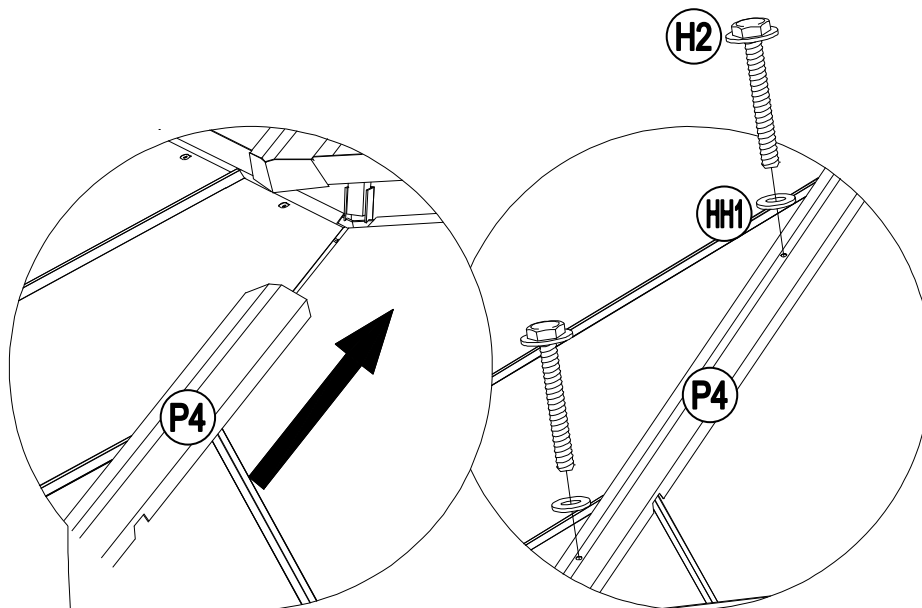
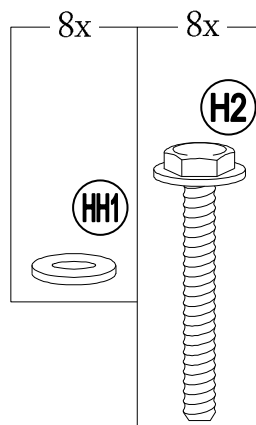
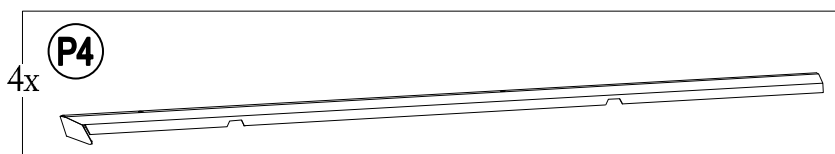



# 31

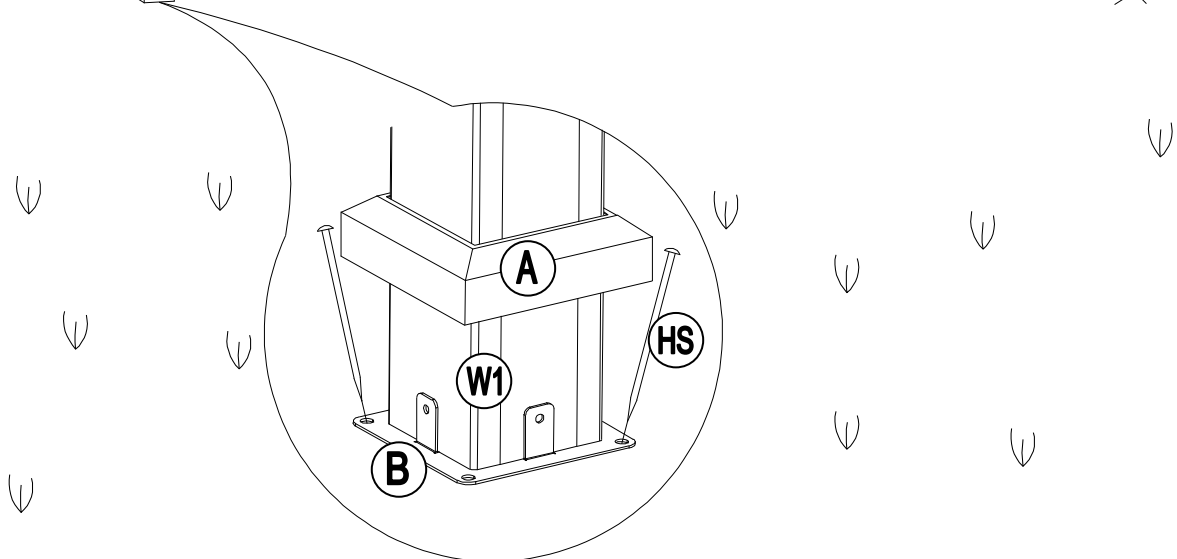
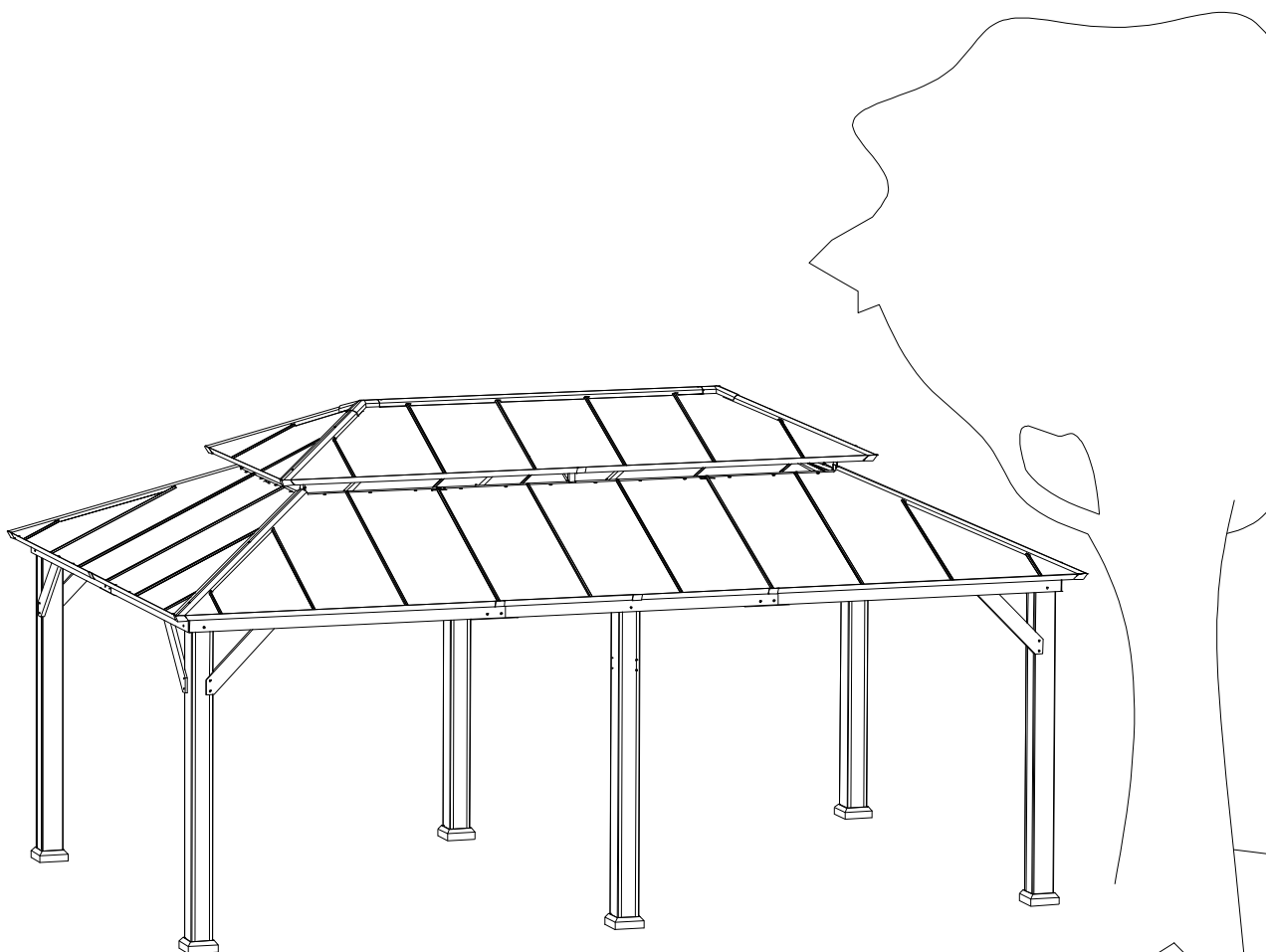
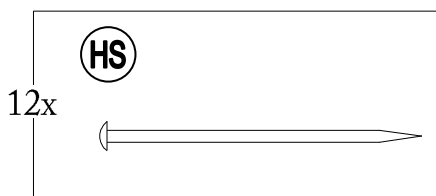

# WOOD CARE GUIDELINES

Wood requires some care and attention over its lifetime to ensure a long-lasting beautiful finish. Proper cleaning and maintenance will keep your wood products looking beautiful for a long time. Please follow these guidelines to maintain your wood surfaces.

- **Fading and weathering:** Wood is a natural product and is expected to change over time. Long periods of sun exposure can naturally lead to color fading. Weather extremes, temperature fluctuations, and humidity highs/lows cause wood to expand and contract, possibly leading to warping and cracking. Knots and small surface cracks are naturally occurring and do not affect the strength of the product.
- **Keeping dry:** Prolonged moisture and high or low humidity can be harmful for wood. Cracking or splitting from extremes outside of the normal humidity range of 35-65% are not covered by our warranty. Preventing prolonged exposure to moisture is advisable.
- **Cleaning:** Frequent light cleaning is recommended. Dust regularly using a slightly damp soft cloth, and then wipe dry (following the direction of the wood grain). For more thorough cleaning, use a soft cloth and a gentle soap solution (dilute ¼ cup mild dishwashing liquid soap with 1 gallon of warm water). Rinse with water, and then immediately dry the surfaces using a soft cloth. Do not use bleach, acid, or other solvents on any metal parts or surfaces. Minor stains or scratches can be lightly buffed with No.0000 steel wool, followed by an application of good quality wood-care oil, wiping in the direction of the grain.
- **Annual sealing:** It is advisable to annually maintain the wooden parts with a sealant or outdoor wax/oil to protect and enhance the wood surfaces. Twice yearly, after cleaning, apply a good quality wood-care oil or water-based sealant to the surfaces. Recommended options are outdoor water-based sealant, linseed, teak, or tung oil. Refer to the manufacturer's specific instructions for application. It is best to try on a small section of wood, then if satisfied with the result, continue the application, taking care to avoid any metal surfaces.
- For further questions and concerns, please contact: [customer.care@sunjoygroup.com](mailto:customer.care@sunjoygroup.com)

# RECOMMANDATIONS POUR SOIN DU BOIS

Le bois exige un peu de soin et d'attention pendant sa vie pour assurer une belle finition durable. Le nettoyage et l'entretien convenables maintiendront la beauté de vos produits en bois plus longtemps. Veuillez suivre ces conseils pour préserver vos surfaces en bois.

- **Décoloration et érosion:** le bois est un produit naturel qui est prévu de changer avec le passage du temps. De longues périodes d'exposition au soleil peuvent naturellement conduire à la décoloration des couleurs. Les extrêmes météorologiques, les fluctuations de la température et les hauts / bas d'humidité provoquent l'expansion et la contraction du bois, ce qui peut entraîner à la déformation et aux fissures. Les noeuds et les petites fissures de surface sont naturelles et n'affectent pas la solidité du produit.
- **Garder au sec:** l'humidité prolongée et l'humidité élevée ou basse peuvent être défavorables pour le bois. La fissuration ou les fentes causées par les intempéries en dehors de la gamme d'humidité normale de 35 à 65% ne sont pas couvertes par notre garantie. Il est recommandé d'empêcher l'exposition prolongée à l'humidité.
- **Nettoyage:** un léger nettoyage fréquent est recommandé. Époussetez régulièrement avec un chiffon doux légèrement humide, et puis séchez (en suivant la direction du grain de bois). Pour un nettoyage plus profond, utilisez un chiffon doux et une solution de légère de savon à vaisselle (diluer ¼ tasse de savon lave-vaisselle doux dans 1 gallon d'eau tiède). Rincez avec de l'eau, puis séchez immédiatement les surfaces à l'aide d'un chiffon doux. N'utilisez pas de javelle, d'acide ou d'autres solvants sur aucune des pièces ou des surfaces métalliques. Les petites taches ou les rayures peuvent être légèrement polies avec de la paille de fer n ° 0000, suivie d'une application d'huile de soins pour bois de bonne qualité, étendue dans le sens du grain.
- **Enduit annuel:** Il est conseillé d'entretenir chaque année les pièces en bois avec un enduit scellant ou une cire ou huile extérieure pour protéger et améliorer les surfaces en bois. Deux fois par an, après le nettoyage, appliquez sur les surfaces une huile de soins de bois de bonne qualité ou un enduit scellant à base d'eau. Les options recommandées sont le scellant extérieur à base d'eau, les graines de lin, le teck ou l'huile d'abrasin. Consultez les instructions spécifiques du fabricant pour l'application. Il est préférable d'essayer une petite section de bois, et si vous êtes satisfait du résultat, continuez l'application, en prenant soin d'éviter les surfaces métalliques.
- For further questions and concerns, please contact: [customer.care@sunjoygroup.com](mailto:customer.care@sunjoygroup.com)

# WOOD CARE GUIDELINES

## Frequently Asked Questions

**Q1. What kind of wood is this made from?**

It is China-Fir (Cunninghamia/Cedar) wood.

**Q2. Is the wood waterproof?**

No, it is not waterproof, however it is water-resistant. It is able to resist the penetration of water to some degree but not entirely. Do not assemble the gazebo onto soil/sandy earth since water might puddle or pool around the gazebo posts, and stakes do not have enough anchorage in these types of soil.

**Q3. Before assembly, can I stain the wood parts with a different color stain?**

To change the color requires professional procedures, involving spraying equipment and waterbased stain only. This operation is not recommended.

**Q4. What should we apply to the wood to keep it looking good and maintained? Do I need to treat the wood to make it weather resistant?**

Yes, a cleaning and sealing regimen is advised. Please check our “ wood care guidelines” for details.

**Q5. Is there any way to seal the crack to prevent further damage? Does it affect the strength of the product?**

Knots and small checks (cracks) are naturally occurring and do not affect the strength of the product. It is advisable to annually maintain the wooden parts of the gazebo with a coat of water-base water repellent sealant or outdoor wax oil to protect & enhance the beauty of wood, if you are concerned that a part has experienced a severe weathering problem please contact our customer service department for further assistance.

**Q6. How do I remove mold from cedar wood?**

First thoroughly clean the wooden parts, following our “ wood care guidelines” cleaning regimen. Then clean with a chlorine-free “ oxygen” bleach cleaner, following the product’s instructions. Then clean with an oxalic acid wood/deck cleaner, following the product’s instructions. If necessary, re-stain the wood with water-based stain. Please maintain the wood parts regularly and keep them dry.

# RECOMMANDATIONS SUR LES SOINS DU BOIS

## Questions Fréquentes

**Q1. De quelle sorte de bois est-ce fait?**

C'est du Bois de Sapin Chinois (Cunninghamia/Cèdre).

**Q2. Le bois est-il imperméable?**

Non, il n'est pas imperméable, cependant il est résistant à l'eau. Il est apte à résister à la pénétration de l'eau à un certain degré, mais pas complètement. N'assemblez pas le gazébo sur un terrain de terre ou de sable car il peut se former des flaques d'eau ou l'eau peut s'accumuler autour des poteaux, et les piquets n'auront pas assez d'ancrage sur ces sortes de terrains.

**Q3. Avant d'installer, pouvons-nous teindre les pièces en bois d'un couleur de teinture différente?**

Pour changer la couleur, il faut des procédures professionnelles, impliquant uniquement des équipements de pulvérisation et des teintures à base d'eau. Cette opération n'est pas recommandée.

**Q4. Que devons-nous appliquer sur le bois pour garder sa bonne apparence et entretien ? Devons nous traiter le bois pour le rendre résistant aux intempéries?**

Oui, un régime de nettoyage et d'étanchéité est conseillé. Veuillez consulter nos «recommandations sur les soins du bois» pour plus de renseignements.

**Q5. Existe-t-il un moyen de sceller une fissure pour éviter plus de dommages? Est-ce que cela affecte la résistance du produit?**

Les noeuds et les petites marques (fissures) sont naturels et n'affectent pas la solidité du produit. Il est conseillé d'entretenir annuellement les parties en bois du gazébo avec une couche d'enduit à base d'eau ou de la cire extérieure pour protéger et améliorer la beauté du bois, si vous craignez qu'une pièce ait souffert un grave problème d'altération, veuillez contacter Notre service au client pour plus d'aide.

**Q6. Comment enlever la moisissure du bois de cèdre?**

Nettoyez d'abord les pièces en bois, en suivant notre régime de nettoyage dans les «recommandations de soins du bois». Ensuite, nettoyez avec un nettoyant une javelle sans chlore, ¼ oxygénée », en suivant les instructions du produit. Ensuite, nettoyez avec un nettoyant d'acide oxalique pour bois ou terrasse, en suivant les instructions du produit. Si nécessaire, refinissez le bois avec une teinture à base d'eau. Veuillez entretenir les pièces en bois régulièrement et les garder au sec.

## Maintenance

- Steel components for this gazebo are treated with rust inhibiting paint . However, due to the nature of steel, surface oxidation (rusting) will occur if these protective coatings are scratched. This is not a defect and thus not covered by the warranty.
- To minimize this condition, it is recommended to use care when assembling and handling the product to prevent scratching the paint. Should any scratching or damage occur, it is recommended to cover the scratch immediately with rust inhibiting resistant paint (not included).
- Surface rust can also be easily removed with a very light application of regular cooking oil or WD-40. If surface oxidation (rusting) occurs and if no measure is taken to prevent this, the oxidation may start dripping onto deck or patio and caused damaging stains, which may be difficult to remove. This can be prevented if the above-mentioned measures are taken to keep the product from oxidizing.
- An annual application of a water-based stain or sealant is recommended to reduce weathering and extend the life of your gazebo.
- Periodically check and ensure that all bolts are well-tighten during use.
- Inspect all wood parts regularly for damage or deterioration. Remove/sand splinters and replace any wood parts that are showing signs of structural damage. Note that knots, small cracks and weathering are natural in an outdoor wood product and do not negatively affect the structural integrity of the gazebo.
- Keep instruction manual for future reference.
- Keep the original packaging to store the gazebo.

## Limited Manufacturer's Warranty

Sunjoy Group warrants to the original purchaser that this item is free from defects in workmanship and materials for a period of 1 year from the date of purchase, provided the item was factory-sealed at the time of purchase and is maintained with care and used only for personal, residential purposes. Should any manufacturing defect arise within this warranty period, Sunjoy Group will replace (at our option) any defective merchandise or parts upon proof of purchase; however, transportation and delivery costs, as well as payments to a third party for assembly or disassembly of the item, remain the responsibility of the purchaser. A purchaser of an "open box," previously-returned, or "clearance" item, as well as original purchasers outside of the warranty period, may obtain replacement parts from Sunjoy Group for products in current production, at nominal cost.

## Exclusions

Items used for commercial, contract, or other non-residential purposes, or items damaged due to acts of nature, vandalism, misuse, or improper assembly are not covered. Corrosion or rusting of hardware is not covered.

Proof of purchase (dated register receipt) is required for warranty claims. Warranty is to the original purchaser and is non-transferable. Any replacement of warranted items will be in the original style and color, or a similar style and color if the original is unavailable or has been discontinued. As some states do not allow exclusions or limitations on an implied warranty, the above exclusions and limitations may not apply. This warranty gives you specific rights, and you may also have other rights, which vary from state to state.

## Care and Maintenance

- Les composants en acier de ce belvédère sont traités avec une peinture antirouille. Toutefois, en raison de la nature de l'acier, une oxydation de la surface (rouille) se produira si ces revêtements protecteurs sont égratignés. La garantie ne couvre pas ce phénomène puisqu'il ne s'agit pas d'un défaut.
- Afin de minimiser cette situation, nous recommandons d'être prudent lors de l'assemblage et de la manipulation du produit afin d'éviter d'égratigner la peinture. En cas d'égratignure ou de dommage, nous recommandons d'effectuer immédiatement une retouche avec une peinture antirouille.
- La rouille de surface peut facilement être retirée à l'aide d'une petite quantité d'huile de cuisson ordinaire ou de WD-40. Si une oxydation (rouille) de la surface se produit et qu'aucune mesure n'est prise pour corriger la situation, la rouille pourrait couler sur la terrasse et causer des taches dommageables qui peuvent être difficiles à enlever. Cela peut être évité si les mesures mentionnées ci-dessus sont prises pour empêcher l'oxydation du produit.
- Une application annuelle d'une teinture ou d'un scellant à base d'eau est recommandée pour résister aux intempéries et prolonger la durée de vie de la tonnelle.
- Vérifiez périodiquement pour vous assurer que tous les écrous sont bien serrés pendant l'utilisation.
- Inspectez régulièrement toutes les pièces en bois pour détecter tout dommage ou détérioration. Enlevez/ poncez les éclats et remplacez toutes les pièces en bois qui montrent des signes de dommages structuraux. Notez que les noeuds, toutes les fissures et les intempéries sont naturels dans un produit en bois extérieur et n'affectent pas négativement l'intégrité structurelle de la tonnelle.
- Conservez le manuel d'instructions pour référence future.
- Conservez l'emballage d'origine pour ranger la tonnelle.

## Garantie limitée du fabricant

Sunjoy Group garantit à l'acheteur initial que ce produit ne présentera aucun défaut de fabrication et de matériaux pendant une période de un an à compter de la date de l'achat si le produit a été acheté dans son emballage scellé à l'usine, et s'il a été entretenu correctement et utilisé à des fins personnelles et résidentielles seulement. Si le produit présente un défaut de fabrication pendant cette période de garantie, Sunjoy Group remplacera (à sa discrétion) toute marchandise ou pièce défectueuse sur présentation d'une preuve d'achat. Toutefois, les frais de transport et de manutention, ainsi que les paiements versés à un tiers pour l'assemblage ou le démontage du produit, demeurent la responsabilité de l'acheteur. Les acheteurs de produits avec « boîte ouverte », précédemment retournés ou « en liquidation », ainsi que les acheteurs initiaux de produits dont la période de garantie est terminée, peuvent obtenir des pièces de rechange auprès de Sunjoy Group pour des produits actuellement en production, à peu de frais.

## Exclusions:

les articles utilisés à des fins commerciales, locatives ou non résidentielles et les articles endommagés par des phénomènes naturels, des actes de vandalisme, un usage inapproprié ou un assemblage inadéquat ne sont pas couverts. La corrosion et la rouille de la quincaillerie ne sont pas couvertes. Une preuve d'achat (une copie de votre reçu daté) doit être présentée avec toute réclamation au titre de la garantie. La garantie n'est accordée qu'à l'acheteur initial et est non transférable. Si l'article original n'est plus offert, il sera remplacé par un article d'une couleur et d'un style similaires. Certains États ou certaines provinces ne permettent pas l'exclusion ou la limitation d'une garantie implicite, de sorte que les limitations et exclusions mentionnées ci-dessus peuvent ne pas s'appliquer à vous. Cette garantie vous confère des droits précis. Il est possible que vous disposiez également d'autres droits, qui varient d'un État ou d'une province à l'autre.