

Instruction Manual

Wireless NVR Set



Foreword	1
1.Product function overview	2
1.1 Product Brief	2
1.2 Product parameters	2
2. Instructions	4
2.1 Front panel description	4
2.2 Rear Panel Interface Description	4
2.3 Mouse Operation Instructions	5
2.4 Input method description	5
2.5 Interface description	6
2.5.1 Interface Element Description	6
2.5.2 Description of Common Buttons	6
2.6 Menu Description	6
3. Installation and connection	8
3.1 Installation Precautions	8
3.2 Preparation before installation	8
3.3 Camera is placed in a preset position	9
4. System Function Introduction	9
4.1 Switch machine	9
4.1.1 Boot	9
4.1.2 log in	10
4.1.3 restore default	11
4.1.4 logout	12
4.1.5 reboot	12
4.1.6 shut down	12
4.2 boot wizard	12
4.3 IPC pairing	15
4.3.1 IPC pairing status	15
4.3.2 Wireless working status	15
4.3.3 Cascading information	16
4.3.4 IPC pairing	16
4.3.5 Device removal	16
4.4 IPC settings	17
4.4.1 Image settings	17
4.4.2 Preview settings	18
4.4.3. Encoding settings	18
4.4.4 Advanced settings	19
4.4.5 Camera upgrade	20
4.5 System settings	20
4.5.1. General settings	21
4.5.2. Preview settings	21
4.5.3. Video plan	22

4.5.4. Video backup	23
4.5.5. Network settings	23
4.5.6. Storage management	25
Note: Please turn off the device before installing or replacing the hard disk.	25
4.5.7. User Management	25
4.5.8. Alarm function	26
4.5.8. Exception handling	28
4.5.9. Restore default	29
4.5.10. System upgrade	30
4.6 Video playback	30
4.7 PTZ control (reserved function)	32
Special Note: At present, this function is only reserved for NVR. The camera does not support the PTZ control function at the moment. Cameras that support PTZ control will be launched later.	32
4.8 system message	32
4.9 Shut down the system	34
4.10 Four screen switching	34
5 Mobile P2P access	35
Single-screen and multi-screen preview interface	37
6. Appendix	38
6.1 Hard disk capacity unit conversion	38
6.2 Calculation of required capacity for recording	38

Foreword

Thank you very much for purchasing our company's products. If you have any questions or needs, please feel free to contact us.

Statement

We have tried our best to ensure the completeness and accuracy of the content of the manual, but it is inevitable that there will be technical inaccuracies, inconsistencies with product functions and operations, or typographical errors. If there are any questions or disputes, please refer to the final interpretation of our company.

Products and manuals will be updated in real time without notice.

The content in this manual is only for users to provide reference guidance, and it is not guaranteed to be completely consistent with the actual product, please refer to the actual product.

The parts, components, and accessories mentioned in this manual are for illustrative purposes only, and do not represent the configuration of the purchased model. For detailed configurations, please refer to the packing list.

Special statement

When using video surveillance equipment, for the use and maintenance of the monitoring interface, please strictly abide by applicable laws and regulations. The use of video surveillance equipment for illegal purposes and listening to the privacy of others are all illegal interceptions.

About default

- Factory default super administrator account: admin
- The factory default password of admin is admin.
- The factory default automatically overwrites the previous recording data when the hard disk recording is full.
- The device starts the boot wizard by default.

1.Product function overview

1.1 Product Brief

JD4NK1038-2MPW/JD4NK103T8-2MPW Wireless network hard disk recorder. It is a new-generation NVR (Net Video Recorder) product independently developed. It supports wireless WIFI network video access, supports up to 1080P wireless real-time video preview, video encoding and playback operations.

1.2 Product parameters

WiFi Camera Parameters

Model	1080P wireless HD network camera
Image Sensor	1/2.9" 2M Pixel CMOS
illumination	0.1 Lux@F1.2(Color mode), 0.05 Lux@F1.2 (Black&white mode); 0Lux (Infrared light)
Signal to Noise Ratio	≥39dB
Shutter	1/5 - 1/20,000s, support slow shutter
Day&Night Mode	Automatic ICR filter color to black, fixed black and white, fixed color, external control
Gain Control	Automatic / Manual
White Balance	Automatic, indoor, outdoor, sodium lamp mode, manual
Wide Dynamic	Support digital wide dynamic
Digital Noise reduction	Support DNR,3DNR
Video Compression	H.265 Main profile/H.264 Main profile/M-JPEG
Audio	Audio compression: G711, PCM 1 input: linear, impedance 1KΩ, 1 output, linear, impedance 600
Resolution	1920x1080@20fps
Video Resolution	Main Stream: 1920x1080、1280×720、720×576、640×480
	Secondary Stream: 640×480、480×360、352x288、176x144
Output Code Rate	Fixed bit stream (CBR) or variable bit rate (VBR), bit stream can be set range: 32K ~ 10M
Motion Detection	Support, 4 motion detection areas
Privacy Zone	Support, 4 privacy areas
Network Protocol	TCP/IP, HTTP, NTP, IGMP, DHCP, UDP, SMTP, RTP, RTSP, ARP, DNS
Wireless Band	2.4G
Wireless Distance	The barrier-free transmission distance is more than 200 meters, and the wall is more than 50 meters. The actual transmission distance depends on the environment
Power Supply	12V DC@0.12A
Temperature	-30°C ~50°C
Humidity	0%-90% RH (No condensation)

Wireless NVR parameters

Model		8-channel WIFI 1080P HD NVR
System	Main Processor	Industrial grade embedded microcontroller
	Operating System	Embedded linux operating system
Video Parameters	Image Decoding	H.265 main profile lever 4.2
	Video Output	1080P@60fps
	Video Access	4*1080P/4*960P/4*960P
Audio Parameters	Decoding Standard	G.711
	Voice Intercom	No
Recording&Playback	Recording Method	Manual recording, motion detection recording, timing recording,
	Video Playback	8-CH 960P or 8-CH 1080P synchronous playback, playback speed
Storage and Backup	Space	Video: 1080P 20G / day;
	Backup Method	Support hard disk storage and U disk backup
Internet	Network Protocol	TCP/IP,HTTP,DHCP,UDP,RTP,RTSP,FTP,NTP,P2P
	Phone	Support iPhone, android mobile phone monitoring
	Browser	Support browser IE
Wireless	Wireless Module	Built-in professional management and control wireless receiving
	Antenna	Two 5dB antennas
	Distance	Unobstructed acceptance distance of 300 meters
Interface	Video Input	4 channel 1080P network input
	Video Output	1 VGA output, 1 HDMI output
	Audio Input	No
	Audio Output	1 way
	Alarm Input	No
	Alarm Output	No
	Network Interface	RJ45 10M / 100Mbps adaptive Ethernet interface
	USB	2 USB 2.0 ports
	Hard Disk	Internally support 1 SATA hard disk (maximum support 6T)
other	Power Supply	DC +12V /3A
	Power	3W(Without hard drive)
	Temperature	-10℃ — +55℃
	Humidity	10% — 90%

2. Instructions

2.1 Front panel description



1. POW: Power indicator 2. Net: Network indicator 3. HDD: Hard disk indicator

2.2 Rear Panel Interface Description

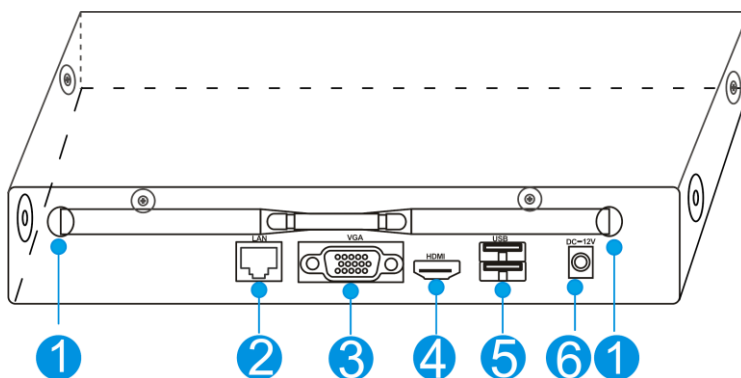

S/N	name	Description
1	Antenna	Install antenna
2	LAN	Connect to LAN or external network
3	VGA	Connect a VGA monitor
4	HDMI	Connect an HDMI display
5	USB	Connect to operate mouse or U disk
6	Power	Connect 12V2A power adapter

Mouse Button	Action	Effect	for Example
Left Button	Click	Selected	1、 Check button, drop-down box, list box, check box, radio box
	Double click	Window Zoom	1、 Switch between single interface and multiple interfaces during preview 2. Add device
	Drag	Setting Area	1、 Set the motion detection area 2. Select the electronic zoom area
Scroll Wheel	Scroll	Change Content	1. Change the content of the drop-down box 2. When zooming in the preview, sequentially switch the channel interface
Right Button	Click	Drop Out	1. Close the interface 2. Display the shortcut menu on the main interface

2.3 Mouse Operation Instructions

2.4 Input method description

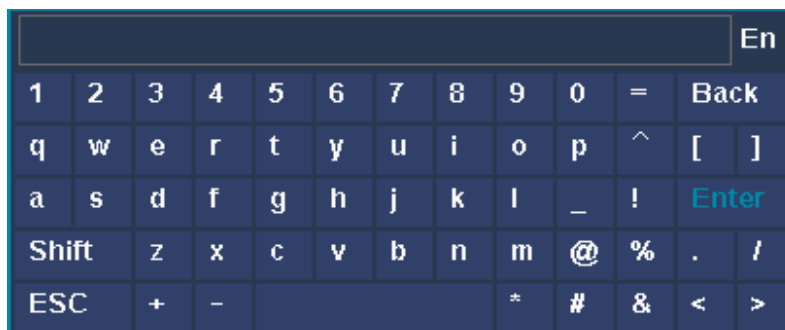





Name	Key Description	Function Description
Digital	0~9	Enter the number 0 ~ 9
Character	- ^ _ ! @ % / . + - * # & < >	Input symbol
Upper / lower case	Shift	Switch between uppercase and lowercase letters
Backspace	Back	Delete the character before the cursor
Confirm	Enter	Enter confirmation

2.5 Interface description

2.5.1 Interface Element Description

Name	operating	Operation function	Examples
Button	Left click	Save or cancel	Apply, confirm, cancel
		Open sub-interface	Edit, set
Edit box	Left click	modify	change Password
Drop-down box	Left click	select	Choose a language
List box	Left click	View	Channel information
Checkbox	Left click	Select or cancel	Boot wizard display
Text	Left click	Instructions	Title, name

2.5.2 Description of Common Buttons

Name	icon	Explanation
Refresh		Refresh the interface setting status
Determine		Save the operation and take effect, close the operation interface.
Cancel		Cancel the operation just now.
Application		Save the operation and take effect, without closing the operation interface.
Copy		Copy the settings of this channel to other or all channels.

2.6 Menu Description

Right-click menu: IPC pairing, system settings, video playback, video plan, video backup, PTZ control, IPC settings, system information, system shutdown, multi-screen switching

System settings: general settings, preview settings, video plan, video backup, network settings, storage management, user management, alarm function, exception handling, restore default, upgrade system.

As shown below:

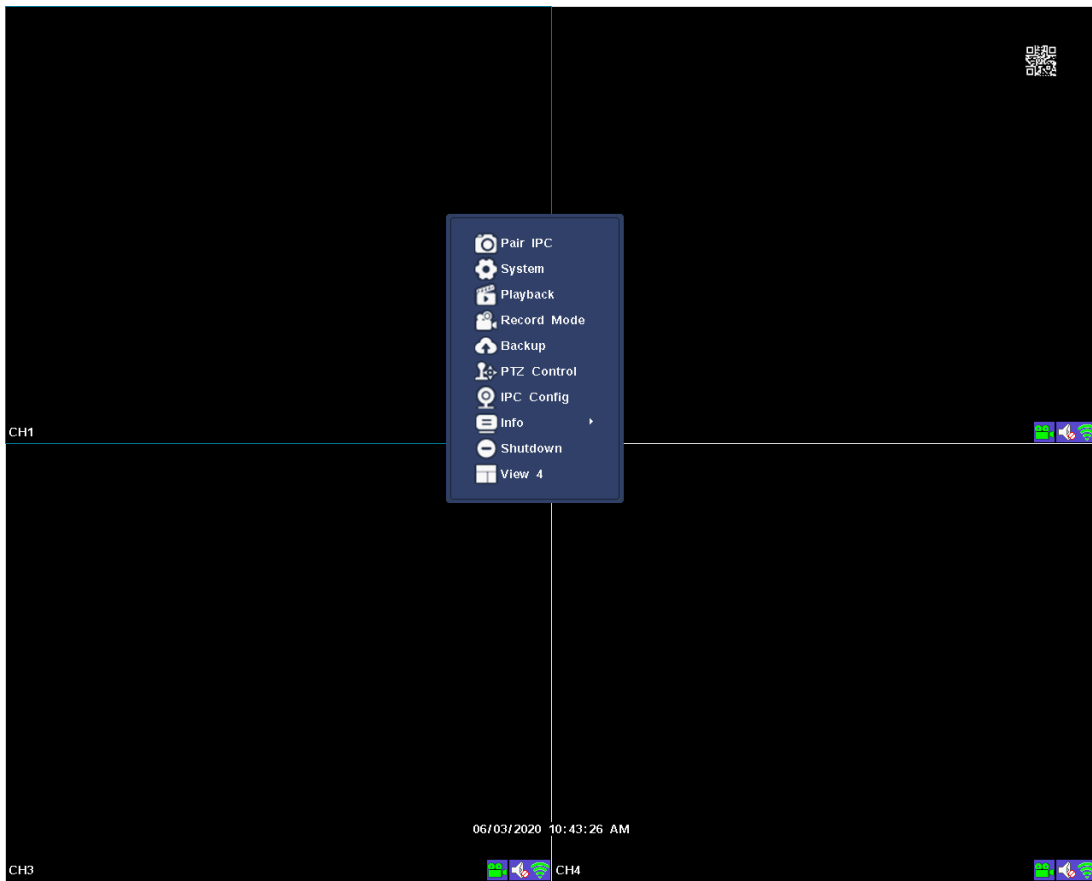

Right-click menu interface



System Settings Main Menu

3. Installation and connection

3.1 Installation Precautions

Note the following when installing and using:

- 1、 In order to extend the life of the machine, the machine should be kept away from water, high temperature and dusty environment, and placed in a well-ventilated place.
- 2、 Please use SATA hard drives, USB devices, and mouse devices purchased through regular channels.
- 3、 Before use, please make sure that the network HD recorder is properly grounded and the power supply cannot exceed the normal operating voltage range of the power supply.

3.2 Preparation before installation

1、 Determine where to place the NVR

It is recommended to put the NVR in the center of the surveillance area, and avoid obstacles between the IPC (wireless camera) installation location and the NVR. When 4 channels of video are connected at the same time, when there is no obstacle between NVR and IPC, IPC is placed in the spherical coverage area with NVR as the center of the sphere and a radius of 60 meters. 30 meters, two walls reduce the radius to 15 meters

2、 Connection steps

Install the hard disk to the NVR, as shown in the figure, after the installation is complete, first connect the NVR to the mouse and the display, turn on the power, and connect the power to the IPC.

- (1) Using a screwdriver, remove the top cover;

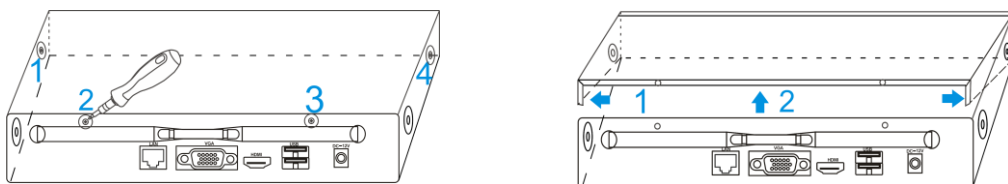

- (2) Install the hard disk data cable and power cable, and tighten the screws;

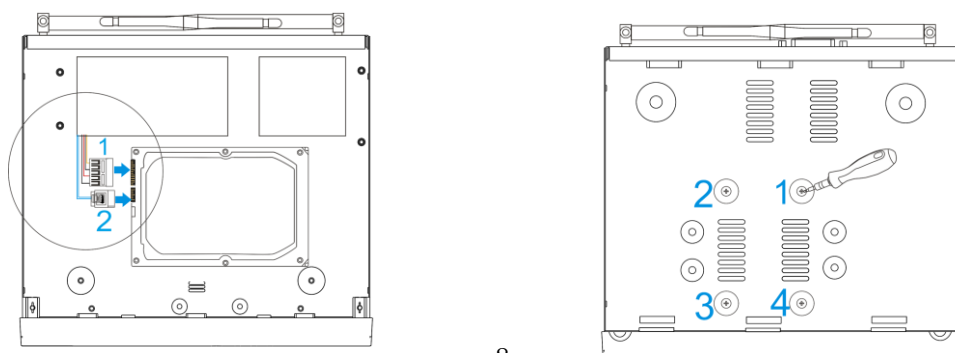

(3) Confirm that the wireless NVR package is working properly

The NVR is connected to the monitor, and all supporting IPCs are placed around the NVR. Can be installed to a predetermined location.

3.3 Camera is placed in a preset position

- 1、 Install the wireless camera to the preset position within the effective coverage of the wireless signal and provide 12V power supply;
- 2、 When the wireless camera is powered on for about 1 minute, you can see the video on the NVR monitor;
- 3、 If there is no image, it indicates that the distance is too far, the distance needs to be shortened.

NVR antenna transmits signals to the surroundings. The NVR and IPC antennas are at the same height and parallel to each other. The best effect is if the antennas are not at the same height. The IPC antenna should be tangent to the spherical surface with the NVR as the center (Figure 6) Point directly to the NVR (Figure 7)

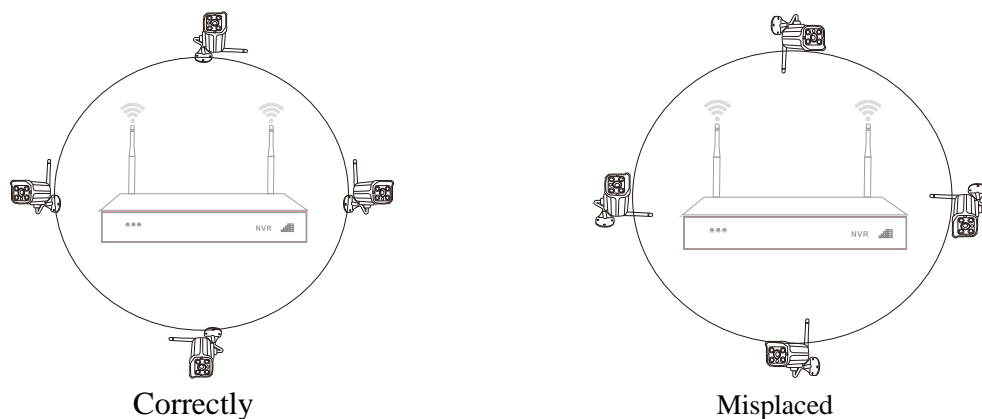

4. System Function Introduction

4.1 Switch machine

4.1.1 Boot

Note:

Please confirm that the connected voltage matches the requirements of the hard disk recorder, and ensure that the ground terminal of the hard disk recorder is well grounded.

When the power supply is abnormal, it will cause the hard disk recorder to not work normally, or even damage the hard

disk recorder. It is recommended to use a regulated power supply.

Explanation: Before turning on, please make sure that a monitor or monitor is connected to the video output port of the device.

Specific boot steps are as follows:

- 1、 Plug in the power supply, the power indicator on the front panel is red.
- 2、 Device starts to boot, the boot screen is as shown below:



4.1.2 log in

After the system is turned on and started, after the system is initialized, the system automatically displays the image preview interface. The login interface pops up automatically after the user's operating system. As shown below. The user needs to complete the login before proceeding.

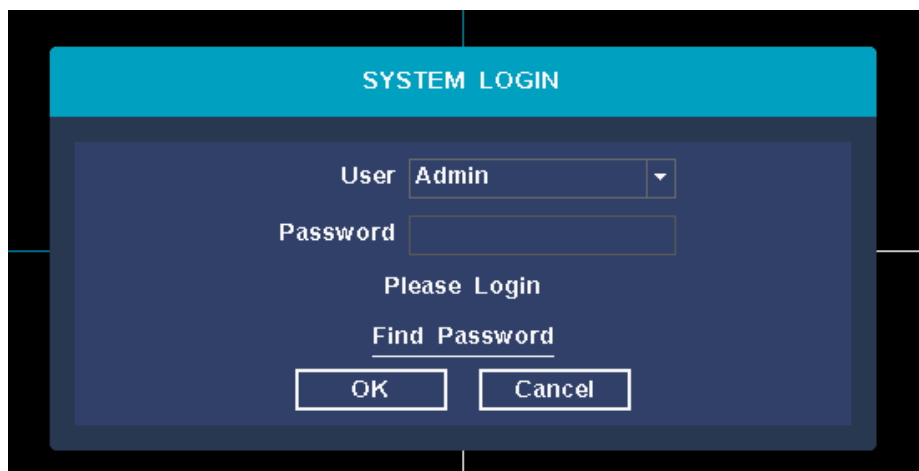



Steps:

- 1、 Click the user name edit box with the left mouse button, and enter the user name of the local login, default factory set user name is admin.
- 2、 Click the password edit box with the left mouse button, and enter the password for local machine login, the default factory-set password is admin.
- 3、 Click "OK" with the left mouse button to complete the login.

Explanation:

Password can be composed of numbers, characters, operators and dots, *, #, and the length cannot exceed 12 characters.

pls attention: If you forget your password. You can click to retrieve the password, the system will automatically generate a random number, send the random code to the customer service of the supplier, and request a new login password, as shown in the following figure:

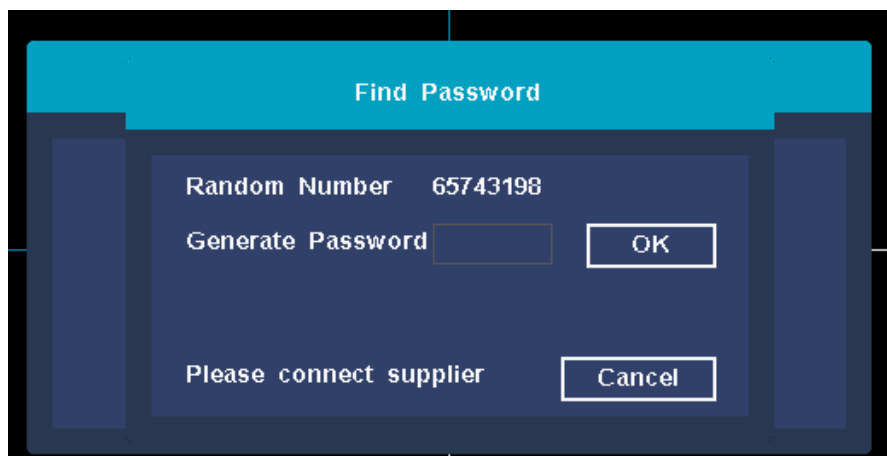

4.1.3 restore default

If you need to restore the default during use, you can right-click the shortcut menu, choose to shut down the system, and click Restore Default to restore the default settings. As shown below:

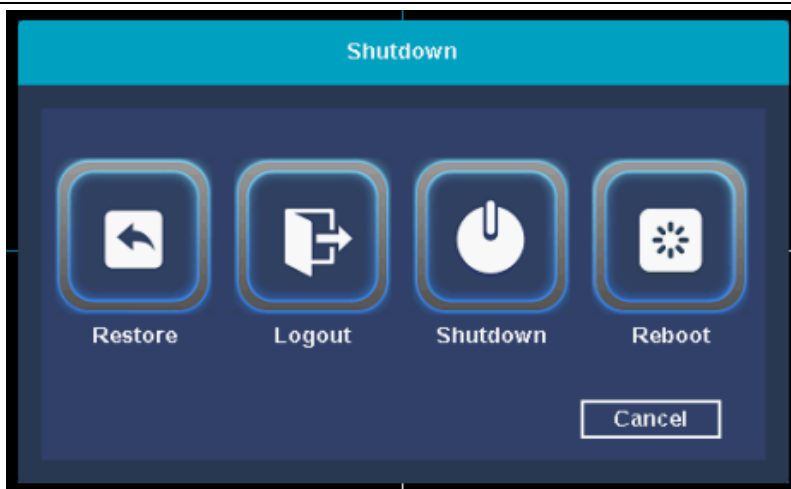

4.1.4 logout

If you need to log out the user during use, you can right-click the shortcut menu, choose to shut down the system, and click logout to complete.

The user needs to re-enter the user name and password when logging out of the system and operating again.

4.1.5 reboot

If users need to restart the machine during use, they can right-click the shortcut menu, choose to shut down the system and click restart to complete.

4.1.6 shut down

If users need to shut down the system during use, they can right-click the shortcut menu, choose to shut down the system, click to shut down the system to complete.

4.2 boot wizard

After successful login, the system will automatically open the "Setup Wizard" interface to guide the user to make basic settings, so that the machine can work normally.

operating step:

1、 **Setting 1:** setting wizard. Can set whether to open the boot wizard. The setting interface is as shown in the figure below, after the operation is completed, left click the next button.



2、 **Setting 2:** wireless channel. Set the WiFi channel of the device to ensure compliance with local laws and regulations.

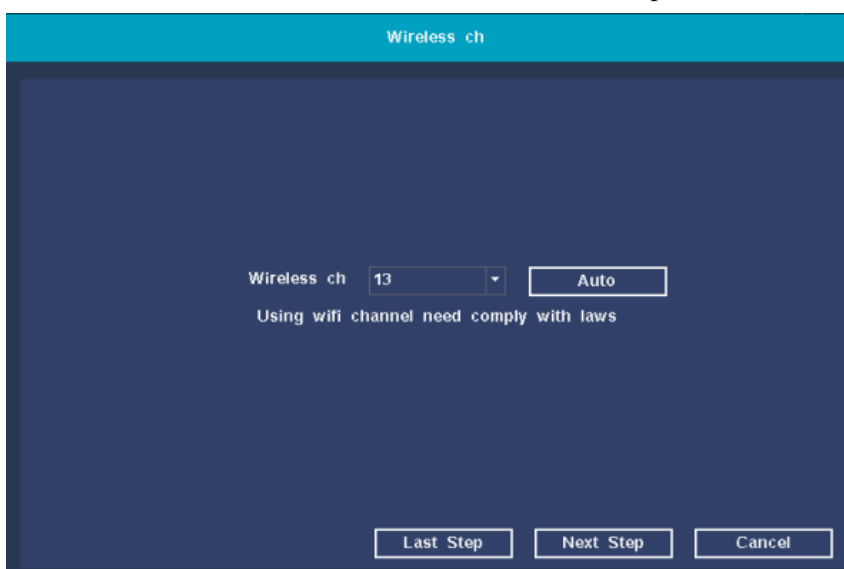

3、 **Setting 3:** General setting. You can set the system time, date format, time zone, language selection, resolution, auto logout time, daylight saving time, IPC time synchronization, and start wizard. The interface is as shown in the figure below, after the operation is completed, left click the next button.

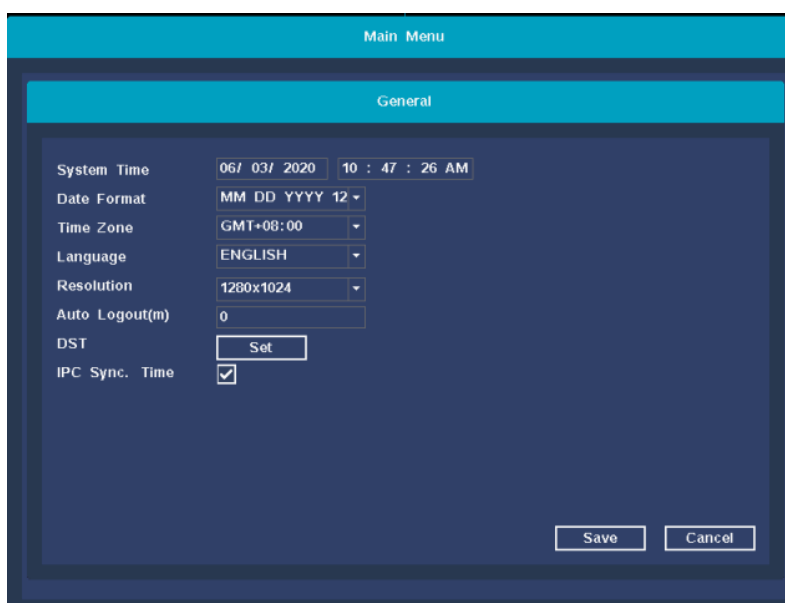

Operation Manual of Wireless NVR Kit

4、 **Setting 4:** network settings. You can choose to automatically obtain an IP address, manually set the IP address, and network diagnostic operations. The operation interface is as shown in the figure below. After the operation is completed, click Next to continue the wizard setup. If you need to return to Setup 3, select the previous step.

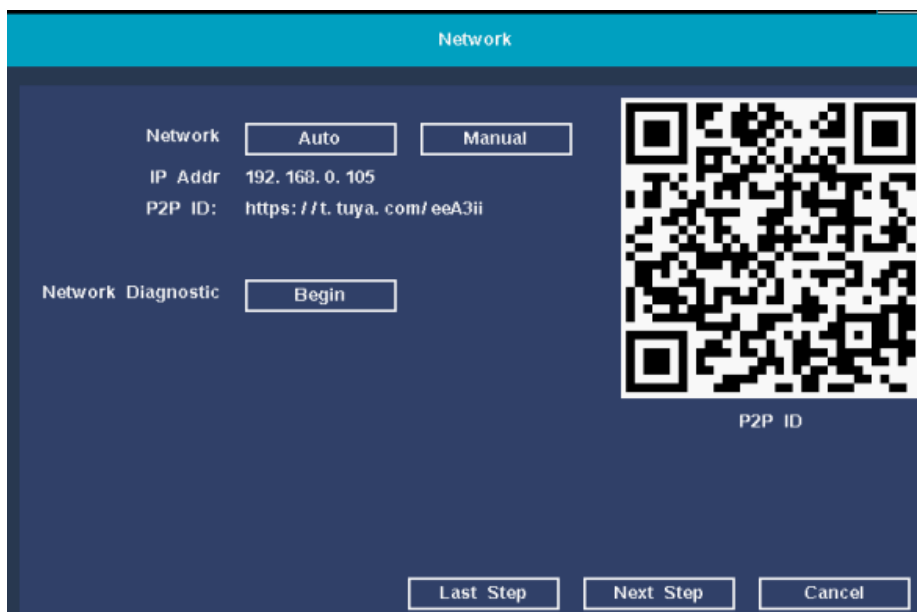

5、 **Setting 5:** Hard disk settings. It can display the list of currently existing hard disks, including model, capacity, usage, status, and format status. If users need to format the hard disk, they can first select the corresponding hard disk, and then click the format button. After a while, the selected hard disk can be formatted, and the format status of the hard disk will also be displayed as "formatted". The operation interface is as shown in the figure below. After the operation is completed, click Finish after the settings are completed to complete all the above settings. If you need to return to Settings 5, select the previous step. If you click Cancel, the above settings will not take effect.

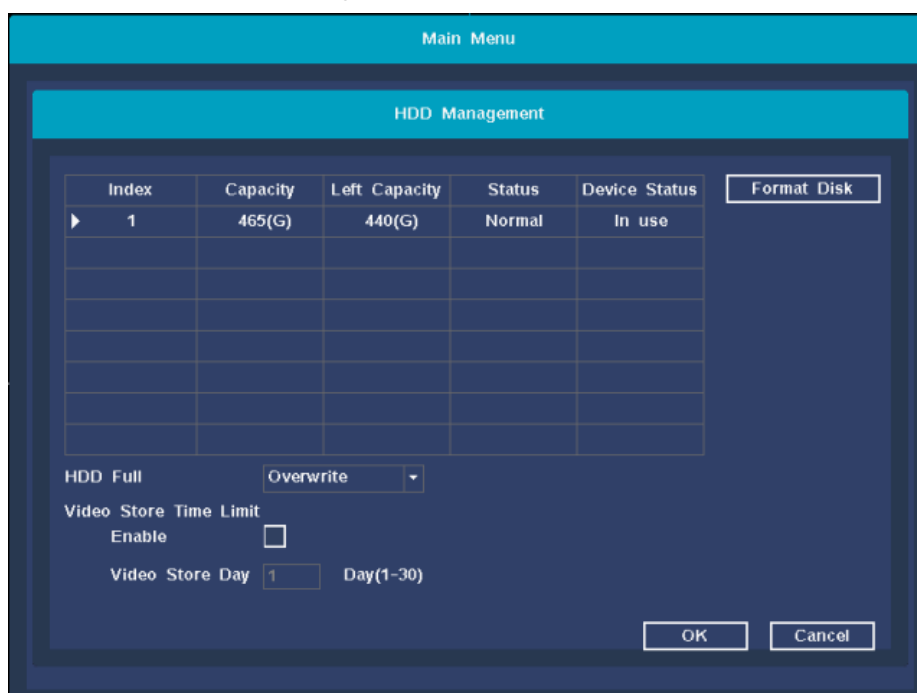

4.3 IPC pairing

4.3.1 IPC pairing status

Function Description: Used to check the status of the IPC channel and whether it is connected.

Steps: Right-click the main interface of the system, click the **【Pair IPC】** submenu in the pop-up right-click menu, enter the IPC pairing interface, and view the status of the IPC channel. You can view the channel connection and channel status. As shown below:

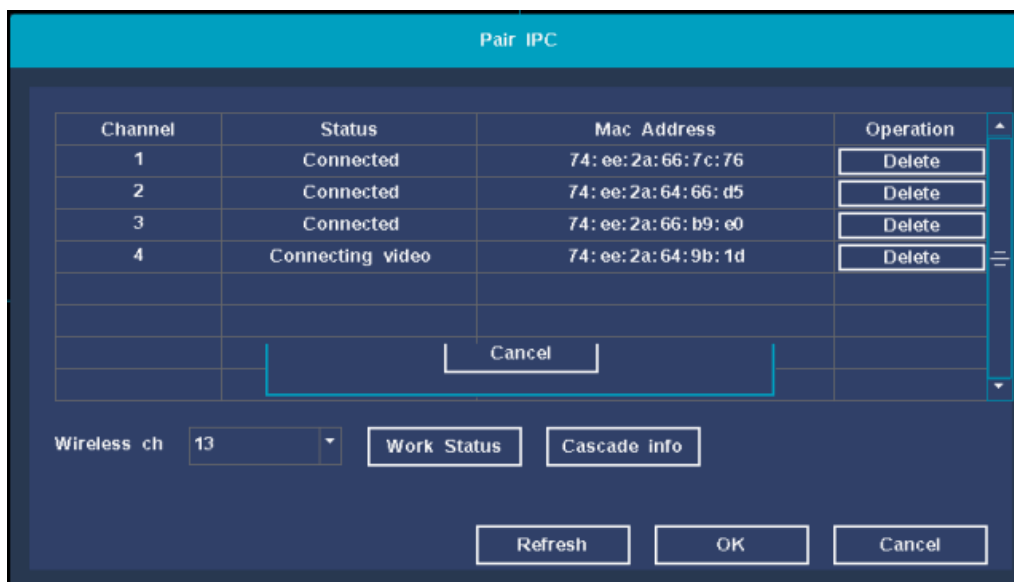

4.3.2 Wireless working status

Function Description: Used to view the network status of all IPCs and NVRs in the IPC channel.

Steps: In the IPC pairing interface, click the **【Work Status】** button to complete the wireless status query. It can display WiFi version information, WiFi interference situation, WiFi signal strength of each IPC channel. As shown below:

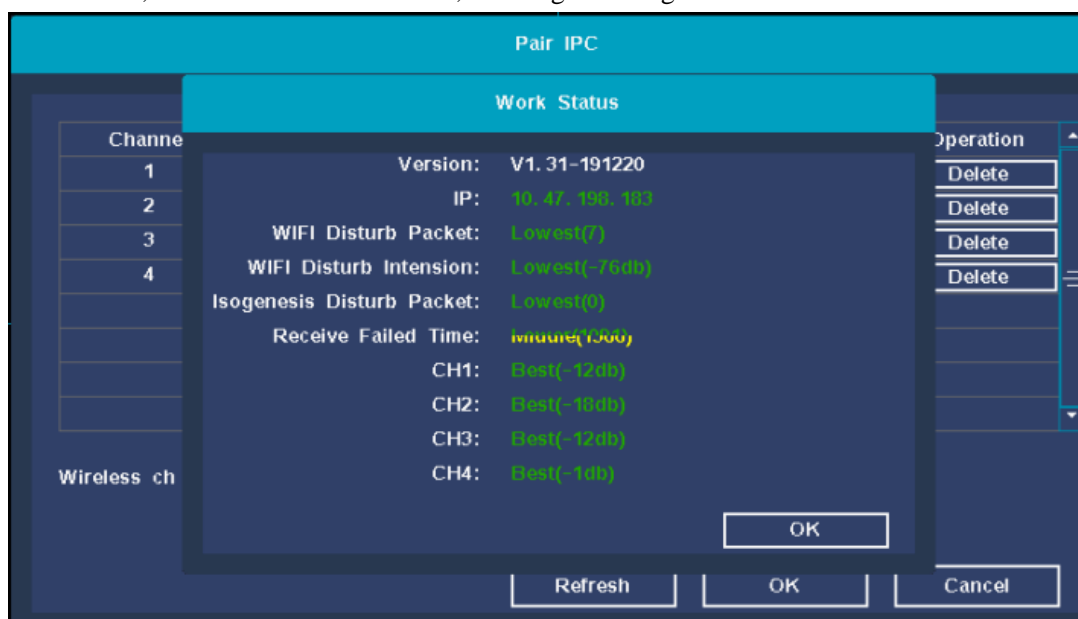

4.3.3 Cascading information

Function Description: Used for relay cascading information of added IPC devices.

Steps: On the IPC pairing interface, click the **【Cascade info】** button to view the cascade information.

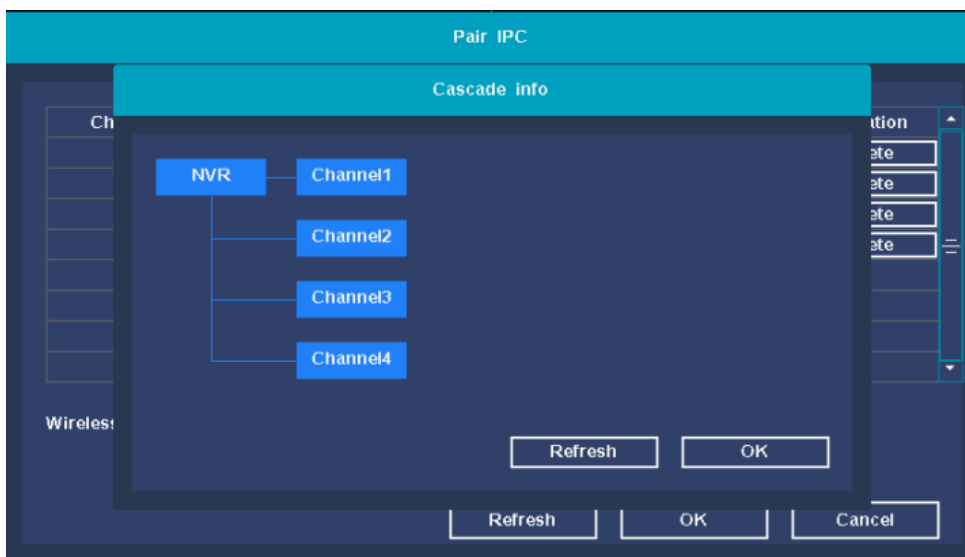

4.3.4 IPC pairing

Function Description: Used to pair IPC devices and add cameras.

Steps: In the IPC pairing interface, find the unpaired channel, click the **【Pair IPC】** button, the interface displays a prompt box, pairing, long press 5s to add the paired IPC pairing button, the system prompts that the pairing is successful, is obtaining IPC information, click **【OK】** Button to complete the pairing and adding operation.

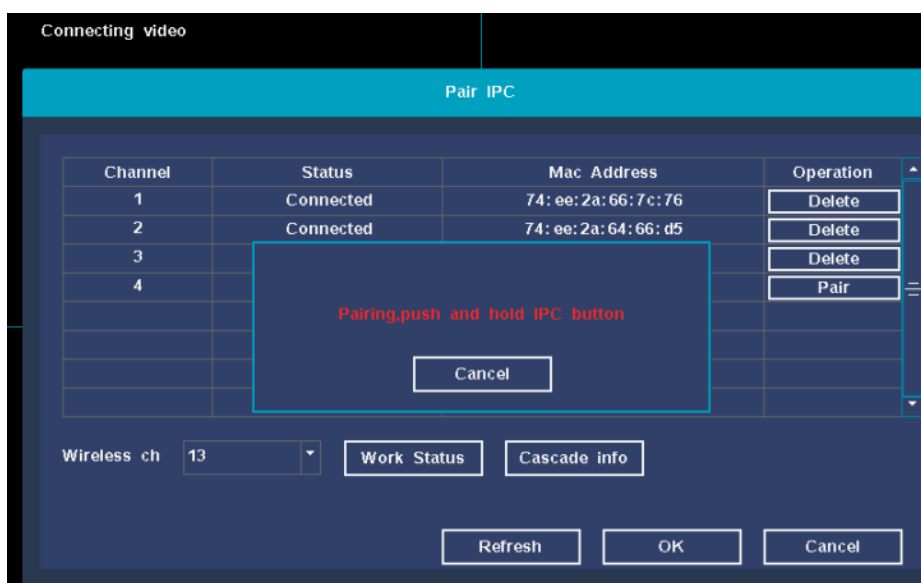

4.3.5 Device removal

Function Description: Used to delete channel devices.

Steps: On the IPC pairing interface, select the camera to be deleted and click the **【Delete】** button, a prompt box will pop up: Are you sure you want to delete? After deletion, you need to re-pair, click the **【OK】** button to complete the device deletion operation. As shown below:

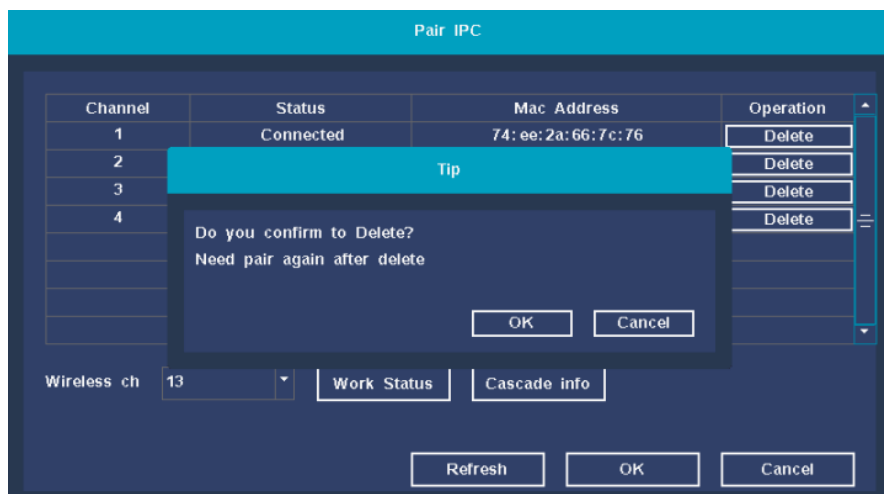

4.4 IPC settings

IPC setting function: image setting, preview setting, encoding setting, advanced setting, camera upgrade.

4.4.1 Image settings

Function description: Set the image parameters of IPC device channels: brightness, contrast, hue, saturation, sharpness, image quality, video format, horizontal and vertical flip, backlight compensation, defogging, digital wide dynamic, wide dynamic intensity.

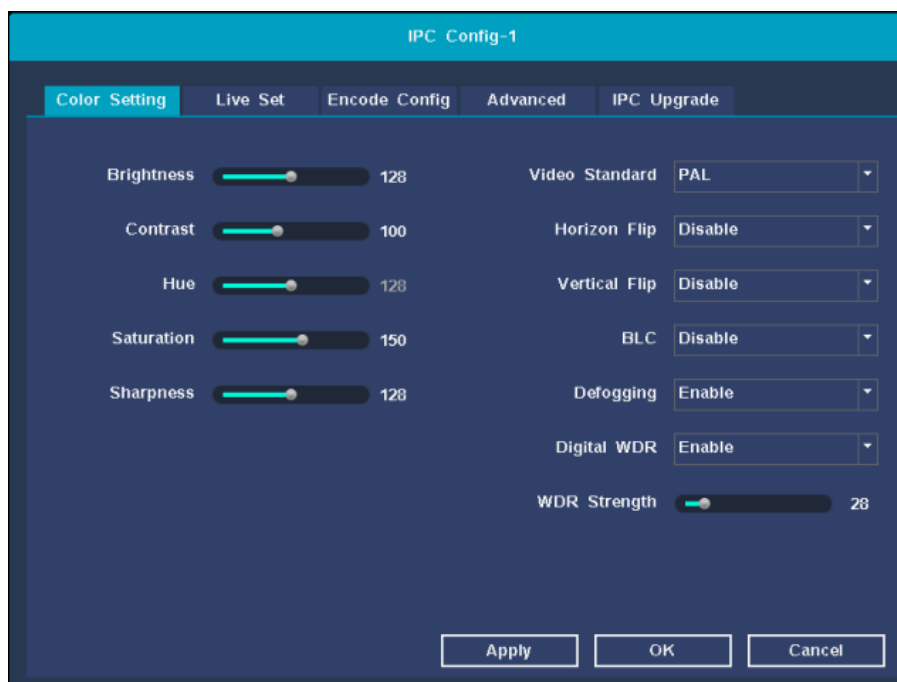

Steps:

- 1、Right-click the main interface of the system, select **【IPC Config】** in the pop-up right-click menu, and the image setting interface opens by default;
- 2、The user adjusts the camera image parameters according to his needs, click **【Apply】**, and then click the **【OK】** button to save the user modified parameters. As shown below:

4.4.2 Preview settings

Function description: IPC equipment channel title switch, channel position, channel name, font size, time title switch, time position, time automatic size setting.

Operation steps: On the IPC configuration interface. Click the **【Live Set】** title, click to enable or disable the channel title, and the time title is displayed. Set the title position and font size. Click **【Apply】** and then click **【OK】** to save the setting parameters. As shown below :

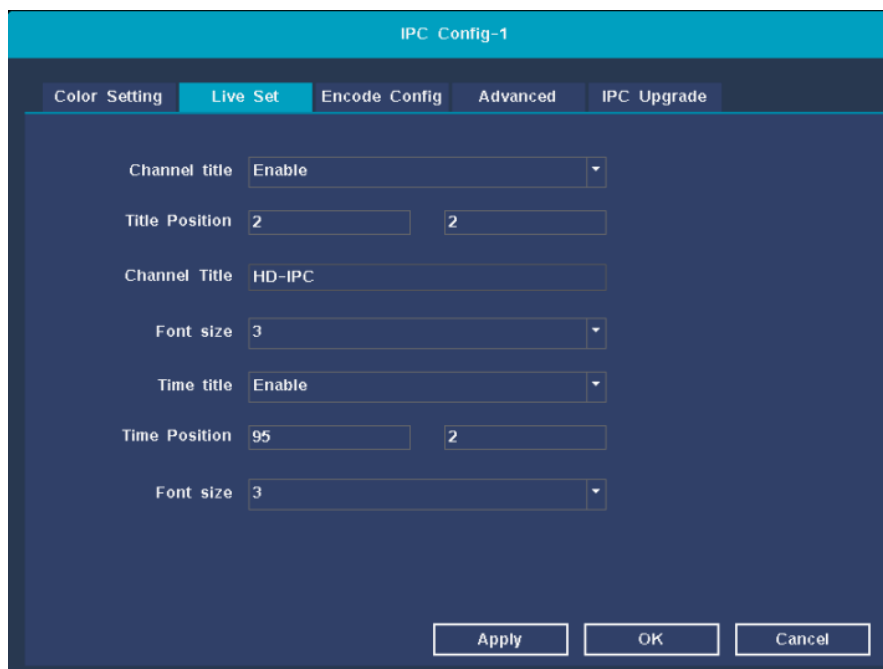

4.4.3. Encoding settings

Function description: View the IPC device's primary and secondary stream coding, resolution, bit rate control mode, I frame interval, stream value, frame rate and other information.

Operation steps: On the IPC configuration interface. Click the **【Encode Config】** heading to enter the encoding setting interface. Currently, it only supports viewing encoding information and does not support customer-defined modification functions. As shown below:

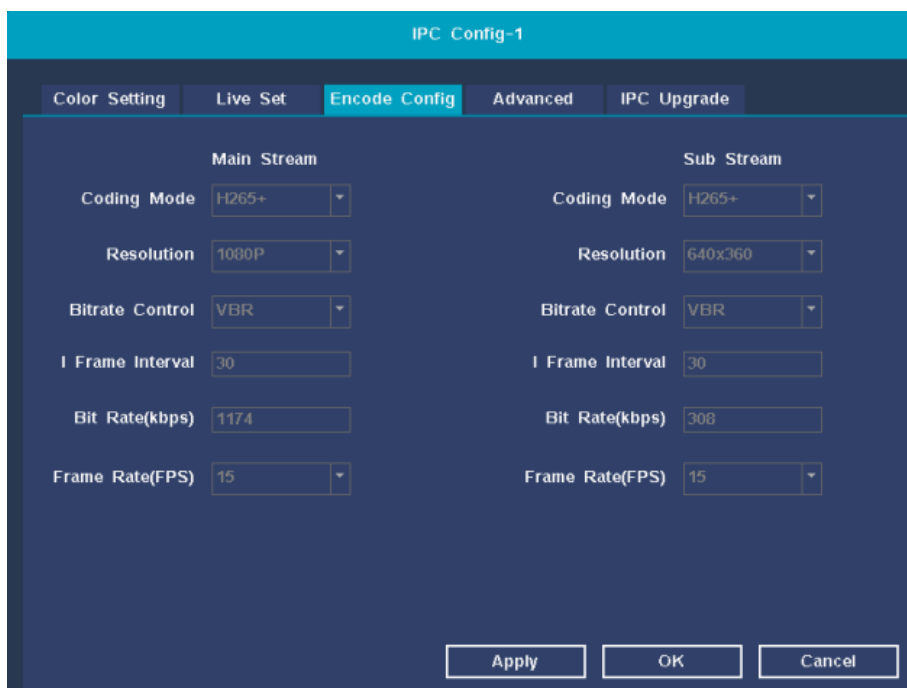

4.4.4 Advanced settings

Function description: IPC equipment motion detection and humanoid recognition switch, sensitivity adjustment and area setting.

Operation steps: On the IPC configuration interface. Click the **【Advanced】** heading to enter the advanced settings interface. You can manually turn on or off the motion detection and humanoid recognition functions, adjust the sensitivity level, and set the motion detection and humanoid recognition areas. As shown below:

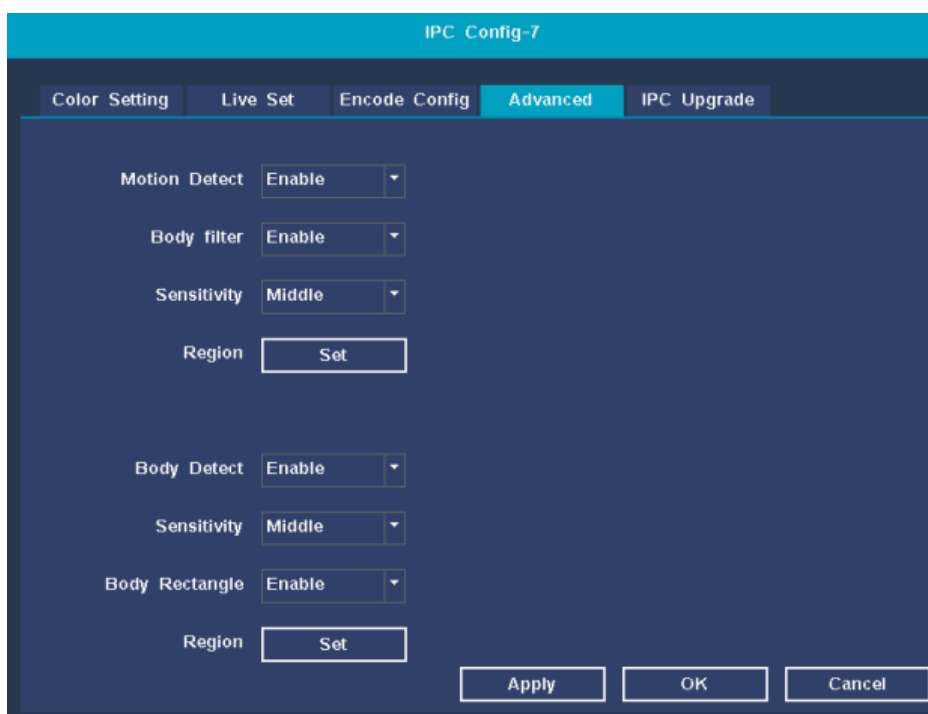

4.4.5 Camera upgrade

Function description: IPC camera program version upgrade.

Operation steps: In the IPC configuration interface, click the **【IPC Upgrade】** title to enter the camera upgrade interface, place the IPC program to be upgraded in the root directory of the U disk, insert the U disk into the NVR host, and refresh the U disk status on the device upgrade interface. Select the program that needs to be upgraded and click Upgrade. The device will automatically restart after the upgrade. **As shown below :**

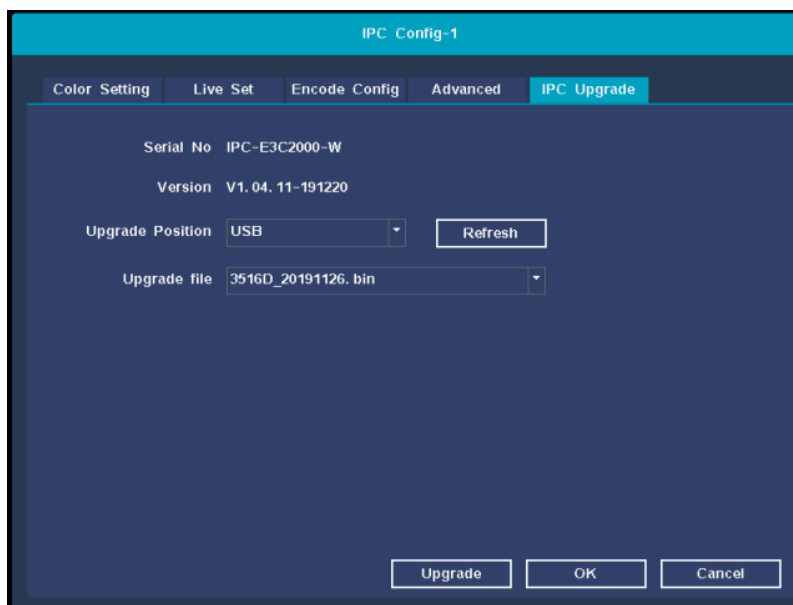

4.5 System settings

System settings main menu: general settings, preview settings, recording plan, recording backup, network configuration, storage management, user management, alarm function, exception handling, restore default, upgrade system The interface is shown below:

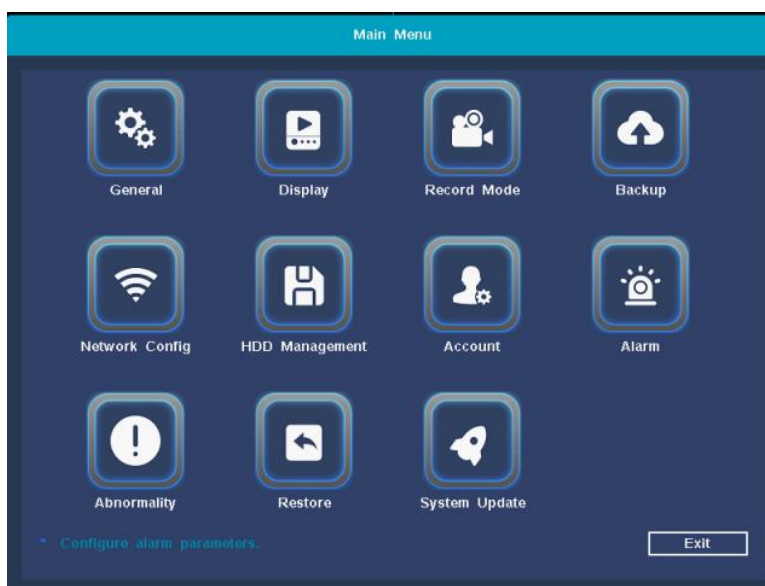

4.5.1. General settings

Function description: set system time, date format, time zone, language selection, resolution, auto logout time, daylight saving time, IPC time synchronization, boot wizard.

【System Time】 Set the current system date and time of the hard disk recorder;

【Date Format】 Choose the format of the date display, including: year month day, month day year, day month year;

【Time Zone】 Choose your time zone;

【Language】 Support multiple languages, with Chinese and English as standards.

【Resolution】 The default resolution is 1280x1024, 1024x768, 1280x720, 1440x900, 1920x1080 optional;

【Auto Logout(m)】 Can set the menu standby time 0-60, 0 is not set standby time;

【DST】 Check the checkbox before daylight saving time to set the start time and end time of daylight saving time.

【IPC Sync. Time】 You can check to enable the IPC time synchronization function, or you can uncheck to turn off the IPC time synchronization function.

Operation steps: Use the mouse to click the option to be modified, switch or manually input the value to be modified, and click the **【Save】** button to take effect.

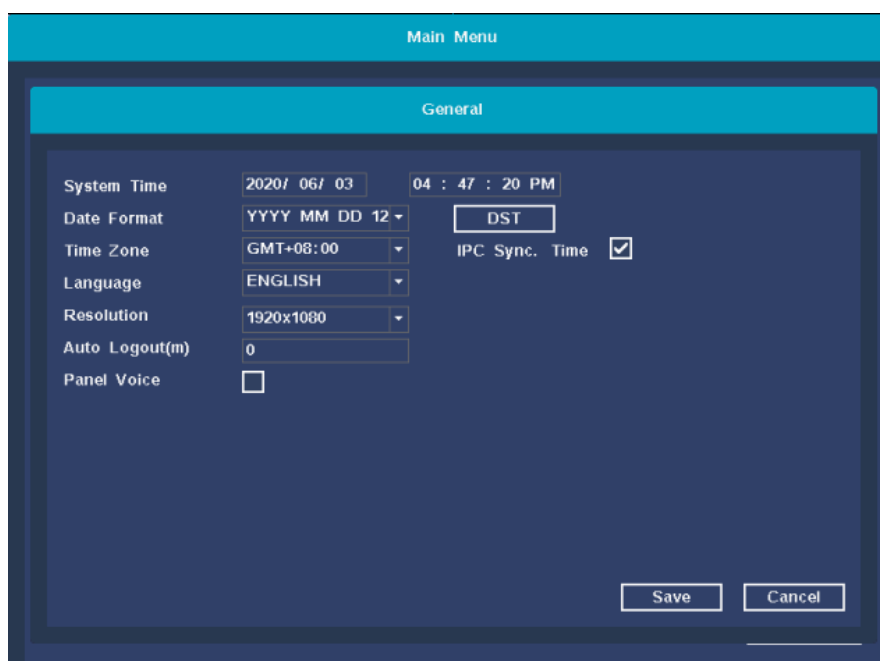

4.5.2. Display

Function description: Set the display parameters of NVR preview interface: channel name, time title, channel title, recording status, alarm status.

【Channel Name】 Click the channel name modification button to enter the channel name menu, you can modify the channel name (maximum support 16 Chinese characters);

【Time title】 The mark indicates selected, and the date and time of the system are displayed on the monitoring screen,

【Channel title】 The mark indicates selected, and the channel number of the system is displayed on the monitoring screen;

【Time title】 and **【Channel title】** Set the time title and channel title colors (white, black, red, green, blue).

【Recording Status】 The mark indicates selected, and the channel recording status is displayed.

【Alarm Status】 The mark indicates the selection and the alarm status is displayed.

【Round Robin】 Click on the round robin to enter the round robin setting interface. You can enable round robin and set the round robin interval time. There are up to 32 round robin schemes. Each round can be customized to add channels that need round robin.

【Tour】 Can set alarm polling time interval;

【Return After The Alarm】 The mark indicates that it is selected. After the alarm is over, the tour will exit and return to the main interface.

Operation steps: Use the mouse to click the option that needs to be modified, check, switch or manually input the value that needs to be modified, and click the **【Save】** button to take effect.

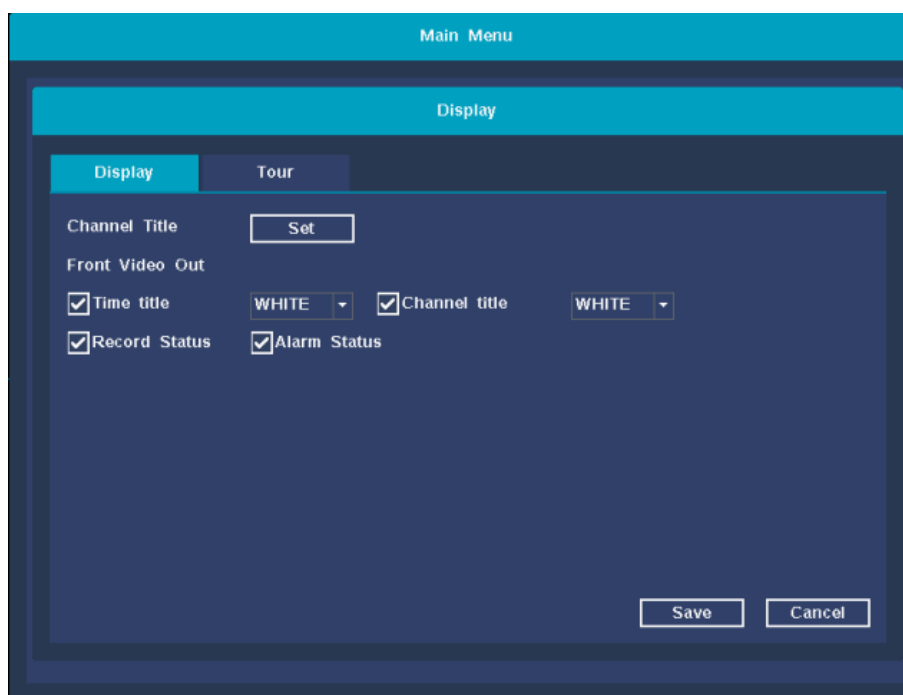

4.5.3. Record Mode

Function description: Set NVR recording plan parameters.

【CAM】 Select the corresponding channel number to set the channel, for all channel settings, select the full;

【Prerecorded(s)】 Record 1-30 seconds before the recording action state occurs (the length of time may vary due to the size of the stream);

【Delay(s)】 After the recording action setting starts, the recording will be delayed for a period of time;

【Audio coding】 The mark indicates that the recording is enabled, and the audio encoding of the recording is enabled.

【Mode Brush】

Timed Record: perform ordinary recording within the set time period

Moving Record: record the motion detection alarm period within the set time period

Not Record: no video will be recorded within the set time period.

【Copy】 Reproduce the recording settings of one channel to other channels.

【Restore】 Restore recording settings to system default.

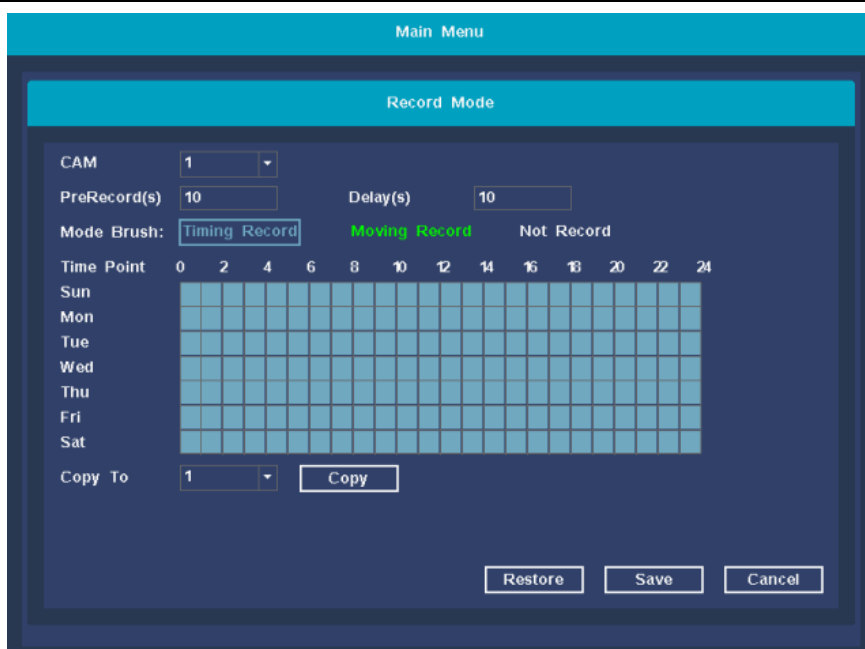

4.5.4. Video backup

Function description: used to backup NVR hard disk video to U disk or hard disk.

Steps: Insert the U disk into the NVR, click the **【detect】** button, after detecting the U disk, click the **【backup】** button to enter the video backup interface, query the channel to be backed up, select the time period to be backed up, query the NVR hard disk video files Select the file to be backed up, click the **【Start】** button to start the backup, the system prompts that the backup is complete.

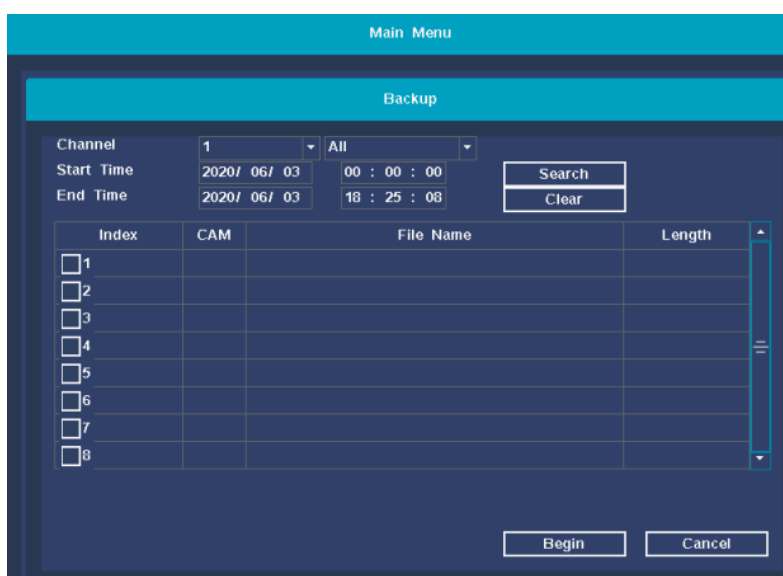

4.5.5. Network settings

Function description: Network settings include: network card, DHCP switch, IP address, subnet mask, gateway, DNS settings. HTTP port, TCP port, P2P ID display, advanced settings.

【Net Card】 Currently only supports wired network cards;

Operation Manual of Wireless NVR Kit

【DHCP Enable】 After checking, automatically obtain the IP function (not recommended); Note: the device needs to be connected to the router. Unchecking requires the user to manually set the IP information.

【IP Addr】 In manual mode, set the IP address of the device;

【Subnet Mask】 In manual mode, set the subnet mask of the device;

【Gateway】 In manual mode, set the default gateway of the device;

【DNS Settings】 The domain name resolution server is used to resolve the domain name into an IP address. The address is provided by the network operator where you are located. After setting the address, you need to restart to take effect;

【HTTP Port】 The default is 80;

【TCP Port】 The default is 6001;

【P2P ID】 You can enable the Tuya UUID/view the Tuya account connection status.

Main Menu

Network

Net Card	Wire Netcard	<input checked="" type="checkbox"/> DHCP Enable
IP Addr	0 . 0 . 0 . 0	
Subnet Mask	0 . 0 . 0 . 0	
Gateway	0 . 0 . 0 . 0	
Primary DNS	192 . 168 . 1 . 1	
Secondary DNS	192 . 168 . 1 . 1	
HTTP Port	80	
TCP Port	6001	
P2P ID:	Set	
Advanced	Set	

OK Cancel

【Advanced】 NVR equipment NTP time, PPPOE setting, Email alarm setting, DDNS setting, Telnet service switch.

Main Menu

Advanced

Net Server	Net Server Info
PPPOE	Stop unknown
NTP	Enable ntp1.aliyun.com
EMAIL	Stop smtp.domain.com
IP Authority	Stop host.domain.com
DDNS	Stop 0.0.0.0
Telnet	Stop 0.0.0.0

Save Cancel

4.5.6. Storage management

Function description: Configure and manage the hard disk in the device. The current hard disk information is displayed in the menu, including the number of connected hard disks, access interfaces, status, and total capacity. The hard disk can be formatted. During operation, select the operation hard disk and click the right function button to execute.

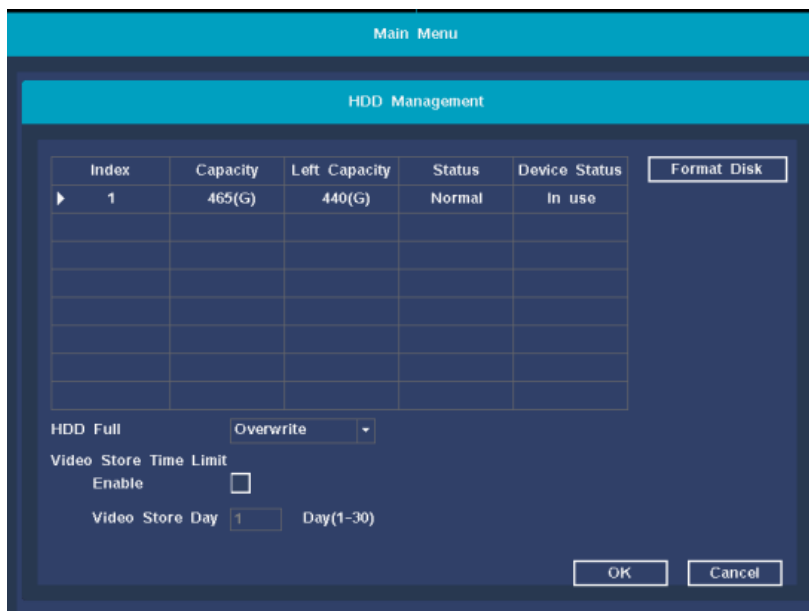

Note: Please turn off the device before installing or replacing the hard disk.

4.5.7. User Management

Function description: User management mainly includes: Add User, Delete User, Modify User, Modify Pwd.

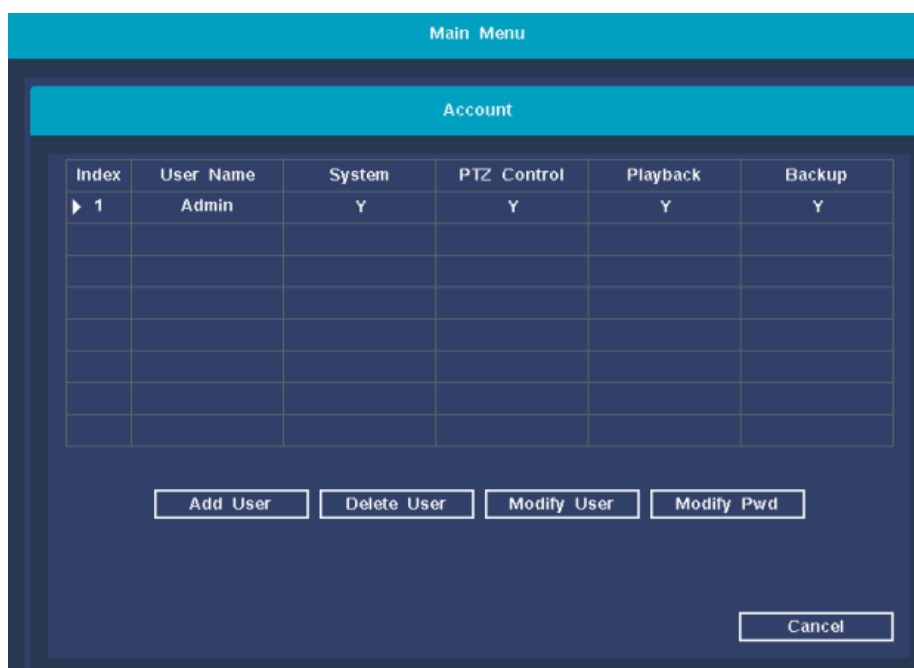

【Add User】 To add a new user, you can set a new user name and password. And permissions configuration.

The screenshot shows the 'Add User' configuration page. At the top, there is a 'Main Menu' bar. Below it, the page title is 'Add User'. The form contains three input fields for 'User Name', 'Password', and 'Confirm'. Below these is an 'Authority Config' section with four checkboxes: 'System', 'PTZ Control', 'Playback', and 'Backup'. At the bottom right, there are 'Save' and 'Cancel' buttons.

【Delete User】 Delete redundant users. By default, reserved users are not allowed to delete.

【Modify User】 Modify the attributes of existing users, the default administrator user cannot be modified;

【Modify Pwd】 Modify the user account password, the password can be set to 1-12 digits.

The screenshot shows the 'Modify Pwd' configuration page. At the top, there is a 'Main Menu' bar. Below it, the page title is 'Modify Pwd'. The form contains four input fields: 'User Name' (pre-filled with 'Admin'), 'Old', 'New', and 'Confirm'. At the bottom right, there are 'Save' and 'Cancel' buttons.

Note: A user with user account control authority can modify the passwords of other users in addition to changing his own password.

4.5.8. Alarm function

Function description: Alarm function settings include: video loss alarm, motion detection alarm, and humanoid recognition alarm function settings.

Video loss:

【CAM】 Select the corresponding channel number to set the channel, and set all channels in a unified way.

【Period】 The device will trigger the motion detection alarm signal within the set time range

【Show Message】 On the NVR preview screen, a dialog box for prompting alarm information will pop up;

【Buzzer】 When the alarm occurs, the device emits two long beeps.

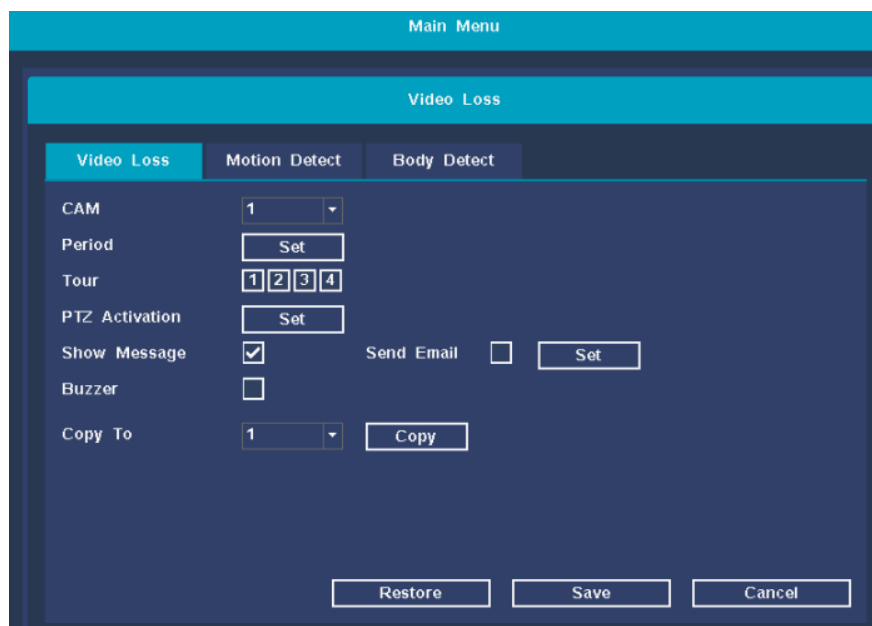

Motion Detect:

【CAM】 Select the corresponding channel number to set the channel, and set all channels in a unified way.

【Period】 The device will trigger the motion detection alarm signal within the set time range

【Delay(s)】 When the video is lost, it means that when the alarm is over, the alarm will stop for an extended period of time, ranging from 10 to 300 seconds;

【Show Message】 On the NVR preview screen, a dialog box for prompting alarm information will pop up;

【Buzzer】 When the alarm occurs, the device emits two long beeps.

【Record Channel】 Select the channel to set the motion detection area;

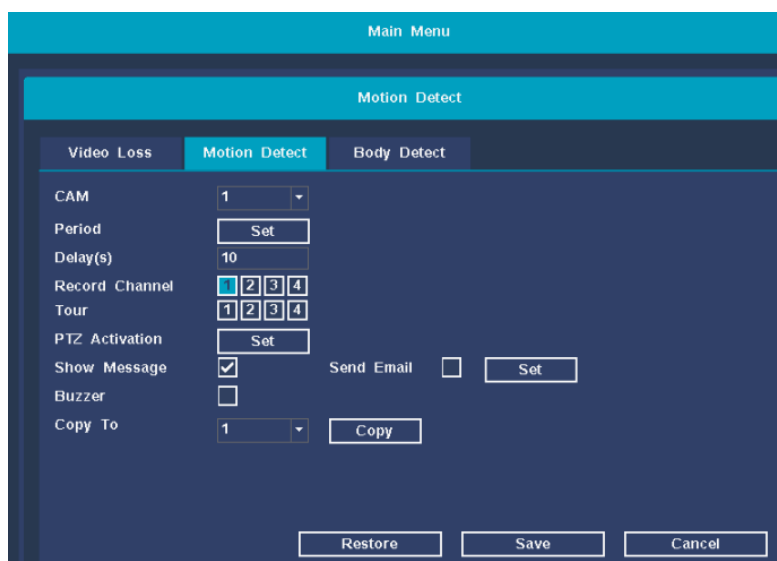

Humanoid recognition alarm:

【CAM】 Select the corresponding channel number to set the channel, and set all channels in a unified way.

【Period】 The device will trigger the motion detection alarm signal within the set time range

【Delay(s)】 When the video is lost, it means that when the alarm is over, the alarm will stop for an extended period of time, ranging from 10 to 300 seconds;

【Show Message】 On the NVR preview screen, a dialog box for prompting alarm information will pop up;

【Buzzer】 When the alarm occurs, the device emits two long beeps.

【Record Channel】 Select the channel to set the motion detection area

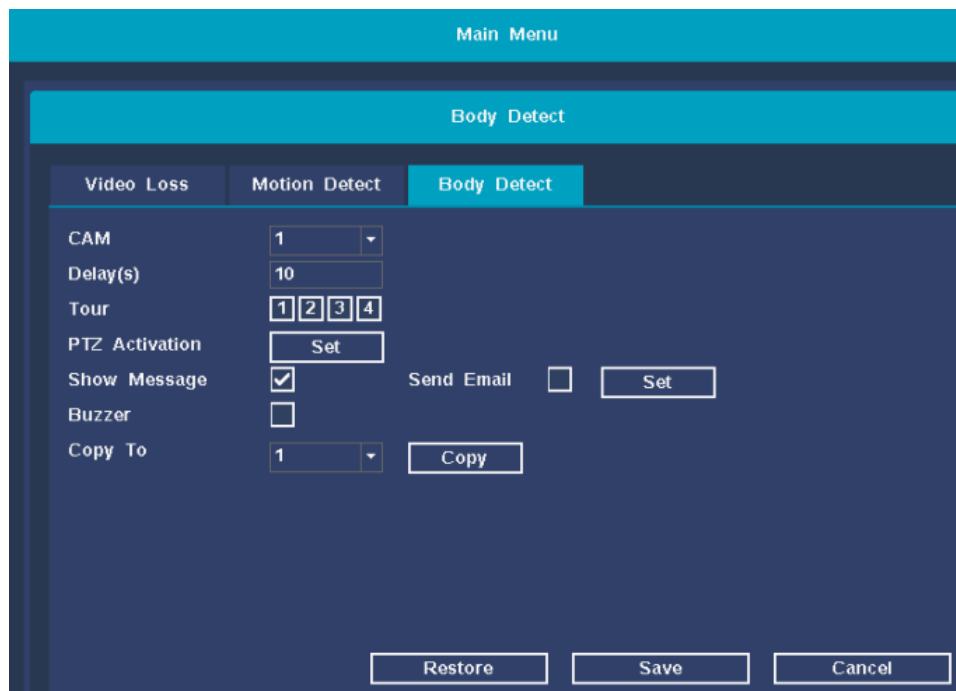

4.5.8. Abnormality

Exception handling includes two cases of hard disk abnormality and insufficient hard disk space.

Disk Error:

When the hard disk space is insufficient, NVR can set two kinds of prompts. As shown below:

【Show Message】 On the NVR preview screen, a dialog box for prompting alarm information will pop up;

【Buzzer】 When the alarm occurs, the device emits two long beeps.

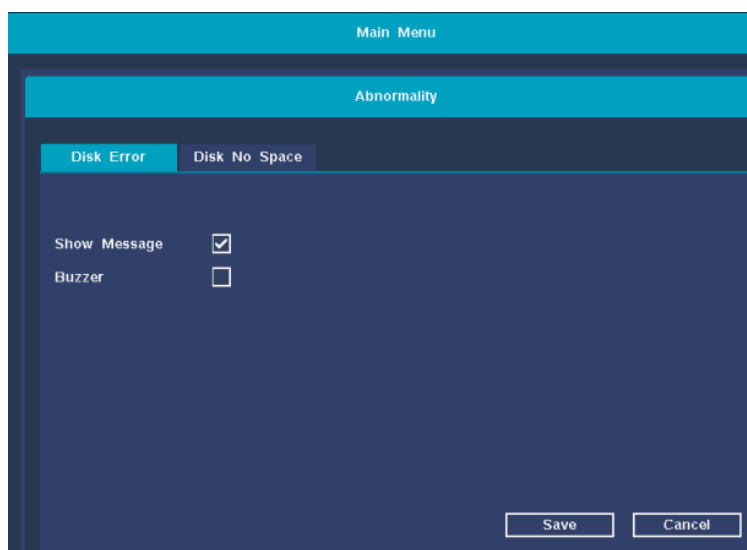

Disk No Space :

When the hard disk space is insufficient, NVR can set two kinds of prompts. As shown below:

【Lower bound(G)】 The hard disk can reserve memory, the range is 5-30G

【Show Message】 On the NVR preview screen, a dialog box for prompting alarm information will pop up;

【Buzzer】 When the alarm occurs, the device emits two long beeps.

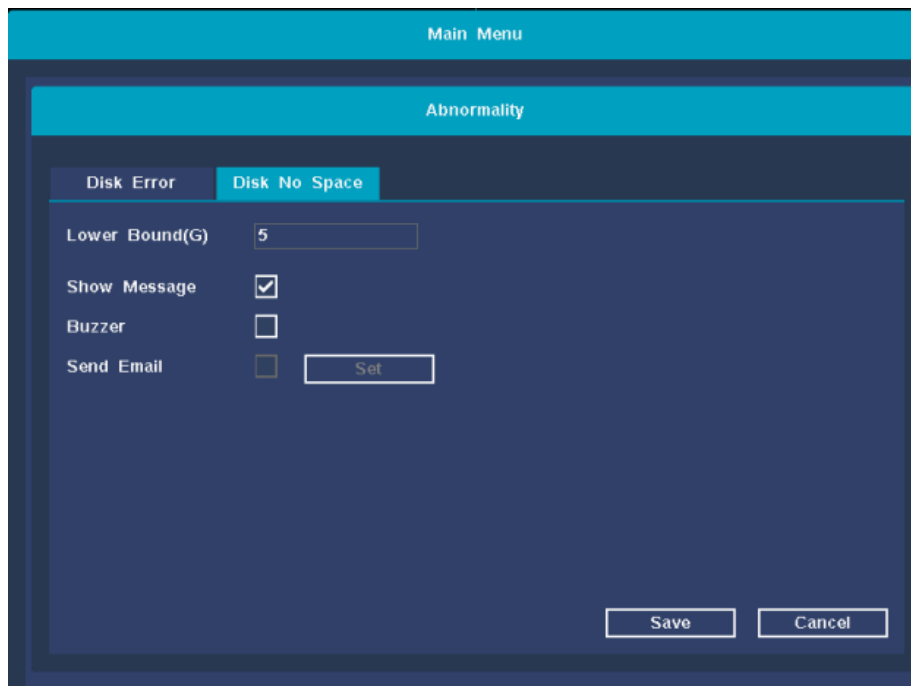

4.5.9. Restore default

To restore the factory default settings, click Restore Default, a prompt box for restoring factory settings pops up, click the **【OK】** button, the device will automatically restart, and the factory reset will be completed after the restart is completed.

As shown below :

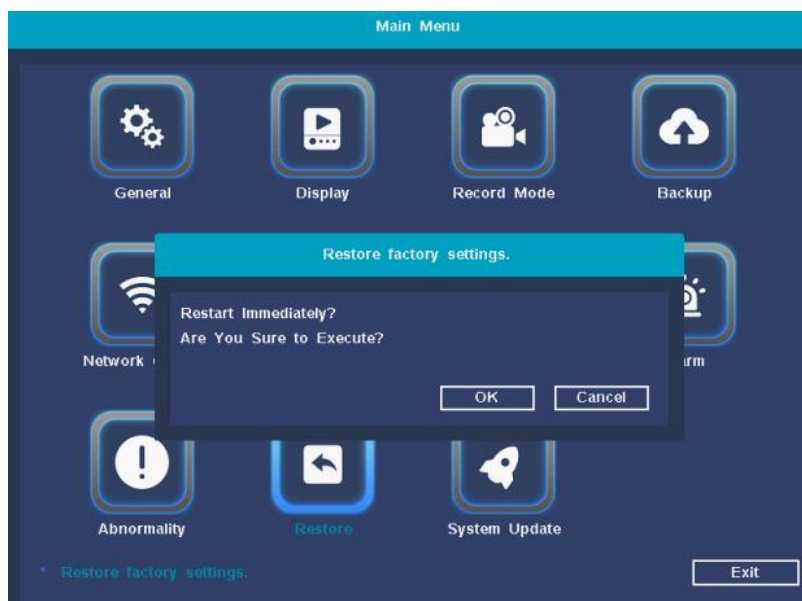

4.5.10. Upgrade

Function description: Upgrade NVR main program and NVR WiFi module program

【Upgrade Position】 Select USB interface;

【Upgrade file】 Select the program to be upgraded. Click upgrade, the device restarts after the upgrade is complete.

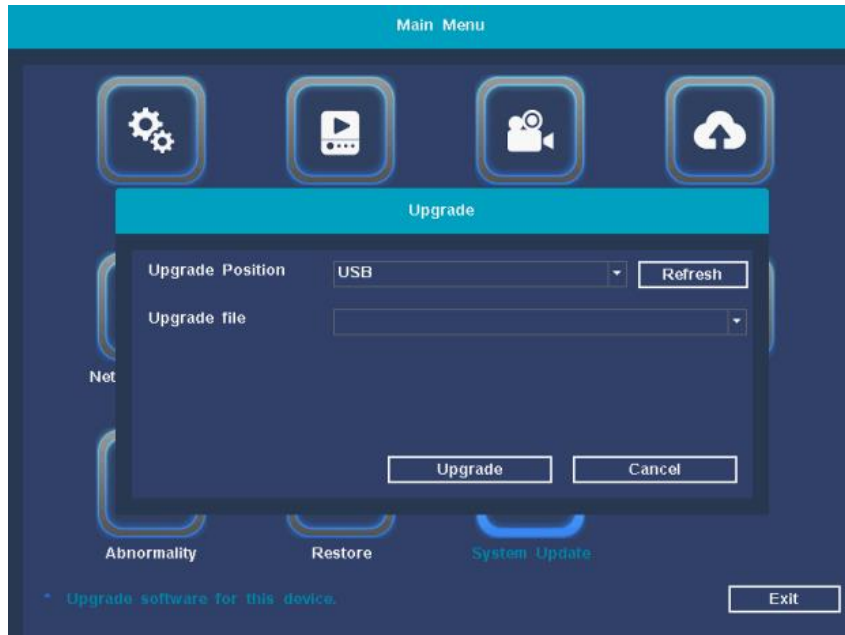

4.6 Video playback

Function description: Play back the video files in the hard disk. You can enter the video playback interface through the shortcut menu of the right mouse button and click the **【Video Playback】** option, as shown in the following figure:

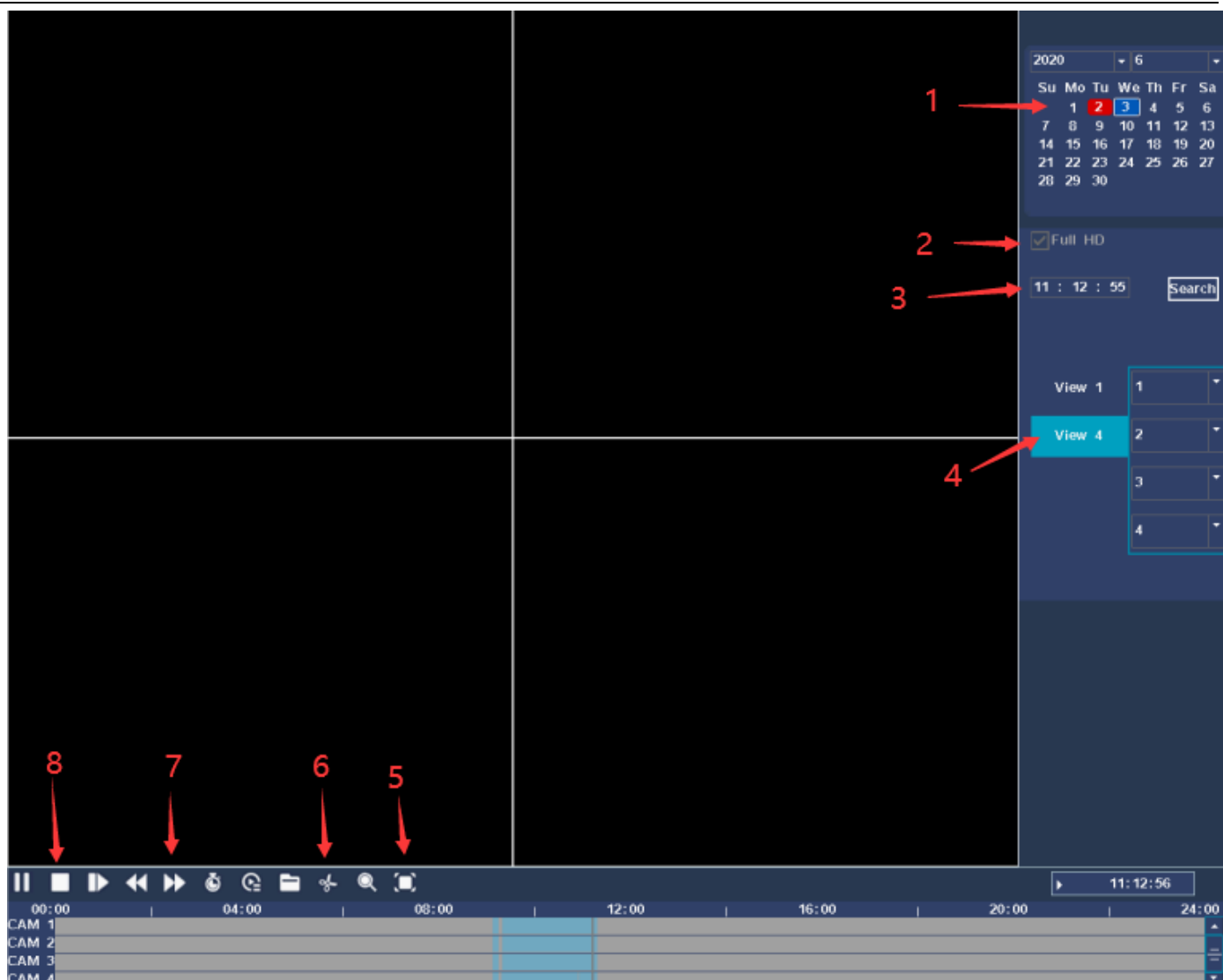

- | | | | |
|----------------------------|-----------------------|--------------------------|-----------------------------|
| 1. Time and date | 2. Full HD | 3. Time selection | 4. Channel selection |
| 5. Full screen mode | 6. File backup | 7. Play ratio | 8. Stop playback |

【Time and Date】 Select the time and date. The date with a white border is the current system date; the date with a red background indicates that there is a recording on the current date.

【Full HD】 Select sub-stream playback/mainstream playback.

【Time selection】 Choose a good time and date, you can search for a specific time recording

【Channel Selection】 Select the specified channel to record.

【Full Screen Mode】 Mouse click all full screen to enter the full-screen playback interface

【File Backup】 Jump to the backup interface for the backup operation. Click the button to pop up Figure 3.5, you can follow the instructions below. Note: Before backing up files, you need to install a storage device that is sufficient to hold

the stored files; the backup is terminated midway, and files that have been copied to the storage device can be played back independently.

【Play ratio】 Display the speed multiple of fast or slow playback.

【Stop playing】 Video recording stops playing.

4.7 PTZ control (reserved function)

Function description: Use the NVR to control the camera pan/tilt rotation, zoom, preset position, cruise and other operations.

Operation premise:

Before users control the IP camera or PTZ, please make sure that the camera supports PTZ control function and the network with the NVR has been connected normally.

Steps:

1. Right-click on the main interface and select PTZ control in the shortcut menu to enter the PTZ control interface. As shown below:
2. Support PTZ direction control, zoom, focus, iris adjustment, preset call, you can enter the sub-menu to set the cruise path, run cruise.

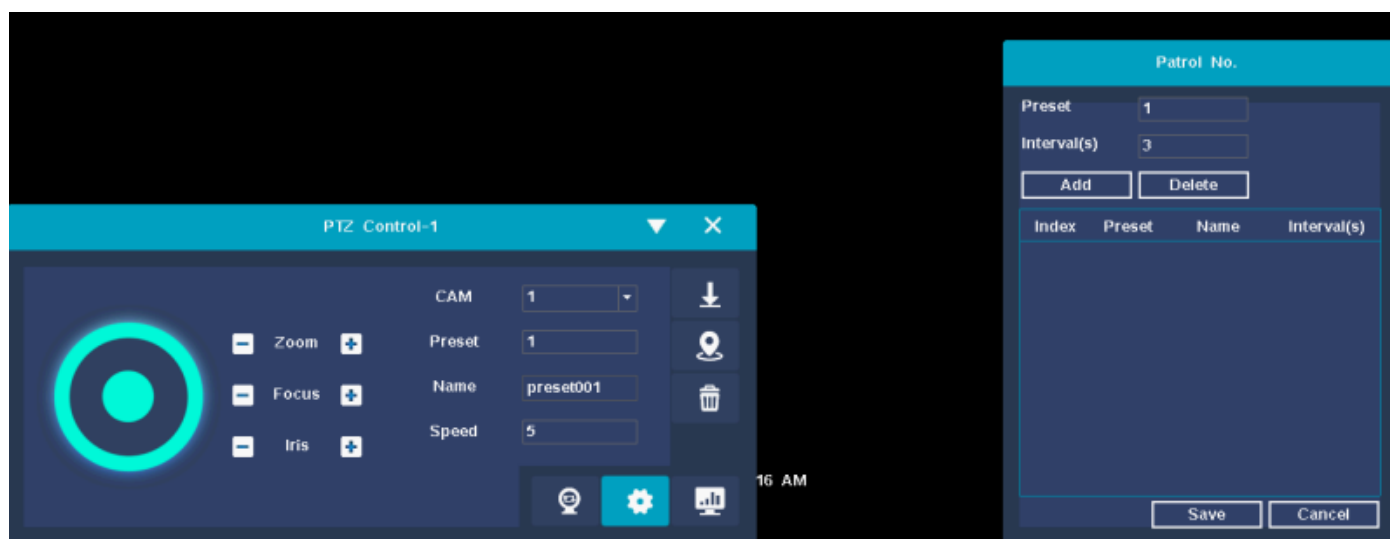

Special Note: At present, this function is only reserved for NVR. The camera does not support the PTZ control function at the moment. Cameras that support PTZ control will be launched later.

4.8 system message

Function description: System information bar, you can view device log information, stream information, version information, and online user query.

4.8.1 Log information

Operation steps: Through the right mouse button shortcut menu, click **【System Information】** and then click **【Log】** to enter the log information query interface, as shown in the following figure.

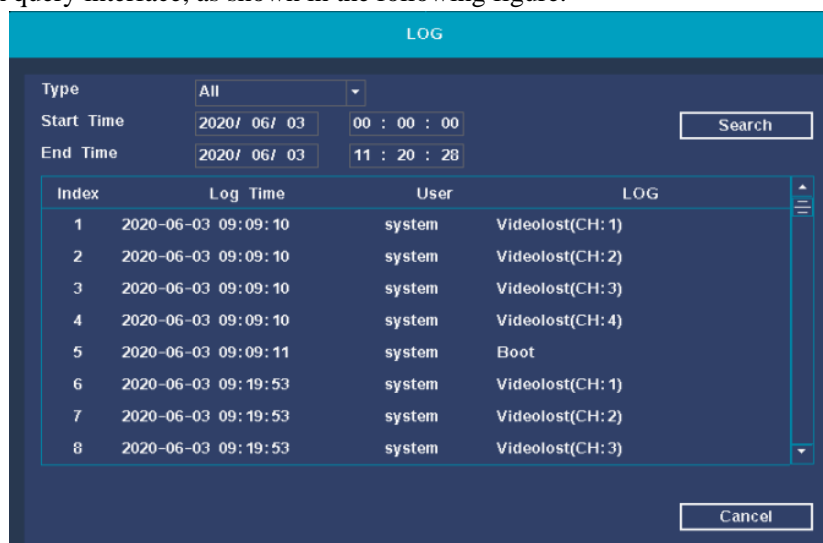

4.8.2 Stream statistics

Function description: Query the recording status, stream status, frame rate information and resolution information of each channel.

Operation steps: Right-click the shortcut menu, enter the **【System Information】** interface, select **【BPS】** option, enter the code stream statistics interface, as shown in the title:

The screenshot shows the 'BPS' interface with a table of stream statistics for four channels. The table has columns for Channel, Record Status, Bit Rate(kbps), Frame Rate(FPS), and Resolution.

Channel	Record Status	Bit Rate(kbps)	Frame Rate(FPS)	Resolution
D_01	RECORD	426 Kbps	15 F/S	1080P
D_02	RECORD	632 Kbps	15 F/S	1080P
D_03	RECORD	477 Kbps	10 F/S	1080P
D_04	RECORD	569 Kbps	15 F/S	1080P

4.8.3 Version information

Function description: Query NVR version information, serial number, chip information.

Operation steps: Use the right mouse button shortcut menu to enter the **【System Information】** interface, select the **【Version】** option to enter the version information interface, as shown below.



4.8.4 online user

Function description: Query online login user name, IP, login method.

Steps: Right-click the shortcut menu, enter the **【System Information】** interface, select the **【Online User】** option, and check the status of the online user.

4.9 Shut down the system

Function description:

The system shutdown options include: Restore, logout, Shutdown, Reboot.

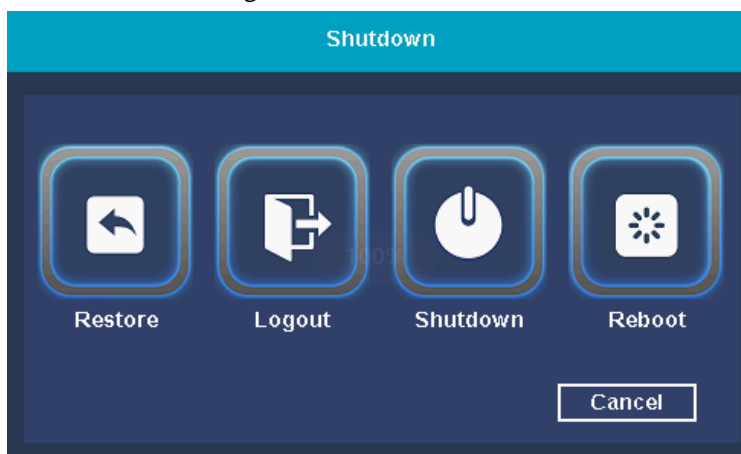

Note: The system-related operations have been described in detail in the previous boot wizard, and will not be repeated here.

4.10 Four screen switching

Function description: Multi-screen switching. Currently, the 4CH WiFi kits have only 4 screens to choose from, and it can be switched to 4 screens from a single-screen state. 8CH WiFi kits can switch among single screen, 4 screens and 8 screen switching.

5 Mobile P2P access

5.1 One-click Internet

Function description: enable or disable P2P remote function, check the status of tuya P2P, APP download QR code, cloud ID QR code display, P2P users unbind.

Operation steps: On the NVR preview interface, click the **【QR code】** in the upper right corner of the mouse to open the **【One Button Internet Access】** interface. As shown below:



5.2 Mobile APP access

Function description: Access the management device through the mobile phone APP.

Steps:

Step 1: Use the mobile phone to scan the QR code to download and install the Tuya APP software;



QR code for download the APP



Interface of tuya APP

Step 2: The first time you use the application, you will need to create a user ID.

Steps as follows:

Click the **【Create New Account】** button → check "Please read and agree to the relevant terms" to enter the registration interface → enter the mobile phone number or email address → enter the verification code → enter the set password → click the **【Finish】** button to register → after registration Log in to the main interface automatically.

Note: When you forget your password, please click **【Forgot Password?】** Button, follow the prompts to send the password to the registered mailbox.

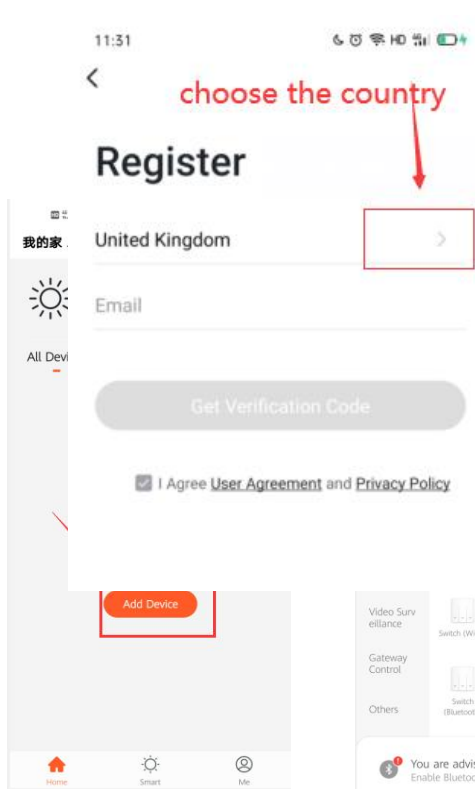

account register

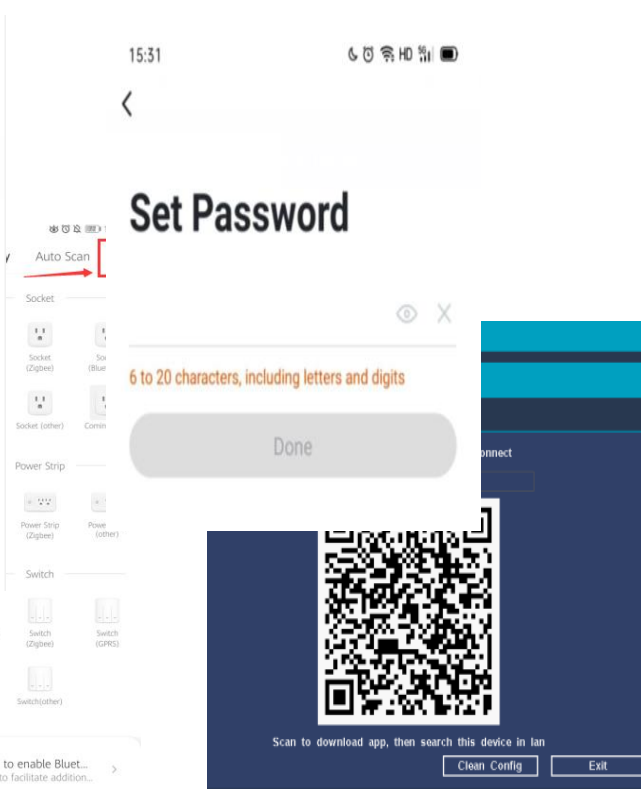

password setup

Step 3: Add devices. Click the upper right button **+** on the main interface of Tuya APP or **【add device】** button to



6. Appendix

6.1 Hard disk capacity unit conversion

Capacity unit conversion for this device		Operating system capacity conversion	
B	1 B = 8 b	B	1 B = 8 b
MB	1 MB = 1000 KB	MB	1 MB = 1024 KB
GB	1 GB = 1000 MB	GB	1 GB = 1024 MB
TB	1 TB = 1000 GB	TB	1 TB = 1024 GB

Note: The capacity conversion method of this machine is the same as that of hard disk manufacturers, and all adopt 1GB=1000MB.

6.2 Calculation of required capacity for recording

- Hourly video file size of single channel image: $A=B\div 8\div 1000\times 3600$
- Daily file capacity of videos for N channels image (record 24 hours): $A=B\div 8\div 1000\times 3600\times 24\times N$
- File capacity of n-way image recording in D days: $A=B\div 8\div 1000\times 3600\times 24\times D\times N$
- A is the required hard disk capacity, B is the code rate, N is the number of recording channels, and D is the number of recording days.