

HD Wireless Wifi Mini PTZ Dome Camera

USER MANUAL

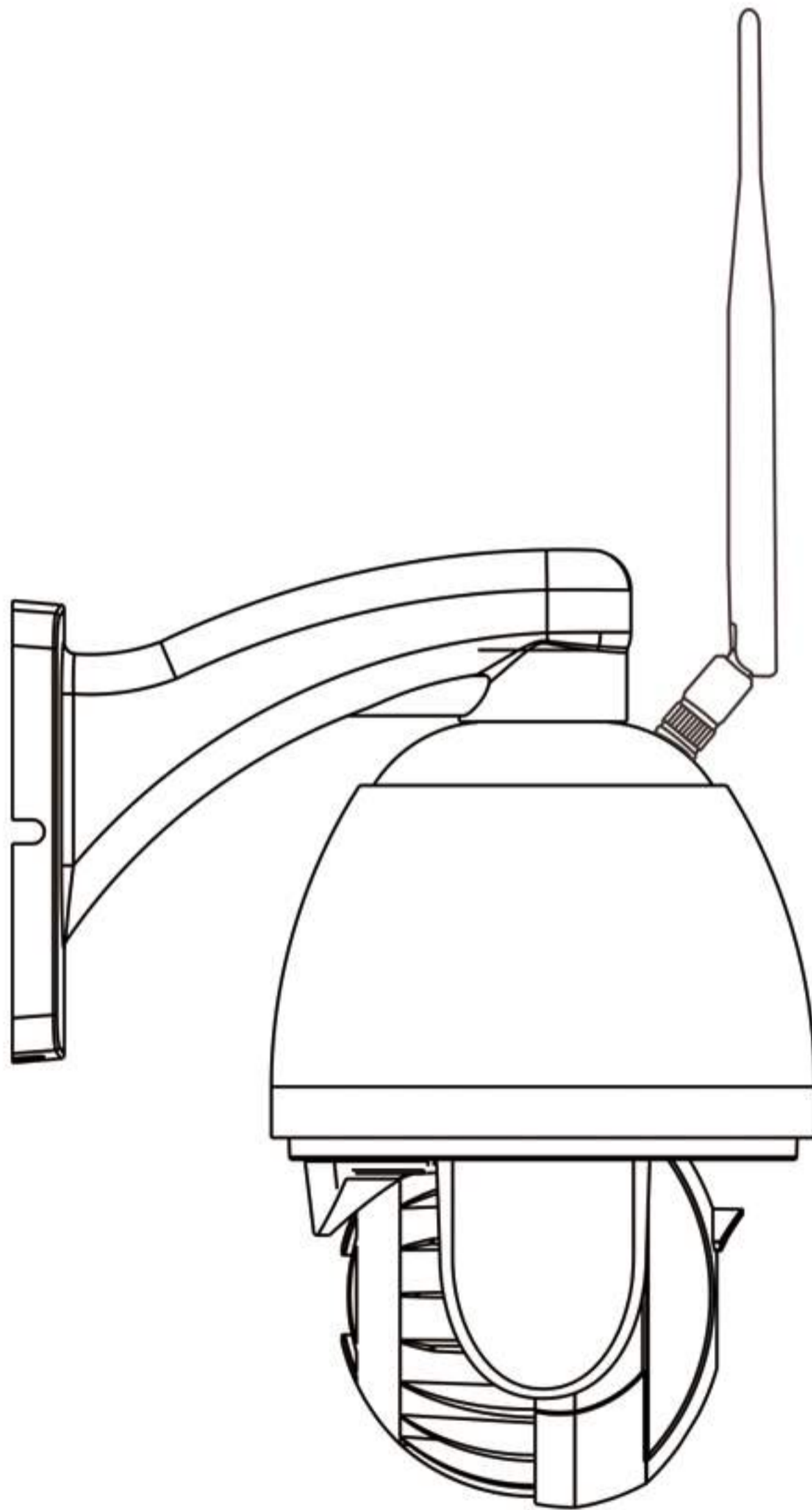

Phone's APP

Respect customer, welcome to choose our product, before using it, please be sure to read the instructions, and save the operation guide for future reference.

CONTENTS

NOTE:	1
--------------------	---

Fast connection for cellphone

1. Connection diagram	2
2. App installation for phones	2
3. The connection of Access Point	3
4. Add camera	3
5. WIFI connect for camera	4
6. Delete Camera	5
7. Functional Specification of APP	6
7-1. Interface specification	6
7-2. Video graphic interface description	7
7-3. Photo check	8
7-4. Video Viewing	8
8. Parameters Settings	9
8-1. Edit Password	9
8-2. Alarm Setting	9
8-3. Action with Alarm	10
8-4. Timing Record	10
8-5. Audio Setting	11
8-6. Video setting	11
8-7. SD Card setting	12
8-8. Time Setting	12
8-9. Email Setting	13
8-10. FTP Setting	13
8-11. System Setting	14
8-12. Device Information	14

PC App Instructions

1. Connection Diagram	15
2. PC App Download and installation	15
3. PC App Details	16
3-1. Login and Introductions	16
3-2. Instructions of interface	16
3-3. Device management	18

3-4. Image & videos Preview	20
3-5. PTZ control	21
3-5-1. PTZ Control	21
3-5-2. Preset Setting	22
3-6. Record Management	23
3-6-1. plan of record	23
3-6-2. Manual Record	24
3-7. Local playback	24
3-7-1. playback by time searching	24
3-7-2. playback by searching file	25
3-8. Remote playback	26
3-9. Parameter Setting	26
3-9-1. Video	27
3-9-2. Image Setting	27
3-9-3. Audio	28
3-9-4. Alarm Setting	28
3-9-5. Network Setting	30
3-9-6. SD Card	30
3-9-7. Timed Capture	31
3-9-8. PTZ	31
3-9-9. Login Info	31
3-9-10. System	31
3-9-11. WIFI	32
3-10. User Management	32
3-10-1. Steps of Adding User	33
3-10-2. Delete user	33
3-10-3. modify user permissions	33
3-10-4. modify user password	33
3-11. Other settings	33
3-12. Logs	34
3-12-1. Log retention time	35
3-12-2. Log query	35
3-12-3. Log backup	35

Quick connection for Internet explorer viewing

1. To find the IP Address of the camera	36
2. View from the Internet Explorer	37
3. IE View Setting	37

Others

1. Installation Instructions for wall mounting	38
2. The position of TF card	39
3. Comparison for different functional cameras	39
4. How to export the videos which storaged in the TF card	40
4-1.the steps to export the videos from TF card	40
4-2.The conversion of video format	41
5. Restore the factory Settings	42
6. upgrade	42
7. The functions for 4G camera	42
8. Access point	43

NOTE:

- 1.The cable end of DC 12v adapter can't be extended, otherwise will lead to power shortage, then burn out the mainboard. If install the camera outdoor, the adapter should be protected by the waterproof box.
- 2.Both ceiling and wall installation suit for indoor, but for outdoor, only wall installation is permitted, and must make sure the bracket is in right position, otherwise the water easy to enter the inside of camera.
- 3.Before install the camera, test it first. Don't mount the bracket as test the camera to avoid the screw scratch the top slot of the camera (The scratched camera will not enjoy free returns).
- 4.Please ensure that the WIFI signal strength is above 90%, if the signal is weak, please replace it with the high-powered WIFI routers or select cable connection.
- 5.For the security of your personal monitoring, after install, please timely modify the password, and remember the new password. if you forget your password, please press reset button up to 20s, it will restore to default Settings and reset the password and other related function.
- 6.The camera comes with preset cruise, which can just set at the PC APP or PC IE browser, The details please refer to Page 22.
- 7.For fully functional camera, the alarm setting can just be made in IE interface through computer, The details please refer to Page 41.
- 8.The camera comes with power supply, bracket, mounting screws, and instruction book. Some cameras will be equipped with pick-up and sound and light alarm. More detailed accessories, please contact the sales service.

Fast connection for cellphone

1.Connection diagram

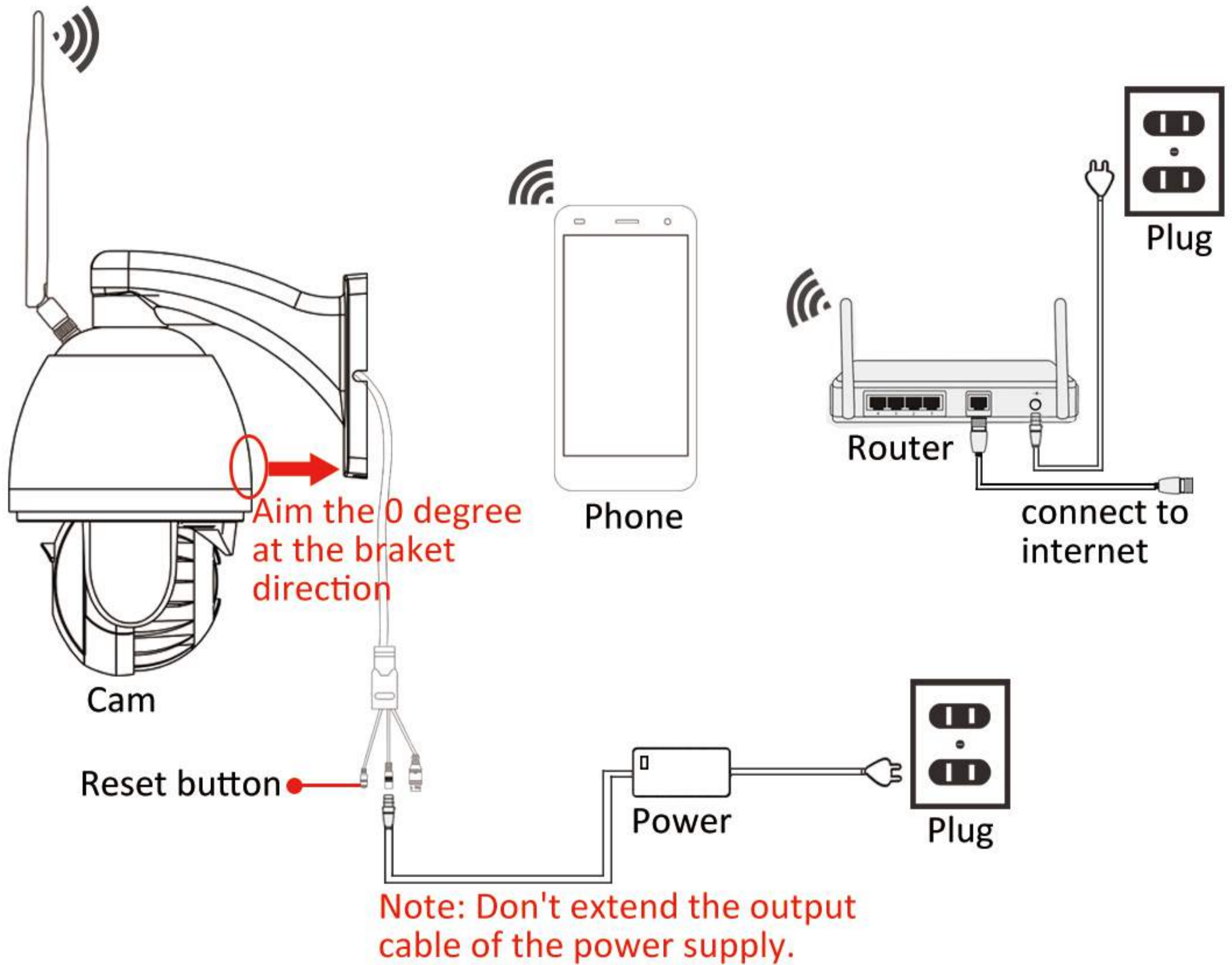



2.App installation for phones

First, ensure the phone already in the Network coverage (4g/wifi), then scan below QR code and download the "CamHi" App to install it. or you can also search "CamHi" in the APP store and install it.



The QR code of APP for Iphone/Android

3.The connection of Access Point

As the camera given power supply, it will automatically rotate for self-checking (up and down, left and right rotation once time). After 1 minute, The camera will generate a wifi number which initial parts are “IPCAM”. Then go to the camera WLAN setting to find this AP number IPCAM-XXXXXX, click connect(as picture 3-1), if it is in lock,  fill the password “01234567”, if it is unlock,  password is empty. (As picture 3-2), the phone already successful connect to the camera AP.

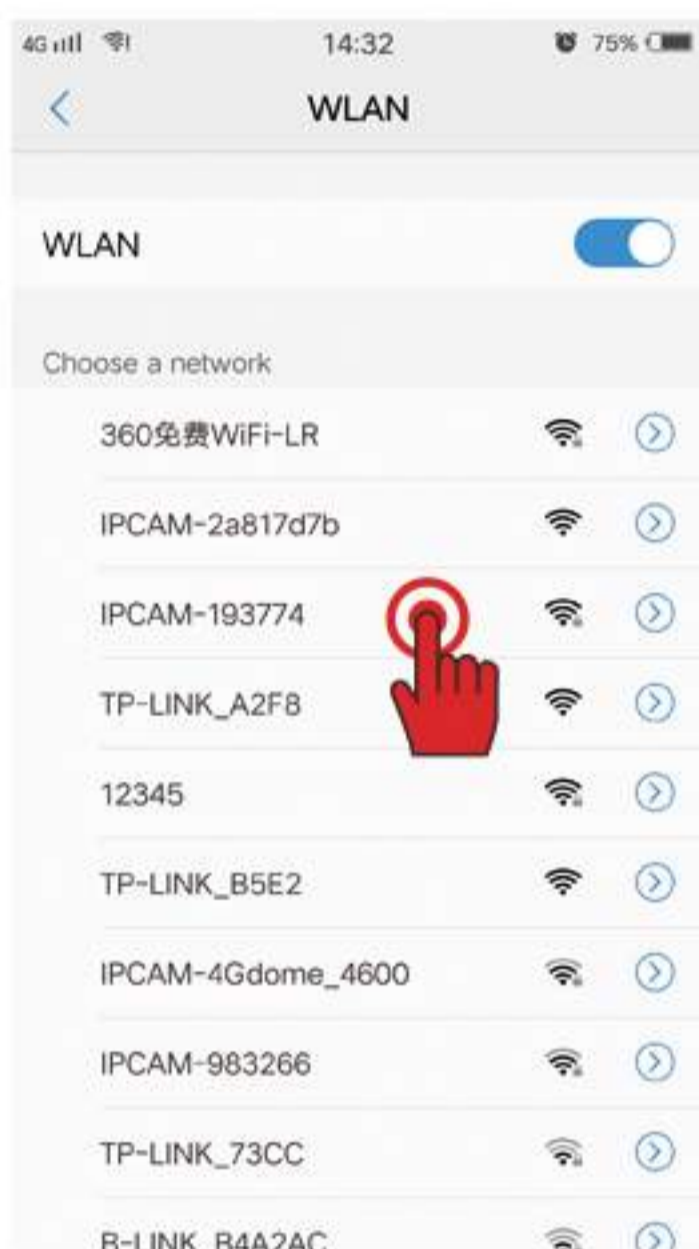



(picture 3-1)



(picture 3-2)

4.Add camera

Open the APP “CamHi” and enter into the operation interface, click “” (As the picture 4-1), then click “” (As picture 4-2), the devices list will pop-up, choose the device you want to add.

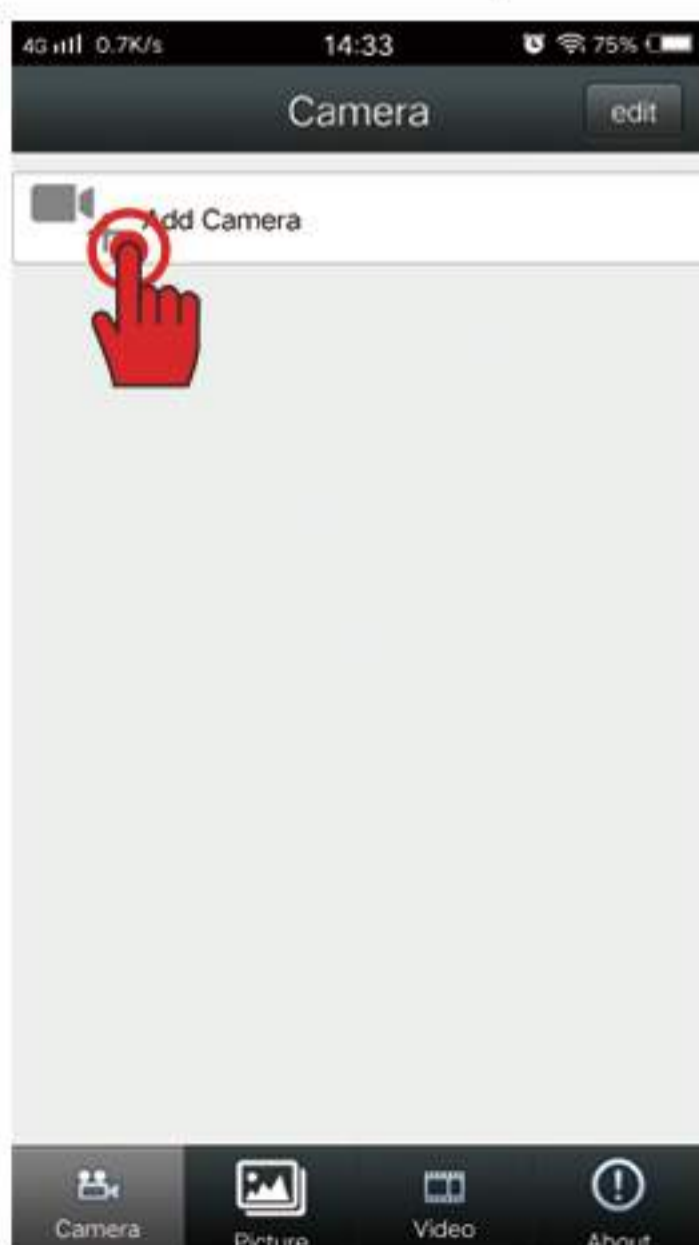

(picture 4-1)

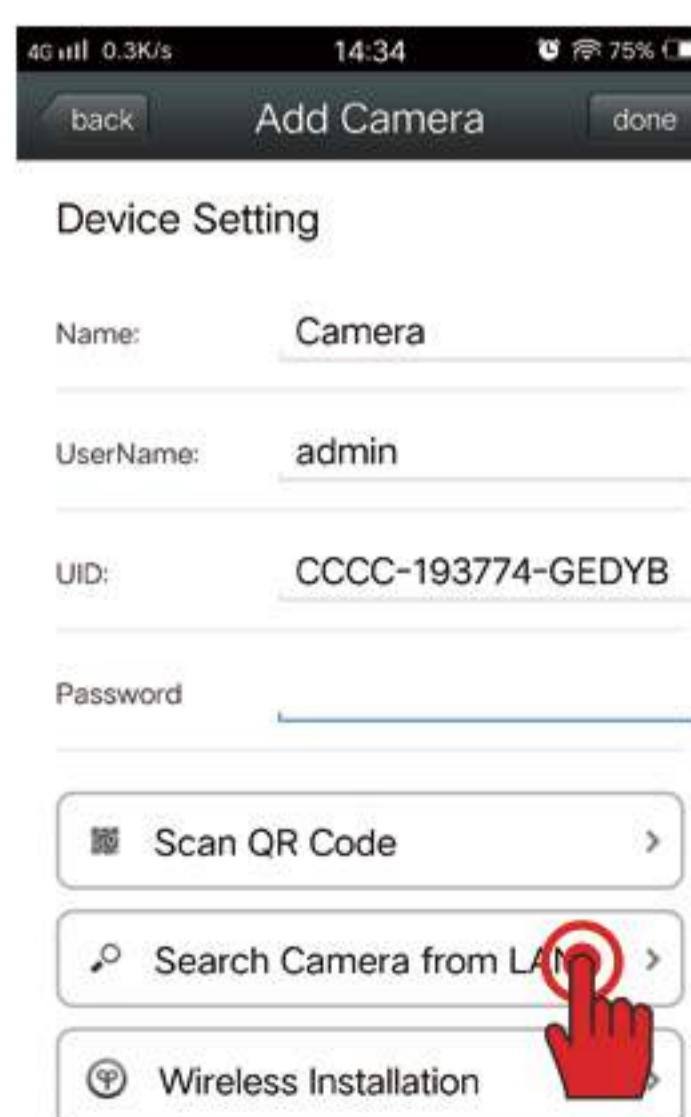

(picture 4-2)

Click the device UID, and input the default password “admin” (as picture 4-3), click “Done”, then back to the device list and click the “camera” to view the video image(As picture 4-4).

Remark: If the camera already connected to the internet, just fill the UID and password at the device setting directly, the camera will be added successful.



(picture 4-3)

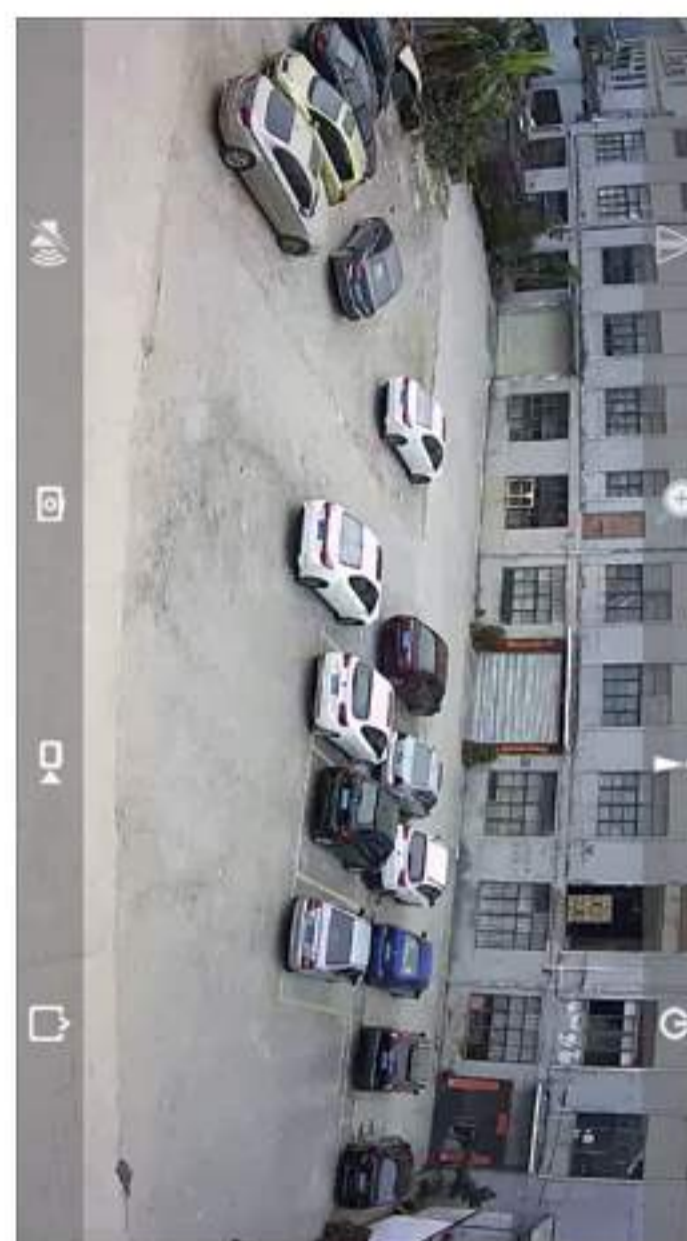

(picture 4-4)

5. WIFI Connection for camera

Click the “camera” enter into the main interface, then select the “Edit”-click the icon of “⚙️”--“wi-fi setting”, Please refer to picture 5-1 and picture 5-2

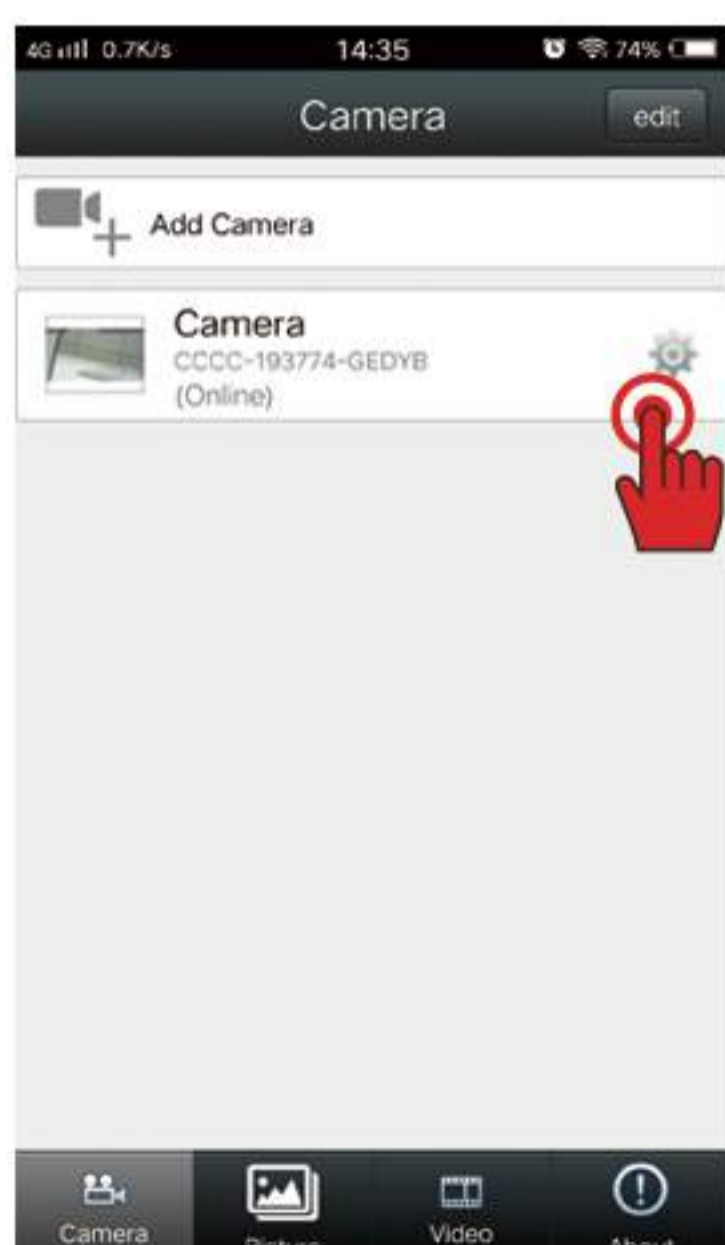

(picture 5-1)

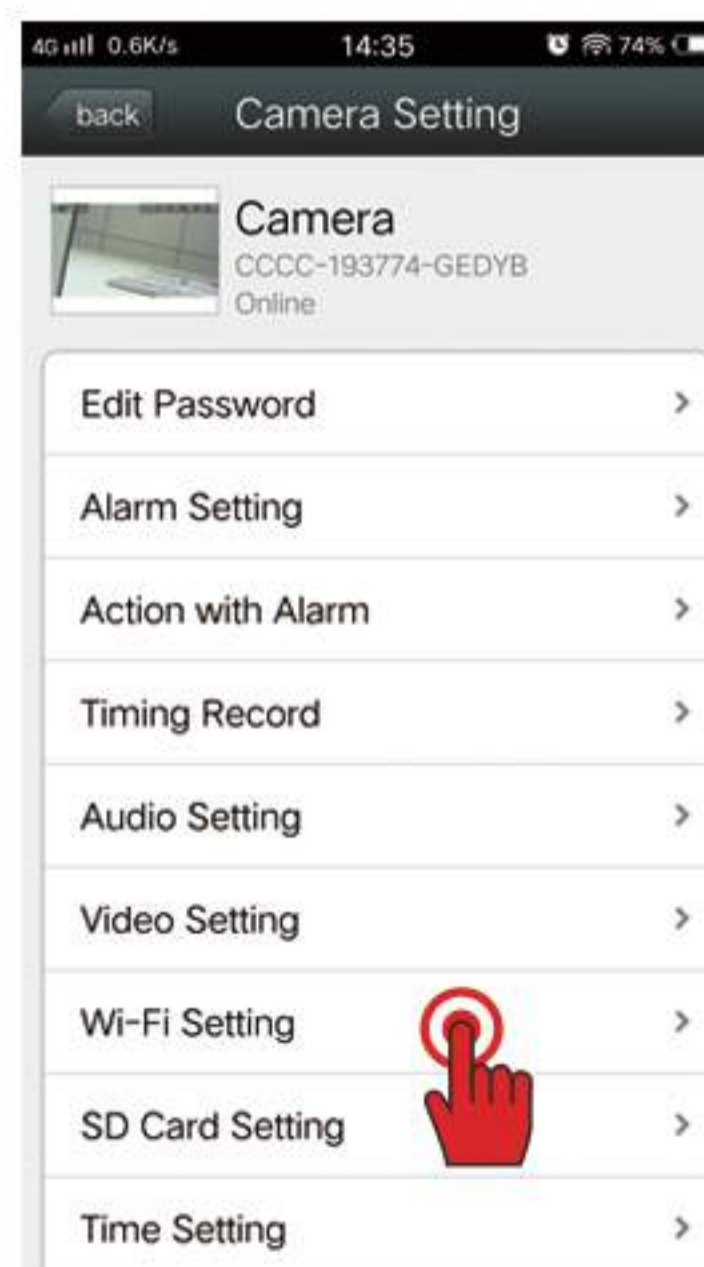

(picture 5-2)

Find “WI-FI manager”(As Picture 5-3)-then choose the right wifi name you want to connect(please ensure the wifi signal above 90%, the wifi name and password in normal characters such as numbers and letters to avoid failure connection), Input the right wifi password to connect(As Picture 5-4). If the box which in front of the wifi name is ticked, means the camera already successful connected to WIFI internet.(warm prompt: the AP mode will disappear as the configuration of WIFI made, if you want to use back the AP mode, Please press the reset button to 20s to restore the camera to default.)



(picture 5-3)

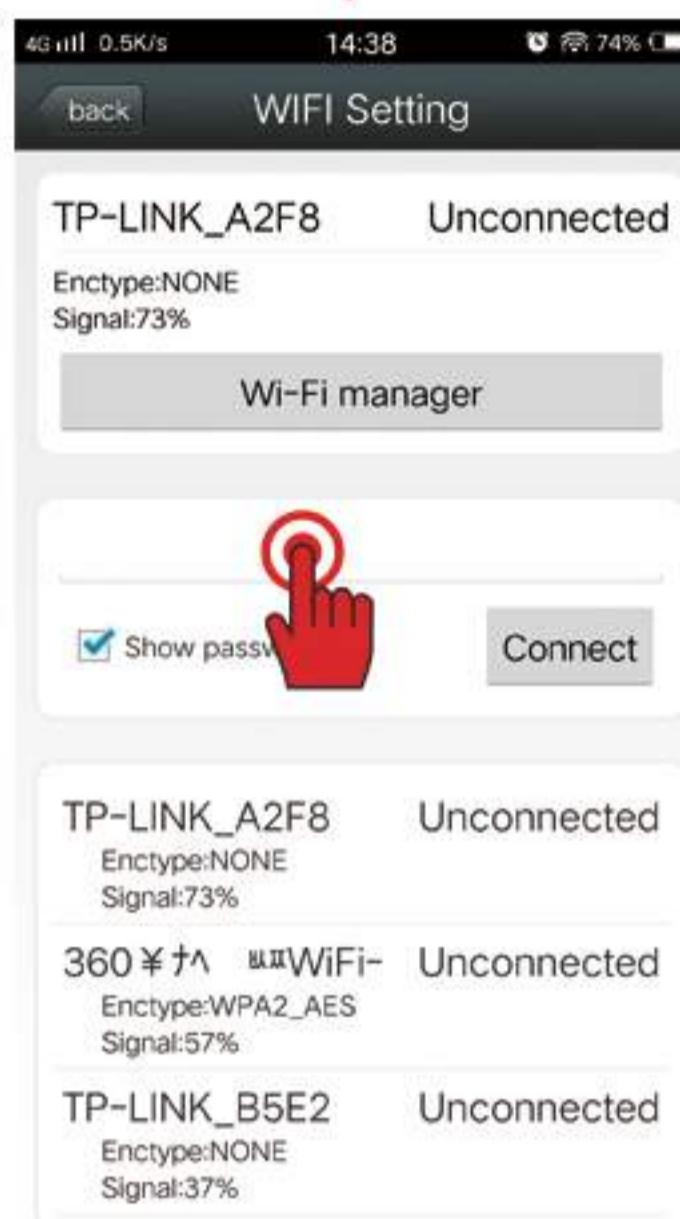

(picture 5-4)

6.Delete Camera

Click “camera” back to the main interface(As picture 6-1), click “Edit” then will come out a icon of delete in front of the cameras(As picture 6-2),and choose the device you want to remove, click delete and “OK”(as shown in figure 6-3).



(picture 6-1)

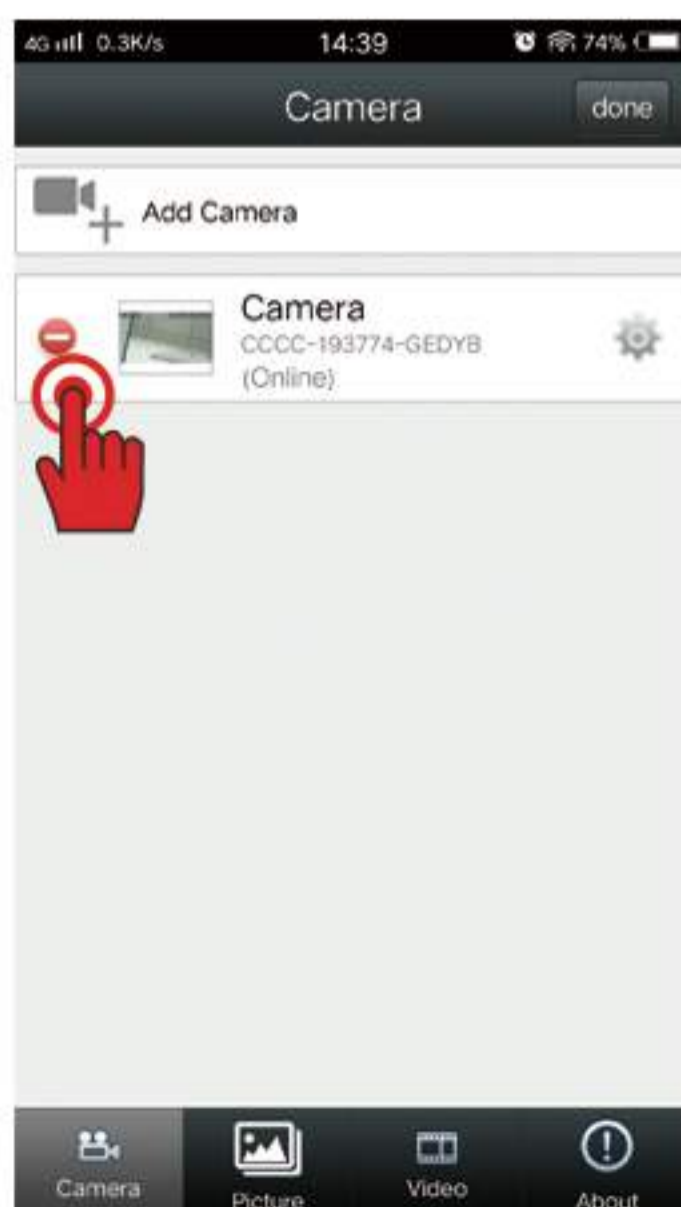

(picture 6-2)

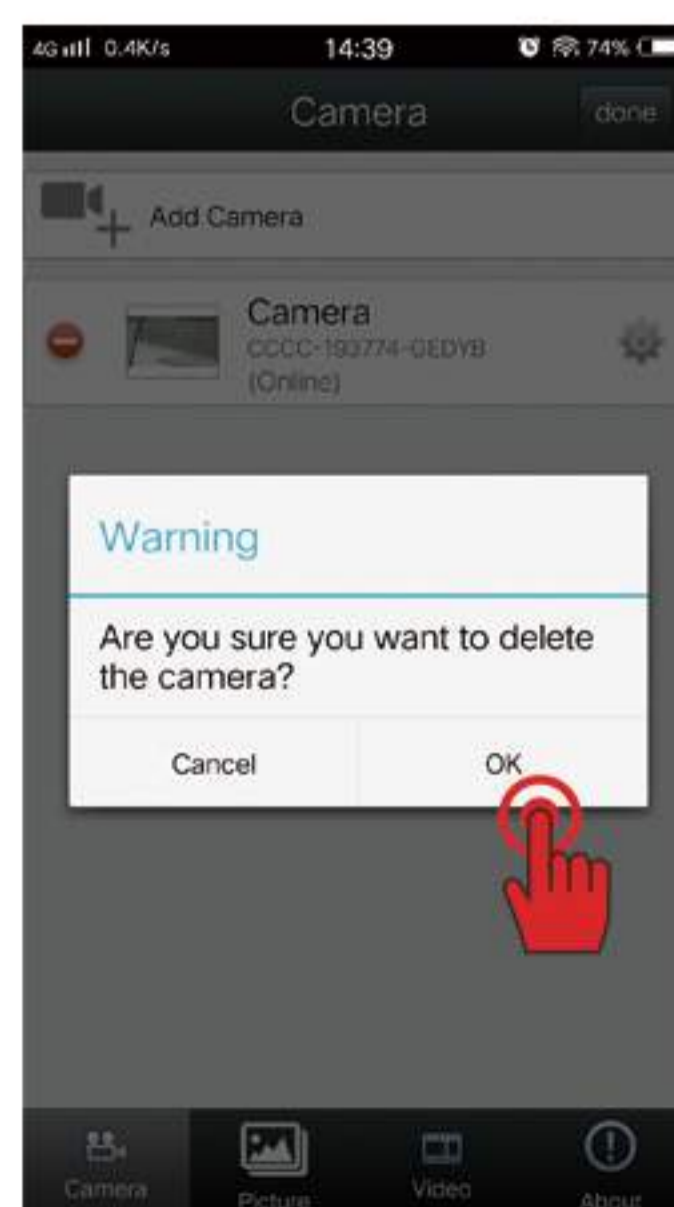

(picture 6-3)

7.Functional Specification of APP

7-1. Interface specification

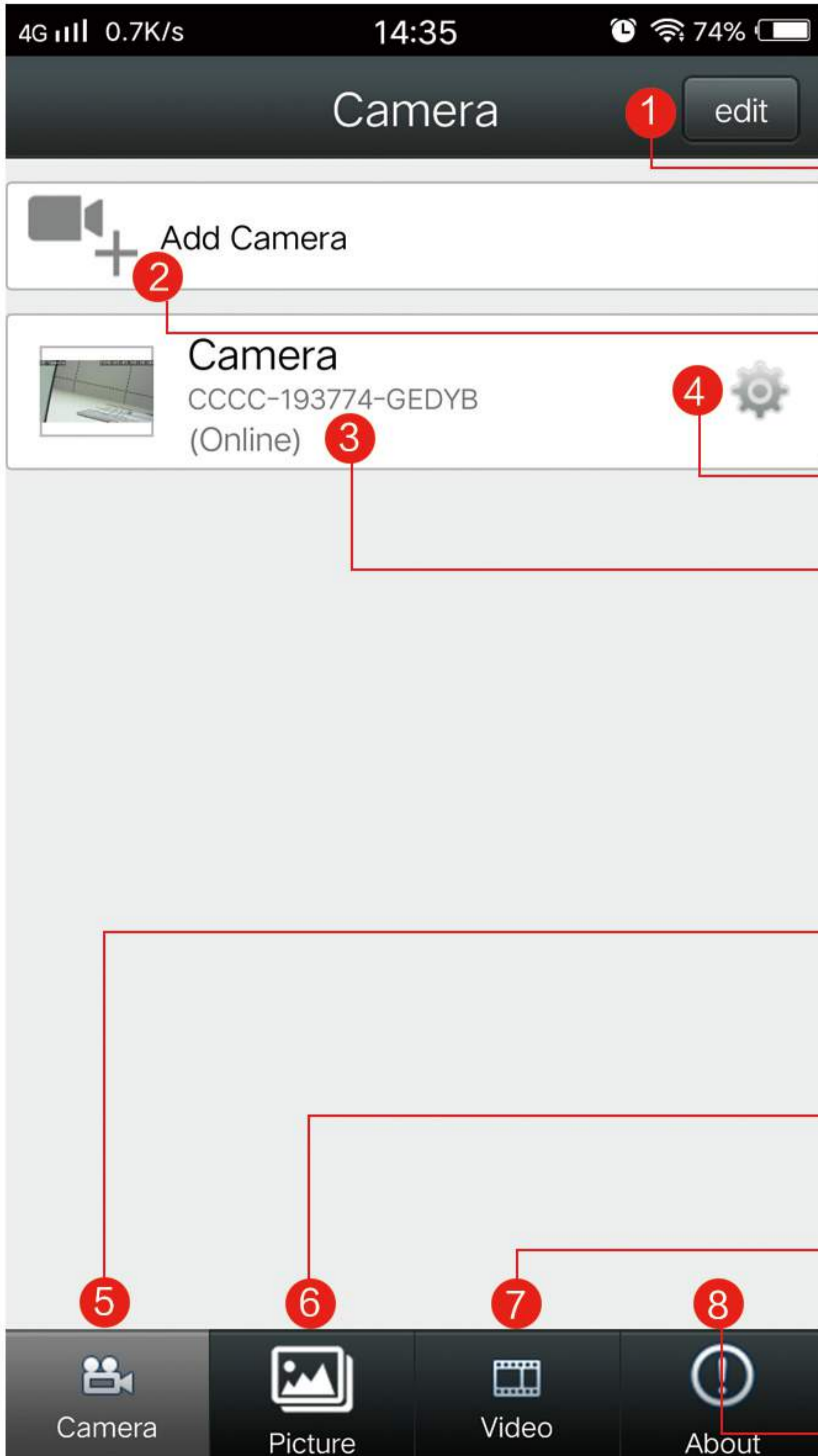

Be able to edit the name of the camera and the user name information.

Click to add camera, up to 50 units can be added.

Parameters setting

The state of the camera: online, connecting, Disconnected, the user name wrong, Wrong password, or invalid UID.

Main interface, click here can back to the main interface of the APP.

Check the snapping pictures saved to phone.

Video view. There are local video and remote video.

APP version information checking.

(picture 7-1)

7-2.Video graphic interface description



(picture 7-2)

① Horizontal or vertical flip for the monitor screen.



② Here can set the zoom in/zoom out/focus in/focus out.

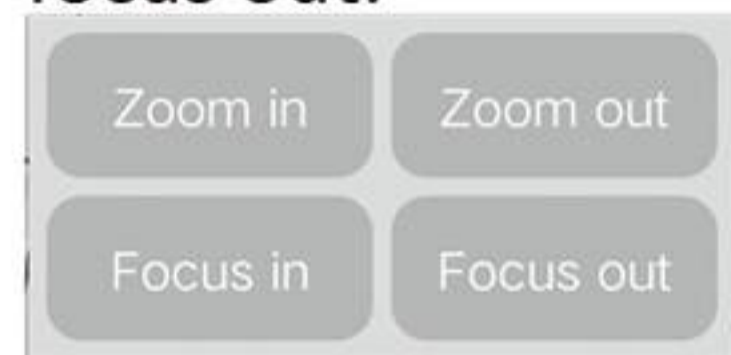

③ Preset setting

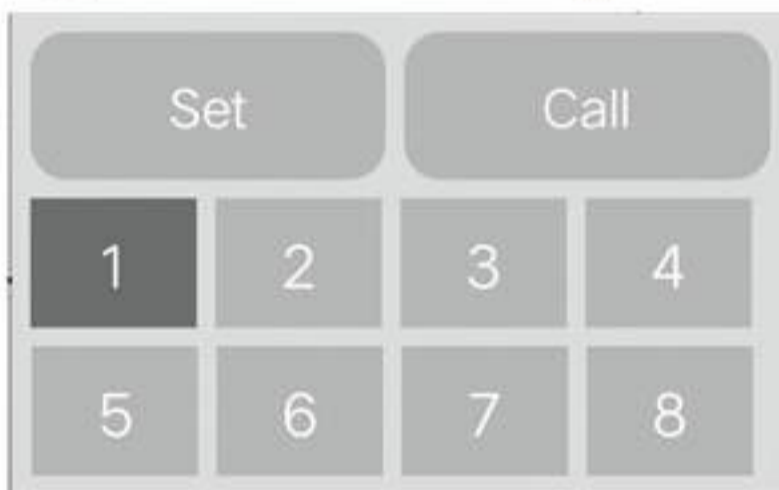

Phone can make 8 preset points.
After setting, Please call it to test.

④ Exit the monitoring screen.

⑤ Voice monitor

Speaker mute Voice monitoring Hold to talkback

Warm prompt: Default is speaker mute, need to click the icon of trumpet to open voice monitoring. And this function can just be made as the camera followed the sound pickup and microphone.

⑥ picture capture

⑦ Local Recording

Click this icon, it will turn into red color, and the screen will come to "REC..".
The videos will save to the phone as a videos file which name is "videoRecoding".

⑧ image quality optional

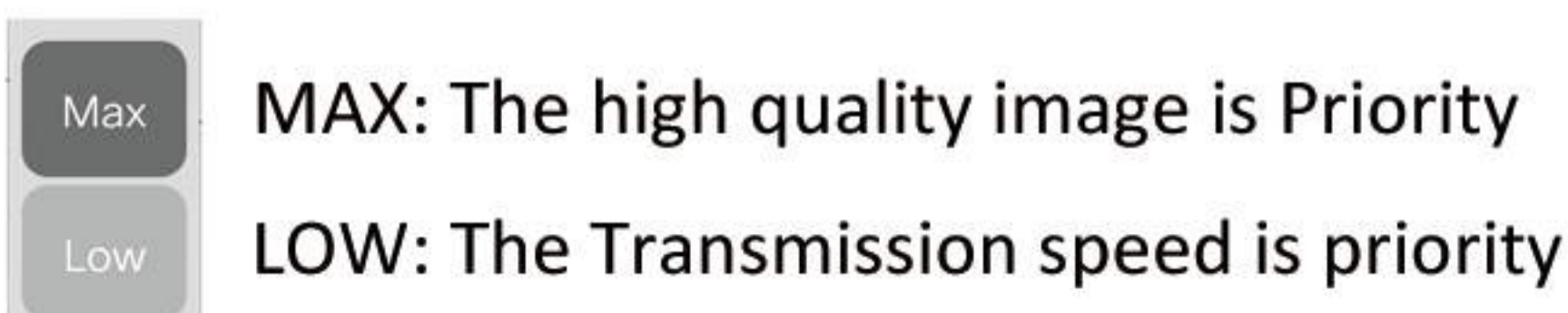

7-3.Photo check

In the APP main interface, click "picture" and click the device(UID) which you want to check (as shown in figure 7-3), the Snapshots will be shown(as shown in figure 7-4). Local Snapshots saved separately in different ID, click the image will come out delete optional, then click delete and "yes" can remove the pictures(The snapshots are saved into their corresponding album).

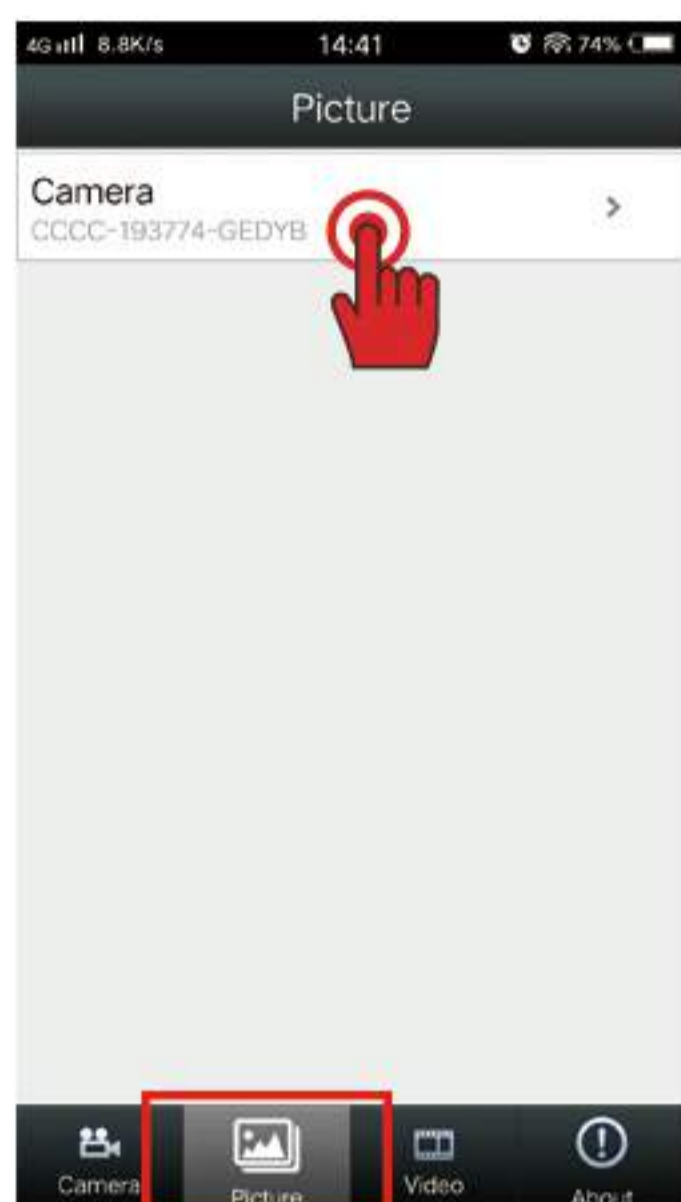

(picture 7-3)



(picture 7-4)

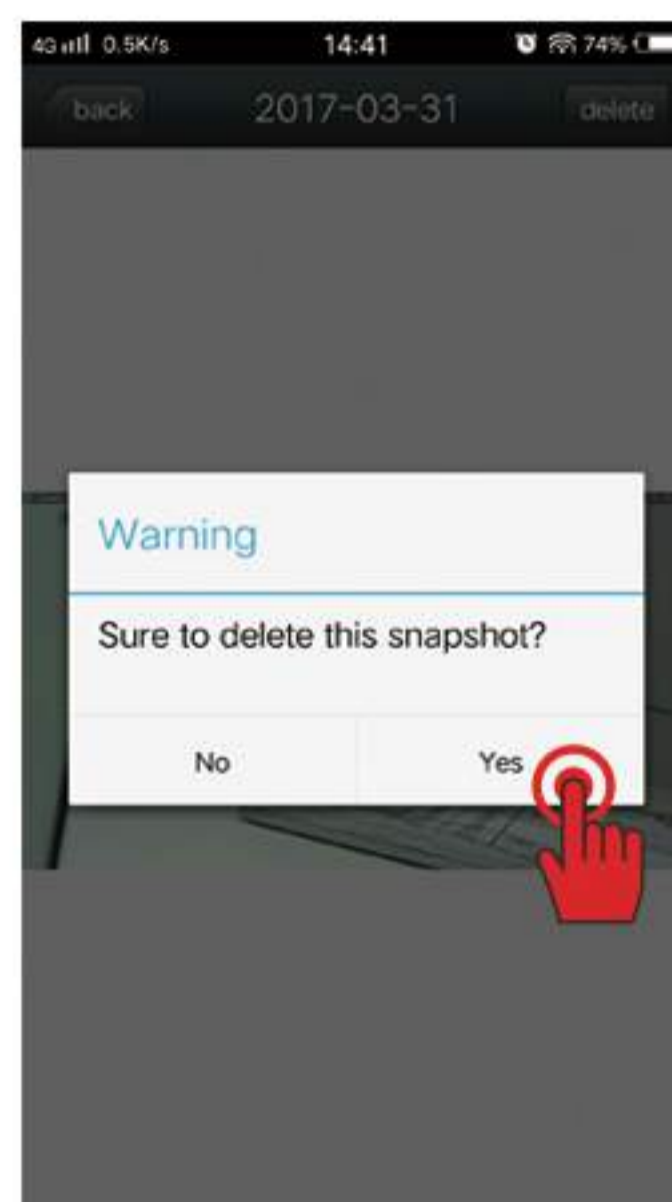

(picture 7-5)

7-4. Video Viewing

In the APP main interface, click "Video" into "Video viewing", there are "local" and "online" videos(As picture 7-6). "Local" means the videos are stored to the phone, "online" means the videos are stored to the Build-in SD card. Before you view video, please choose the right storage path. If you want to view the data of few days ago, choose "search" to find it(As picture 7-8).

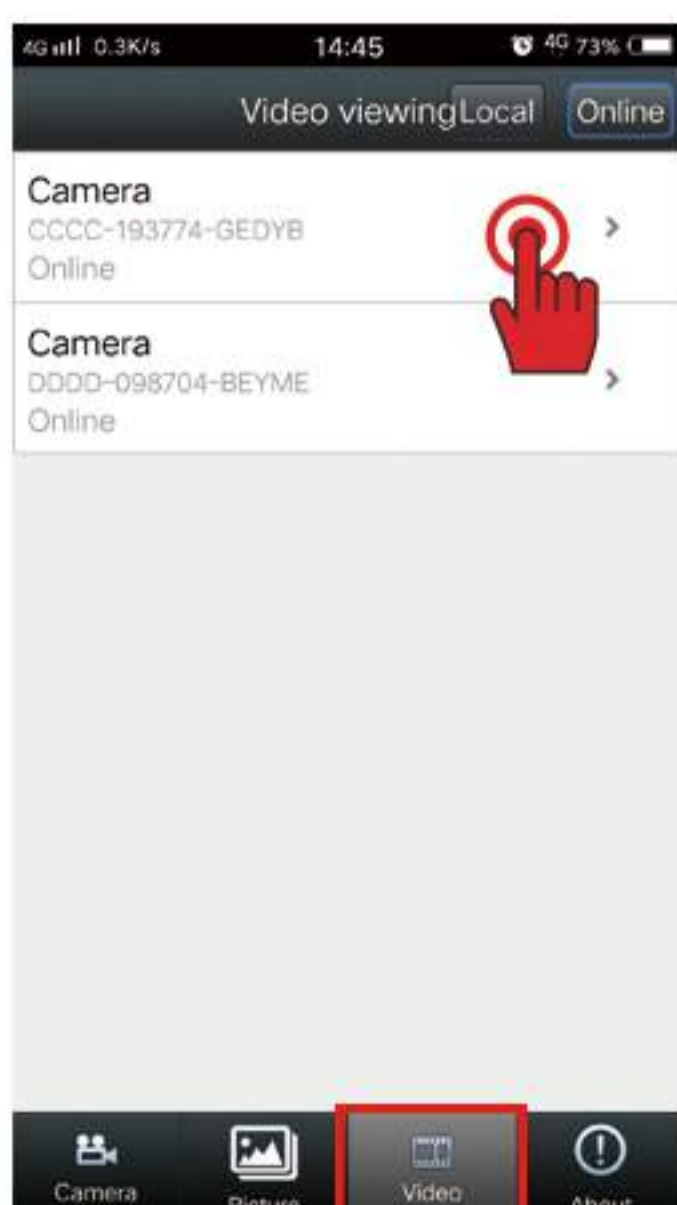

(picture 7-6)



(picture 7-7)

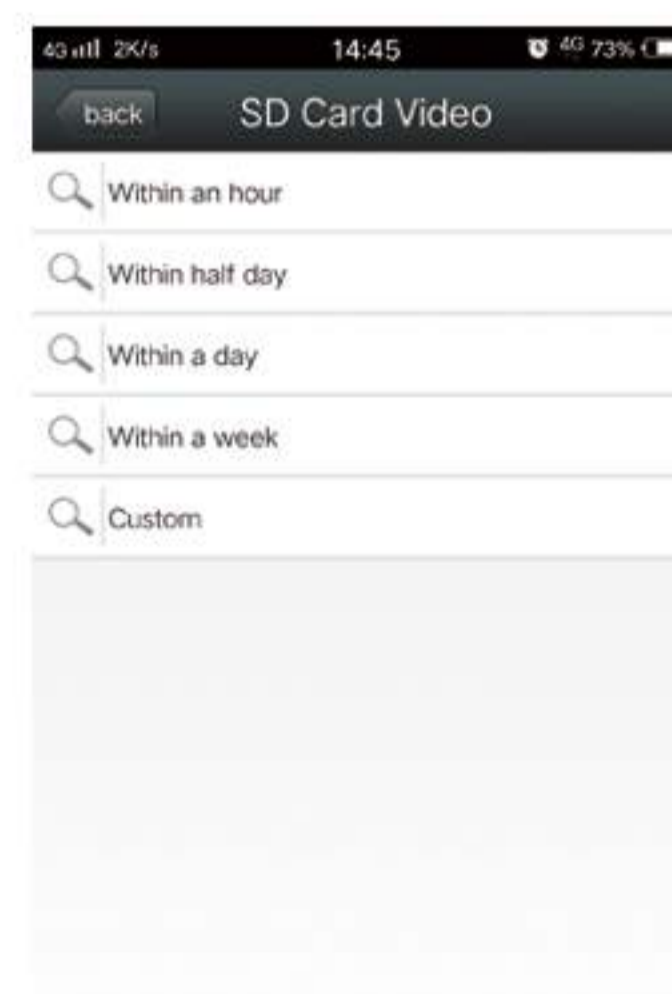

(picture 7-8)

8.Parameters Settings

Please refer to page 6 figure 7-1 to enter into the parameters interface

8-1. Edit Password

Edit password: can change the view password of each camera.

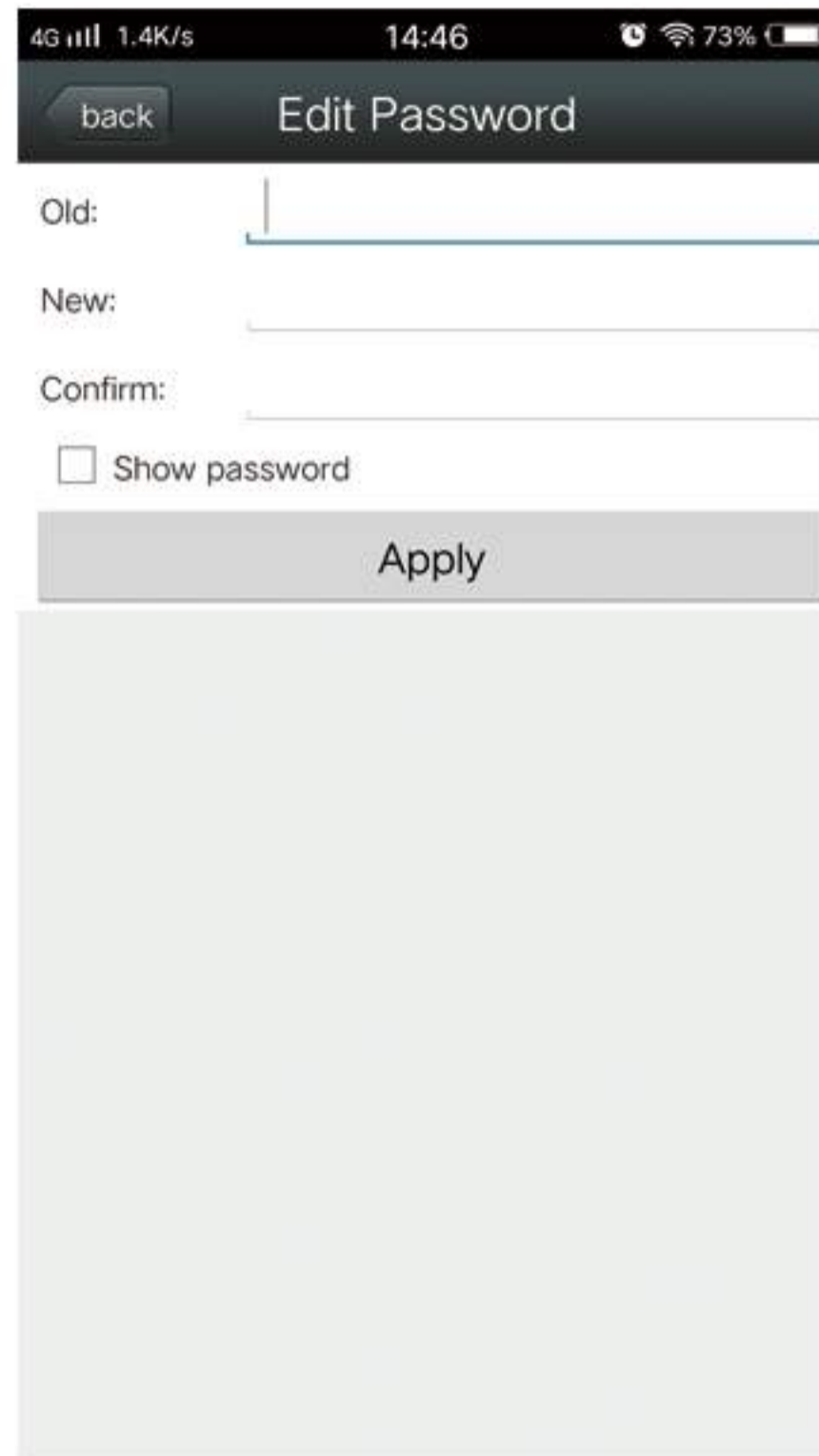

8-2. Alarm Setting

Motion Detection: ON/OFF optional

Level: the level of the motion detecting sensitivity, High/Normal/Low optional

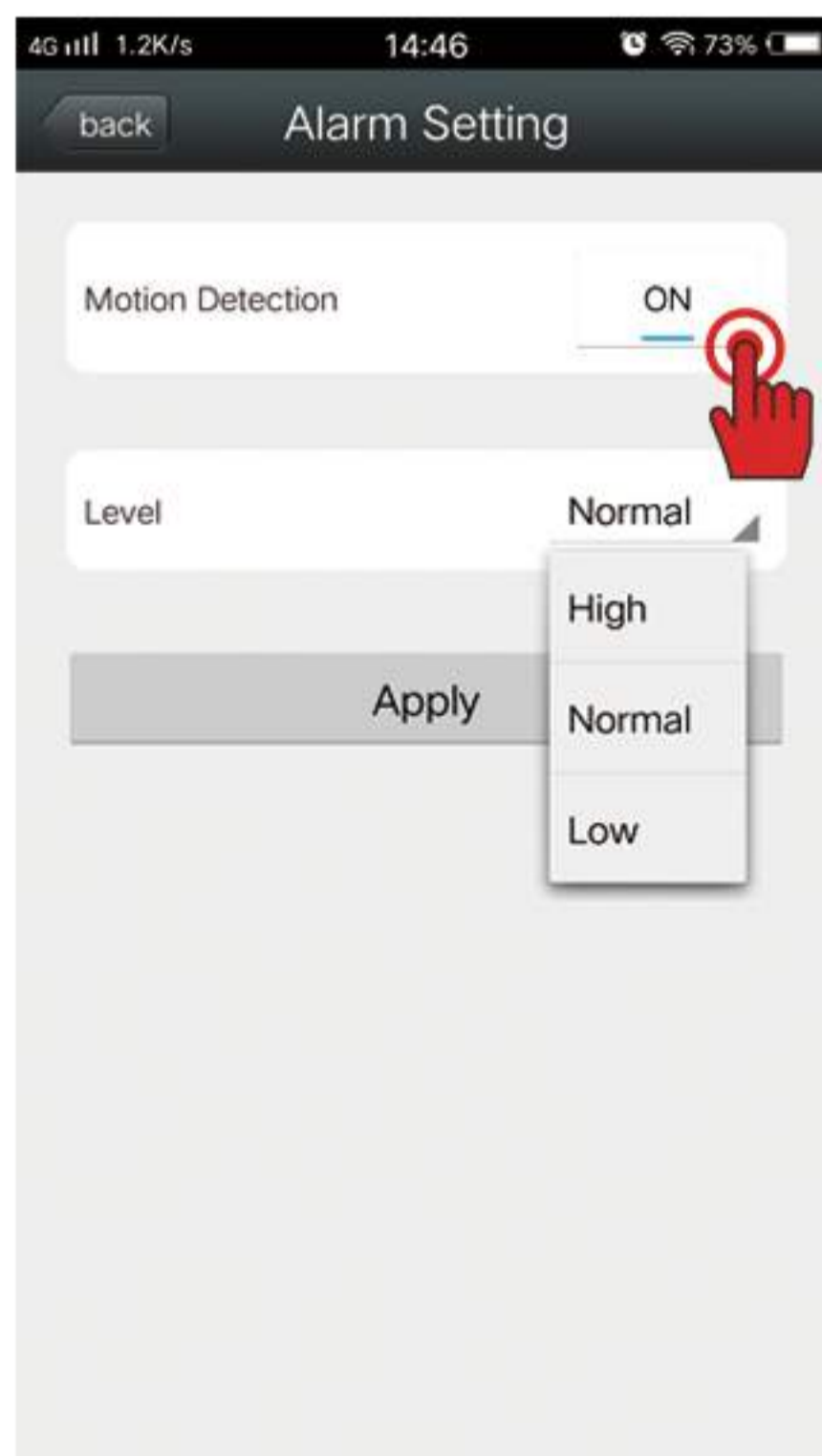

8-3. Action with Alarm

Alarm Notifications

“ON” means the alarm will come a push Notification

Alarm SD REC

“ON” means the Alarm Recoding will storage to SD card.

E-mail Alarm With pictures

“ON” means the Alarm snapshots will send to the assigned Email.

Save pictures to FTP server

“ON” means save the alarm snapshots to the assigned FTP server.

Save videos to FTP server

“ON” means save videos to the assigned FTP server.

Picture Num

The quantity of snapshots you want to catch. 1-3pcs optional.

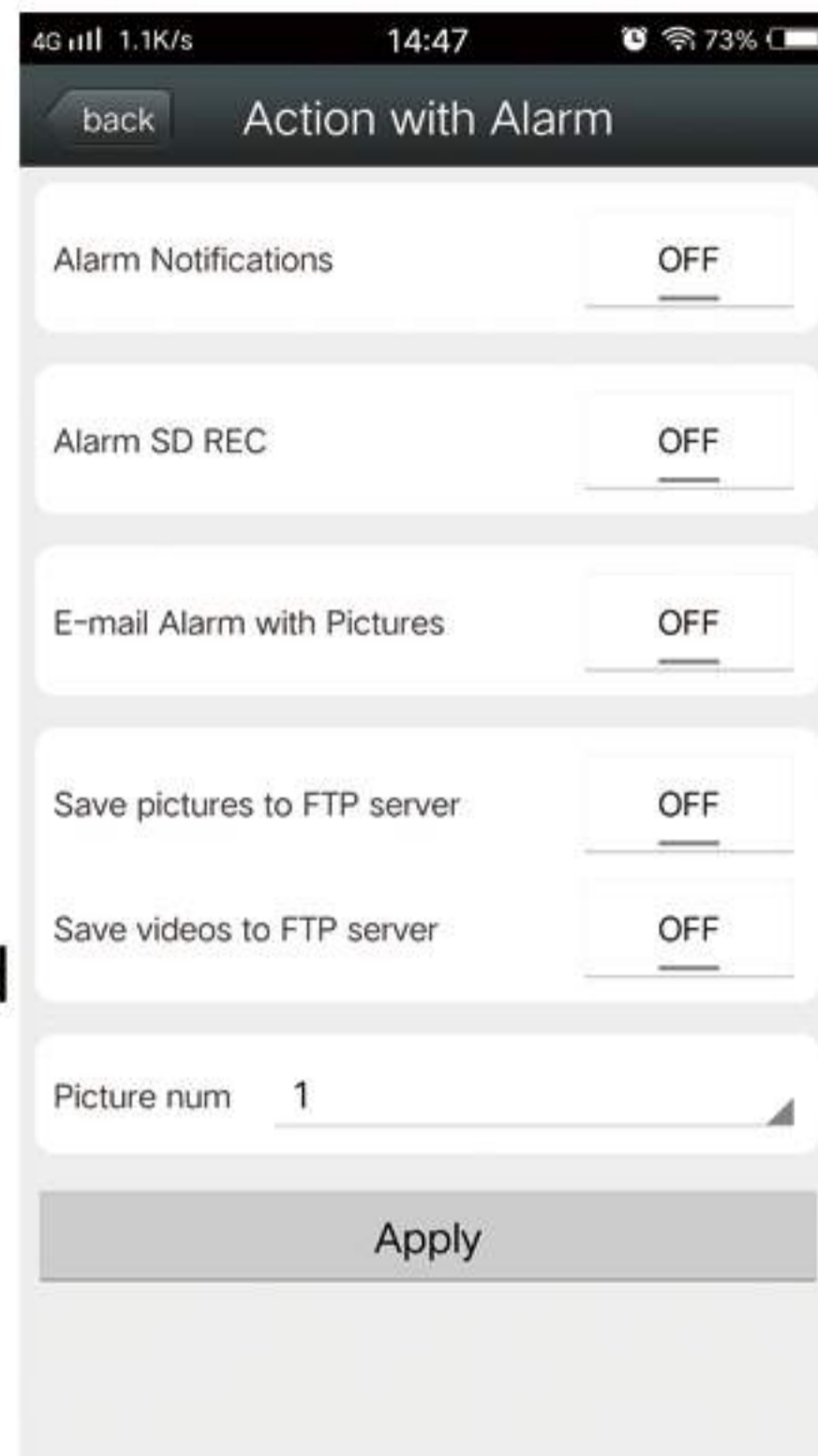

8-4. Timing Record

Record files duration: The time range of 15-900 seconds, default is 600s.

Enable Record: ON/OFF, Default is ON.

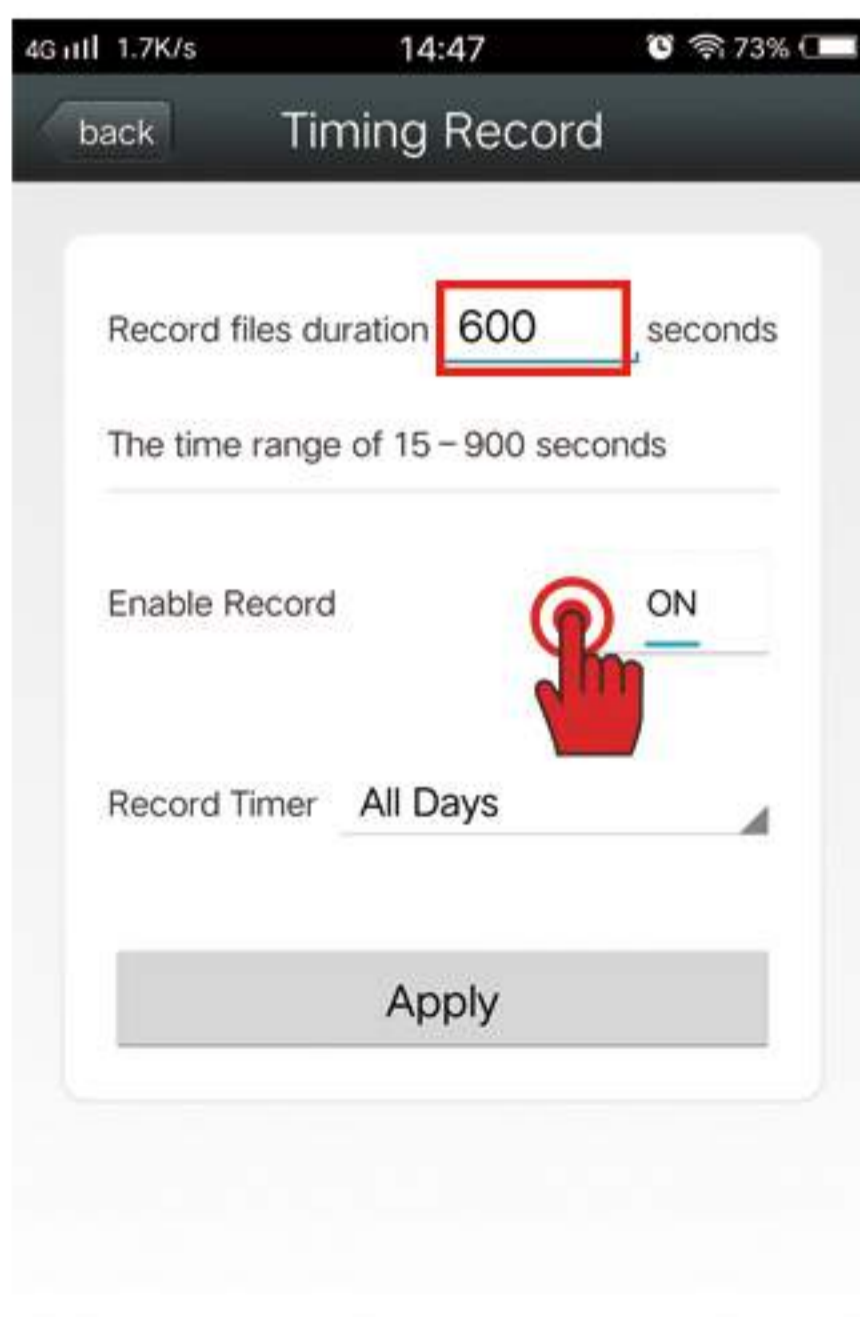

8-5. Audio Setting

Input Type: Line in/ Micphone optional.

Input Volume:0-100 optional.

Output Volume:0-100 optional.

Remark: Just Audio(with pick-up and speaker) camera need this feature setting.

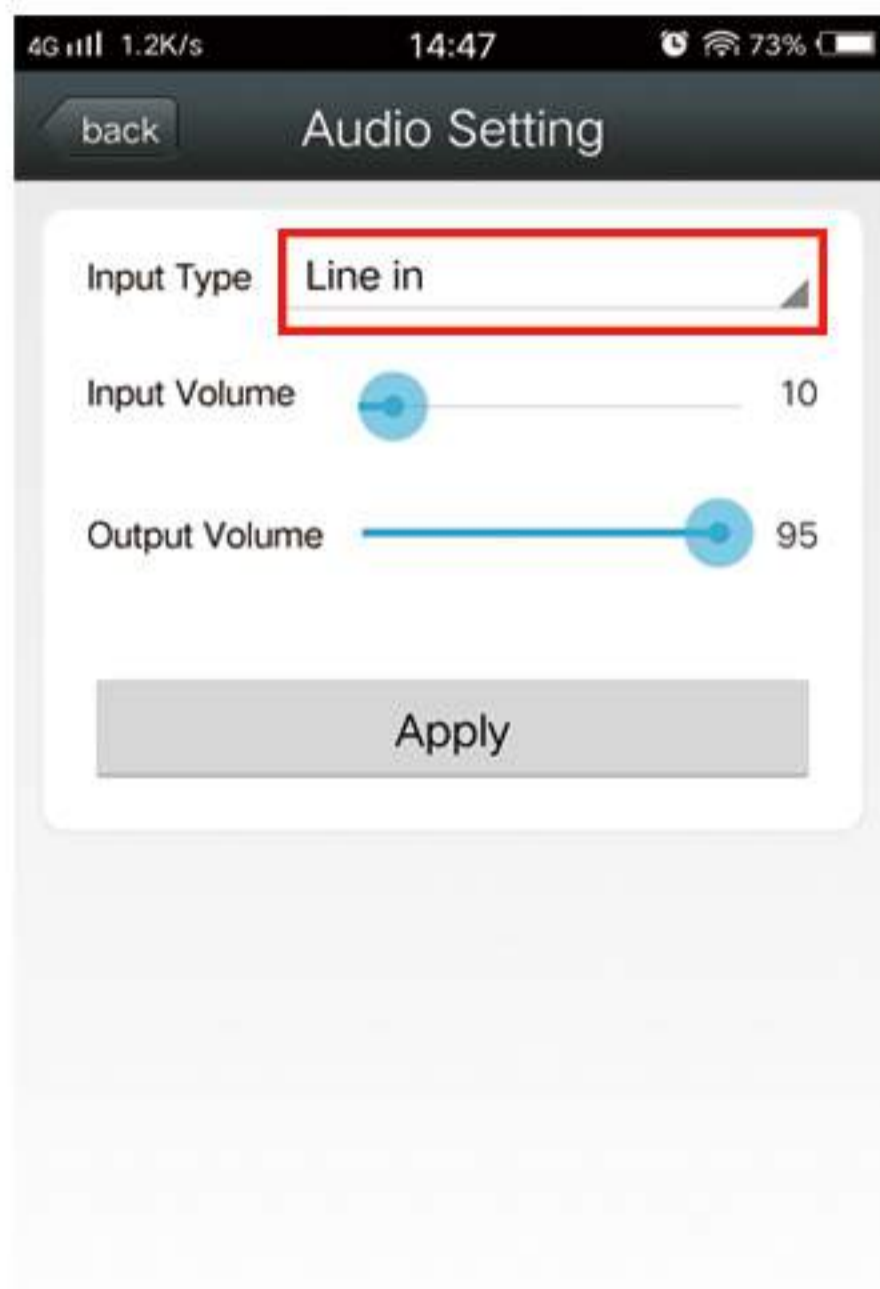

8-6. Video setting

First Stream

Bit rate: The bit rate of first and second stream can be customized. Range is 32kbps~6144kbps.

Frame rate: The Frame rate of first and second stream can be customized, Range is 1fps~25fps.

Image quality: The smaller value, the better image quality, larger flow control. 1-6 optional.

Video format: 50HZ/60HZ Optional.

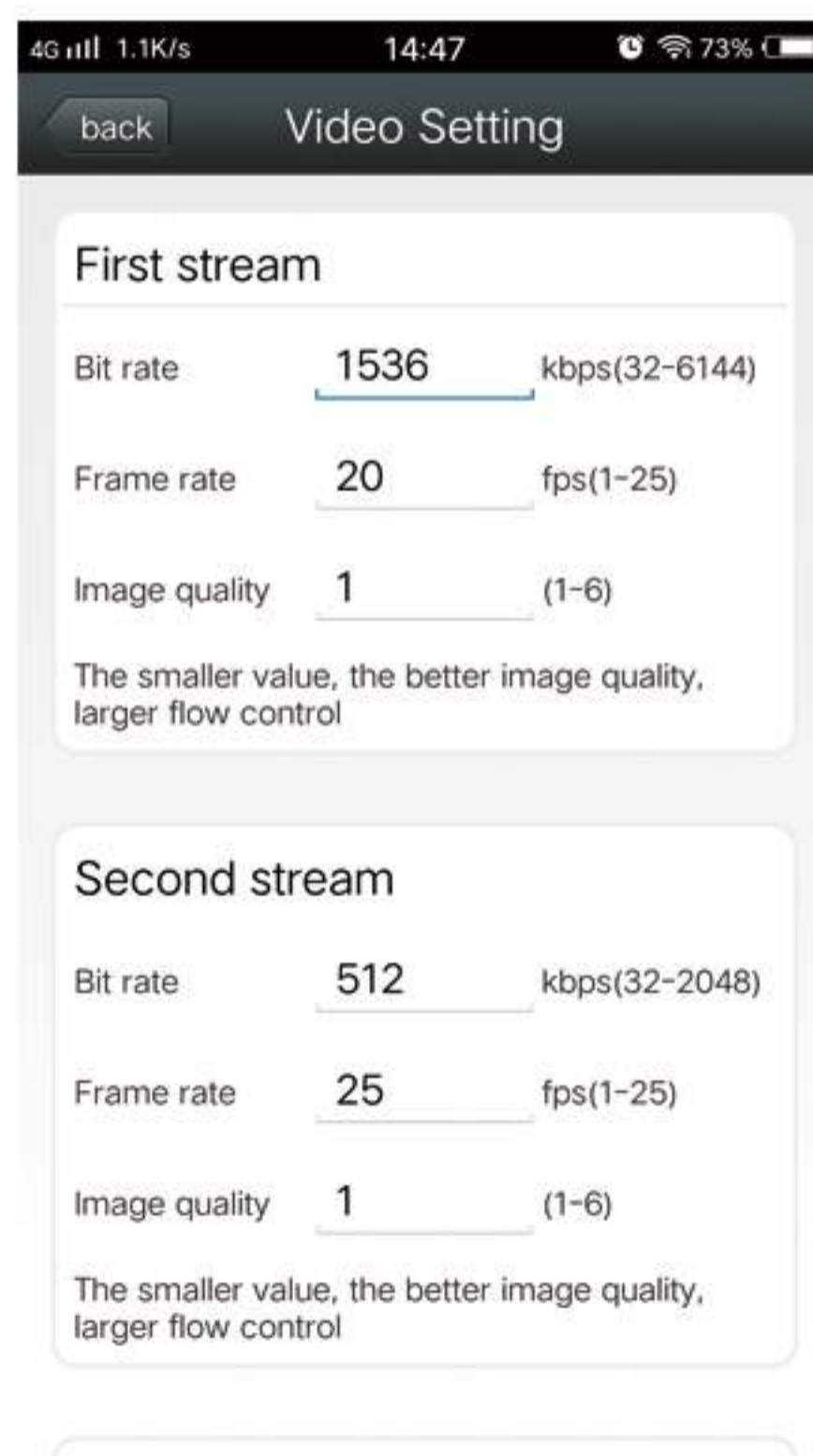

8-7. SD Card setting

Can obtain the total space and the available space of the SD card, and SD card format.

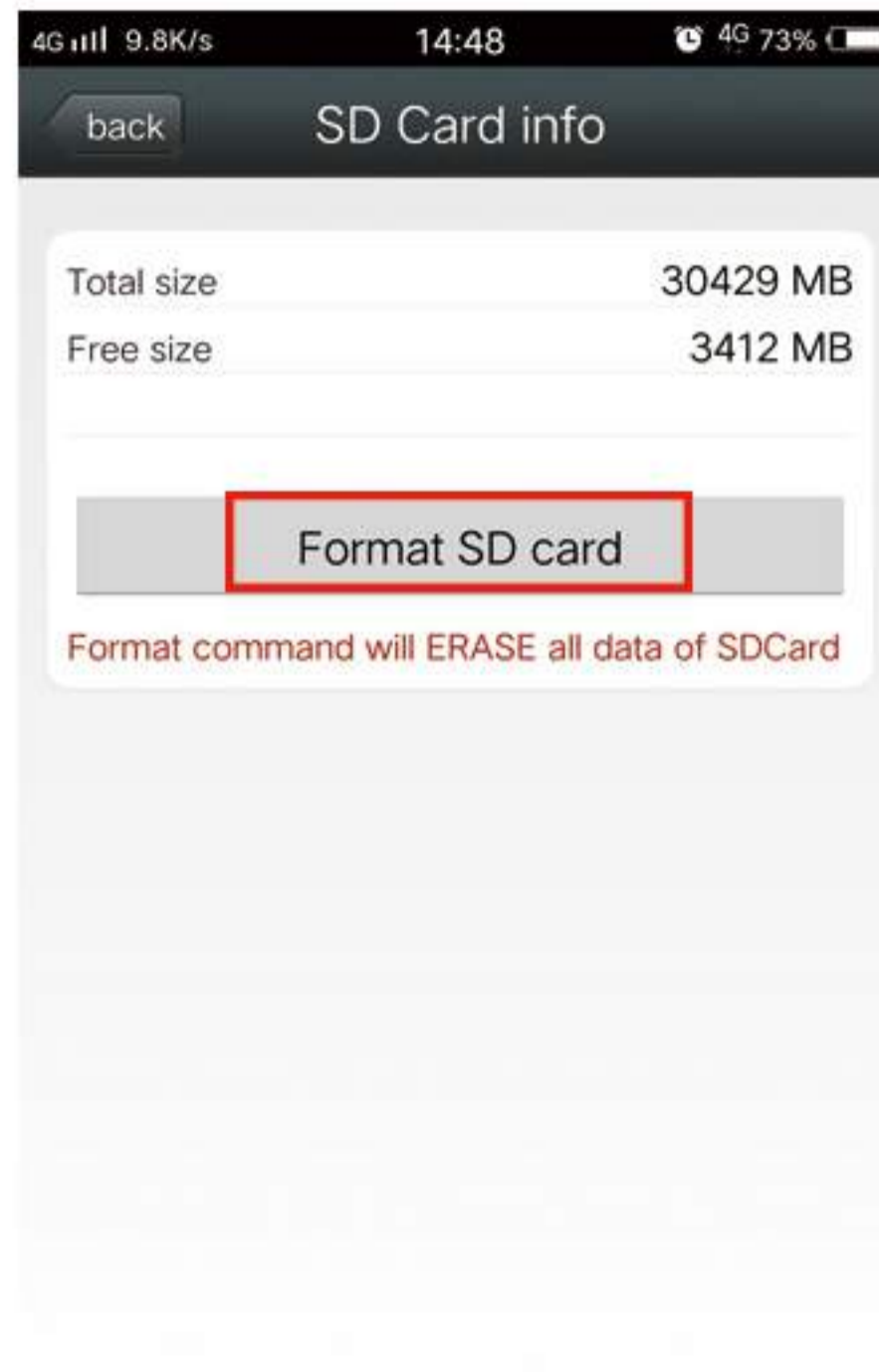

8-8. Time Setting

Enable Synchronize device time with phone time.
After time Zone Setting successful, the device will restart.

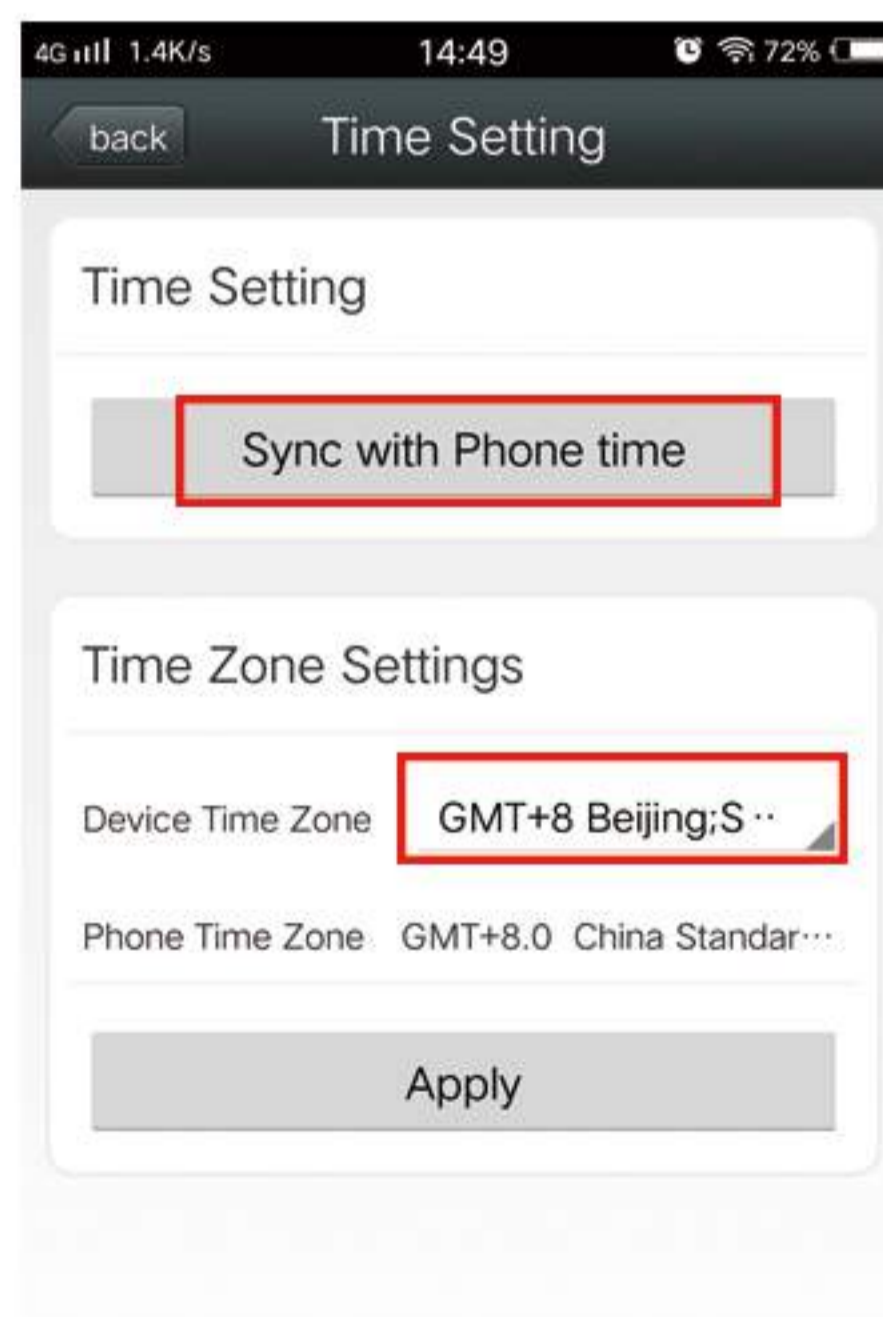

8-9. Email Setting

Take QQ email for example as follow:

SMTP Server: smtp.qq.com

server Port:465

Encrypt Type: SSL

Username: fill the blank with your email address

password: the password of your email address

Sent To: fill this blank with the email address to receive the alarm snapshots.

Sender: Fill this blank with the Email address which send the pictures.

Warm Prompt: All the email "username", "Send to", "Sender" can be the same Email Address. Please ensure the server of IMAP/SMTP&POP/SMTP is ON.

Subject and Message: anything content is ok.

After completed, click "Test" to check the Email setting, if it is successful, click "Apply".

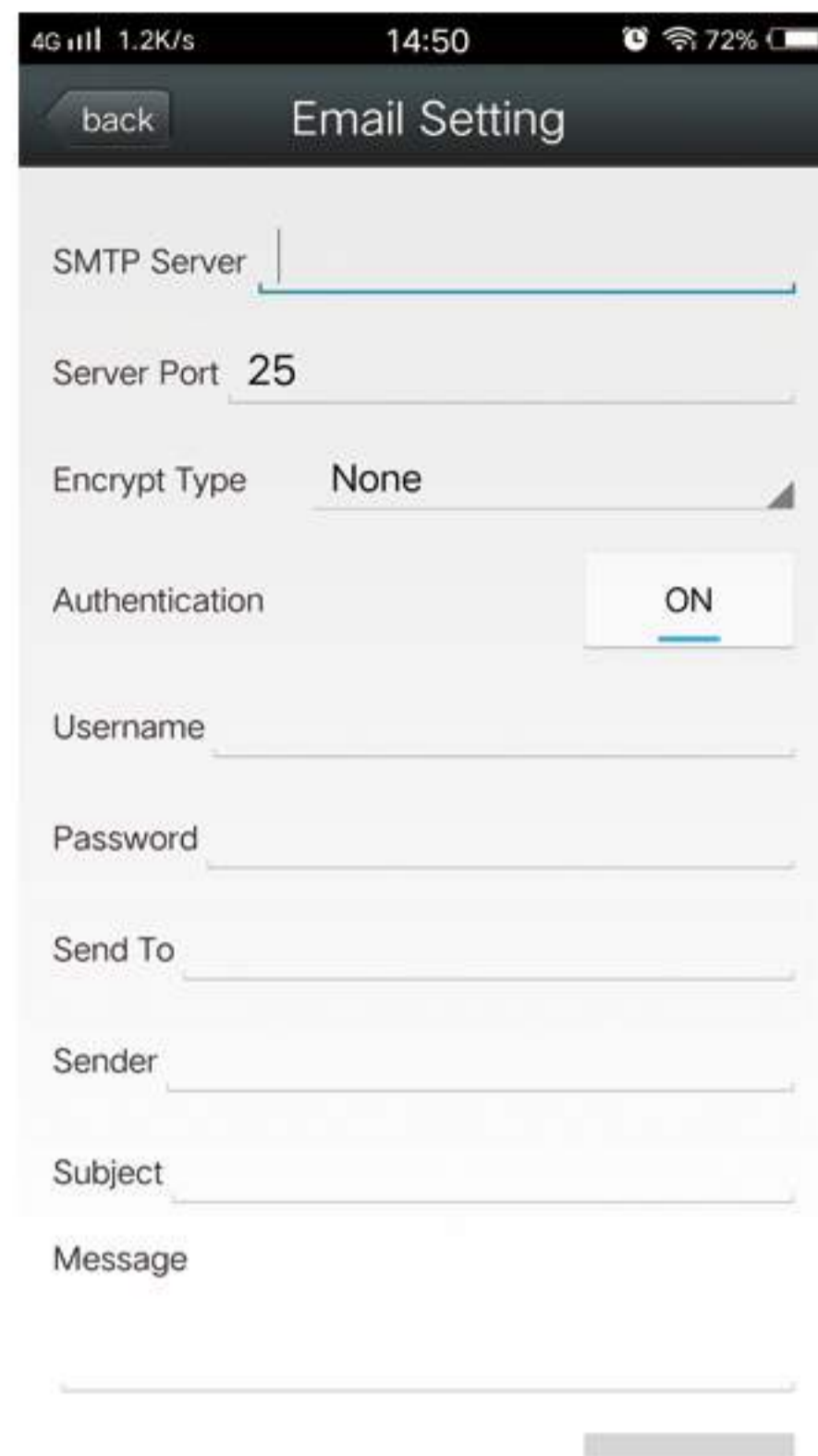

8-10. FTP Setting

Server Address: Fill in the blank with the FTP address.

Server Port: Fill in the blank with the FTP port.

User Name: Fill the blank with the username of the FTP server.

Password: Fill the blank with the password of the FTP

After completed, Please click "Test" to check it is successful work. Remark: This function setting is needed in the situation that FTP server already be set up.



8-11. System Setting

Here can restart and reset the camera, after reset the camera, all the setting will back to the default situation and the wifi need to reconfigure.

(To ensure the camera normal use, Don't reset camera casually)

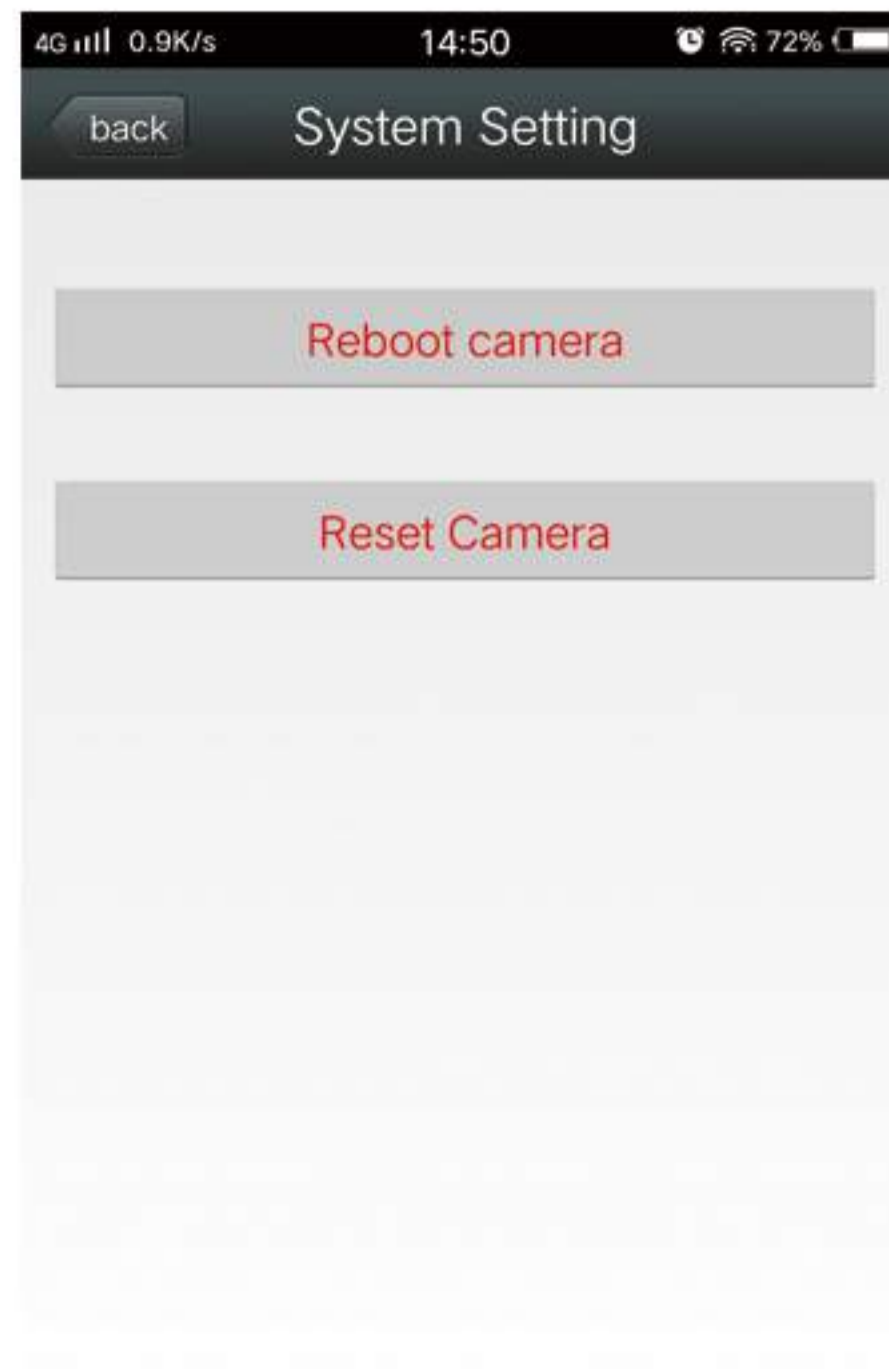

8-12. Device Information

Device information: including network status, user number, IP address, subnet mask, gateway, DNS, etc.



PC App Instructions

1. Connection Diagram

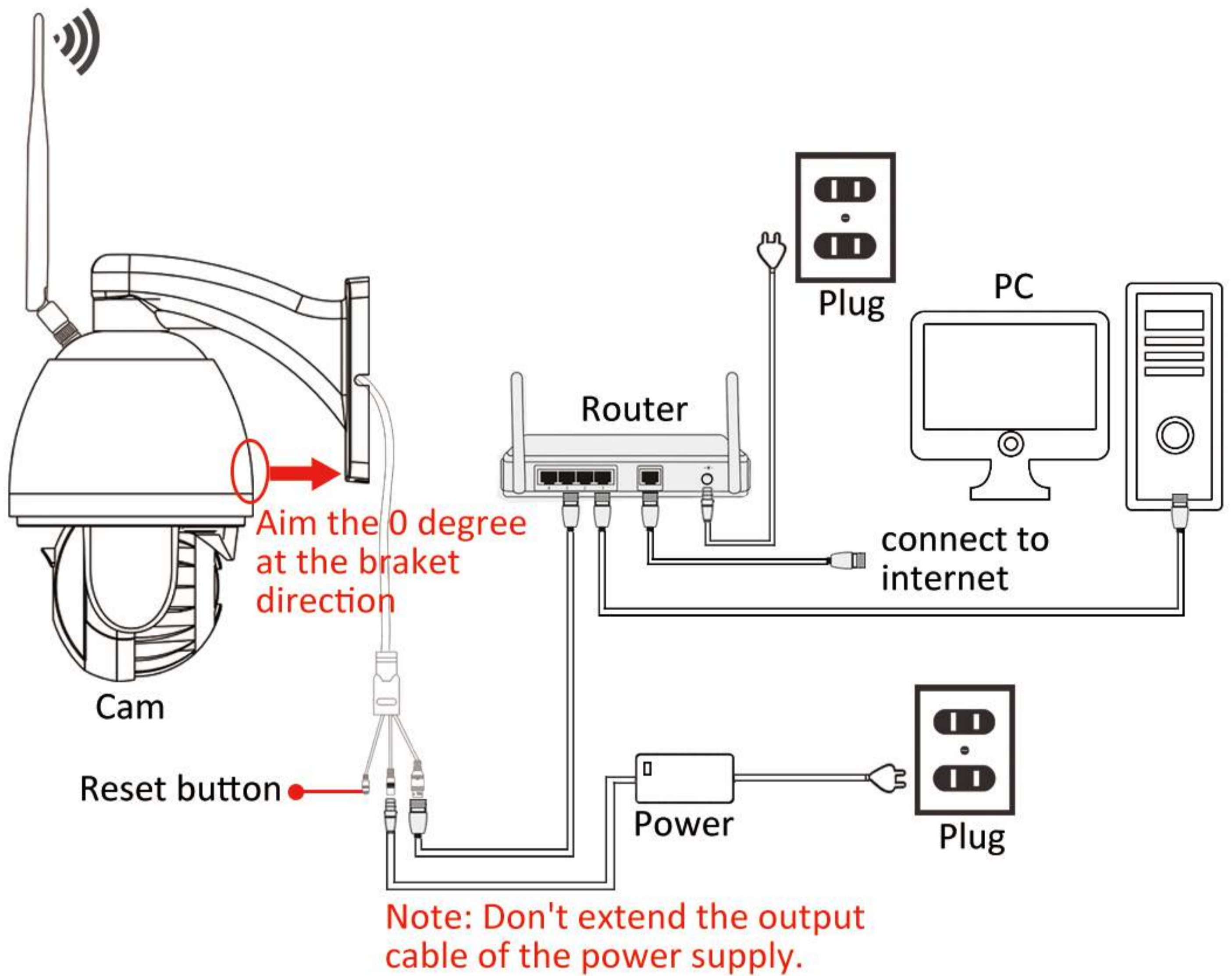

2. PC App Download and installation

Open the attached CD on computer and download software or contact customer service for relevant software.

3. PC App Details

3-1. Login and Introductions

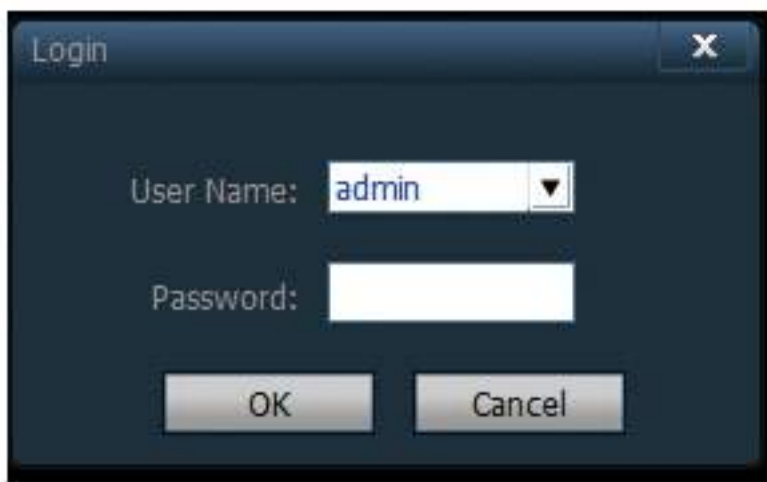

【Login in】 Click the PC App, the windows come to the interface of login in, Default User Name “admin” ,password is empty, click "OK" enter into the client main interface.

Exit: Only the users with admin permissions can exit from CMS, user and guest can not exit from CMS. When exit from CMS, you need to input the authorized user name and password.



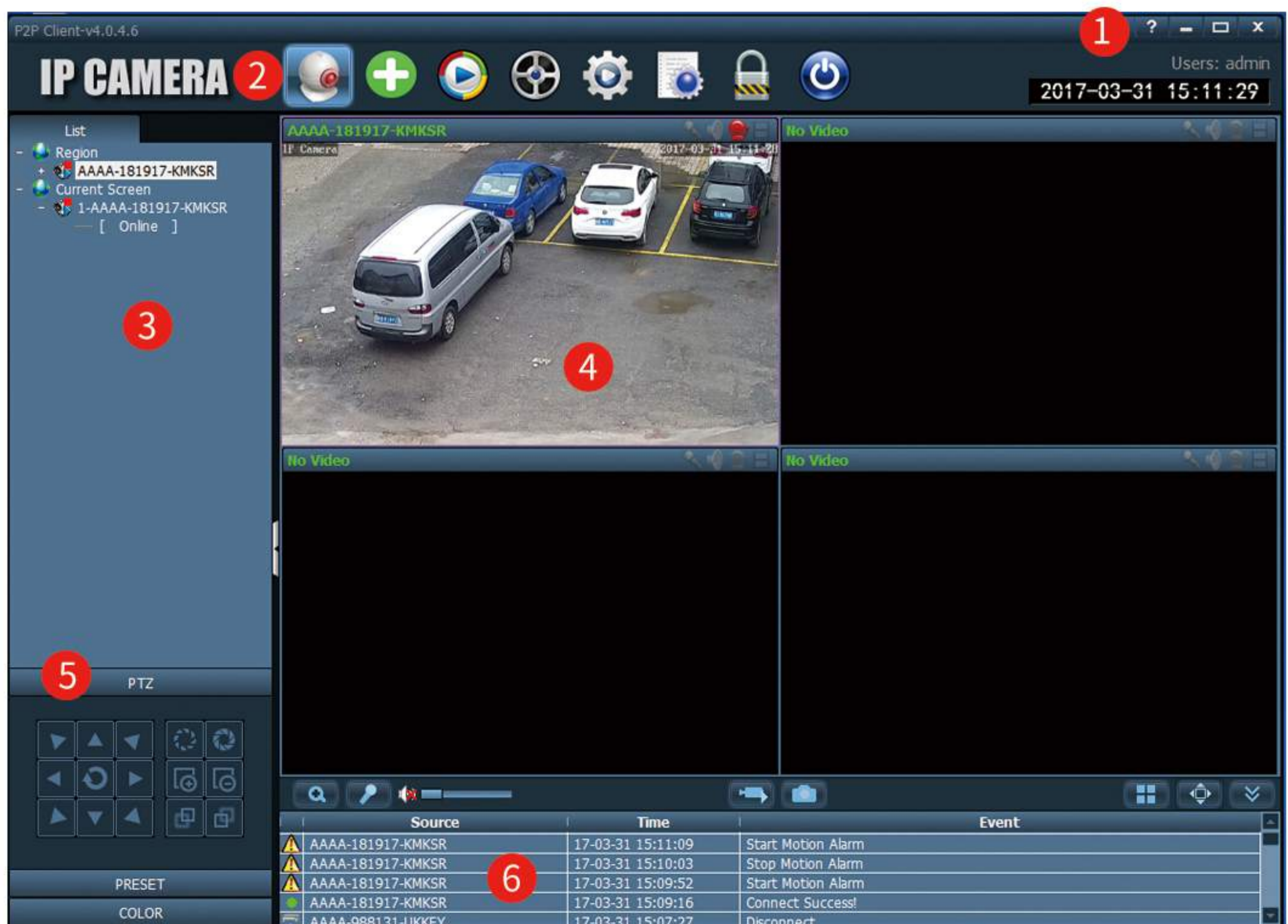

3-2. Instructions of interface





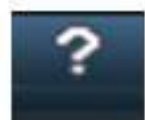





The software interface as shown in above, mainly divided to 6 sections:

- 1 System button bar
- 2 tab bar
- 3 device list
- 4 realtime preview
- 5 PTZ control
- 6 Alarm info list

System Button List

-  Help button, Click it to open CMS instruction
-  Hidden button, Click it to make the window hide into system tray
-  Maximize button, Click it the CMS window will cover full screen
-  Exit Button, Click it will pop up Exit Reminder

Tab bar

-  Click it to preview the videos.
-  Automatically add the cameras(All the cameras will be added which share the same router)
-  Click it to replay the recording videos.
-  Click it to remote playback interface.
-  Click it to Setting interface
-  Click it to Logs operation
-  logout &Switch User
-  Exit App

Device List





【Region】

According to user configuration to show area, setting ,and channel.

【Current Screen】

Display the connected device.

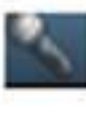
Real-Time preview

-  Digital Zoom button, Click it then choose the screen area you want to magnify.
-  talk button. choose the device you want to talk, then click this button, As the window status bar come to  , the talk function is made succesfull .(only one device can be made talk at the same time).
-  Audio monitoring button, click it will open the audio function, As the window status bar come a  ,the audio is made successful. Click it again to close it. multiple devices can be monitored at the same time.



Record button, choose the video you want to record, then click this button, as the window status bar come a , the recording is beginning. click the button again will close recording.



Capture button, choose the image you want to capture, then click this button, the snapshots will be made. 2 photos can captured at 1 second at most.



Button of Multi-image screen, click it to choose multi-image display, 1,4,6,8,9,16 image optional.



Full screen button, click it to display the real-time preview area full screen.



The List roll of Alarm information ,Click it to show the alarm information and hidden it.

3-3.Device management

Before using the CMS, you need to add device and make configuration. Click , enter into device management interface.

【Region List】 When software run initially, default Region list is empty. Click “add area” button, pop-up “add area” dialog box. After filling area name, click “ok”, a subsidiary area will be made.

Note: up to 128 areas can be added at present.



Add area into device tree

Modify the name of selected area

Delete the selected area

Add device manually by UID number.

Edit device

Delete selected Device

Add the searched devices to selected area

Click it to search the devices in LAN

Select all searched devices.



Add devices

I. Add device in LAN

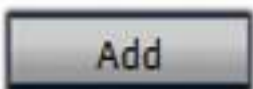
Click “Search”, all the devices in LAN will come out, then tick the device needed to add from this search list, and choose the area you want to add to, click “” to add the device successful.

II. One-Click to Add devices

Click “” button, all the device in the same LAN will be automatically added and connected.



III. Add devices manually

Click “” will pop-up below dialog box:

Add Device

UID:

Name:

User Name:

Password:

Area:

UID: device UID number, every camera own a unique UID number.

Name: The name of the device, can be customized. Device name can enter 15 characters at most.(Note: After input a name, the name will instead of UID number to display in the main device region list.)

User Name: the user name of the device, default is “admin”.

Password: The password of the device, default is “admin”

Area: The area of device belonged to, choose the area you want to add device, then click “OK” .





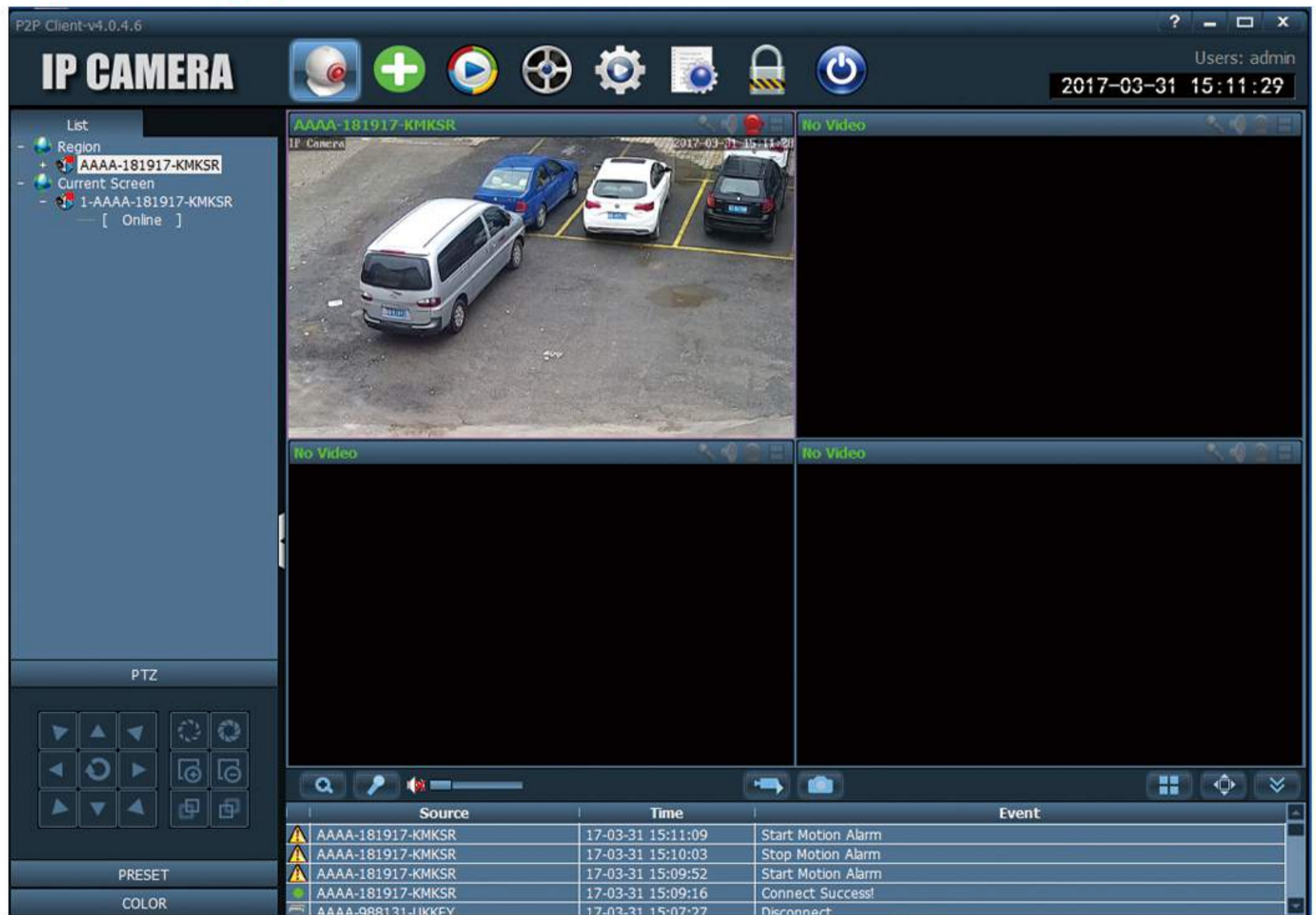

3-4. Image & videos Preview



After devices configuration, click the "preview" in the TAB bar, return to main interface, the device tree default in the form of list tree, click the "group" and "list" can switch group and list information. The default screen display is 4 image segmentation, can max up to 36 images segmentation, and 16/25/36 images optional, the more pictures, the host is corresponding to upgrade, If use 25 or 36 images, it is recommended to use more than i3 CPU with independent video card.

Warm prompt: if display black screen and the picture failed show, try to upgrade the graphics card driver.

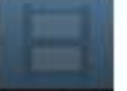
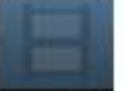

Display image Instruction:

- No Video** It indicates this channel haven't connected any device. If connected, OSD information will be displayed.
-  talk button, when the icon becomes , it means the talk function is on. Otherwise it is off.
-  Voice monitoring, when this icon becomes , it means the voice monitoring is beginning, otherwise already stopped.
-  videos status. When this icon becomes , it means the videos is manually recording,  otherwise means this channel is recording as configuration.

Double-click the device name in list mode, or drag the UID on the window to display images. If connect successful , there is a blue triangle  show behind the UID or device name, if status as  , it means the device is not connected. If the device is showing  , means channel is video recording.

Right-click any area, it will pop-up the picture as shown below:

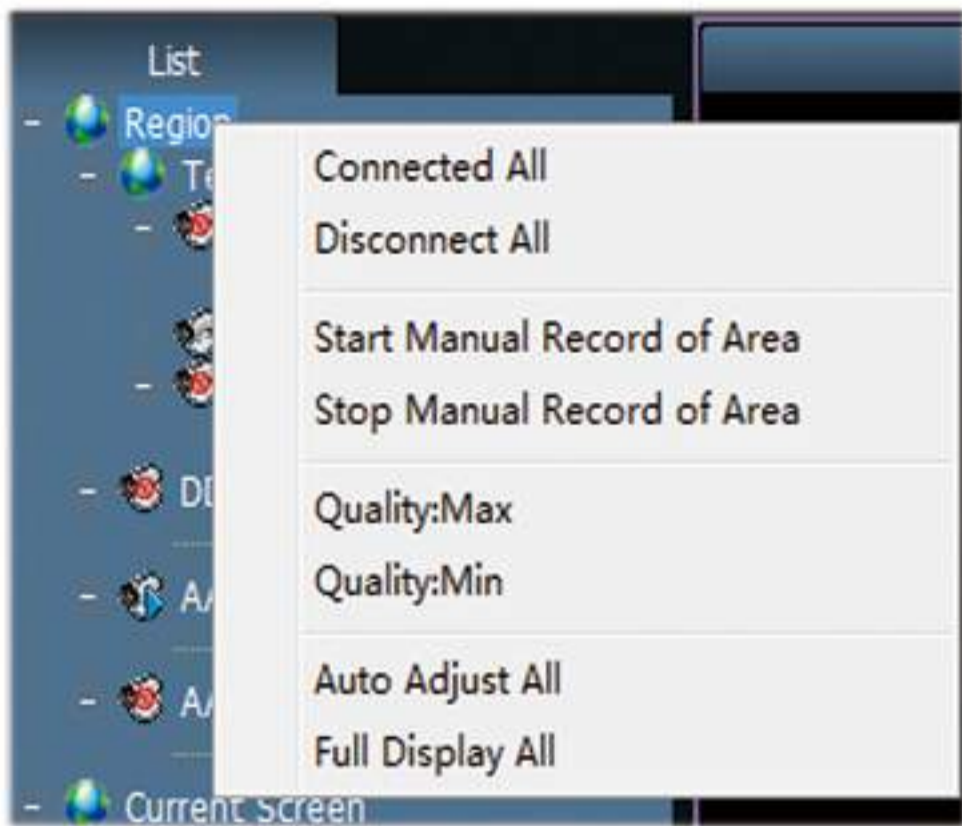

- [connected ALL] Connect devices in selected area
- [Disconnect All] Disconnect the devices in selected area
- [start manual record of area] Open manual record in selected area
- [stop manual record of area] stop manual record in selected area

[Quality] Max、 Middle and Min optional. according the internet environment to choose the suitable image quality.

[Auto adjust all] Adjust image display ratio automatically in select area

[Full display all] the device images display in select area as the size of segmentation picture.

Note: the device is still in the connection state after close the screen image display, and the videos recording keep same as before configuration.

3-5.PTZ control

3-5-1. PTZ Control

You can control PTZ rotation to eight different directions by direction key.



-  Iris enlarge button
-  Zoom in button
-  Focus in button
-  Iris shrink button.
-  Zoom out button
-  Focus in button

Note: Above function can just be made as the lens of camera support

3-5-2.Preset Setting

The CMS can support Max to 128 preset points.

[Preset setting] Choose the device that need to set preset, then select preset number, click “set” button, preset point set successfully.

[Goto preset] Choose the window that need to call preset, then select the preset number, click “Goto” button, before “goto” you must set preset firstly.

[delete preset]Choose the window that need to delete preset, then select the preset, click “delete” button, thus preset deleted successfully.



PRESET	
NO.	PresetName
001	Preset001
002	Preset002
003	Preset003
004	Preset004
005	Preset005
006	Preset006
007	Preset007

Buttons: Goto, Set, Del

①Preset Patrols

Preset point 1, point 2....point 8, then “Goto” preset number 65 to start the patrol.(patrol require 2 preset points at least)

② The setting of two points patrol

First preset point is 92, second is 93, then call the preset point 87 to start slow-speed patrol, call the preset point 88 to start the medium-speed patrol, and call the preset point 89 to launch the rapid scanning.

③ preset point back to number 1 after power outage.

Serial Preset number 1,66,68 in order can make the preset back to number 1 after power outage.

④ back to preset patrol after power outage.

After the patrol set successful, then continue preset 66,and preset 69. “goto” 65 to start the patrol.Above setting will make the preset back to the patrol after power outage.

⑤two point patrol after power outage.

After set two point patrol, then continue preset 66, preset 70, “Goto” preset 87 to start the two point patrol.

3-6. Record Management

3-6-1. plan of record

In the tab bar to choose “setting”-- “record management”—“Enable the plan of record”, as shown in above:SUN – SAT means one week,based on the count of day ; 0 – 23 means one day, based on the unit of half an hour.



[Enable the plan of record] Choose channel, then click the left mouse to drag a green blocks in the schedule, as above shown; green area is the time bucket that enabled plan of record. After setting time bucket, click save.

[Close the plan of record] Cancel the tick in enable plan of record, click save; or cancel green block in schedule and click save.

The method of canceling green block: only need to click left mouse and drag mouse,the green block can be cancelled.

Note: If the “plan of record” time for all devices are the same, you only need to set one device, then click copy and save, then all devices enabled plan of record.



[General Record Length] The system default record length is 5 minutes for a single recording file. The file can set 1-30minutes(Please refer to the left picture).

[Maining disk begins recovery control]The scope is 1G-50G optional, when disk space is less than set range, it will skip to another disk or delete earliest record file(default recycling is 10GB).

[Record format] 264 and AVI record formats. If record format is 264, you must use manufacturer’s player to playback record.

[No hard disk space coverage] Select “Yes”, when all disk space is less than the set of disk space, it will delete the earliest record. Select “No”, when all space is less than the set of disk space , it will stop recording.



Disk	Total size(GB)	Available size...	Path
<input type="checkbox"/> C:\	80.000	56.370	C:\TRecord\
<input checked="" type="checkbox"/> D:\	20.000	16.849	D:\TRecord\
<input type="checkbox"/> E:\	11.784	8.145	E:\TRecord\

[Record path] After installed CMS, CMS will test the hard disk in device automatically, and display in the list, default to D disk.

3-6-2. Manual Record









Firstly select window, then click  button or right-click window to choose recording. Please check plan of record to see record length and path setting.

Note:

- 1.The CMS can support Max 24 drives, namely memory storage can connect Max 24 hard disk.
2. Display screen show , means the channel is in “ plan of record”, if show  means the channel is in “manual recording”.

3-7.Local playback

3-7-1.playback by time searching

-  “Play” button. when recording playback finished, click it continue to play.
-  “Stop” button. when play recording, click it to stop playing.
-  “Frame” button, when play recording, click it to single frame play, click one time, it play one frame image.
-  “Image capture” button, choose play window, click it to capture images to disk.
-  “Electronic zoom” button, click the button in the process of play recording , then draw the magnified image region in the window.
-  “Full screen” button, choose this button, the window area will display on full screen, if need to display a single window on full screen, double click the window.
-  When playback record, please select play speed through drop-down box, default is normal speed.
-  “Voice” button, you can choose open or close voice during playing record, default is closed.

[record playback retrieval]

Step 1: choose the Record file format and time

Step 2: select the windows that need to playback, and select channel in list tree.

Step 3: If there are files matched the condition in time scope ,it will display on timeline panel.

Step 4: double-click the device channel to playback record.

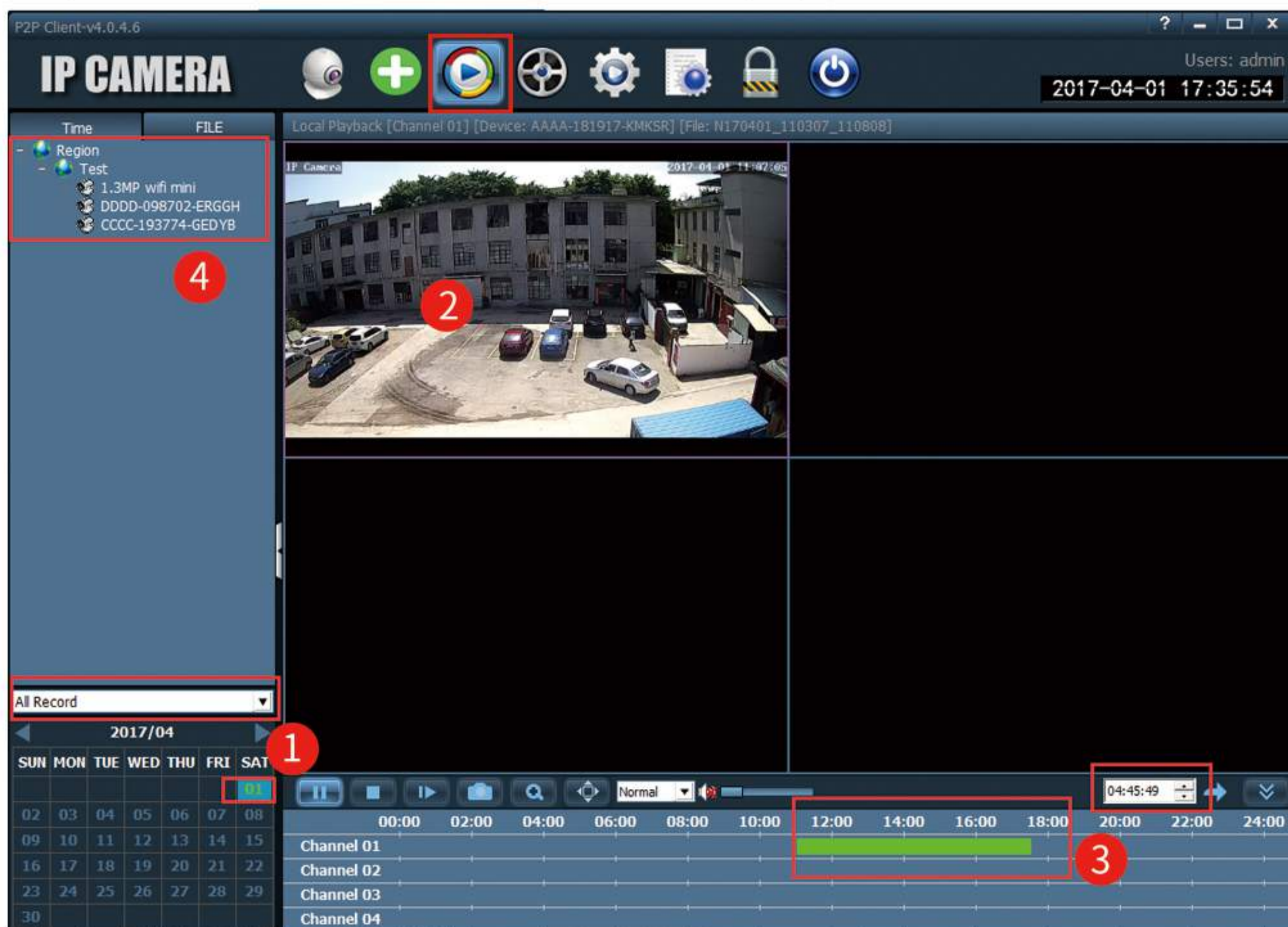

3-7-2. playback by searching file

Step 1: Choose the record file format and device channel

Step 2: Select the search time and click "search" button, the system will display the eligible record file in the device tree.

Step 3: Select playback window and double click record file to playback record.

File playback support the same record file playback in four windows at the same time.



3-8. Remote playback

Remote playback the timing video or alarm video stored in the SD card, select the channel, date, start and end time; Then click “search” to playback the videos which stored in the SD card (remote playback just can be successful as the device connected).

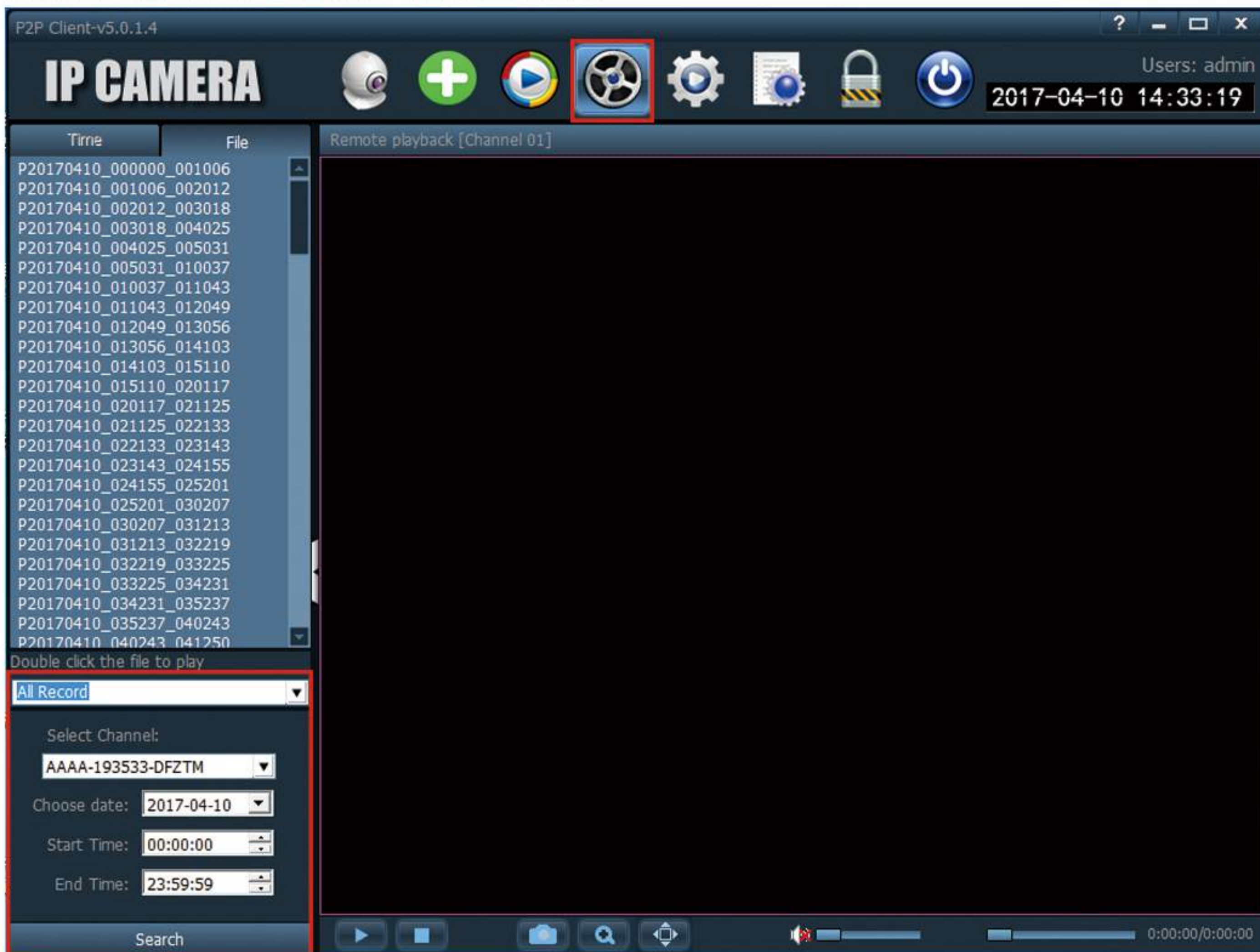

3-9. Parameter Setting

Before modifying the equipment parameters, please connect the related equipment, as shown in the figure below: Connected device.

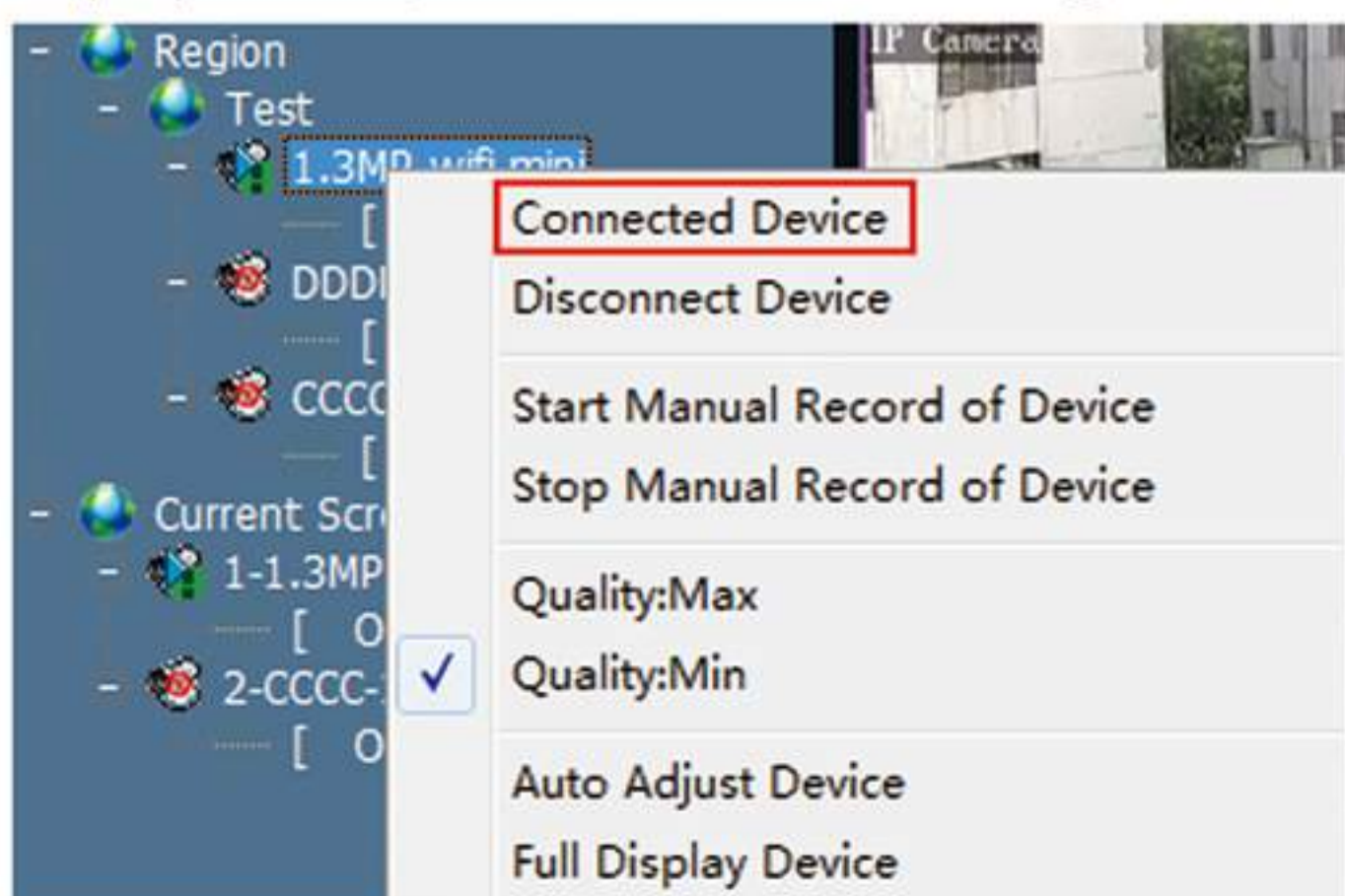

3-9-1. Video

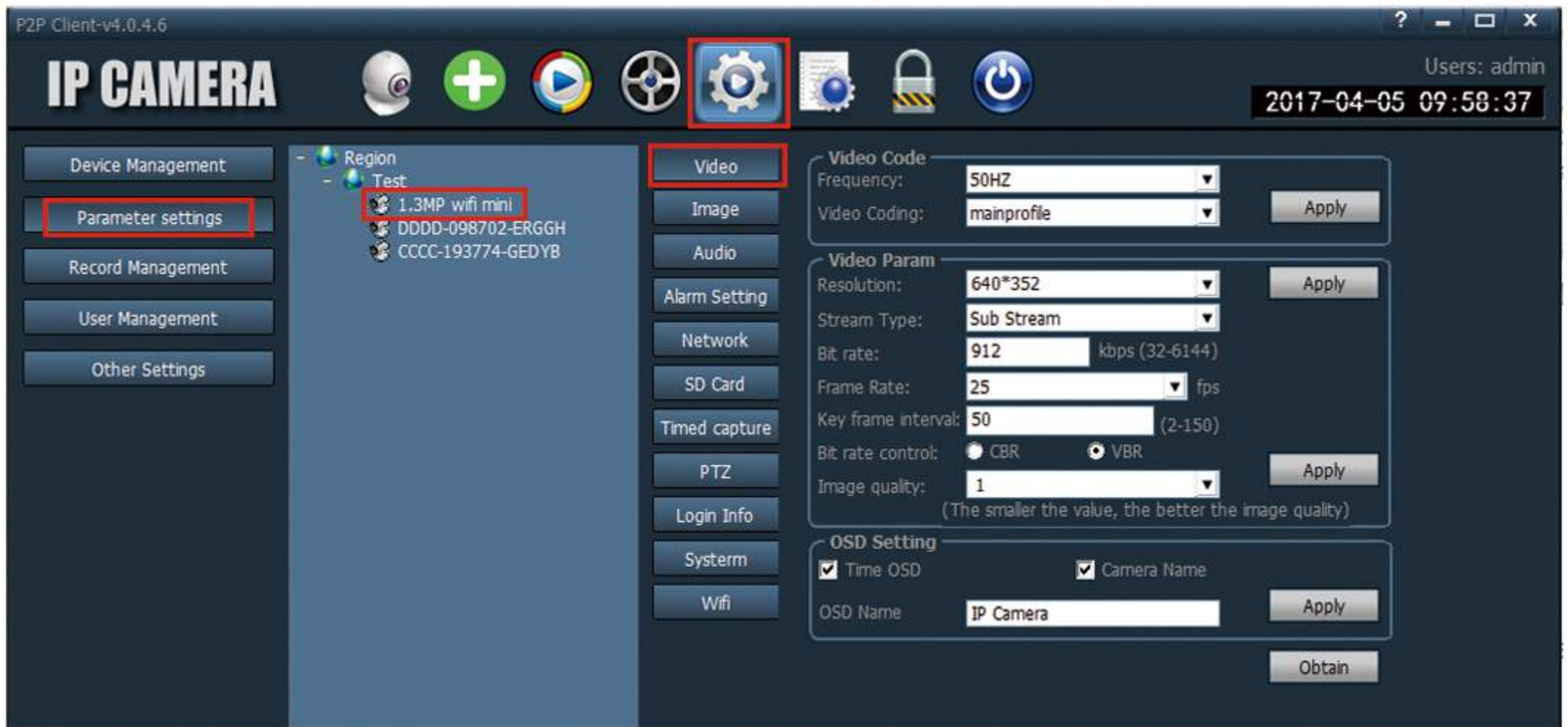

Video code: can set the Frequency and Video coding.

Video Param: Here can set the resolution, stream type, Bit rate, Frame Rate, Key frame interval, Bit rate control, Image quality of video.

OSD Setting: Set the device name and display time.

Note: if the device connection is hd, the resolution is the main stream, if the connection is the standard definition ,the resolution is the sub stream.

3-9-2. Image Setting

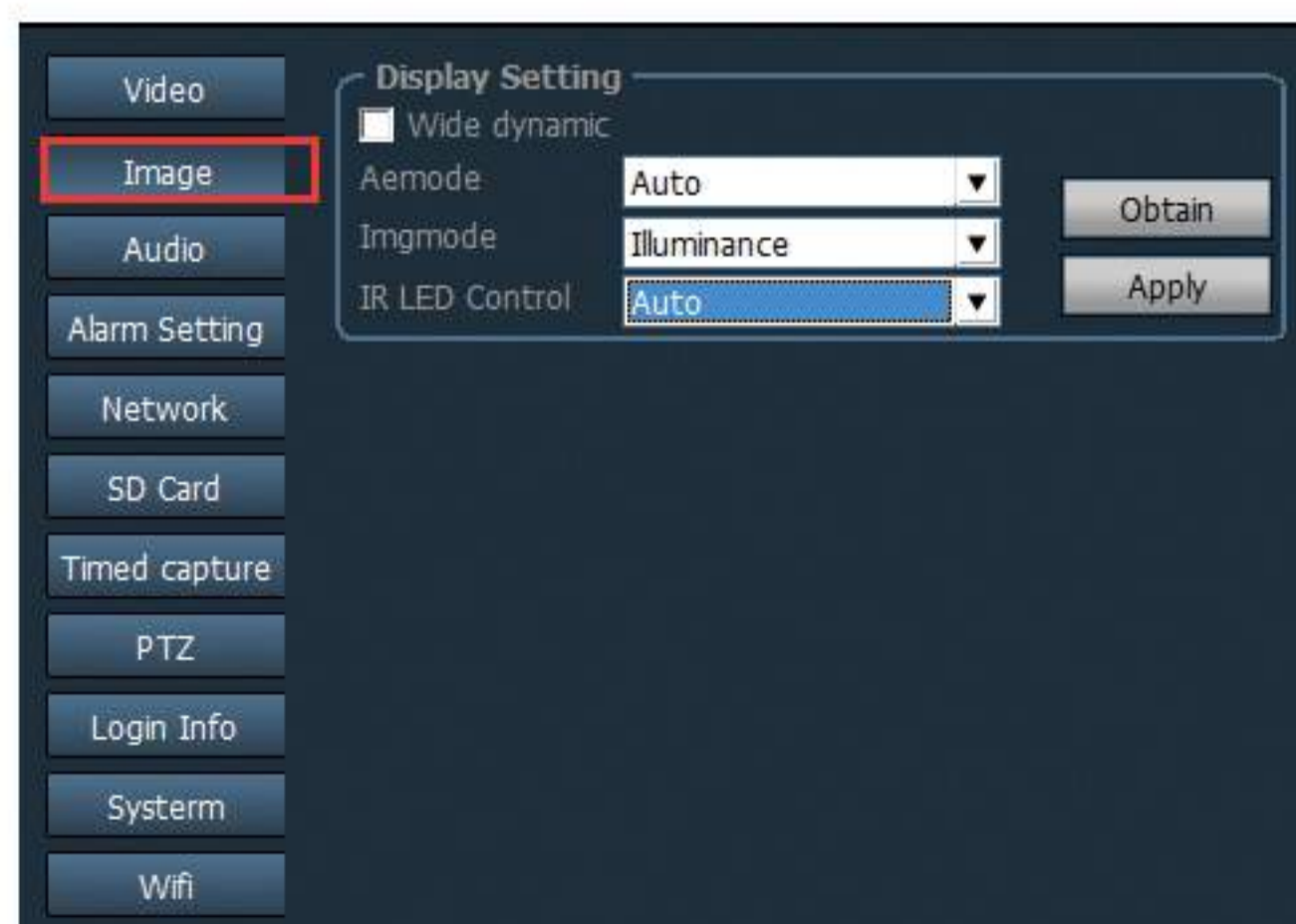

Wide Dynamic: As tick the box in front of “Wide dynamic”, it means the function open. Default is close.

AEmode: Exposure mode. Auto, indoor, outdoor optional. Default is Auto.

Imgmode: Image quality priority mode. Illuminance and Frame rate optional.

IR LED Control: Auto, on, off optional. If open, it will enter into black and white mode. Otherwise will go to color mode.

3-9-3. Audio

Stream type: Main stream and sub stream optional.

Audio capture : ON/OFF optional. Default is off.

Audio type: G.711 and G.726 optional.

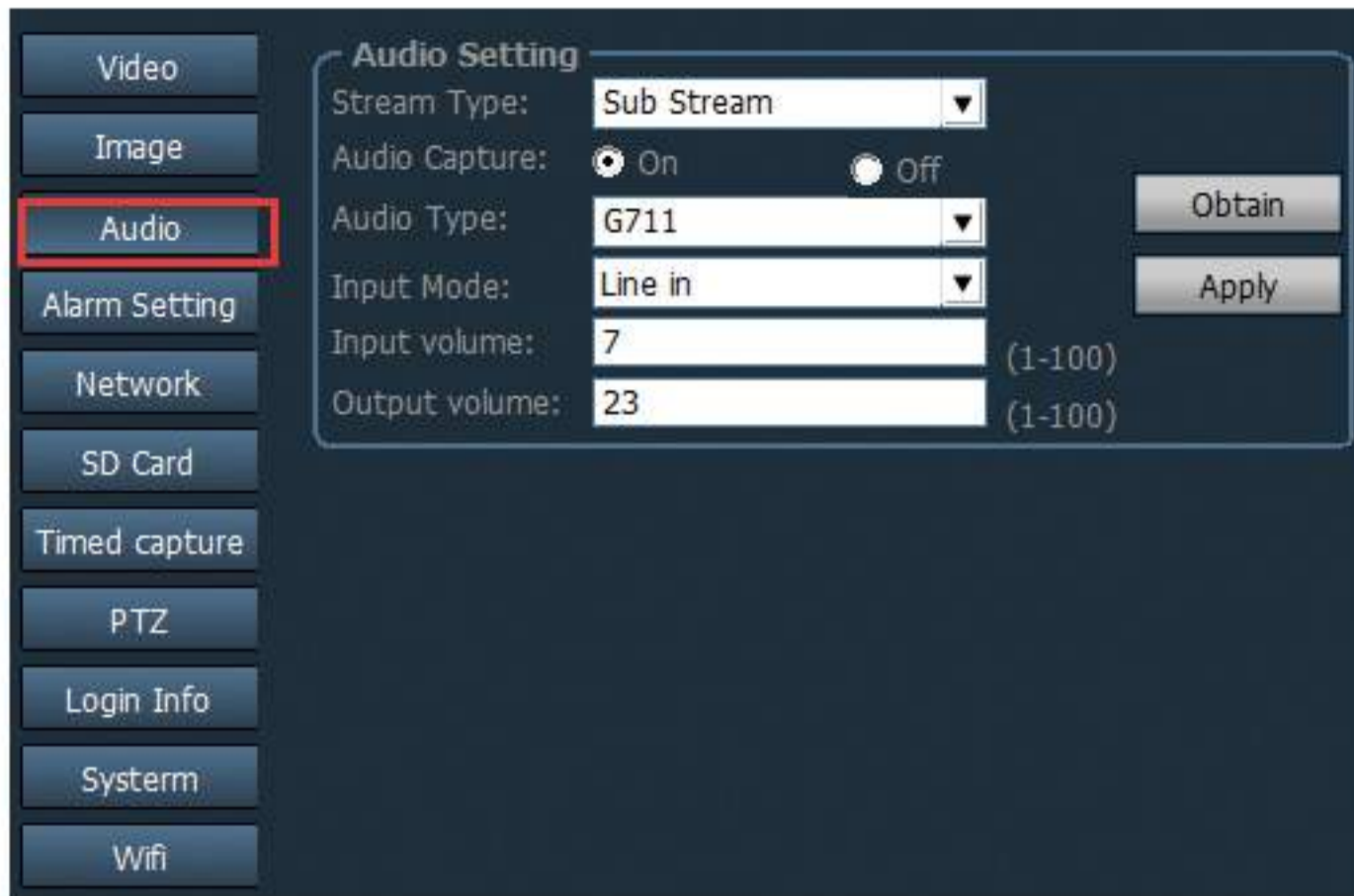

Input mode: Line in, MIC optional.
If choose "Line in", the input/out volume is 15/95. If choose "MIC", the input/out volume is 80/95.

3-9-4. Alarm Setting

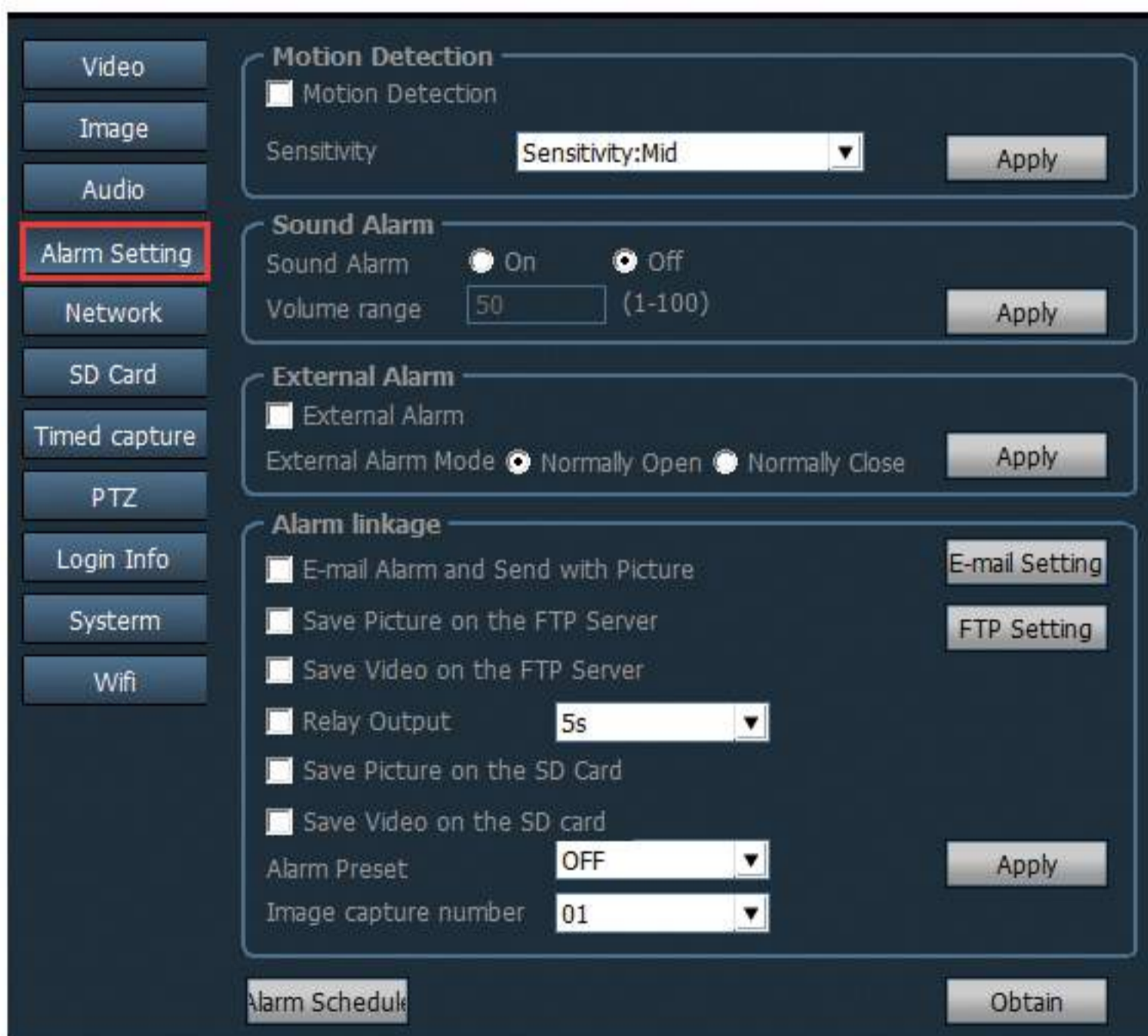

Motion Detection

Tick the box in front of Motion detection to open and close it.

Sensitivity: Low, Middle, High optional. Correspondent sensitivity is 25, 50, 75.

Sound Alarm

Sound Alarm: ON/OFF optional.

Volume range: 1~100 optional. Default is 50.

External Alarm: Open/close optional. (Note: just can use for the camera which support alarm function)

Alarm linkage

E-Mail Alarm and send with picture;
Save picture on the FTP Server;
Save video on the FTP Server;
Save picture on the SD Card;
Save video on the SD Card;



The 'Alarm linkage' window contains several options: 'E-mail Alarm and Send with Picture' (checkbox), 'Save Picture on the FTP Server' (checkbox), 'Save Video on the FTP Server' (checkbox), 'Relay Output' (dropdown menu set to '5s'), 'Save Picture on the SD Card' (checkbox), 'Save Video on the SD card' (checkbox), and 'Alarm Preset' (dropdown menu set to 'OFF'). There are buttons for 'E-mail Setting', 'FTP Setting', 'Apply', 'Alarm Schedule', and 'Obtain'.

Email Setting

Take QQ email for example as follow:
SMTP Server: smtp.qq.com
server Port:465
Encrypt Type: SSL
Username: fill the blank with your email address
password: the password of your email address
Sent To: fill this blank with the email address to receive the alarm snapshots.
Sender: Fill this blank with the Email address which send the pictures.

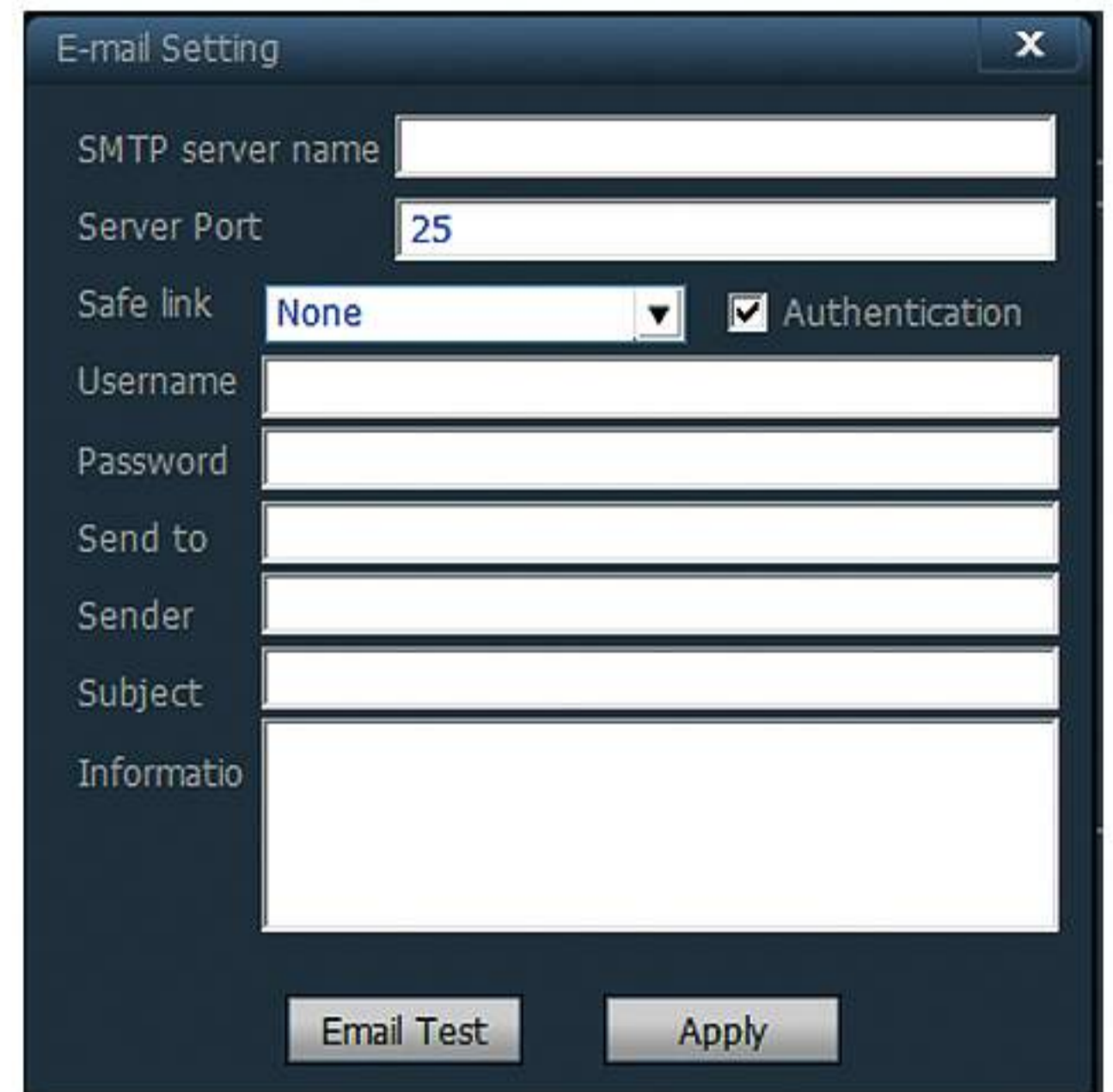

The 'E-mail Setting' window includes fields for 'SMTP server name', 'Server Port' (set to 25), 'Safe link' (dropdown set to 'None'), and a checked 'Authentication' checkbox. It also has fields for 'Username', 'Password', 'Send to', 'Sender', 'Subject', and 'Informatio'. Buttons for 'Email Test' and 'Apply' are at the bottom.

Warm Prompt: All the email "username", "Send to", "Sender" can be the same Email Address. Please ensure the server of IMAP/SMTP&POP/SMTP is ON.
Subject and Message: anything content is ok.
After completed, click "Test" to check the Email setting, if it is successful, click "Apply".

FTP Setting :

Server Address: Fill in the blank with the FTP address.
Server Port: Fill in the blank with the FTP port.
User Name: Fill the blank with the username of the FTP server.
Password: Fill the blank with the password of the FTP server
Auto Create Dir: If tick it, it will create directory automatically. The name of directory is the date time.

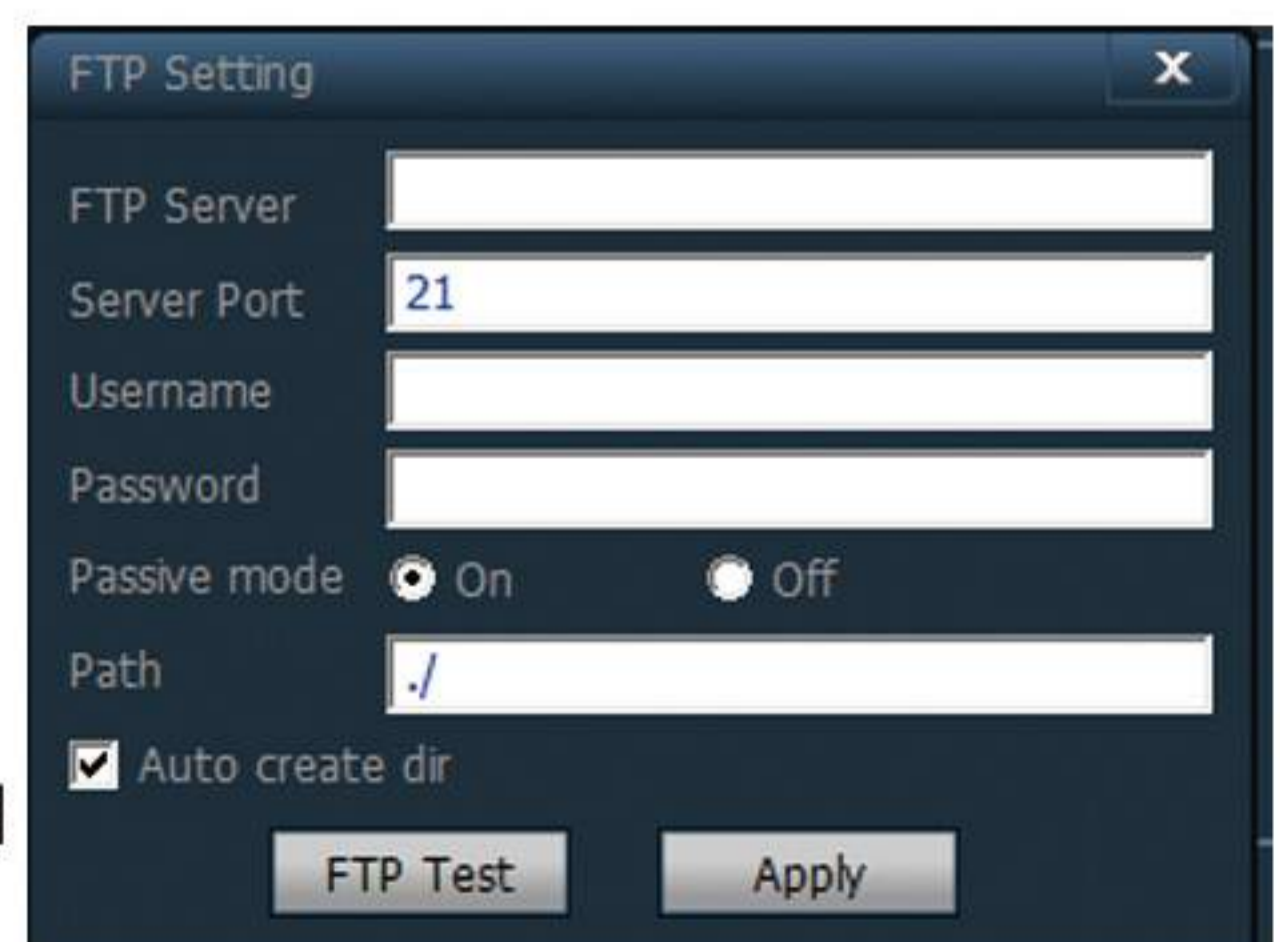

The 'FTP Setting' window has fields for 'FTP Server', 'Server Port' (set to 21), 'Username', 'Password', 'Passive mode' (radio buttons for 'On' and 'Off', with 'On' selected), and 'Path' (set to '/'). There is a checked 'Auto create dir' checkbox and buttons for 'FTP Test' and 'Apply'.

Alarm Schedule

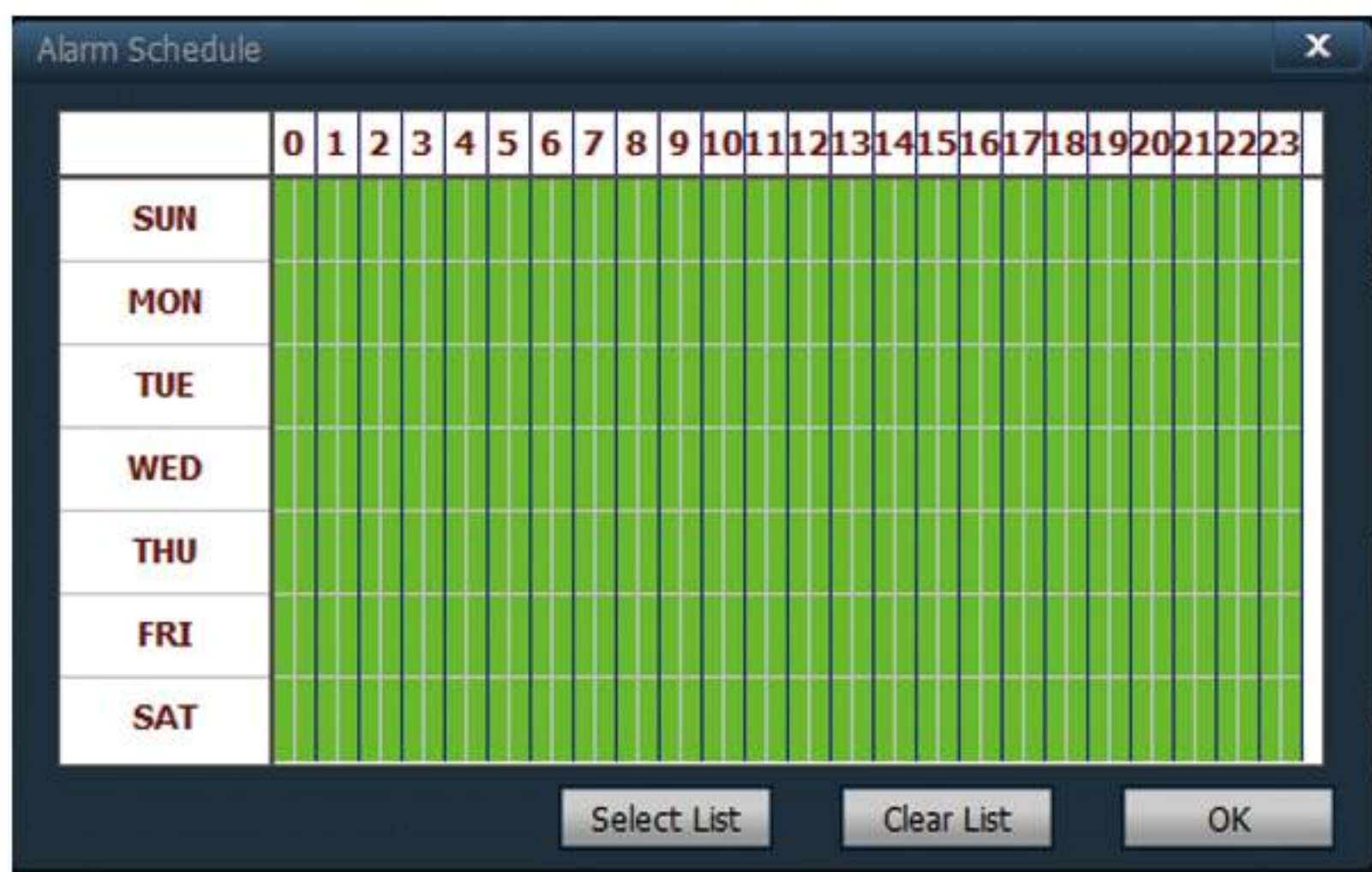

SUN~SAT show one week from Saturday to Sunday. Half an hour as for the unit.

3-9-5. Network Setting

Network Setting: network Parameter configuration. DHCP Auto/DNS Auto optional to get IP Address.

RTSP Port: can set RTSP port and RTSP Permission check.

ONVIF Setting: ONVIF ON/OFF, Sever port, time zone setting, image setting etc.

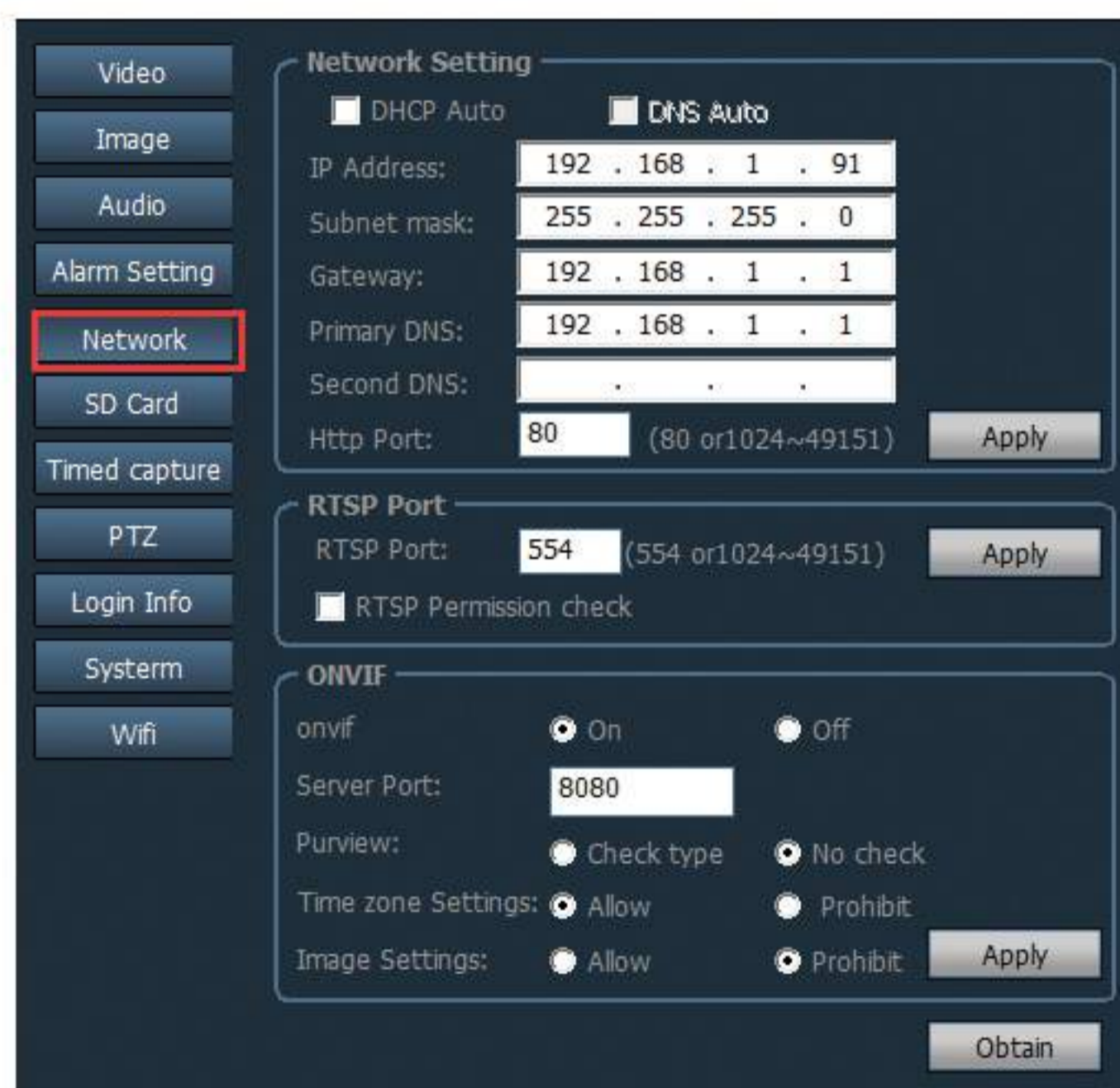

3-9-6. SD Card

Enable the plan of record: tick it to start the plan of record.

Stream Type: Main Stream/Sub Stream/Third stream optional.

Record Length: 15~900sec optional . default is 600sec.

Format SD: click it to format SD card.

Record time setting: right green area is the recording time.

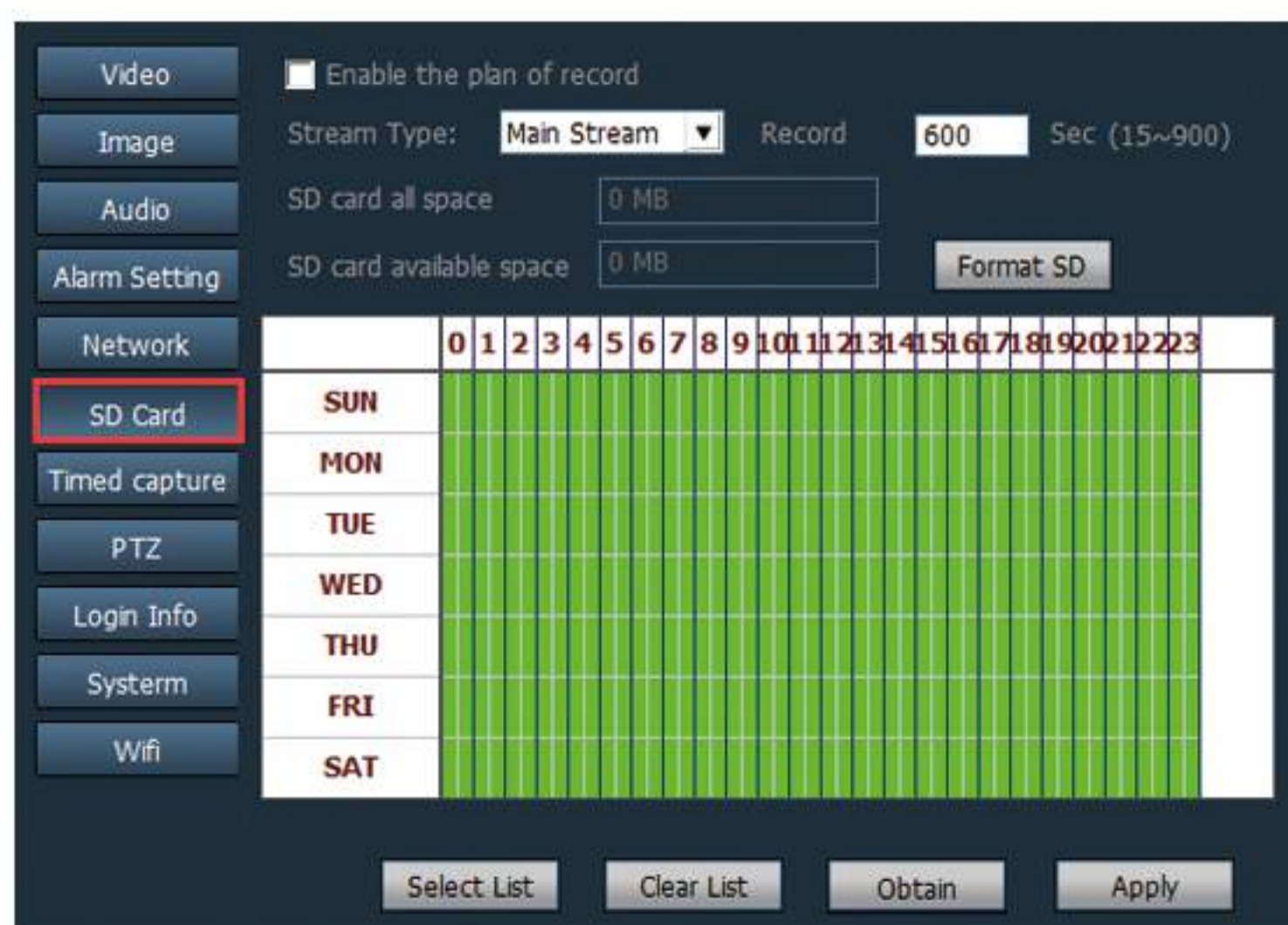

3-9-7. Timed Capture

If tick "Save picture on the SD Card", the camera will capture a picture each 60s and storage it to the SD card.

If tick "Save picture on the FTP Server", the camera will capture a picture each 60s and send it to the FTP server.

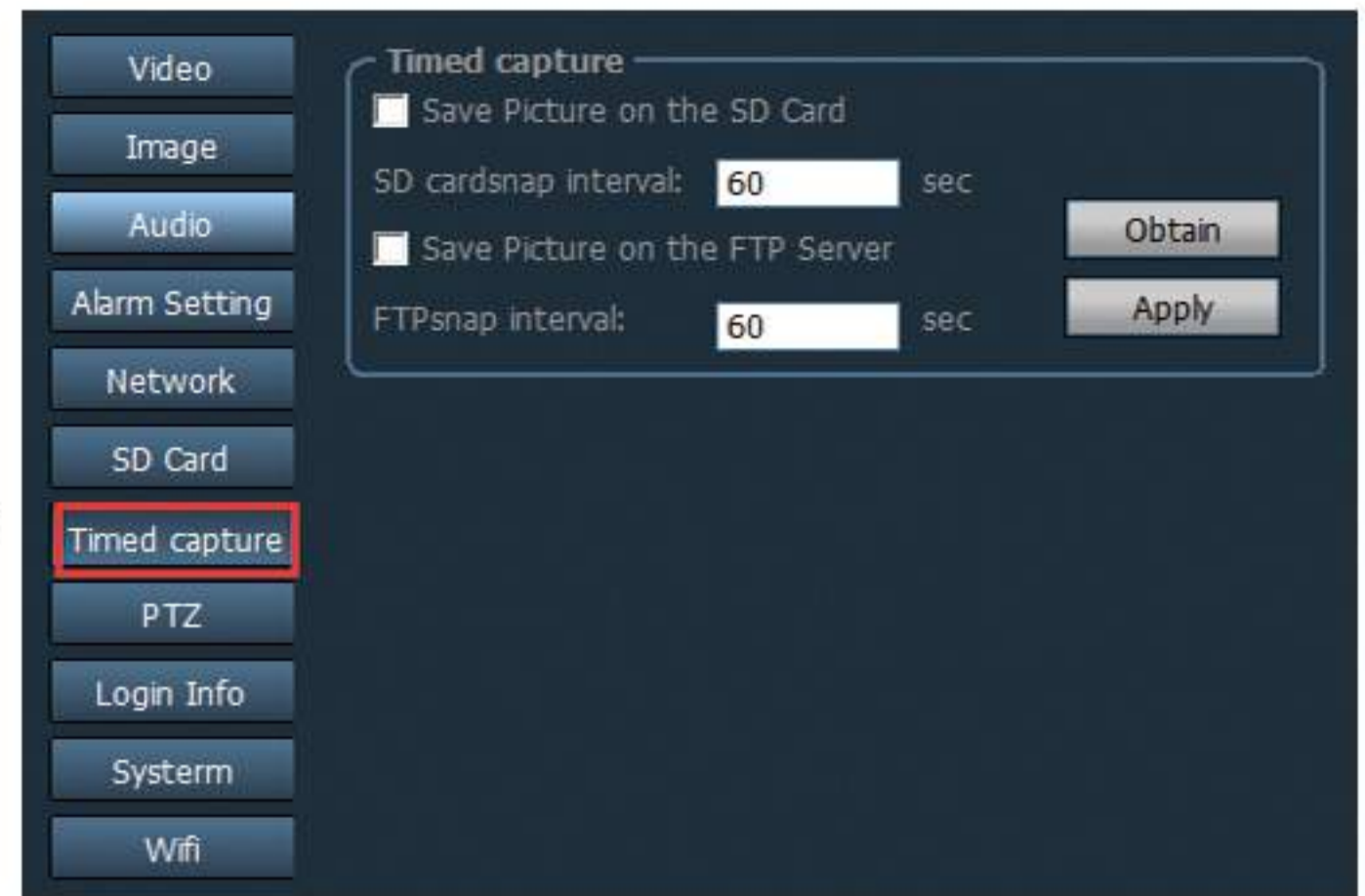

3-9-8. PTZ

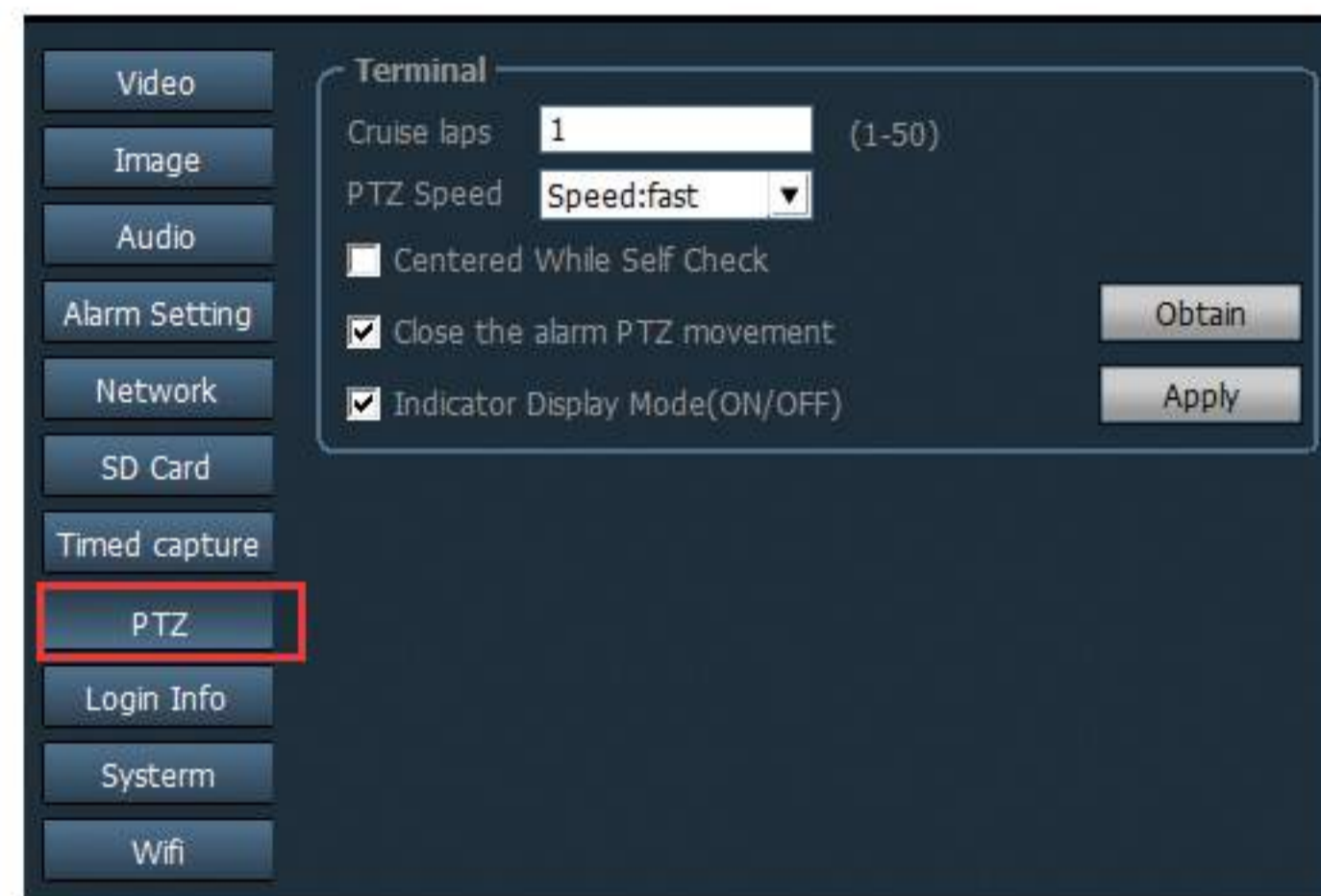

The setting come with Cruise laps, PTZ speed, Centered while self check, close the alarm PTZ movement, Indicator Display Mode ect.

3-9-9. Login Info

Can modify the password of the device.

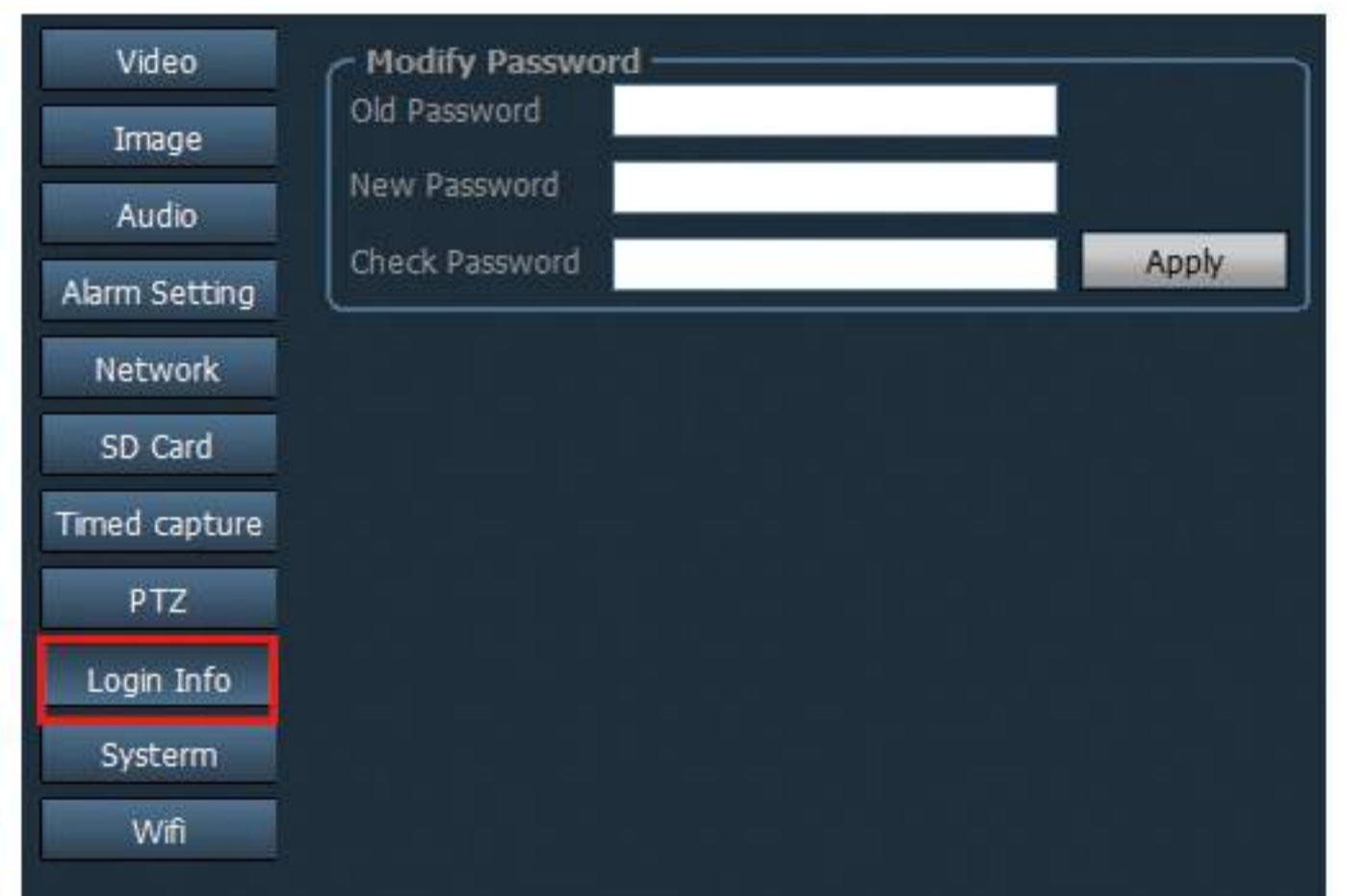

3-9-10. System

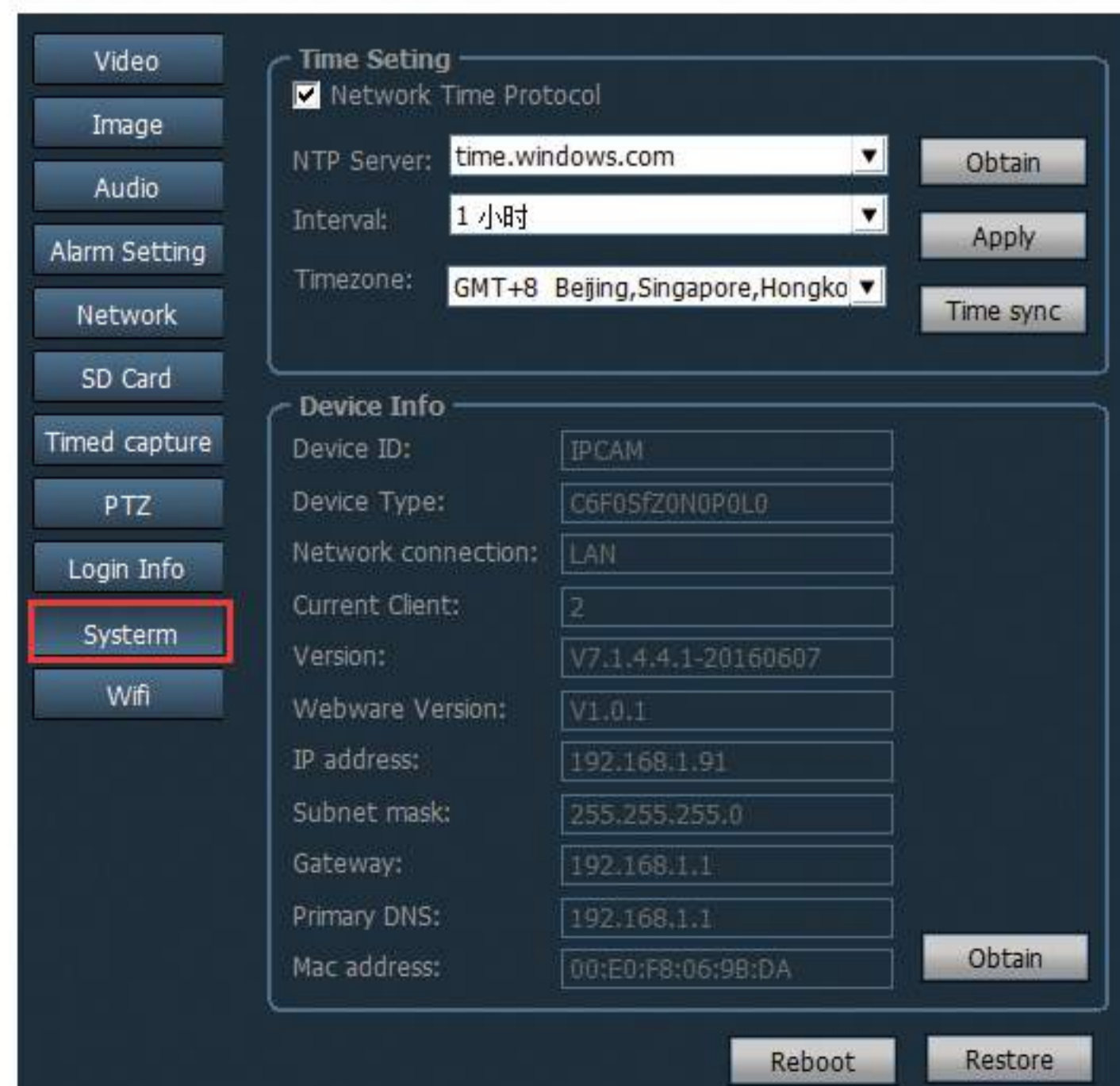

Network Time protocol: include the NTP Server, time interval, time zone setting.

Device Info: from here can get the information like Device ID, software version, IP address, MAC address. Reboot and restore the device.

3-9-11. WIFI

Steps of WIFI setting

Step 1. Click , then click .

Step 2. Double click SSID of WIFI.

Step 3. Input the WIFI password.

Step 4. Click Apply, after it notify successful, click WIFI check.



3-10. User Management

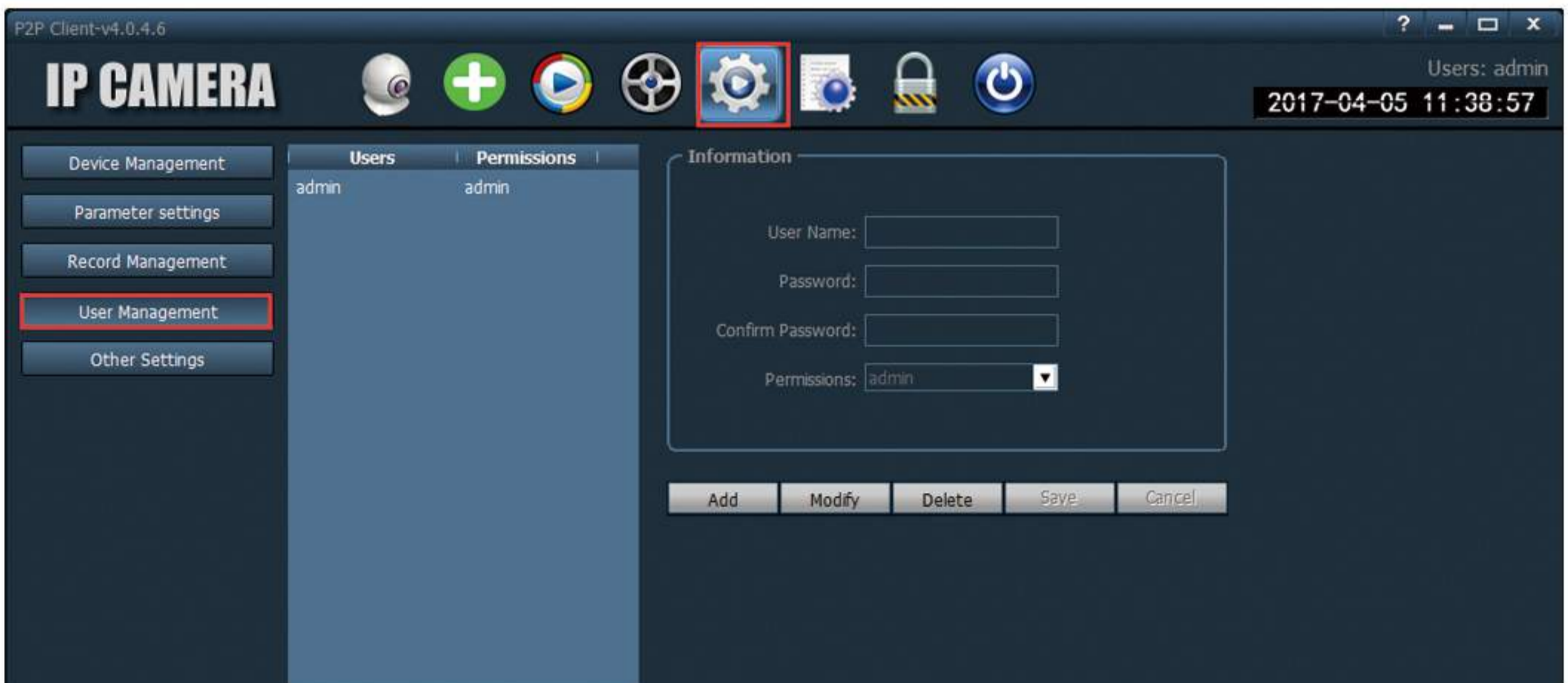

The default username is “admin”, password is empty. After log in by administrator, he can add and delete user, set user permission. User permission has three types: admin, user, guest.

Admin permission: can undertake device management, user management, video surveillance, record playback, map Settings, log query, switch users and exit from the client;

User permission: can undertake video surveillance, video playback, map Settings, log view, switch users and modify password.

Guest permission: can undertake video surveillance, switch user and modify password.

3-10-1. Steps of Adding User

Step 1: After log in by admin permission, select "Settings" in the TAB bar - "usermanagement".

Step 2: Click "Add" to input the user name and password, and choose the permission.

Step 3: Click "save", user added successful.

3-10-2. Delete user

Step 1: After log in by admin permission, select "Settings" in the TAB bar -- "usermanagement"

Step 2: Choose user want to delete, and click "delete" button.

3-10-3. modify user permissions

Step 1: After log in by admin permission, select "Settings" in the TAB bar - "user management"

Step 2: Select the user and click "edit" button

Step 3: Select the user permission and click "save" button.

3-10-4. modify user password

Step 1: In the TAB bar, select the "Settings" -- "user management"

Step 2: Select the user and click "edit" button

Step 3: Enter a new password and click "save" button

3-11. Other settings

Connect timeout: 5~60sec optional.

Log retention time: 1/ 2/ 3/ 6 month optional. Clients log won't delete during the setting time.

Capture format: the format of the capture image. There are JPG and BMP format.

Image capture path: the storage path for the captured images.

Start the software automatically connect all devices: As the windows start, the CMS software automatically load .

Single Screen number: 16/25/36 pictures optional.

Display Mode: Direct 3D/Direct Draw optional.

Password: set the default password when add the device.

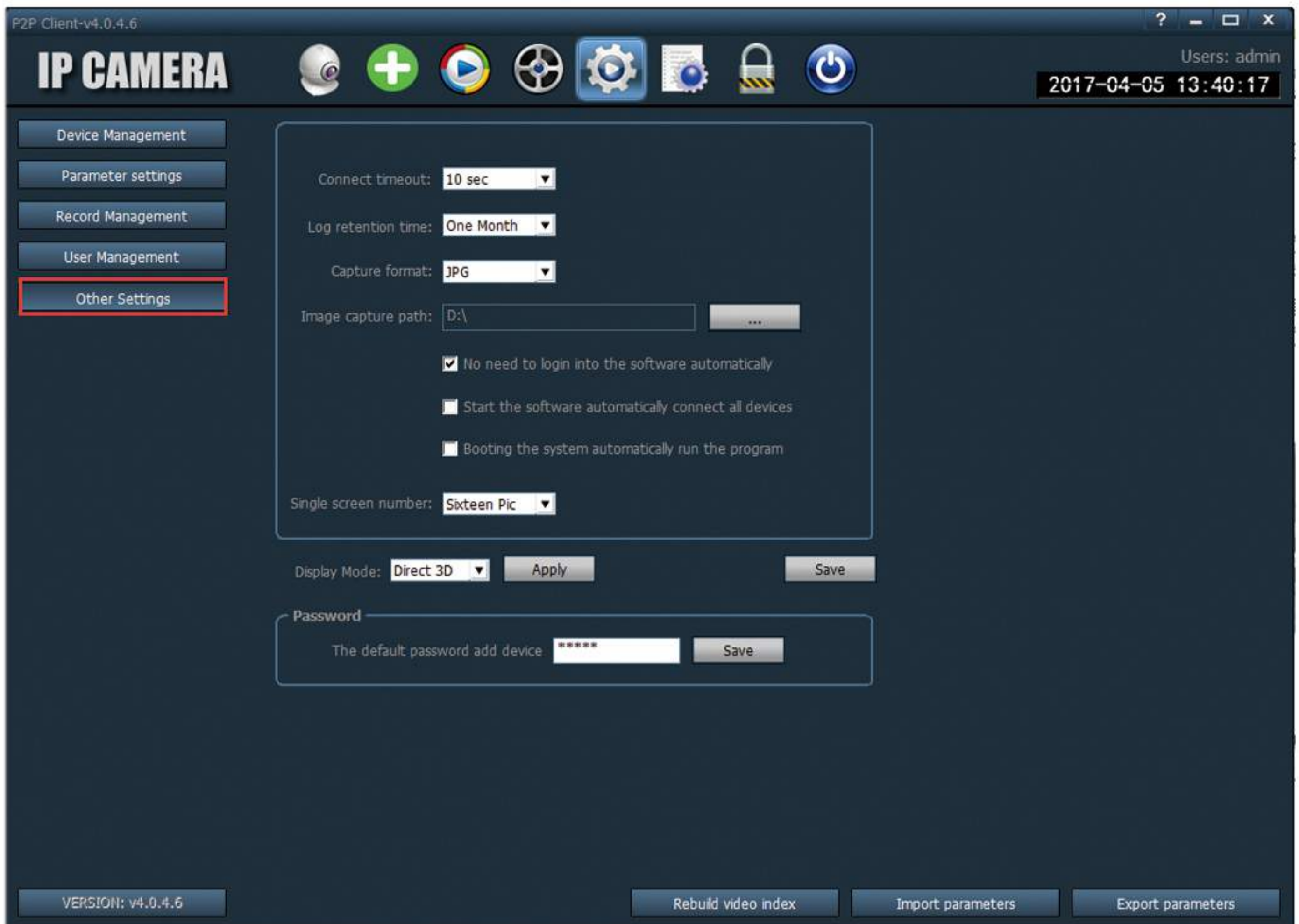

save: after modify the parameters, click the “save” to confirm it.

Export parameters: import all setting parameters of the CMS (back up the configuration).

Import parameters: Import and recovery the back up configuration from other CMS(It require the version is same for the two CMS, otherwise it will bring some errors)

Rebuild video index: Delete the video index and rebuild it.

3-12.Logs

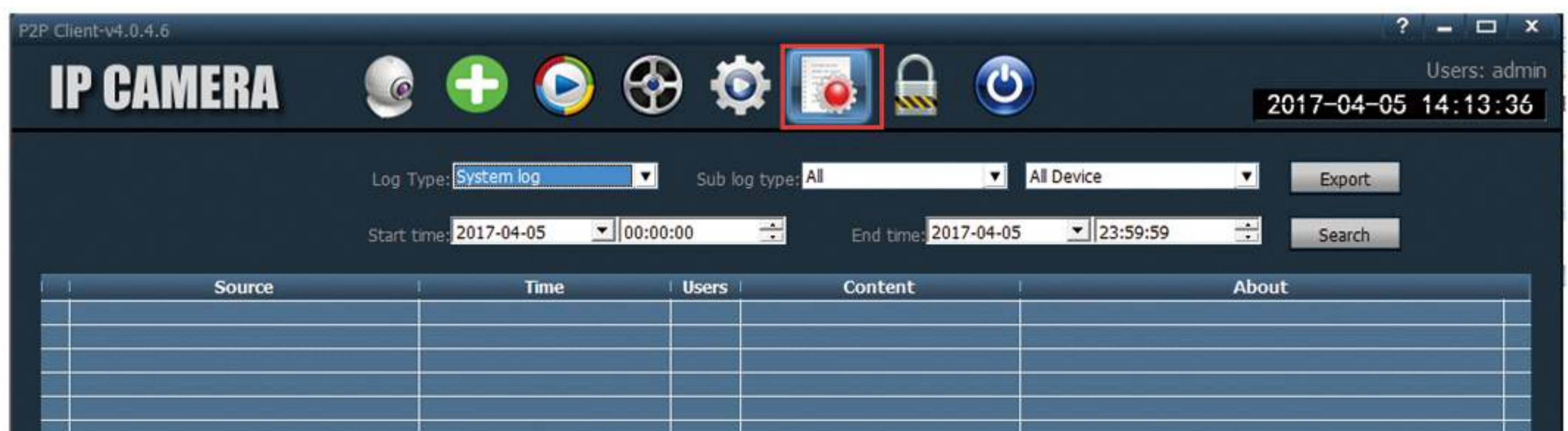

log type

All logs: record all information of system.

System Log: record the user login, exit, and user configuration etc.

Operation log: Record all operation information from users.

Recording device alarm information.

3-12-1. Log retention time

Step 1: In the tab bar, select the "setting"- "other settings".

Step 2: Select "log retention time" ,There are 1/2/3/6 month optional.
Click save.

3-12-2. Log query

step 1: Select a log type and sub log type.

Step 2: Choose the device to view log, default is "all devices".

Step 3: Choose the start time and end time of querying log and click "search" button

3-12-3. Log backup

Step1: Select a log type and sub log type

Step 2: Choose the device to view log, default is all devices

Step 3: Choose the start time and end time of querying log and click "search" button

Step 4: Click the "export" button, and choose the path of backup

Note:

1. When backup log, you must search log firstly, then backup.

2. The export log format is Excel format.

3. Each excel table only can save 5000 pieces log, if the quantity exceed 5000, the left log will form another excel table.

Quick connection for Internet explorer viewing

1.To find the IP Address of the camera

① Ensure the camera connected to Internet, then find the IP from the phone APP (refer to page 14: Device information), or from the PC client (refer to page 30: network Settings)

② Or you can search and change the IP through the search tool.

Pls find the "Search Tool" from the CD or contact our after-sales.

As the camera in the coverage of internet. Open the software search tool , it will pop-up a interface as picture 1-1, click "Next", All the IP address in the LAN will come out(As the picture 1-2), click the IP Address which you want to modify, then click"next".



(picture 1-1)



(picture 1-2)

Then come to the next interface (as shown in figure 1-3) software will automatically change the IP address of the camera, no need manual changes, click "next", then come the windows as picture 1-4. And click "Finish".



(picture 1-3)



(picture 1-4)

2.View from the Internet Explorer

Open the IE browser and input the Modified IP address of camera, Then come out the interface as picture 1-5, Input the user name and password (the default user name: admin, the default password: admin), and click “ok” Into the next interface (as shown in figure 1-5), click "PC View" into the main interface(as picture 1-6).

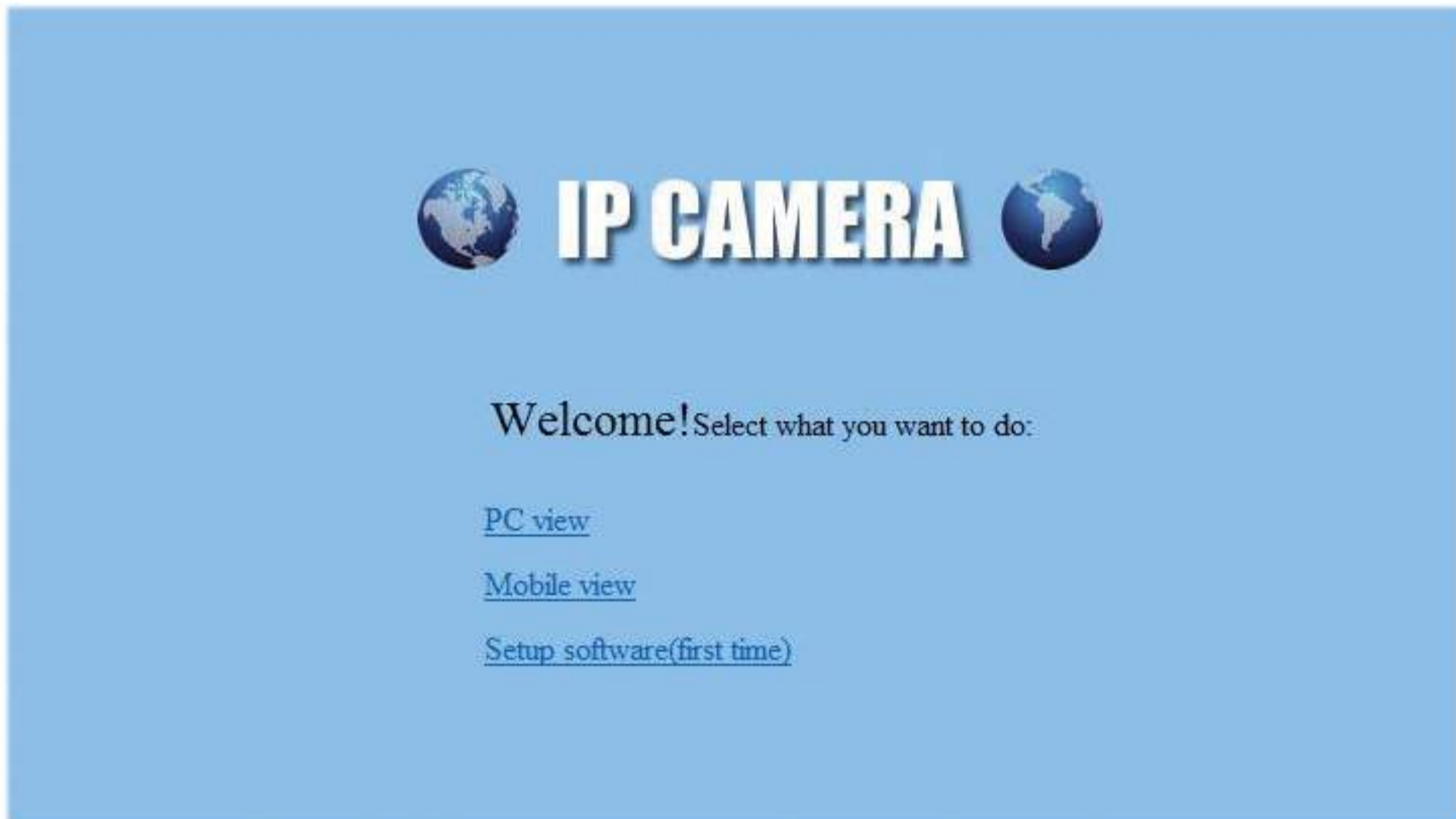

(picture 1-5)

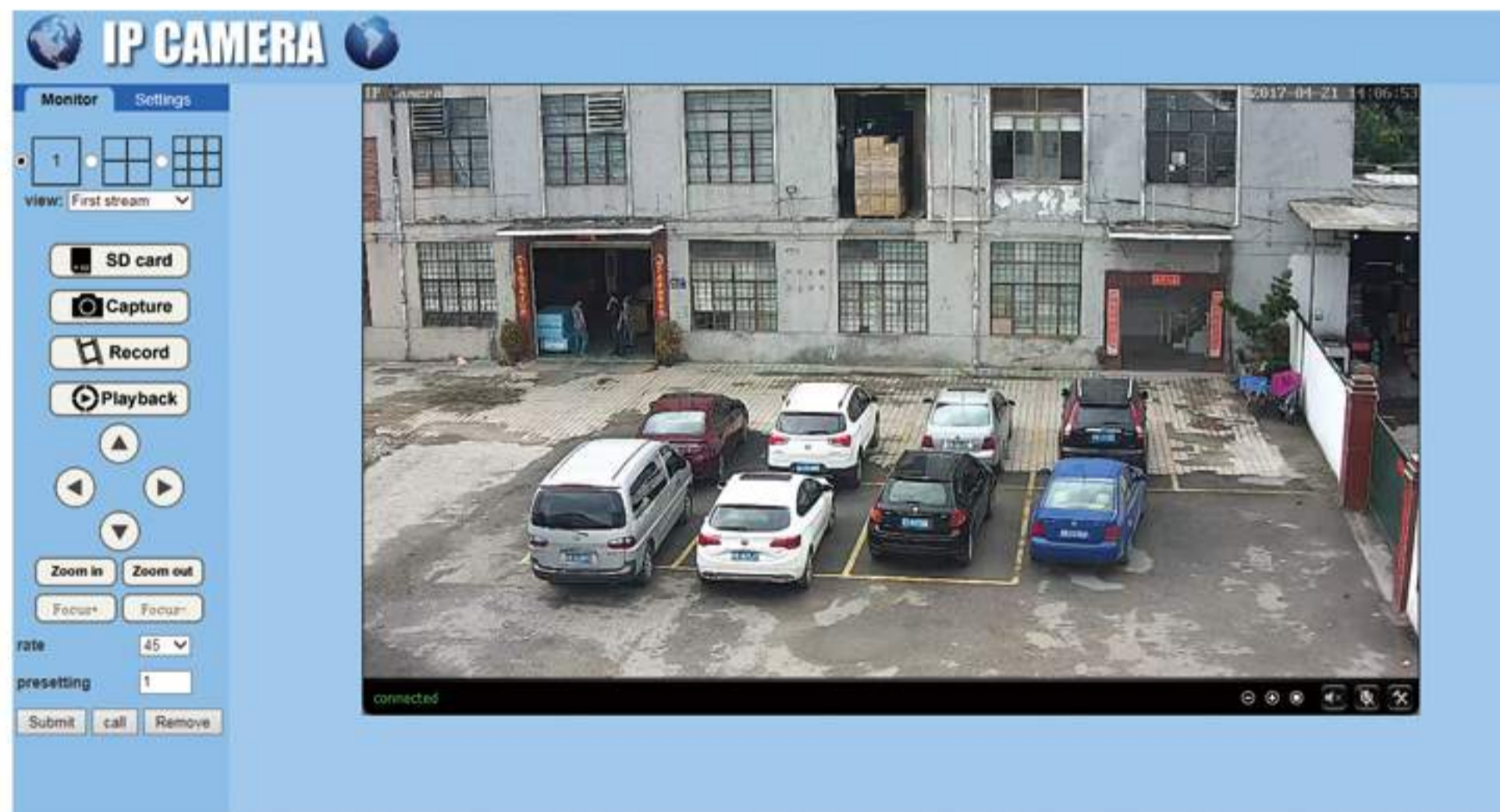

(picture 1-6)

Note: Initial IE browser use need to download the Active-X control .Active-X MsgBox will popup as the camera IP address running in IE browser. After install the Active-X, need to refresh the webpage.

3. IE View Setting

Please refer to the setting of PC CMS. Most of the function are similar.

Others

1. Installation Instructions for wall mounting

Separate the iron plate from the bracket, and install it to the wall. Then cross the cable of the camera through the bracket and make the 0 degree point in the same level of the bracket. Then fix the screw between the bracket and camera. And hung up the bracket to the fixed iron plate, then fix the screw between the plate and bracket.

Wall mounting drawing :

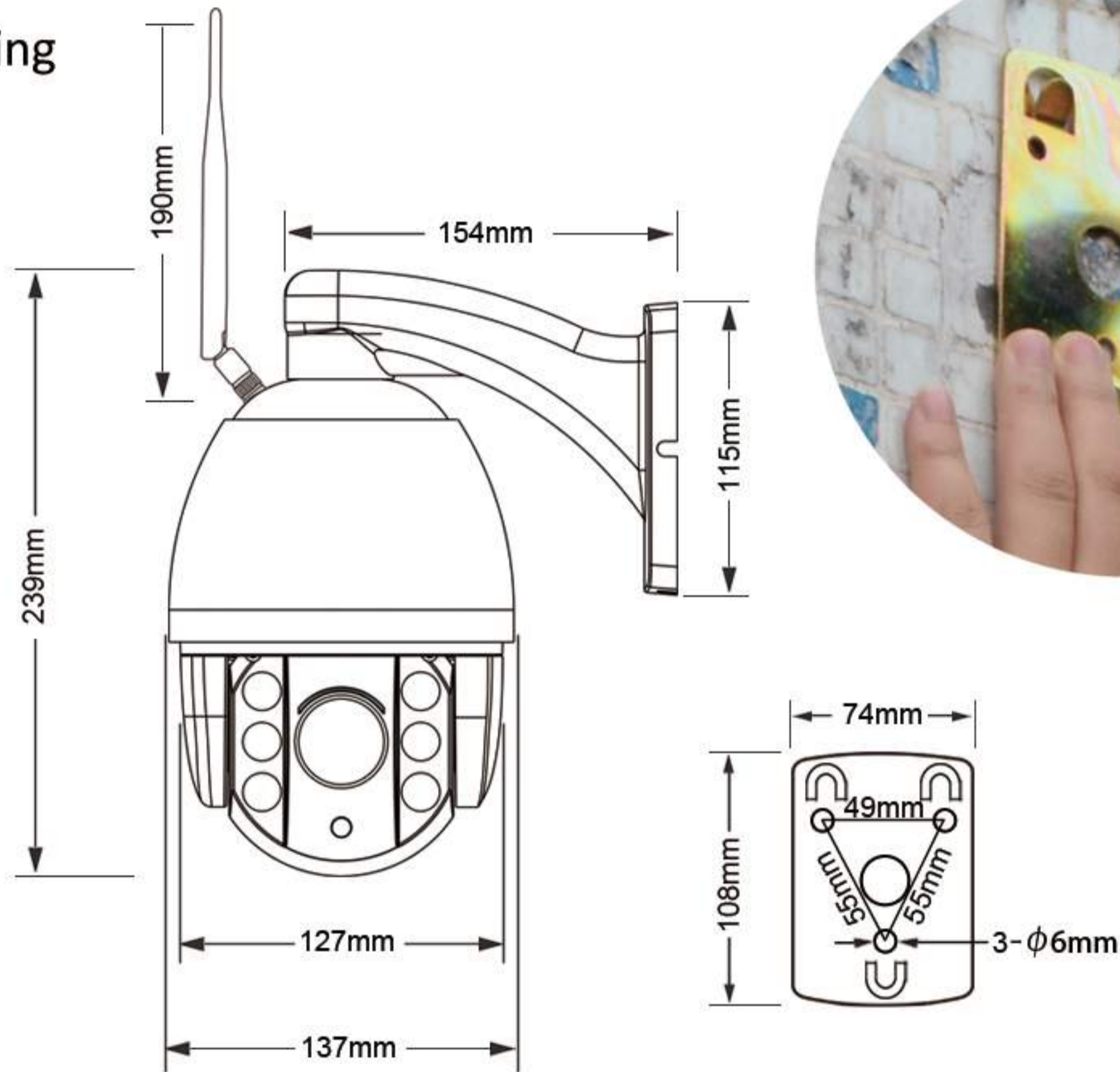

Ceiling drawing:

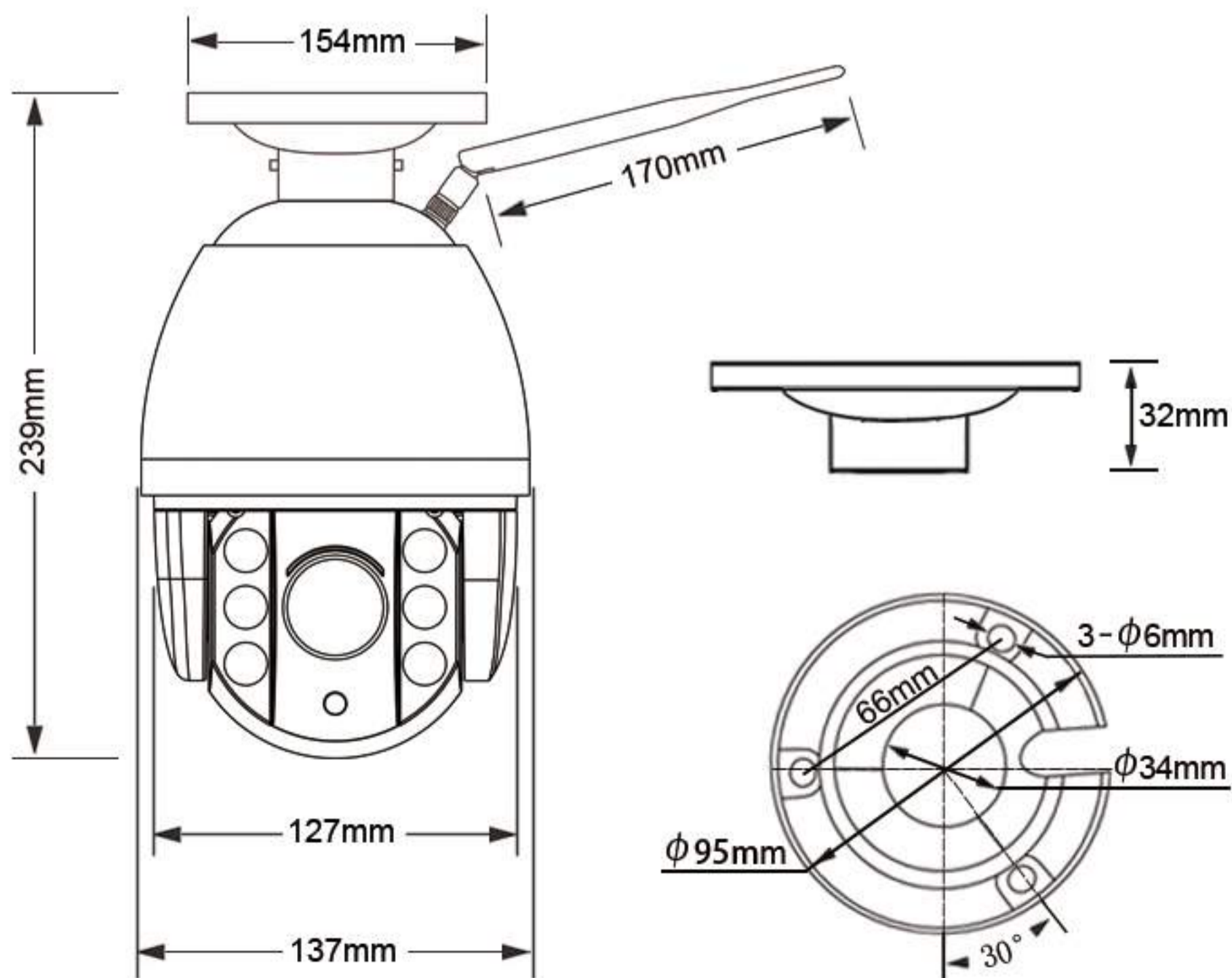

2.The position of TF card

This device is built in TF card, it is forbidden to dismount by non-professionals. If have to dismount, please do it like as this: Unscrew the 4 screws of the face cover firstly, then unscrew the screws of the chipset to find the TF card.

the position of TF Card

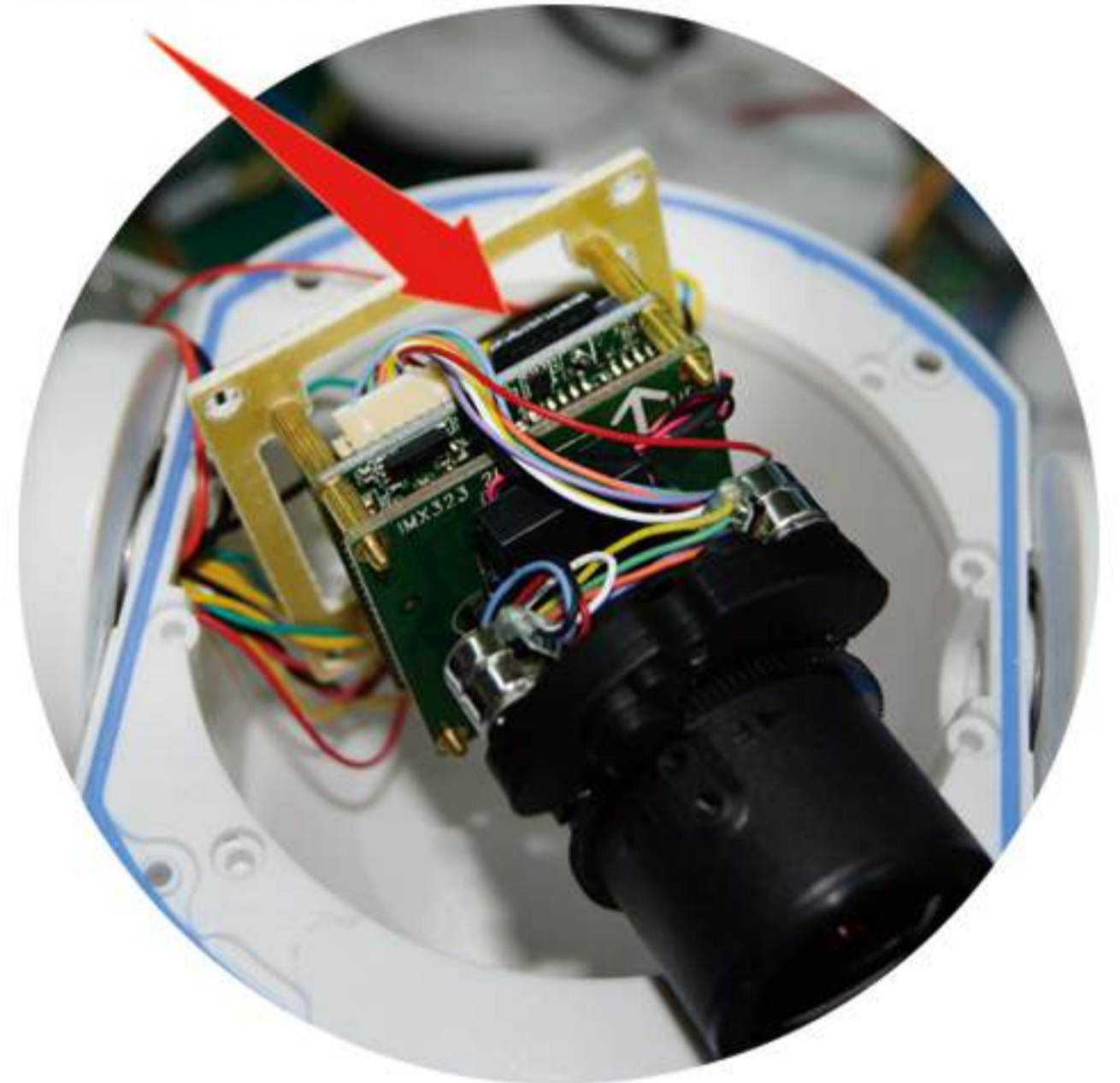

3.Comparison for different functional cameras

Normal End cable

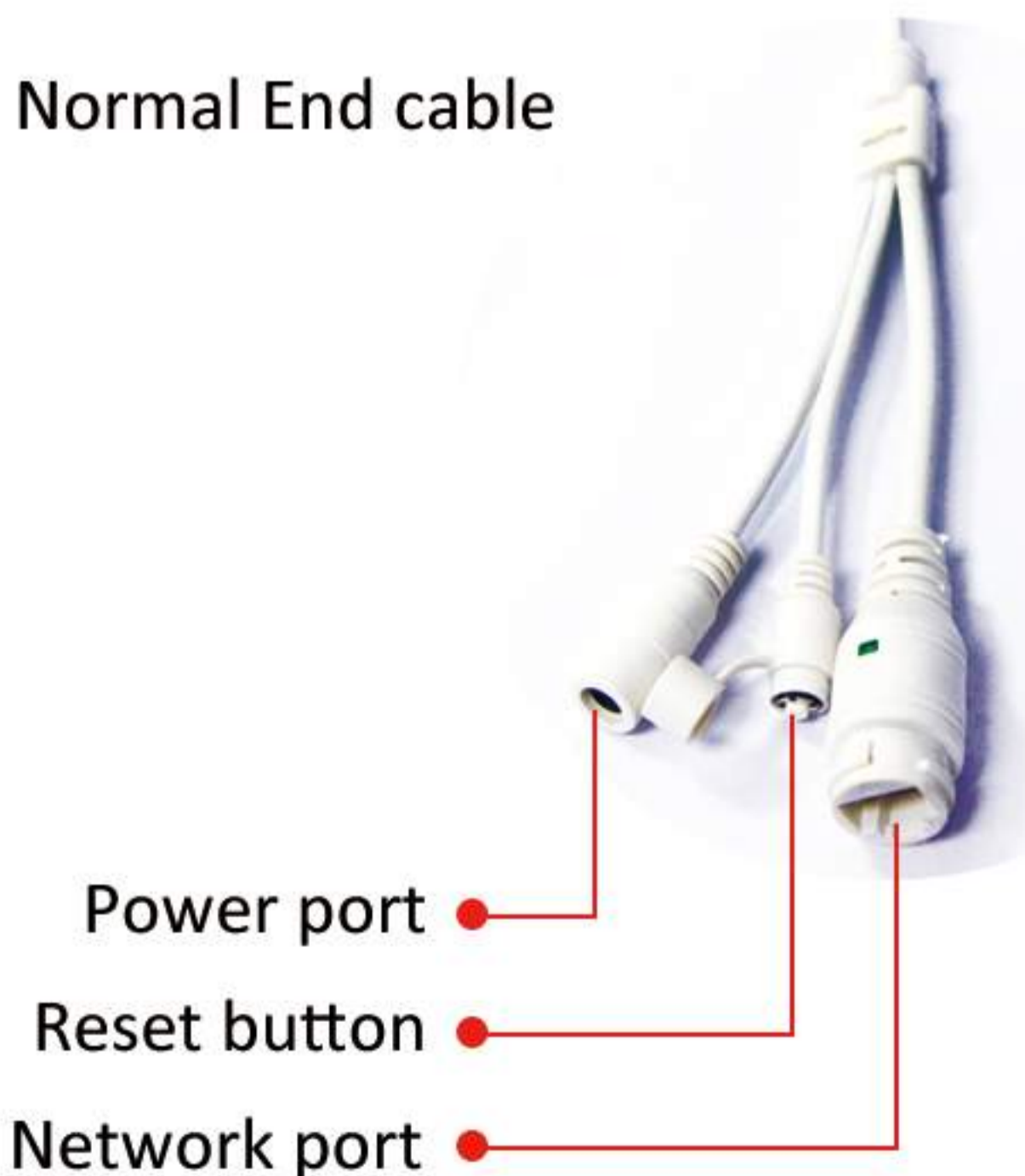

Audio input/
output End cable

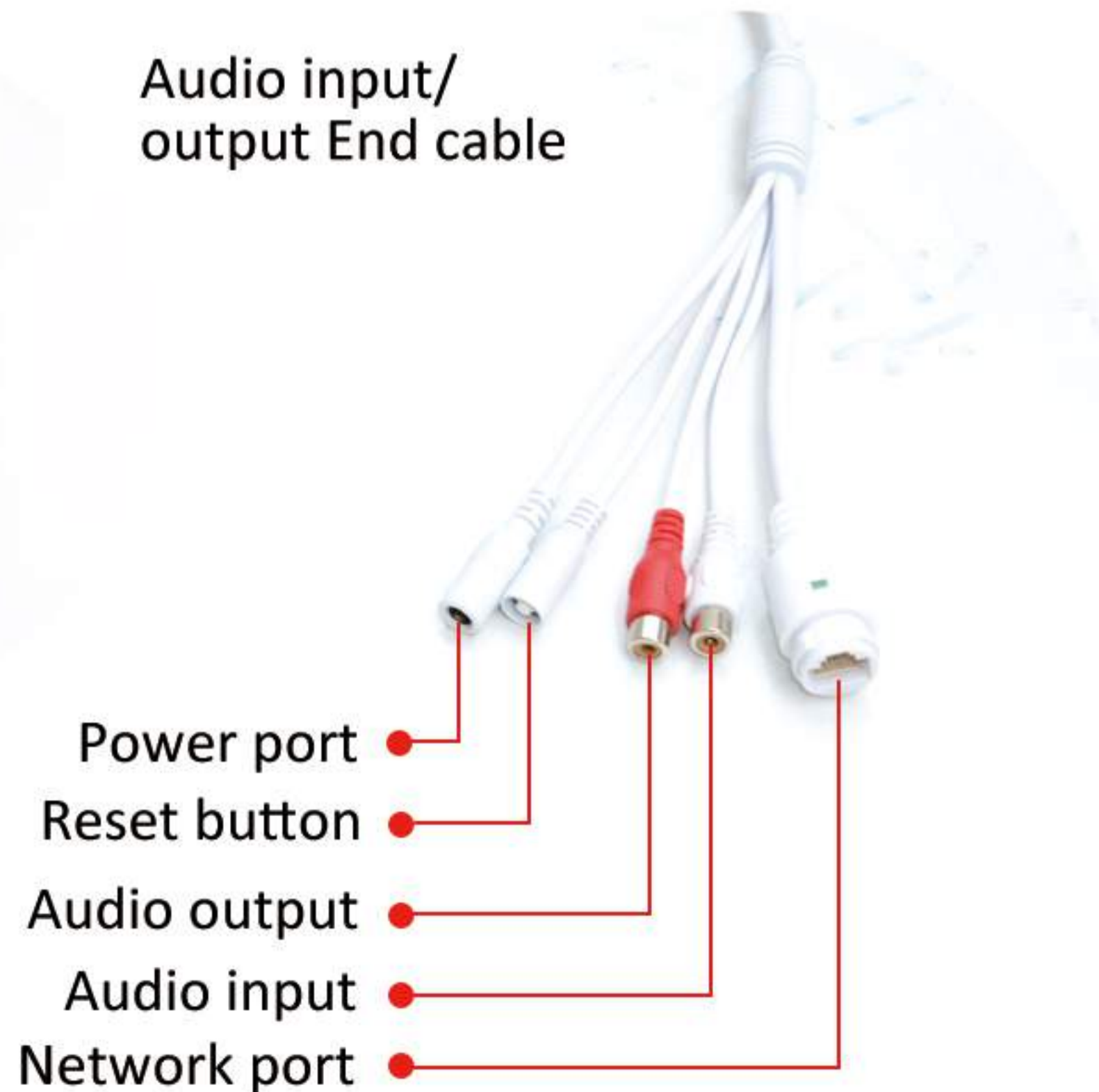

Full functional end cable

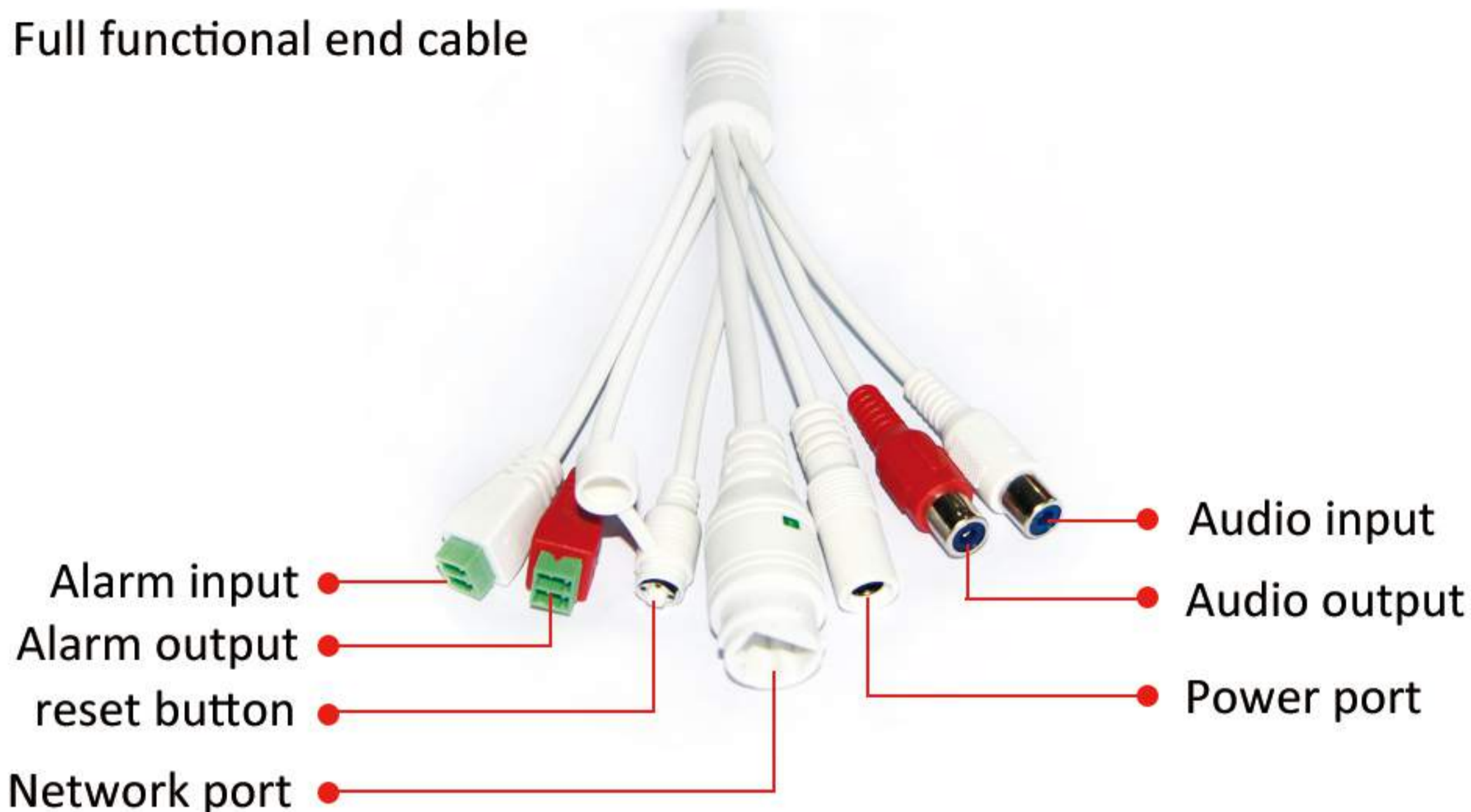

4.How to export the videos which stored in the TF card

4-1.the steps to export the videos from TF card.

Enter into the PC CMS-remote playback-search recorder-right mouse click-choose "download file"

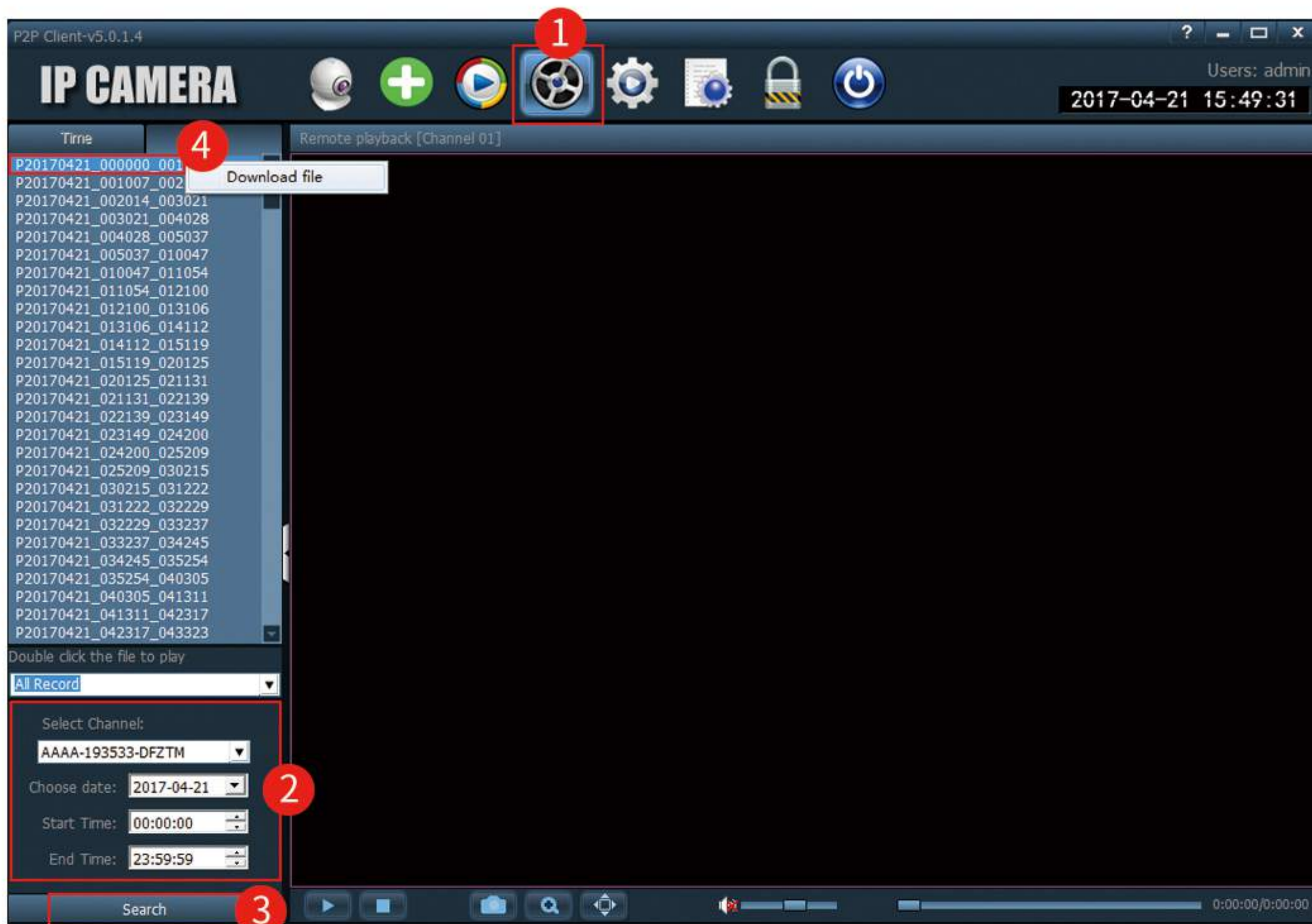

4-2.The conversion of video format

Back to Application Bar, and open “264 converter”, as below screenshot show:

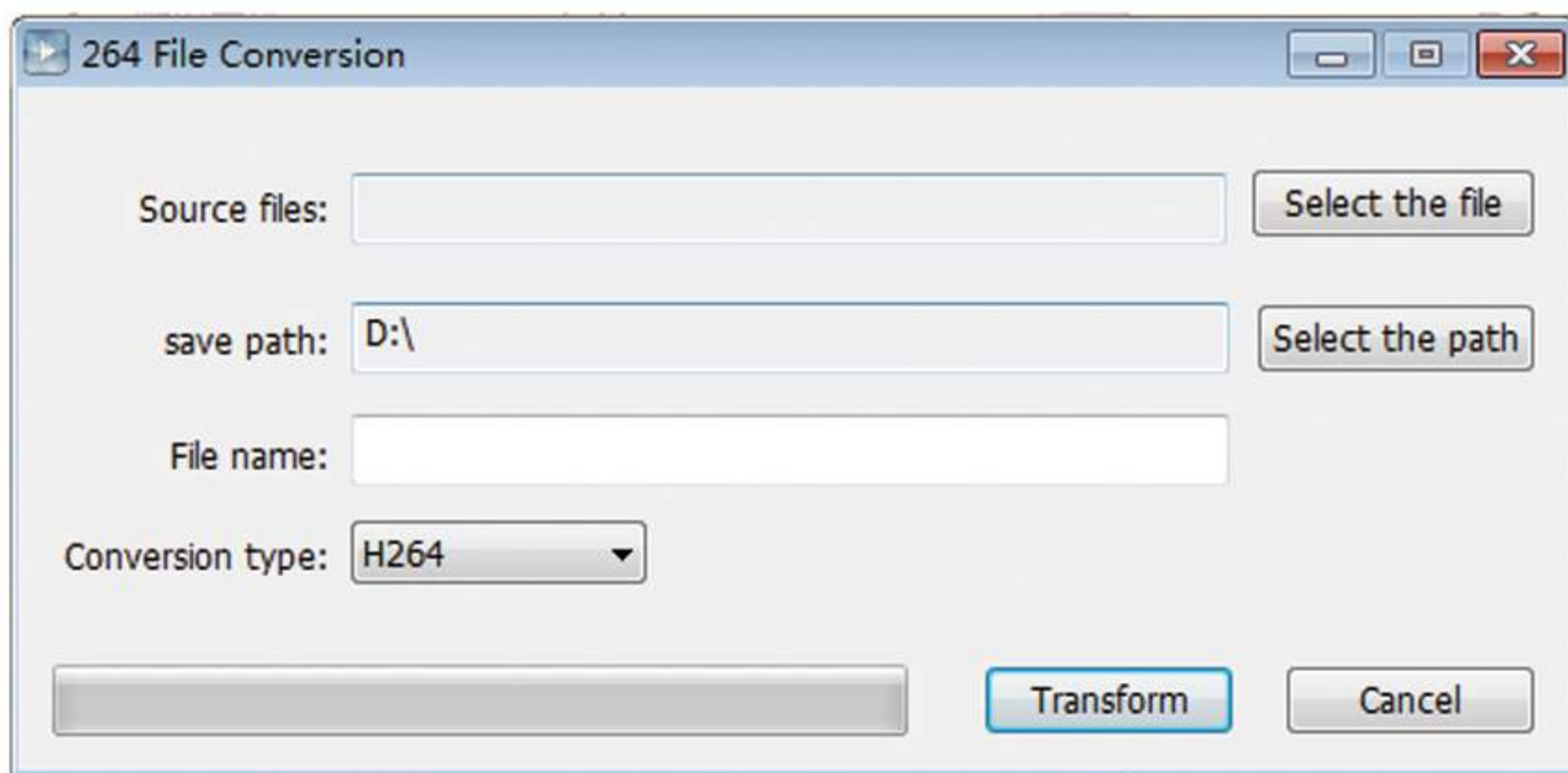

Operation steps:

Select the file: select the video file which need to convert.

Select the path : select the save path for the converted videos.

File name: the file name of the converted videos.

Conversion type: the type of the converted videos file(there are H.264, AVI, ASF), After all the setting is ready, then click “Transform” to covert it.

5. Restore the factory Settings

In current state, press the reset button to 20s, the camera will back to factory Settings. Also you can enter the mobile phone APP, PC client, or Internet explorer to restore factory Settings. Do not interrupt the power during the recovery process, after 5 minutes, power can be restarted. The videos stored in TF card still exist after restore, but all the setting are same as the factory setting. if you want to delete the videos of the TF card, please enter into the related APP or IE to format it.

6. upgrade

If the program has the new version and you want to update it. after receiving the specified program, Entering into the main video main interface through IE browser , choose parameter Settings-system Settings-initial setup-select file to upgrade.

7. The functions for 4G camera

FDD:B1,B3,B7,B8,B20 TD:B38,B40,B41

3G WCDMA:B1/B8 GSM:900/1800

The Apps of 4G dome camera are same as the normal wifi camera, both are "CamHi" and "P2PHI".



SIM card slot



check the device serial ID

Comment: The 4G camera can work as giving the power and was inserted the SIM card. Although RJ45 internet cable is exist, but it can't connect to the internet.

Option 1 for connection:

Supply power to the camera and insert the SIM card.

Check the device ID, User name, password from the sticker, then add the cameras by phone App(the steps please refer to page 3) or add the camera by PC App(refer to page 19-"method 3").

Option 2 for connection:

Supply power to the camera, but haven't insert the SIM card.

Find the AP from phone setting(as follow picture show). The connect way please refer to the Access point connection as previous instruction.



8. Access point

As the camera connect to the WIFI successful, the AP Model will disappear. Then if changed the router, or reset the wifi password, the camera will fail to connect to internet and the Access point also can't find. in this case, press the reset button to 20s to restore to factory setting, after 2 minutes, you can find the access point by phone again. first connect the camera under AP model, then set WIFI to make camera normal work again.(note: Don't interrupt the power as the restore in progress, otherwise it will damage the camera)

