

Wifi

Intelligent Solar Energy Alert PTZ Camera

User Manual



V2.3

1:PRODUCTS & PACKING LIST

1.1 Product picture:



1.2 Packing list:

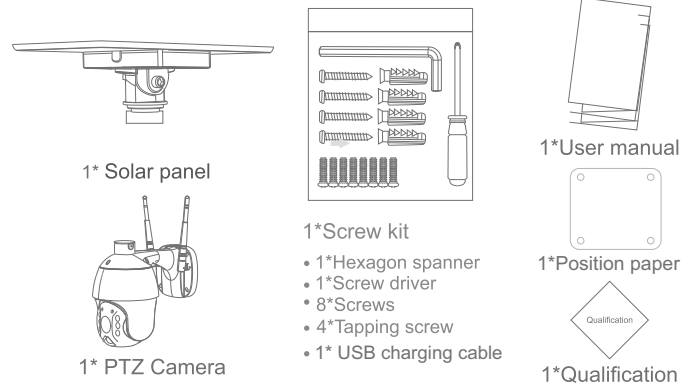

Product Diagram

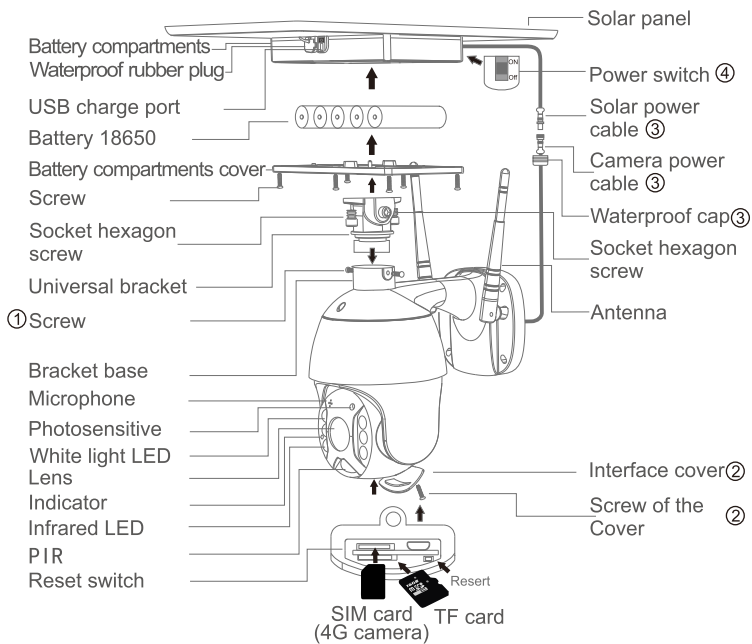

1.3 Process

- 1.3.1. Solar panel: connect panel to camera, fix a suitable angle with screws
- 1.3.2. Sim and TF card: loosening the cap in above remark
- 1.3.3. insert SIM card and TF card , then tightening the screws.. Power cable: connect the cables between the panel and camera, then tightening the waterproof cap.
- 1.3.4. Panel power-on: Remove the rubber of panel,make sure it is power on. Then put the rubber back to the panel.

2 .INSTALLATION

2.1 Intergrated installation

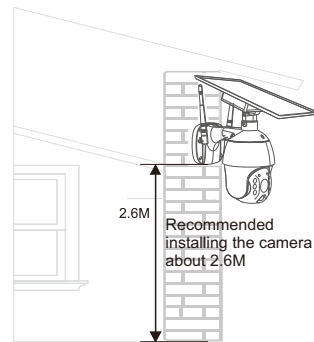

2.2 Separated installation

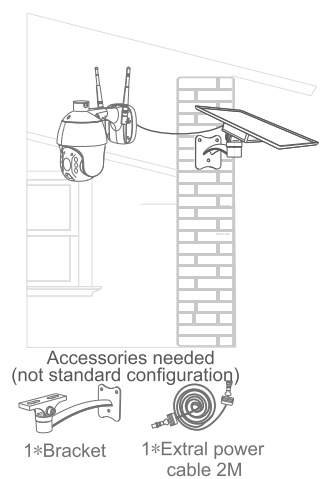

3. APP INSTALLATION

- 3.1. Scan the following QR codes or search for "UBox" from the App Store(for iOS devices) or Google Play Store (for Android smartphones) to download and install the app.



IOS



Android

3.2. APP REGISTRATION

- 3.2.1. Open the app then input your E-mail address then press 'Register'. Check and select to agree the agreement then your E-mail box will get an verification code.(For better user's experience, please allow to open all permissions to avoid missing any notifications from the app.)

- 3.2.2. Input the "Verification code" and press 'Next'. (if you not found the mail you might find the code in your email spam box.)

- 3.2.3. Set the login password and confirm the login password. Then press 'Register' to next step. (For your password safety, the password requires more than 8 characters plus a combination of letters)
- 3.2.4. Enter your E-mail address, and input your login password. Then press 'Login'.

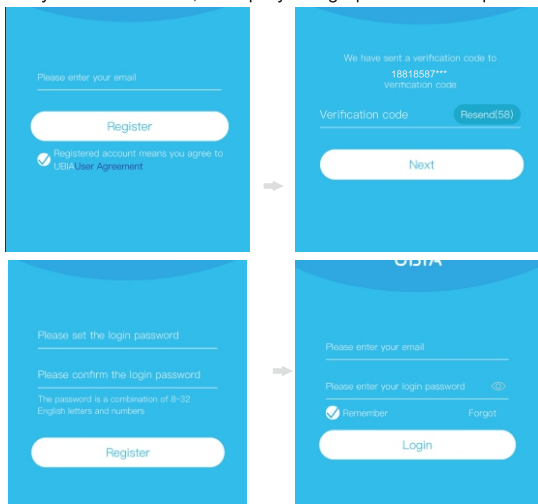

4. WI-FI CONNECTION

- 4.1. Press 'Add Family' then set the room or position as per reminders.
- 4.2. Enter your family name and then press 'Next'.
- 4.3. Input the necessary information just like Country, Province, then press 'Done'.
- 4.4. Press 'Add a device' to add a smart device

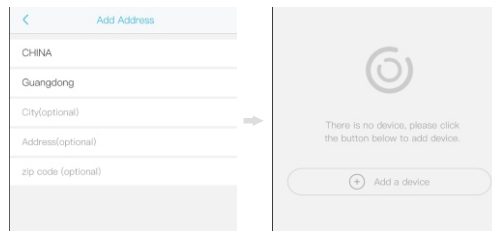
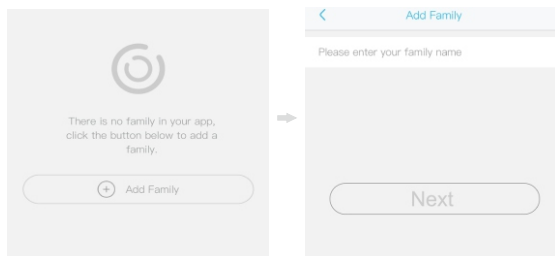

- 4.5. Connect the device with power supply, and make sure your mobile phone is disconnected to an available Wi-Fi. Then press 'Setup device'
- 4.6. After the power on the device, wait for the blue LED and voice prompt. The device is waiting for pairing, which means your device is in pairing mode.
- 4.7. If you did not hear the voice prompt, please press the RESET button until the blue indicator to light up and then release. The device will reboot and enter the pairing state.
- 4.8. The app will input the Wi-Fi name automatically, please input the correct Wi-Fi Password. Then you can choose the 'QR code configuration' or 'Sound wave configuration'.
- 4.9. Sound wave configuration: Make sure camera and mobile phone within 1M distance, you will hear the wave sound DI DI, follow the tips showed in the mobile to finish configuration.

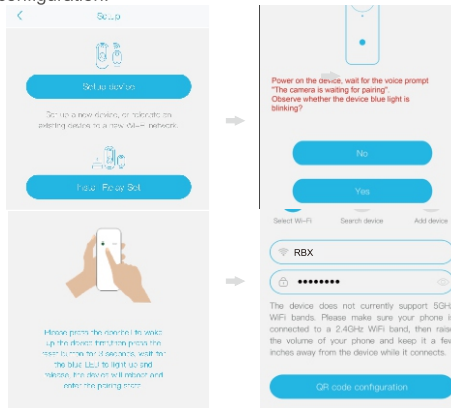

- 4.10. QR code configuration: Select the QR code configuration then the mobile phone display a QR code. Use the device to scan to the QR code 10cm away from the mobile phone.
- 4.11. Select the family name or device location then press 'Done.'
- 4.11. The device will enter to the device list automatically. Setup success! The device is ready to use.

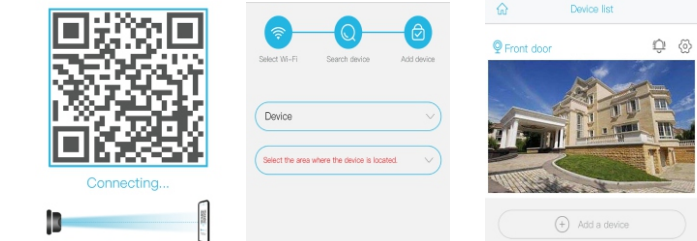

5. DEVICE SETTING

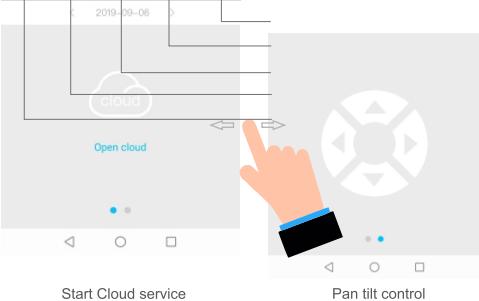
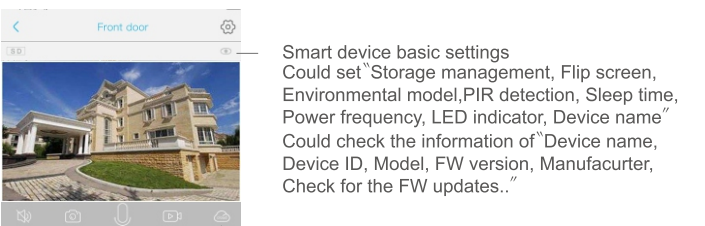
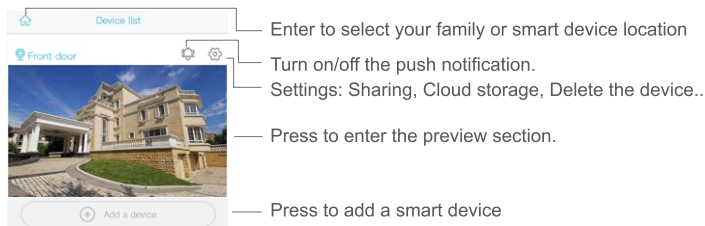

Start Cloud service

Pan tilt control

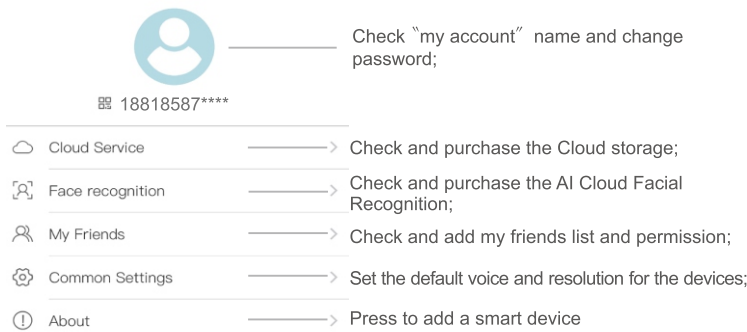

Click the "Calendar" icon on the right top corner, then choose the date to playback the videos from cloud storage.

Choose the desired date to check all videos from the cloud.

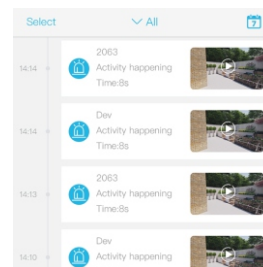
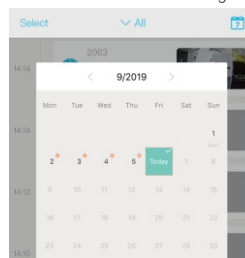

6. SPECIAL NOTES!

- 6.1. The device is equipped with a rechargeable lithium battery. The battery life will be affected by the device wake-up time and the number of wake-ups. Therefore, the PIR sensor alarm detection function is used in an environment with a lot of people. It is recommended to turn off or set the device to low sensitivity to reduce device wake-up and call times extend battery life. When the battery is low, please charge the battery immediately.
- 6.2. Keep the device in range of your router. Make sure the device is placed close to the Wi-Fi router. If there has to be thick or insulated objects between the device and the Wi-Fi router, which may lead to weak Wi-Fi signal, please make sure the Wi-Fi signal is in good level before you start using the device.
- 6.3. It is a delicate device with low power consumption design. Everytime the device is awakened and will work for few seconds. After that, the device will enter standby mode to save power. You can set the work time in the app settings.
- 6.4. Because the mainland China does not receive Google's system push messages, you need to open the app's self-starting function in your phone to receive push messages.
- 6.5. This device provides one month of free cloud storage services. If you need to continue using value-added services after the trial period expires, you need to purchase them in the app.

4G

Intelligent Solar Energy Alert PTZ Camera

User Manual



V2.3

1:PRODUCTS & PACKING LIST

1.1 Product picture:



1.2 Packing list:

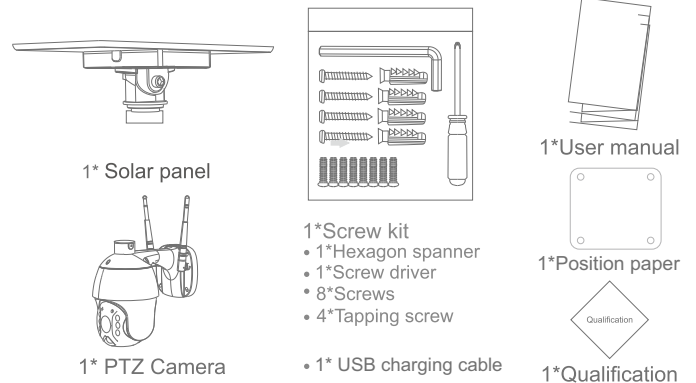

Product Diagram

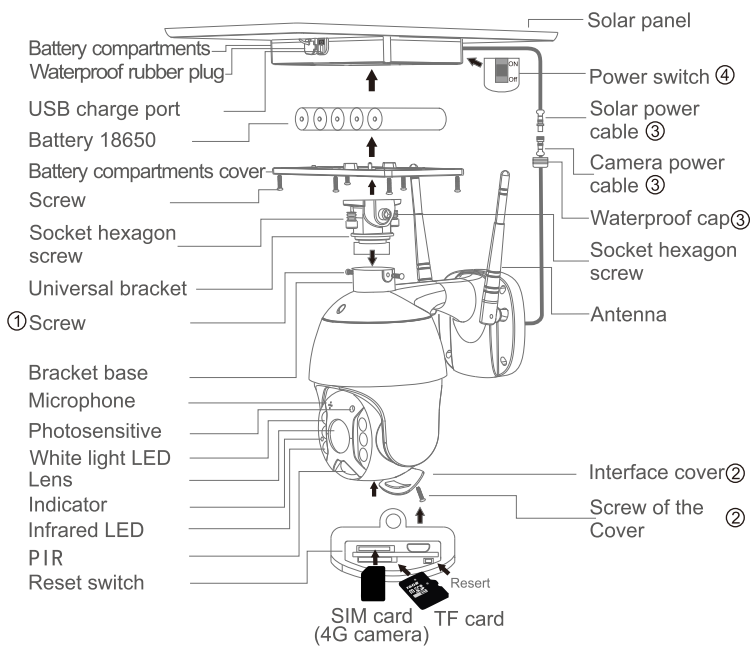

1.3 Process

- 1.3.1. Solar panel: connect panel to camera, fix a suitable angle with screws
- 1.3.2. Sim and TF card: loosening the cap in above remark
- 1.3.3. insert SIM card and TF card , then tightening the screws.. Power cable: connect the cables between the panel and camera, then tightening the waterproof cap.
- 1.3.4. Panel power-on: Remove the rubber of panel,make sure it is power on. Then put the rubber back to the panel.

2 .INSTALLATION

2.1 Intergrated installation

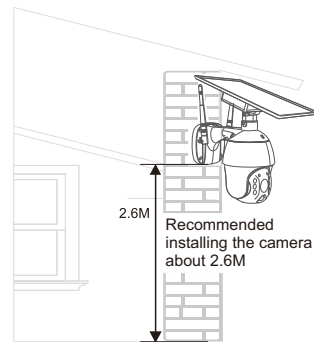

2.2 Separated installation

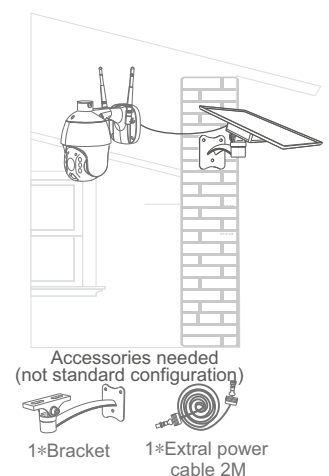

3. APP INSTALLATION

- 3.1. Scan the following QR codes or search for "UBox" from the App Store(for iOS devices) or Google Play Store (for Android smartphones) to download and install the app.



IOS



Android

3.2. APP REGISTRATION

- 3.2. 1.Open the app then input your E-mail address then press 'Register'. Check and select to agree the agreement then your E-mail box will get an verification code.(For better user's experience, please allow to open all permissions to avoid missing any notifications from the app.)

- 3.2. 2. Input the "Verification code" and press 'Next'. (if you not found the mail you might find the code in your email spam box.)

3.2.3. Set the login password and confirm the login password. Then press 'Register' to next step. (For your password safety, the password requires more than 8 characters plus a combination of letters)

3.2.4. Enter your E-mail address, and input your login password. Then press 'Login'.

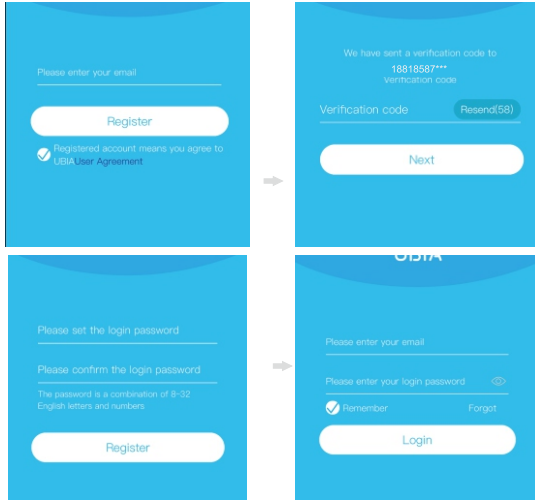

4. WI-FI CONNECTION

- 4.1. Press 'Add Family' then set the room or position as per reminders.
- 4.2. Enter your family name and then press 'Next'.
- 4.3. Input the necessary information just like Country, Province, then press 'Done'.
- 4.4. Press 'Add a device' to add a smart device

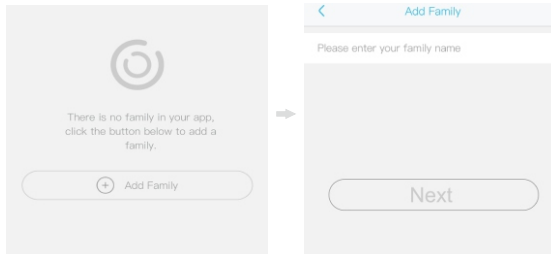

- 4 -

4.11. The device will enter to the device list automatically. Setup success! The device is ready to use.

4.12. Notes about PIR detection

*User can change the PIR detection sensitivity in device settings. we recommend to set sensitivity at "Disabled" or "Low" to reduce false alert and save the battery power in noisy environments.

*Disabled: disabled PIR detection.

*Low: delay 7 seconds PIR detects a moving.

*Medium: delay 5 seconds PIR detects a moving.

*High: delay 1 second PIR detects a moving.

5. DEVICE SETTING

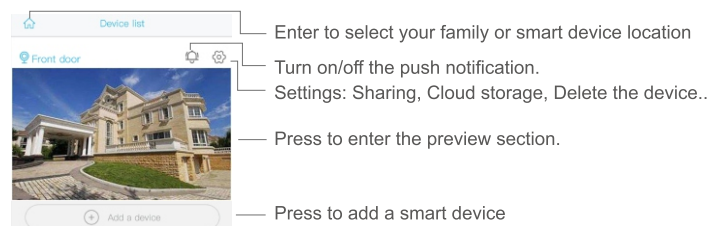

- Enter to select your family or smart device location
- Turn on/off the push notification.
- Settings: Sharing, Cloud storage, Delete the device..
- Press to enter the preview section.
- Press to add a smart device

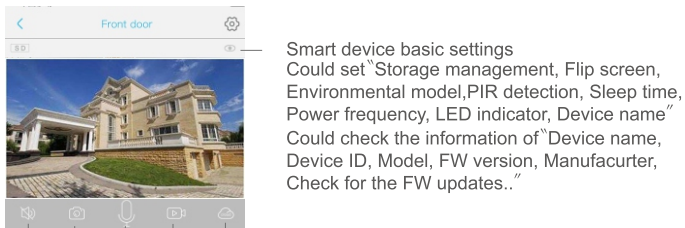

Smart device basic settings
Could set "Storage management, Flip screen, Environmental model, PIR detection, Sleep time, Power frequency, LED indicator, Device name"
Could check the information of "Device name, Device ID, Model, FW version, Manufacturer, Check for the FW updates.."

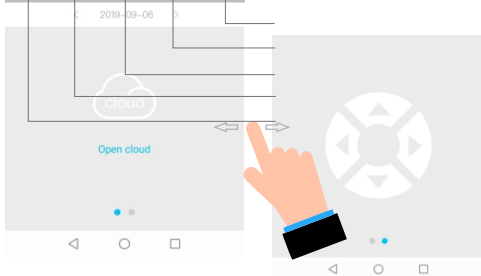

Start Cloud service

Pan tilt control

- 6 -

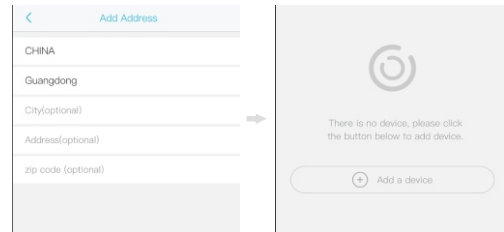

- 4.5. insert the SIM card into device then put the battery into the device, and some of models need install antenna.
- 4.6. After the power on the device, wait for about 1 minute the device blue LED light up Then press next.
- 4.7. If the device blue LED not light up, please check below config notes.
- 4.8. Find the UID QR code on device, then use APP scan the QR code.

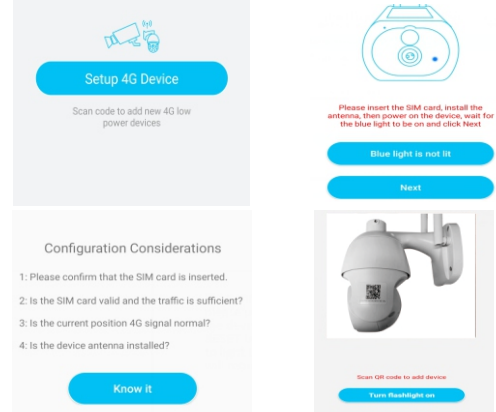

- 4.9. APP are search the device in internet it may take 5-60 seconds.
- 4.10. Select the name and device location then press 'Done.'

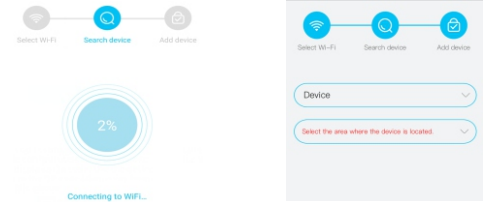

- 5 -



18818587****

Check "my account" name and change password;

- Cloud Service → Check and purchase the Cloud storage;
- Face recognition → Check and purchase the AI Cloud Facial Recognition;
- My Friends → Check and add my friends list and permission;
- Common Settings → Set the default voice and resolution for the devices;
- About → Press to add a smart device

Click the "Calendar" icon on the right top corner, then choose the date to playback the videos from cloud storage.

Choose the desired date to check all videos from the cloud.

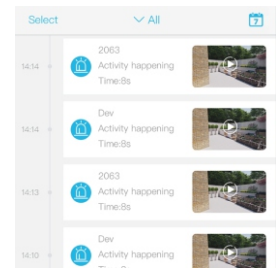
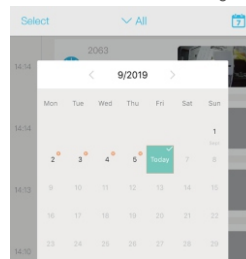

6. SPECIAL NOTES!

- 6.1. The device is equipped with a rechargeable lithium battery. The battery life will be affected by the device wake-up time and the number of wake-ups. Therefore, the PIR sensor alarm detection function is used in an environment with a lot of people. It is recommended to turn off or set the device to low sensitivity to reduce device wake-up and call times extend battery life. When the battery is low, please charge the battery immediately.
- 6.2. Keep the device in range of your router. Make sure the device is placed close to the Wi-Fi router. If there has to be thick or insulated objects between the device and the Wi-Fi router, which may lead to weak Wi-Fi signal, please make sure the Wi-Fi signal is in good level before you start using the device.
- 6.3. It is a delicate device with low power consumption design. Everytime the device is awakened and will work for few seconds. After that, the device will enter standby mode to save power. You can set the work time in the app settings.
- 6.4. Because the mainland China does not receive Google's system push messages, you need to open the app's self-starting function in your phone to receive push messages.
- 6.5. This device provides one month of free cloud storage services. If you need to continue using value-added services after the trial period expires, you need to purchase them in the app.

- 7 -